

Jets



Leandro G. Almeida

Prospects for New Colliders, June 4, 2012



Outline

- Jets Definitions
 - Algorithms
 - Iterative Cones
 - Sequential Algorithms
 - Infrared Properties
- Jet Properties
 - Pt Distribution
 - Mass Distribution

Introduction

Partons to Jets: We tend to discuss QCD in terms of quarks and gluons, yet we only measure hadrons

After being produced partons quickly fragment and hadronize, leading to a collimated spray of hadrons

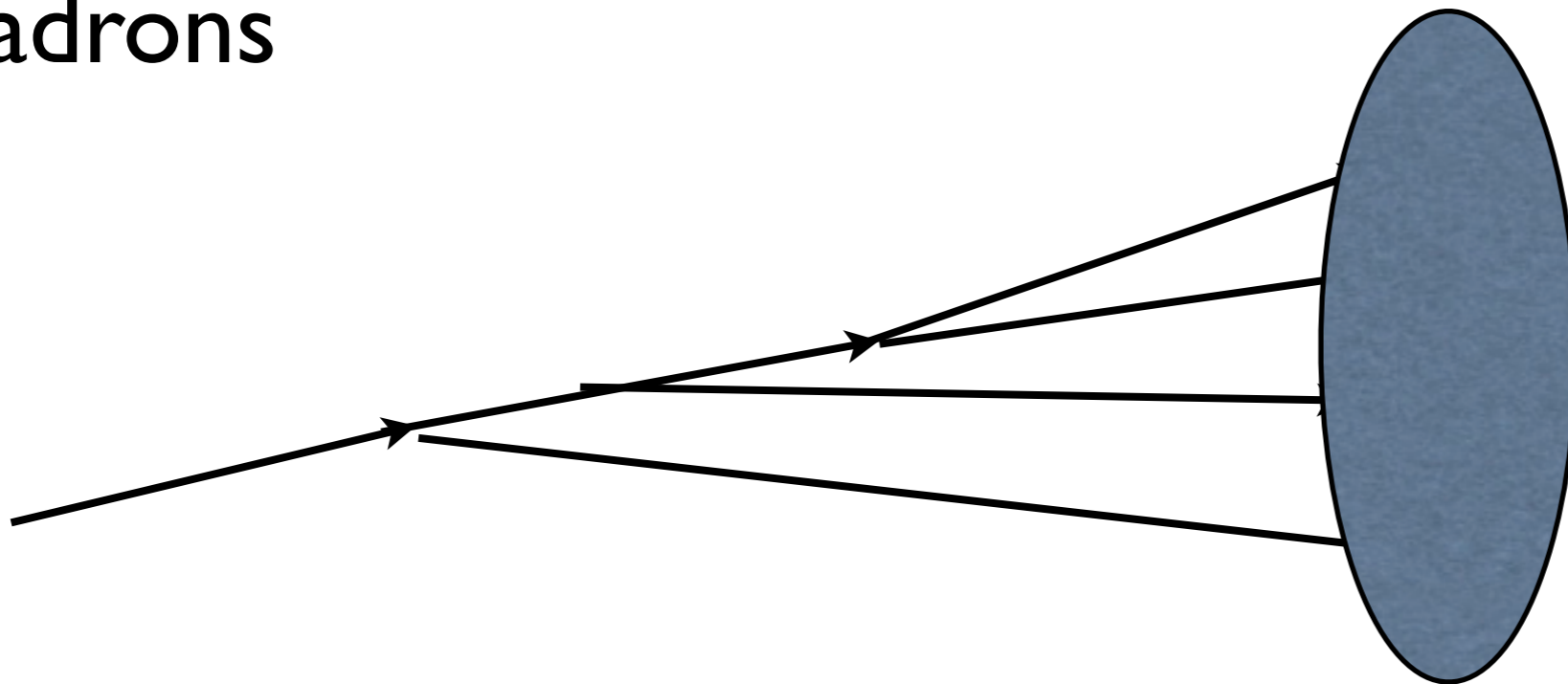

Jet Event

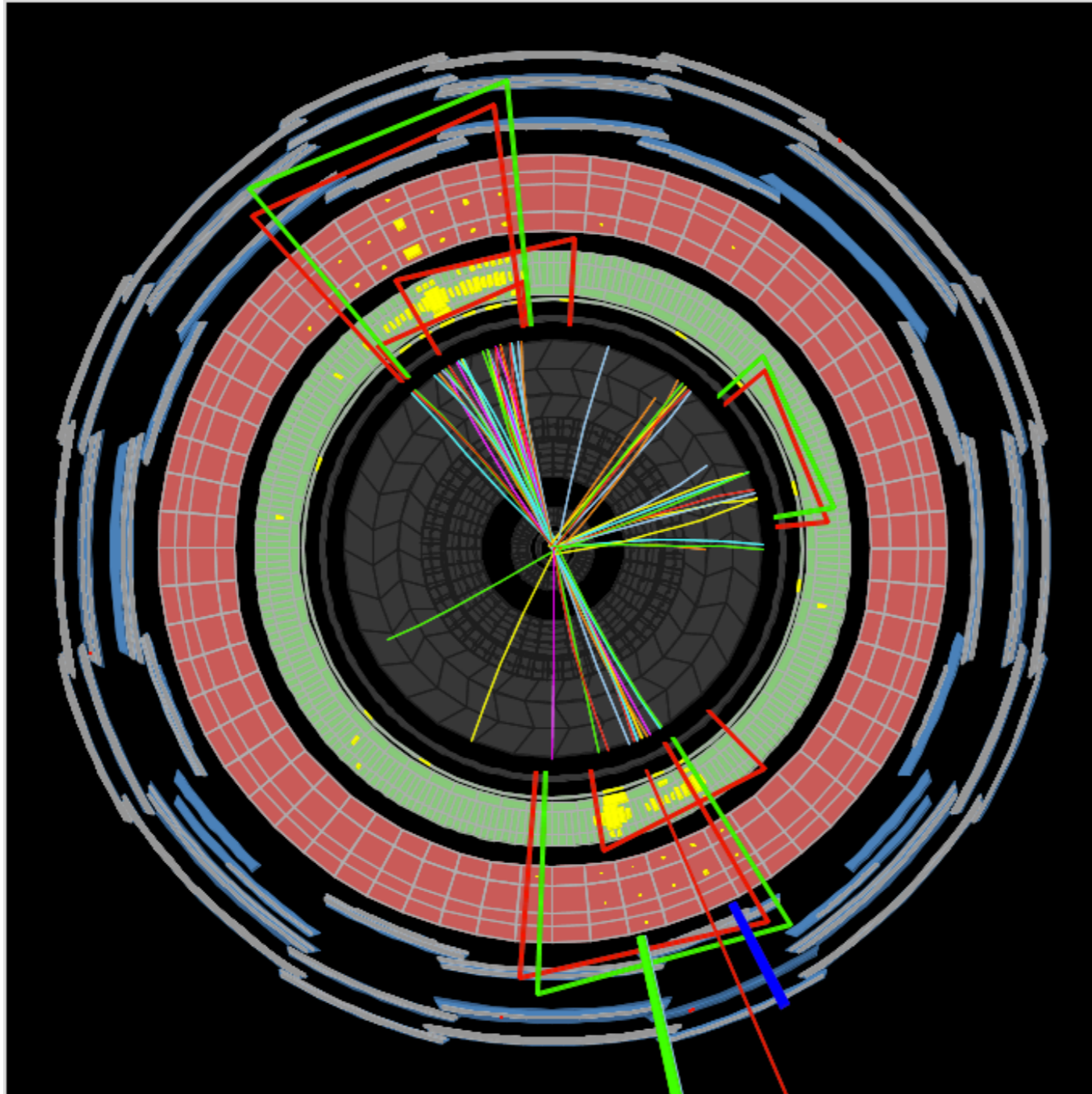

Jets as Avatars

To a large extent, jets are meant to be proxies for partons.

However the concept of partons is a bit ambiguous.

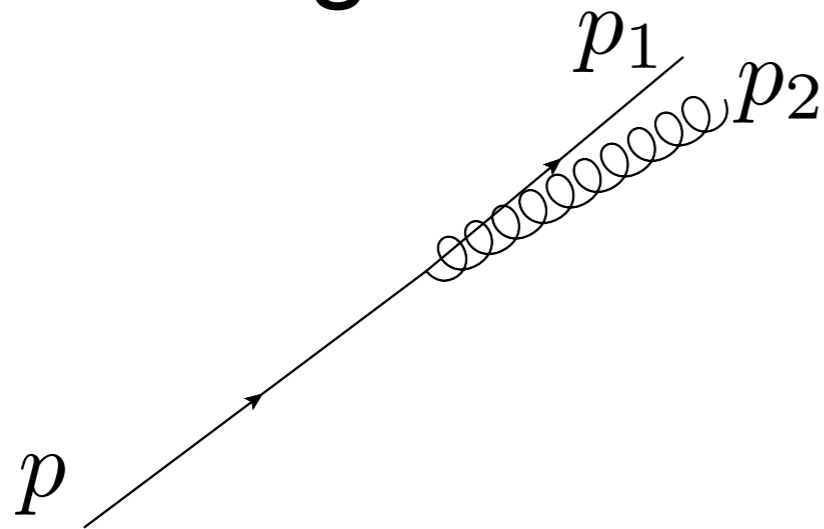

Collinear Splitting

$$p = p_1 + p_2$$

$$p_1 = zp_2$$

Their branching, or splitting probabilities are divergent implies one needs a regularization, or prescription for defining what exactly one means by a parton

$$\int \frac{d\theta_{12}^2}{\theta_{12}^2} \int_0^1 dz \alpha_s P_{qq}(z)$$

And this where jets come in : Defining what we mean by a jet will give us a natural prescription for defining partonic cross-sections.



Once we understand the algorithms , currently used to define jets and how they behave, we will address the methods in performing some physics analysis

Snowmass accord set out some general desired properties of jet algorithms

Toward a Standardization of Jet Definitions *

Published Proceedings of the 1990 Summer Study on High Energy Physics -
Research Directions for the Decade - Snowmass, Colorado, June 25-July 13, 1990.

Several important properties that should be met by a jet definition are
[3]:

1. Simple to implement in an experimental analysis;
2. Simple to implement in the theoretical calculation;
3. Defined at any order of perturbation theory;
4. Yields finite cross section at any order of perturbation theory;
5. Yields a cross section that is relatively insensitive to hadronization.

So I will try to give an overview of the algorithms, developed in the mean time (not really) and some of the problems they encounter

IR divergences

The x-sections for production of quarks and gluons

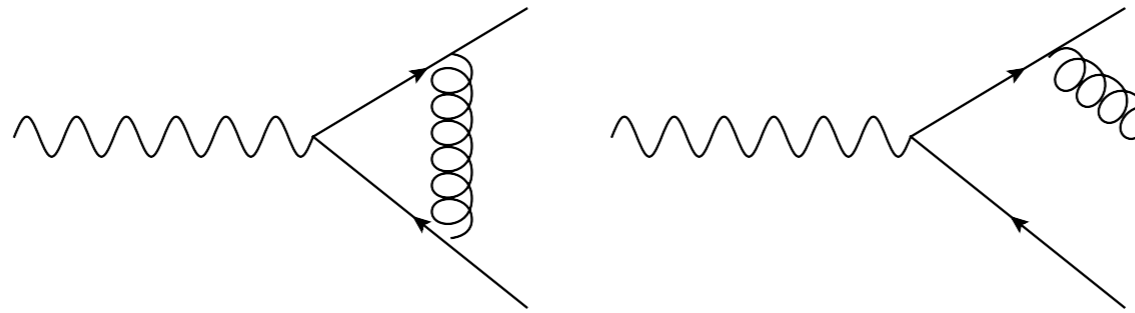

After integrating over loop mtm , and renormalizing UV diverg. We are left over with IR divergences, that are only cancelled when we integrate over the phase space of real interactions.

How much of the phase spc. must we integrate over ??

IR divergences

Sterman, Weinberg Jets

In pQCD is enough to place a cone around the quarks with an opening angle, δ

As long as these jets have $1 - \epsilon$ of the energy of the event

δ, ϵ are parameters of jet algorithm

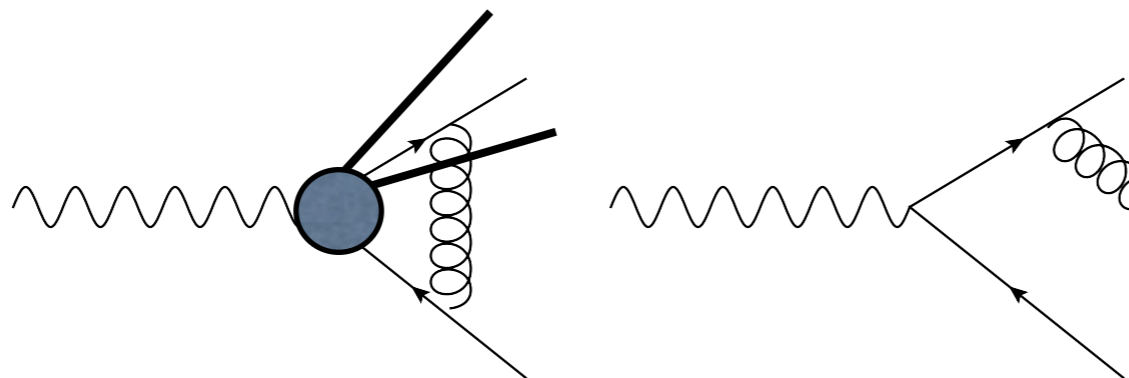

Experimentally, it isn't always obvious to where place the cones.

Given a set of 4-mtm can YOU find the jet axis ?

How do I measure, or deal with, overlapping jets ?

- 1) Try to find the correct (stable) Jet axis
- 2) USE ALL Possible Jet axes
- 3) No Jet axis (a priori)

The Iterative Cones

Or where do I place my cone ?

- 1) Pick one pcle as seed, call that the jet axis
- 2) Sum the mtm of all pcles within a cone, or circle in the (y, ϕ) - plane, of size R .

$$\Delta R_{ij}^2 = (y_i - y_j)^2 + (\phi_i - \phi_j)^2 < R$$

- 3) Use the sum of mtm as the new seed, jet axis.
keep doing until you have stable cone

R now replaces the cone opening angle, δ

What Should I use the initial seed, or the next seed once I find a jet ??

What to do when they overlap ?

possible solution: Forgetaboutit

IC- Progressive Removal, “UA1”-type

Hardest pcle is the first seed.

Once a stable cone is found
remove all pcles in the jet.

Hardest pcle is the next seed.



Unfortunately it's Infrared Unsafe...

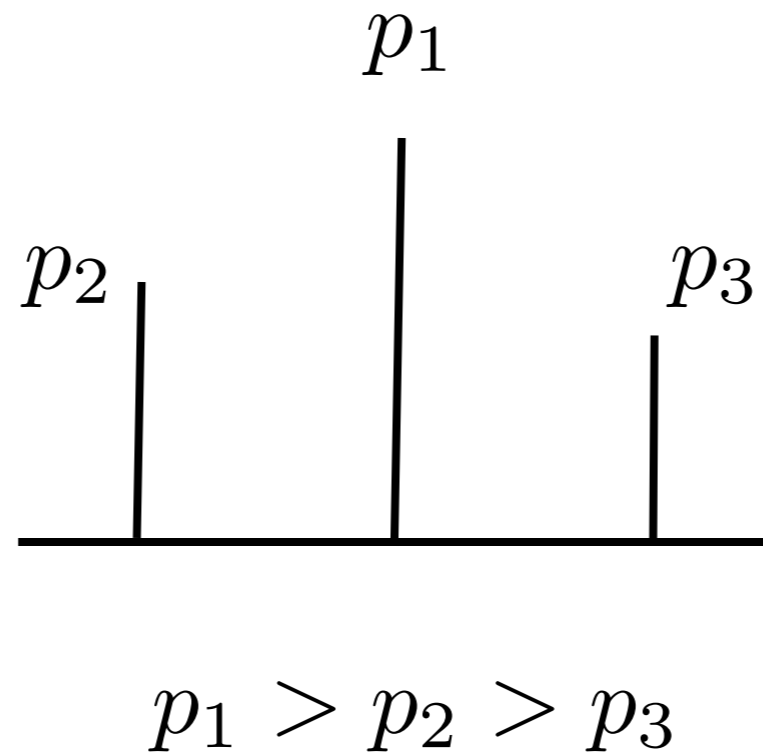

Unfortunately it's Infrared Unsafe...

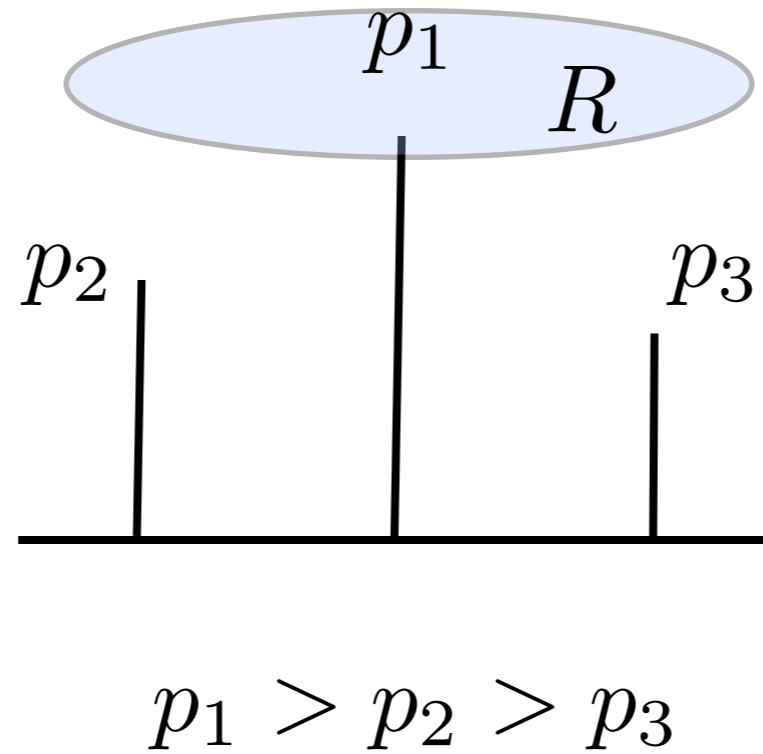

Unfortunately it's Infrared Unsafe...

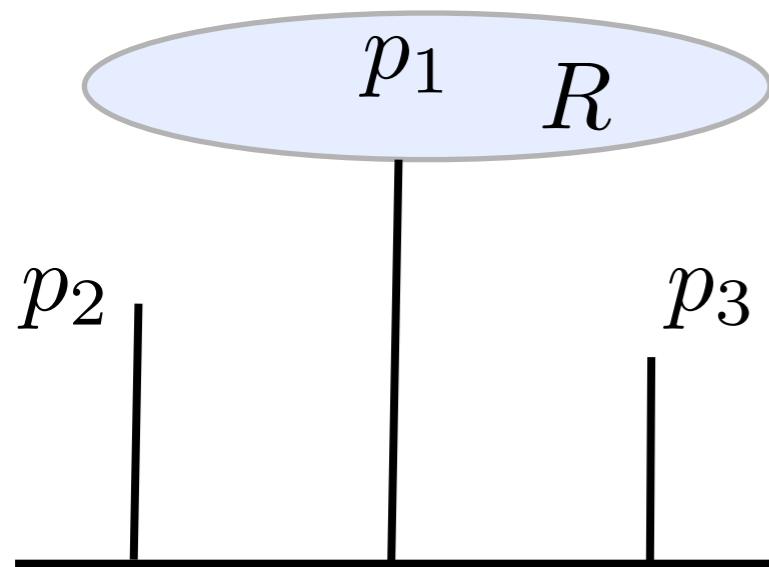

$$p_1 > p_2 > p_3$$

Collinear Split

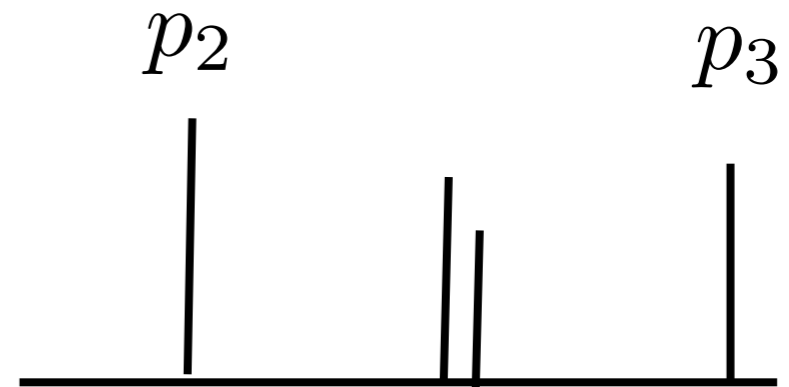

$$p_1 = p_{1a} + p_{1b}$$

$$p_{1a} \sim z p_{2a}$$

$$p_1 > p_2 > p_3 > p_{1a}, p_{1b}$$

Unfortunately it's Infrared Unsafe...

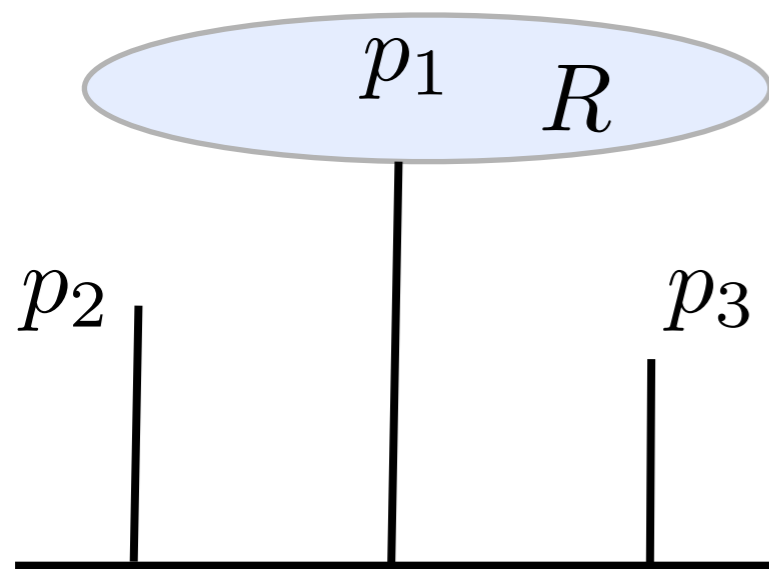

$$p_1 > p_2 > p_3$$

Collinear Split

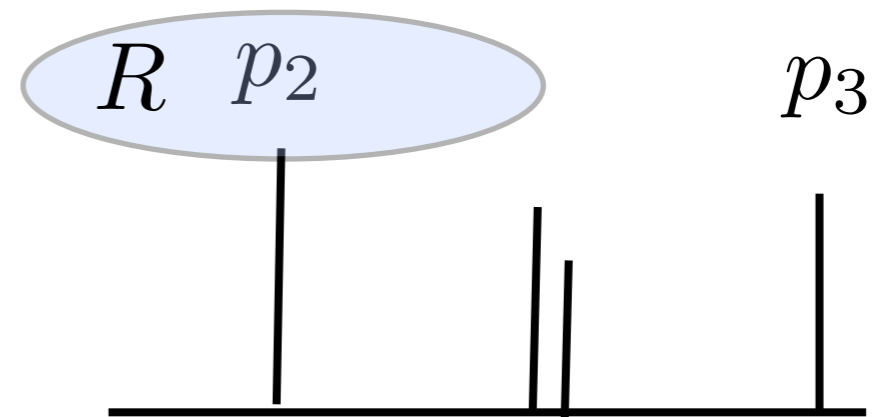

$$p_1 = p_{1a} + p_{1b}$$

$$p_{1a} \sim z p_{2a}$$

$$p_1 > p_2 > p_3 > p_{1a}, p_{1b}$$

Unfortunately it's Infrared Unsafe...

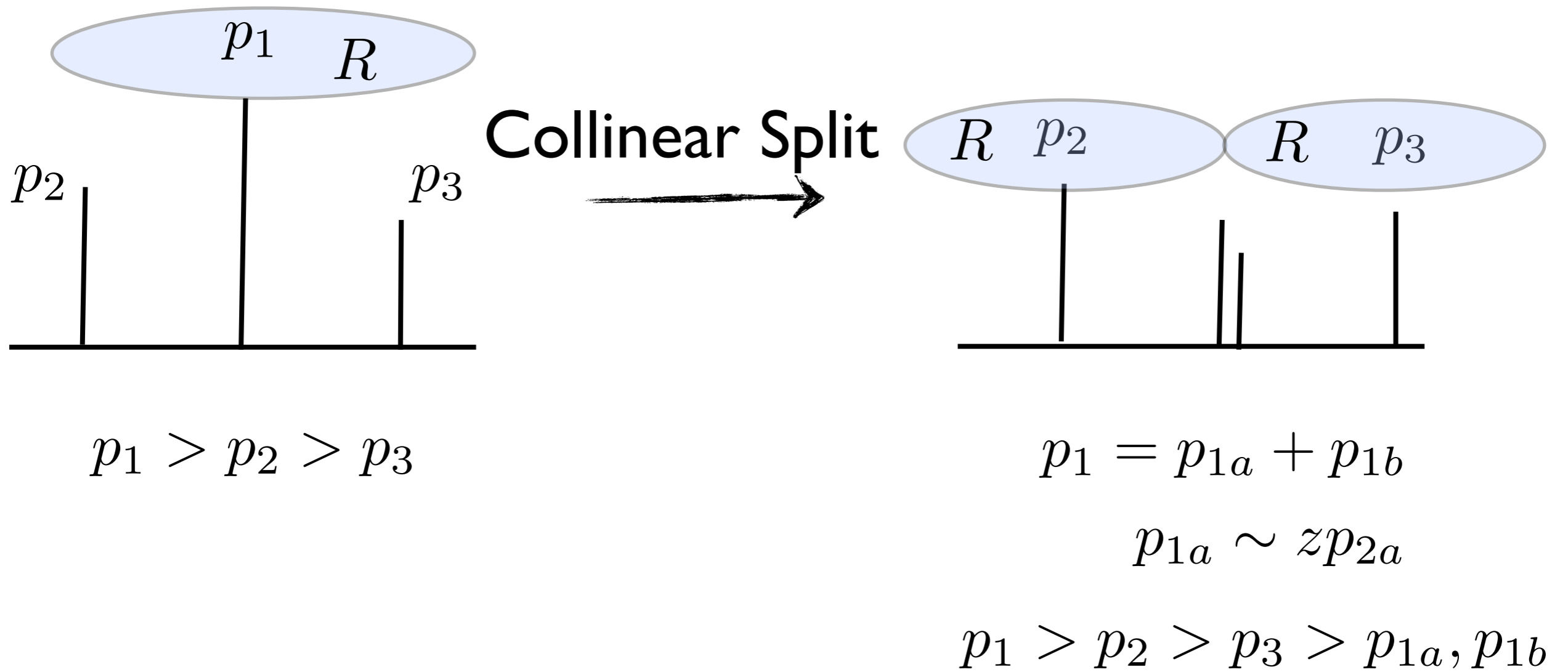

IR Cancellations

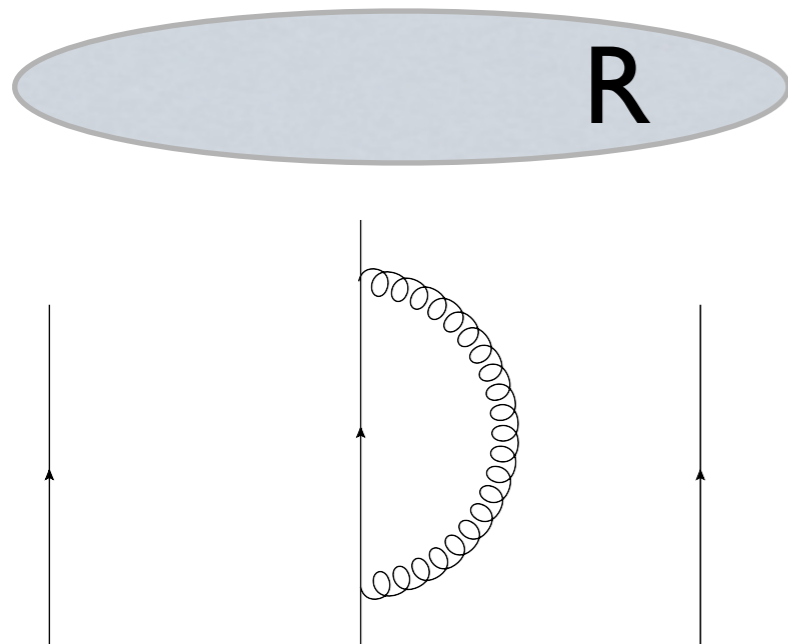

Virtual Correction

$$\alpha_s \times \infty$$

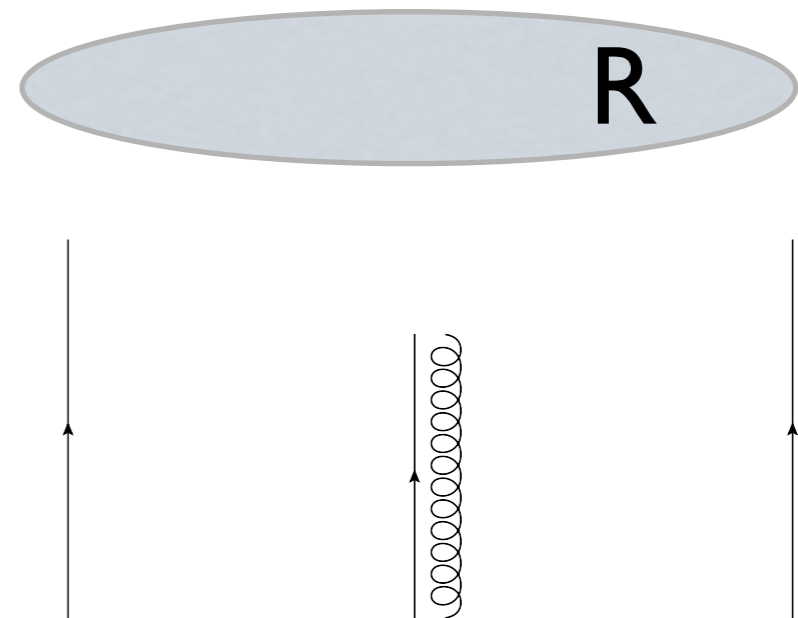

Real Correction

$$-\alpha_s \times \infty$$

In pQCD at a fixed order, after integration of the loop mtm, any infinities need to cancel with the ones coming from the real corrections.

IR Cancellations

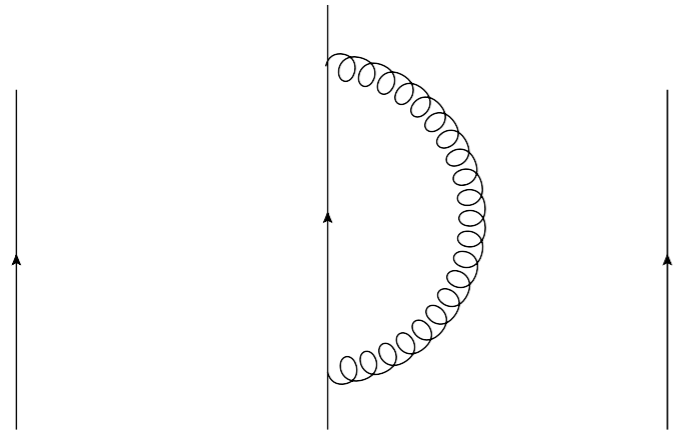

IC-PR

Virtual Correction

$$\alpha_s \times \infty$$

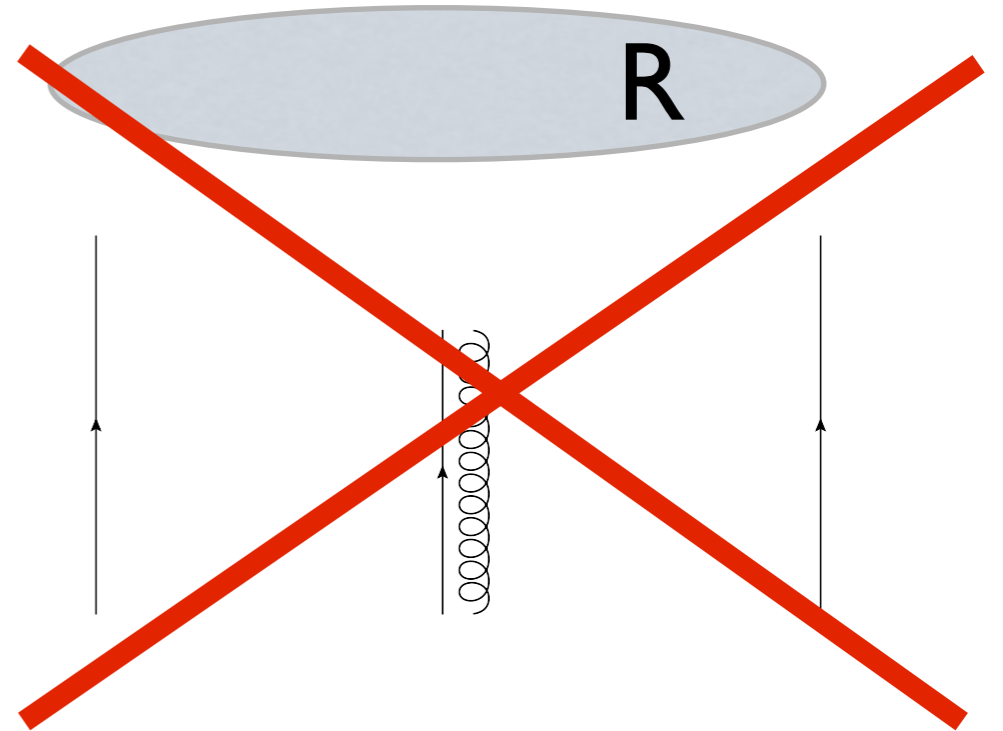

Real Correction

$$-\alpha_s \times \infty$$

IC-Split Merge

1) Find ALL stable cones

Now some pcles will be shared btw jets

2) Apply Split-Merge:

Merge two jets if they share more than a fraction f of the softer cone's transverse mtm

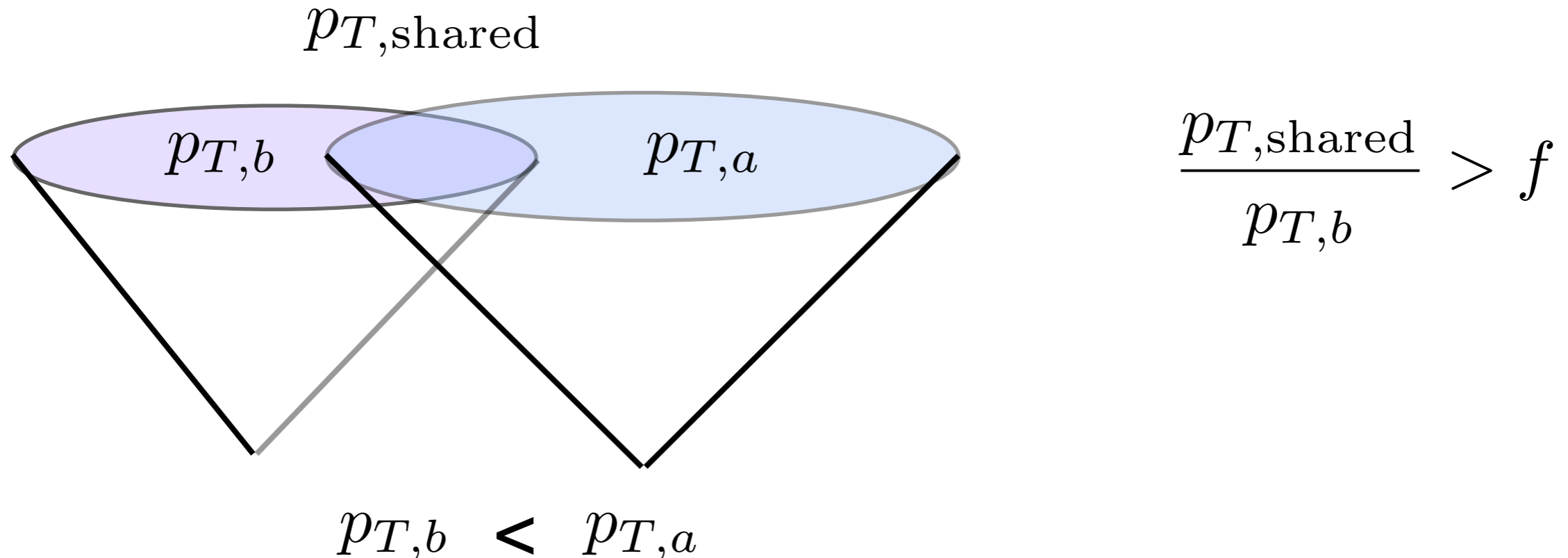

Also IC-Split Drop

Where if the criteria is met, the pcles of the softer jet that are not shared are not merged but are simply dropped

Nonetheless, IC-SM type also have IR problems

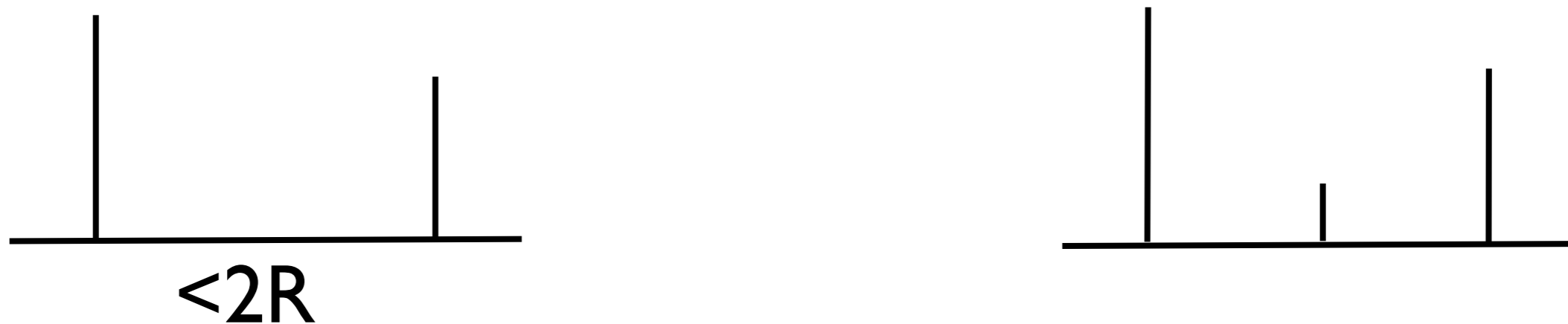

Addition of soft mtm causes the jet algorithm to find new stable cones

Also IC-Split Drop

Where if the criteria is met, the pcles of the softer jet that are not shared are not merged but are simply dropped

Nonetheless, IC-SM type also have IR problems

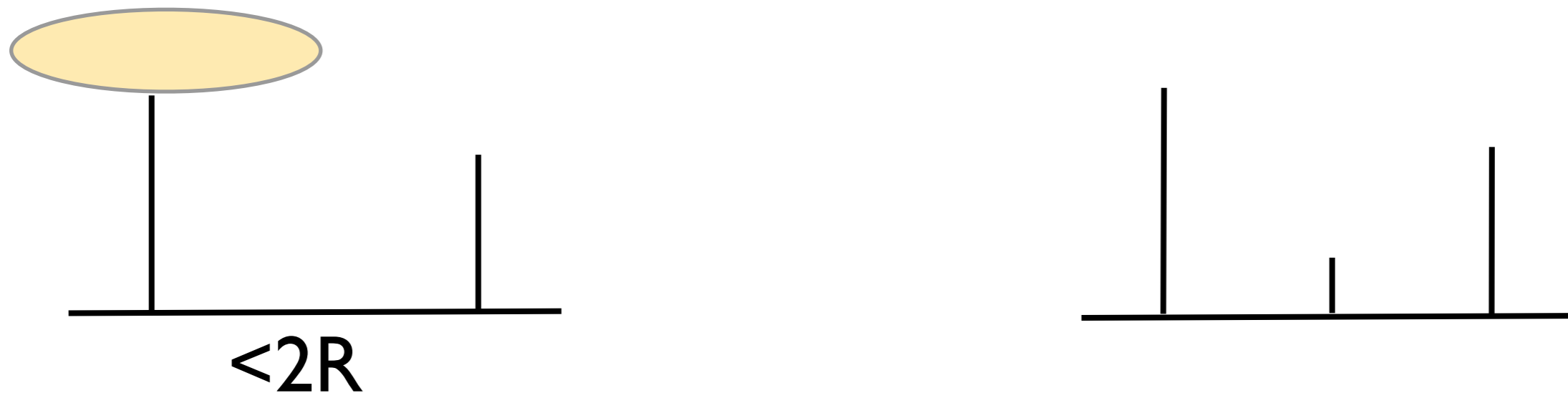

Addition of soft mtm causes the jet algorithm to find new stable cones

Also IC-Split Drop

Where if the criteria is met, the pcles of the softer jet that are not shared are not merged but are simply dropped

Nonetheless, IC-SM type also have IR problems



Addition of soft mtm causes the jet algorithm to find new stable cones

Also IC-Split Drop

Where if the criteria is met, the pcles of the softer jet that are not shared are not merged but are simply dropped

Nonetheless, IC-SM type also have IR problems



Addition of soft mtm causes the jet algorithm to find new stable cones

Also IC-Split Drop

Where if the criteria is met, the pcles of the softer jet that are not shared are not merged but are simply dropped

Nonetheless, IC-SM type also have IR problems

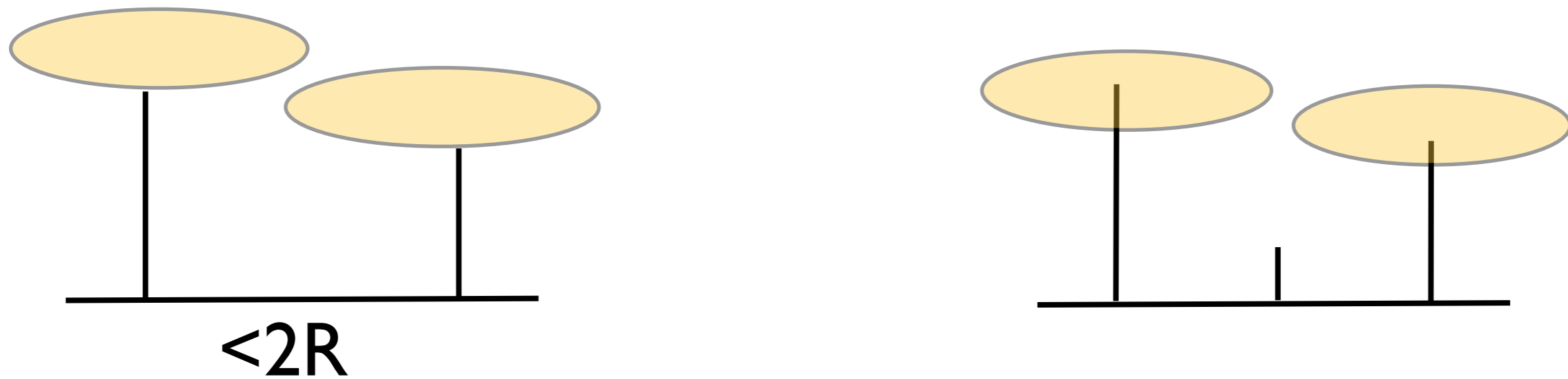

Addition of soft mtm causes the jet algorithm to find new stable cones

Also IC-Split Drop

Where if the criteria is met, the pcles of the softer jet that are not shared are not merged but are simply dropped

Nonetheless, IC-SM type also have IR problems

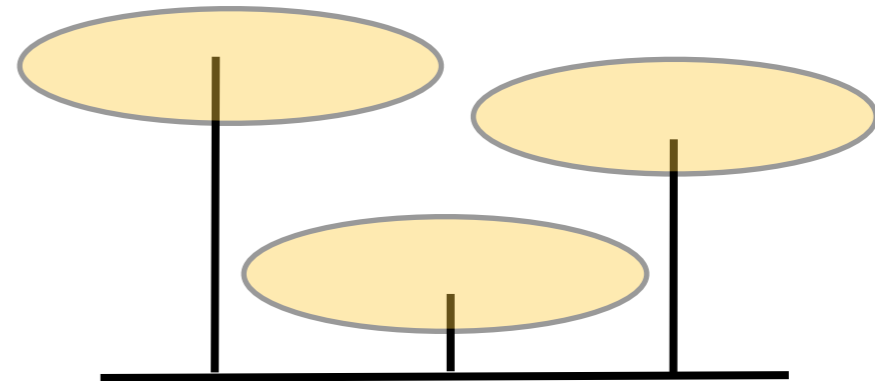
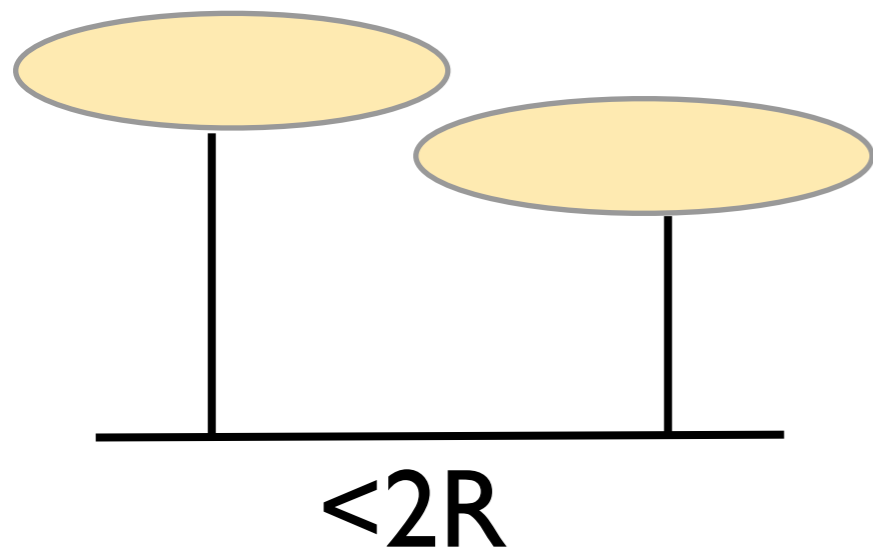

Addition of soft mtm causes the jet algorithm to find new stable cones

Also IC-Split Drop

Where if the criteria is met, the pcles of the softer jet that are not shared are not merged but are simply dropped

Nonetheless, IC-SM type also have IR problems

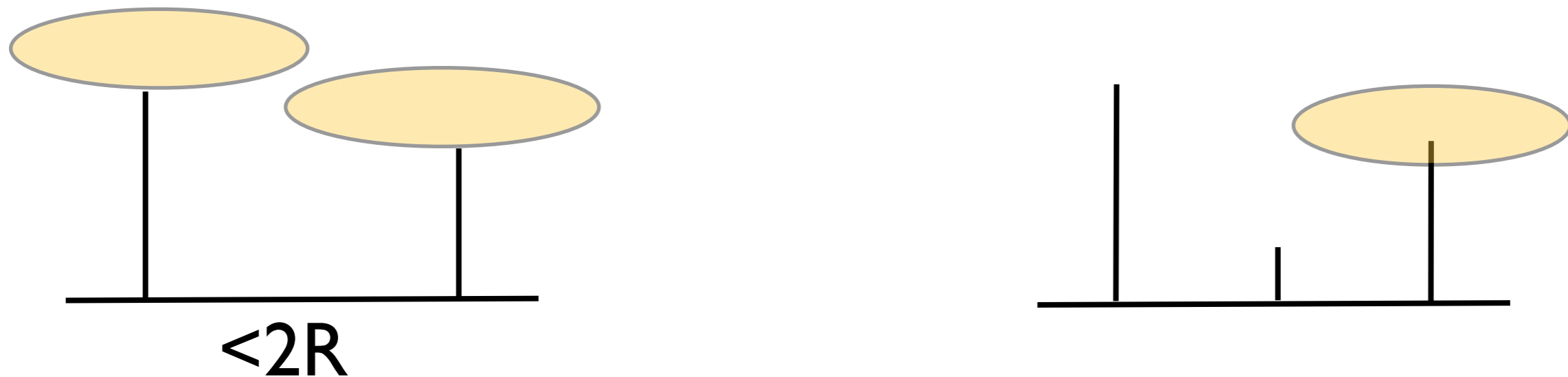

Addition of soft mtm causes the jet algorithm to find new stable cones

Also IC-Split Drop

Where if the criteria is met, the pcles of the softer jet that are not shared are not merged but are simply dropped

Nonetheless, IC-SM type also have IR problems

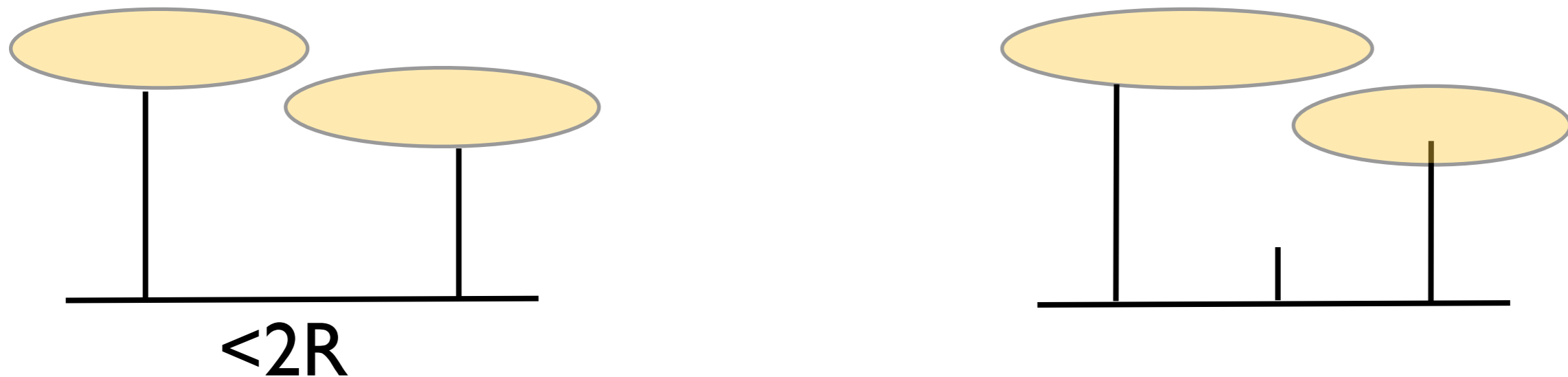

Addition of soft mtm causes the jet algorithm to find new stable cones

Also IC-Split Drop

Where if the criteria is met, the pcles of the softer jet that are not shared are not merged but are simply dropped

Nonetheless, IC-SM type also have IR problems

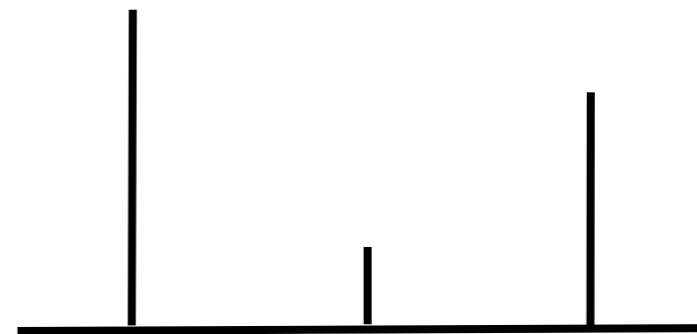
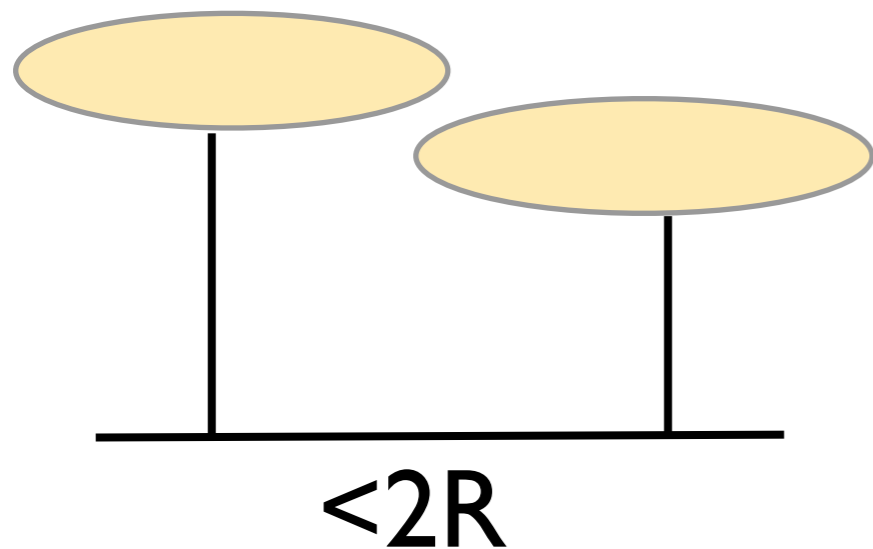

Addition of soft mtm causes the jet algorithm to find new stable cones

Also IC-Split Drop

Where if the criteria is met, the pcles of the softer jet that are not shared are not merged but are simply dropped

Nonetheless, IC-SM type also have IR problems



Addition of soft mtm causes the jet algorithm to find new stable cones

IC-SM with mid-point

Solution: MORE SEEDS! include the point btw jets as a new seed, now you remove the ambiguities at lower orders.

Problem ? Now all you have done is push the problem to higher orders.

IR unsafe measurements

What can one do with measurements that were done with IR unsafe methods ?

Depends on the size of effects due to IR unsafety

One can compare methods and see the size of differences when one uses different methods

Sequential Algorithms

JADE Algorithm:

No axis is chosen a priori

1) for each pair of pcles compute

$$y_{ij} = \frac{2E_i E_j}{Q^2} (1 - \cos \theta_{ij})$$

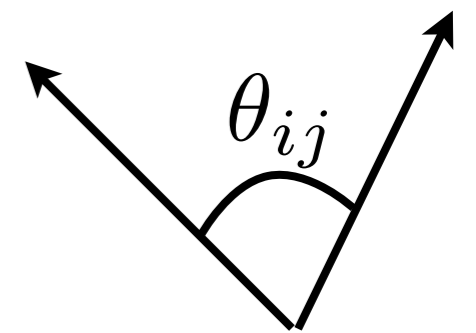

2) Find the smallest y_{ij} , if below some y_{cut} recombine i and j into a new particle.

3) Otherwise all remaining pcles are jets

JADE Algorithm

of jets that one finds depends on the value of

As y_{cut} is reduced, softer and more collinear emissions get resolved into jets into their own right.

It is completely IR safe since any collinear or soft emissions gets merged right at the start of the clustering.

Problem ? two very soft pcles, in opposite directions are recombined in a single jet at the beginning.

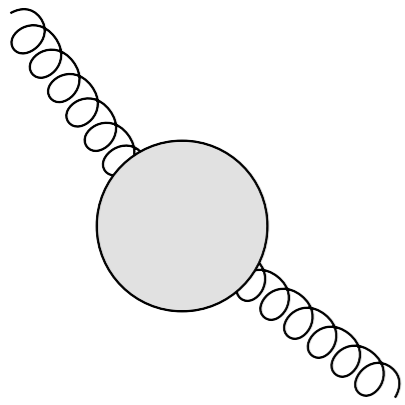

$$y_{ij} \sim E_i E_j$$

Emotionally disturbing

Leads to a non-trivial structure in higher-order calculations

k_T Algorithm

Don't use the particles mass , use their relative transverse momentum.

$$y_{ij} = \frac{2\min(E_i^2, E_j^2)}{Q^2} (1 - \cos \theta_{ij})$$

Using the minimal energy ensures that distance btw two soft back-to-back is larger than that between a soft particle and a hard one that's nearby in angle

Also Branching probabilities in QCD have a similar structure

$$\frac{dP_{k \rightarrow ij}}{dE_i d\theta_{ij}} \sim \frac{\alpha_S}{\min(E_i, E_j) \theta_{ij}}$$

This relation to the structure of QCD divergences, made it possible to carry out all-order resummation of the distribution in $y_{n,n+1}$

k_T Algorithm

for Hadronic Colliders

Total energy (at least in a pp collider) is not well defined

$$d_{ij} = \min(E_i, E_j)(1 - \cos \theta_{ij})$$

We can also introduce the idea of a beam Jet.

$$d_{iB} = E_i^2(1 - \cos \theta_{iB})$$

Now if : $d_{ij} > d_{iB}$

then we group i to the beam

In pp colliders one also tends to choose variables invariant under beam

boosts $d_{ij} = \min(k_{T,i}, k_{T,j}) \Delta R_{i,j}$

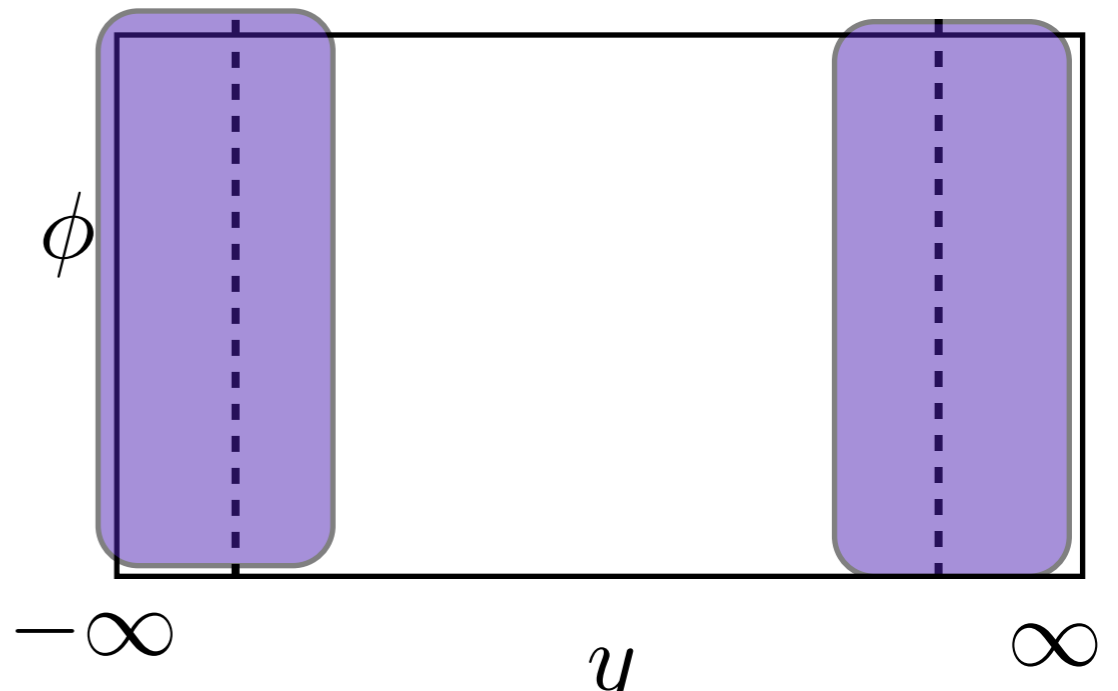

k_T Algorithm

inclusive case

$$d_{ij} = \min(k_{T,i}, k_{T,j}) \frac{\Delta R_{i,j}}{R} \quad d_{iB} = k_{T,i}$$

1) find the smallest d_{ij} d_{iB}

2a) if d_{ij} is the smallest, combine them

2b) if d_{iB} is smaller, then i becomes a jet on its own, and gets removed from lists of jets

No concept of beam jet

d_{cut} no longer exist, it is now determined by

R parameter

If pcle i has no other pcles within R , d_{iB} will be smaller and i becomes its own jet

Cambridge/Aecheh Algorithms

1) find the smallest, $d_{ij} = \frac{\Delta R_{i,j}}{R}$ $d_{iB} = k_{T,i}$

2) merge if $d_{ij} < d_{iB}$

Merging is done by geometrical distance and reconstructs the angle ordered emission.

Anti- k_T Algorithm

Generalizes

$$d_{ij} = \min(k_{T,i}^p, k_{T,j}^p) \frac{\Delta R_{i,j}}{R}$$

1) $p=1$ k_T Algorithm

2) $p=0$ C/A

3) $p=-1$ anti- k_T

Unlike the k_T algorithm, it starts group hard particles first, then slowly building up the jet.

Branching History

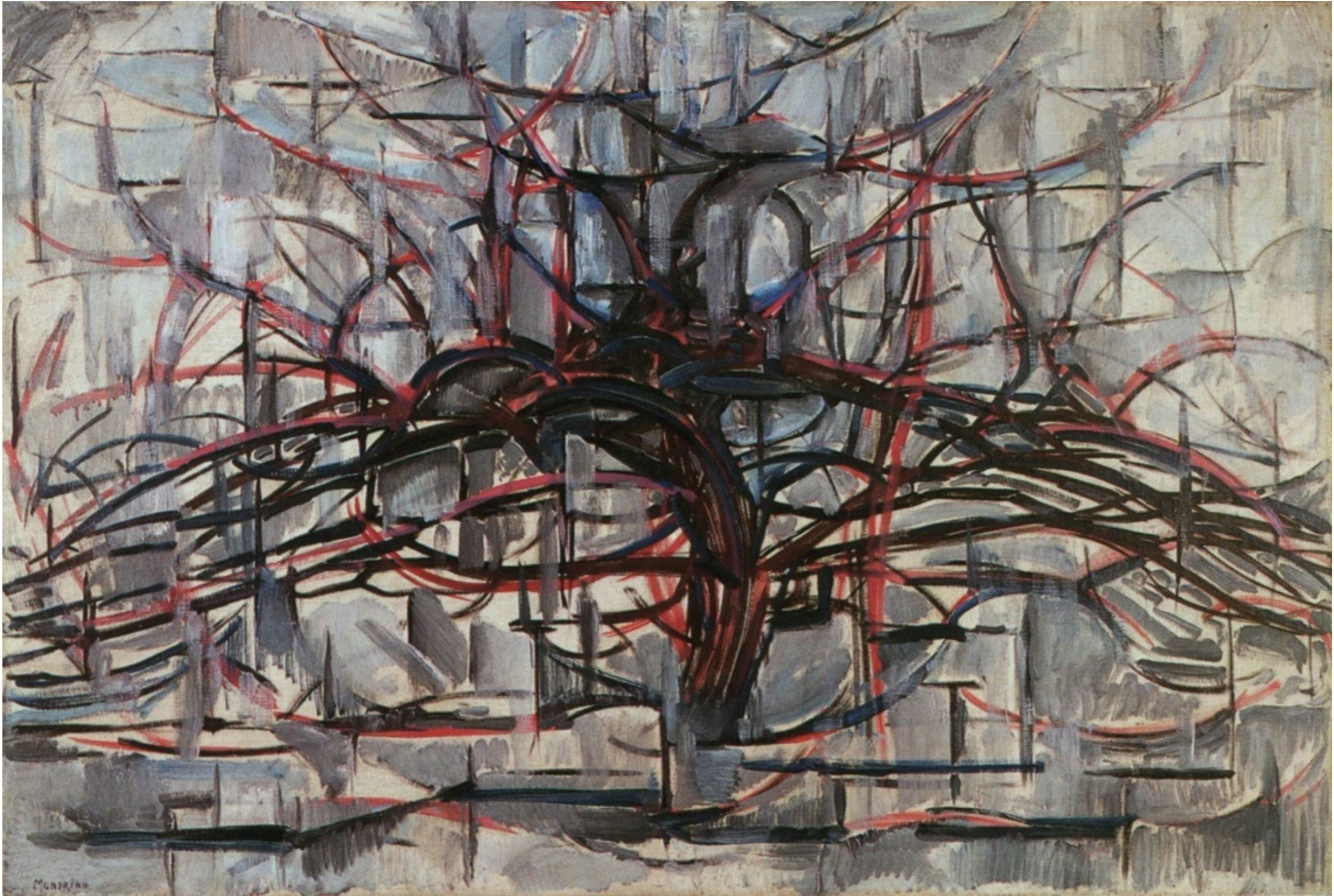

Shower Ordering

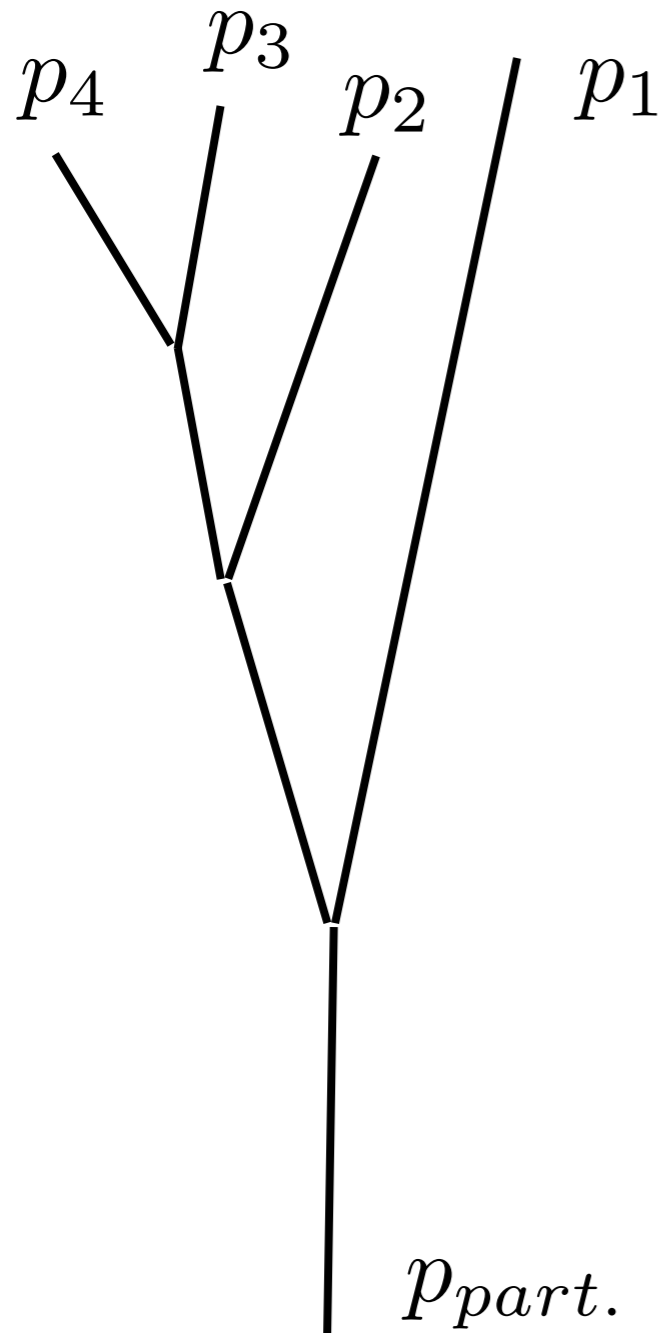

For example: PT ordered Shower
Pcle is showered,
by subsequent emissions with lower
pt mtm

$$p_1 > p_2 > p_3 > p_4$$

Ordering

Applying the Kt Algorithm

1st iteration

$$p_1 > p_2 > p_3 > p_4$$

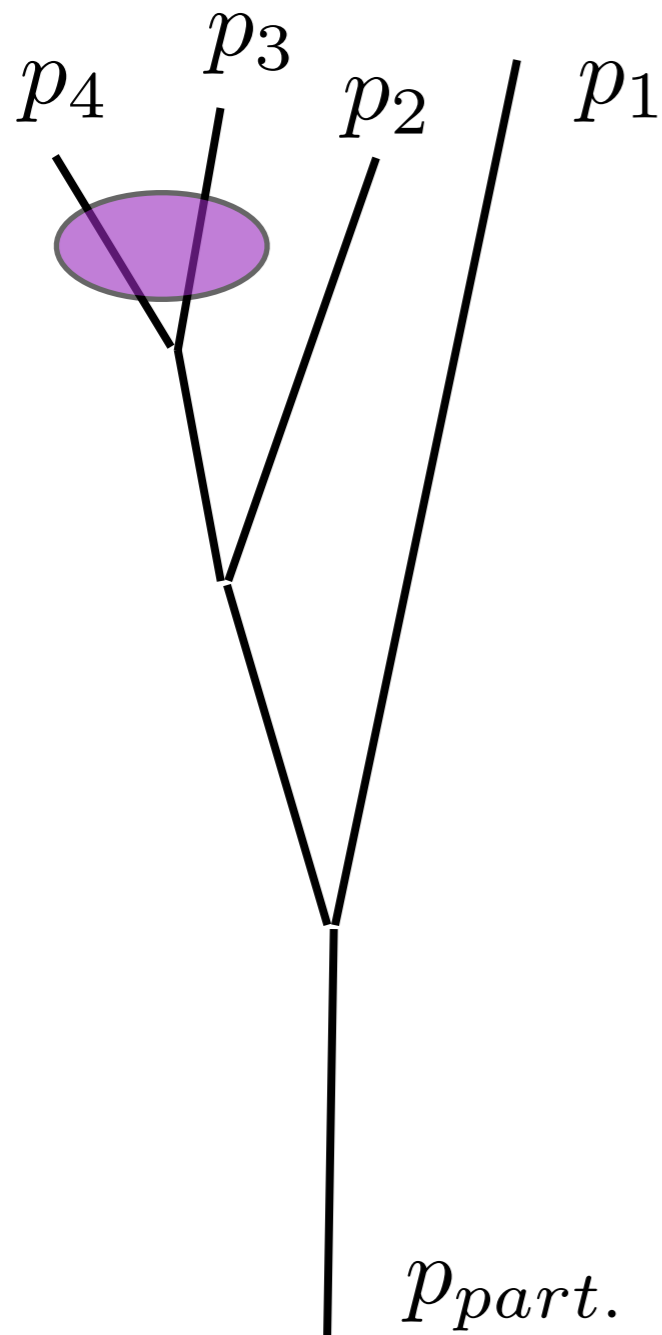

Ordering

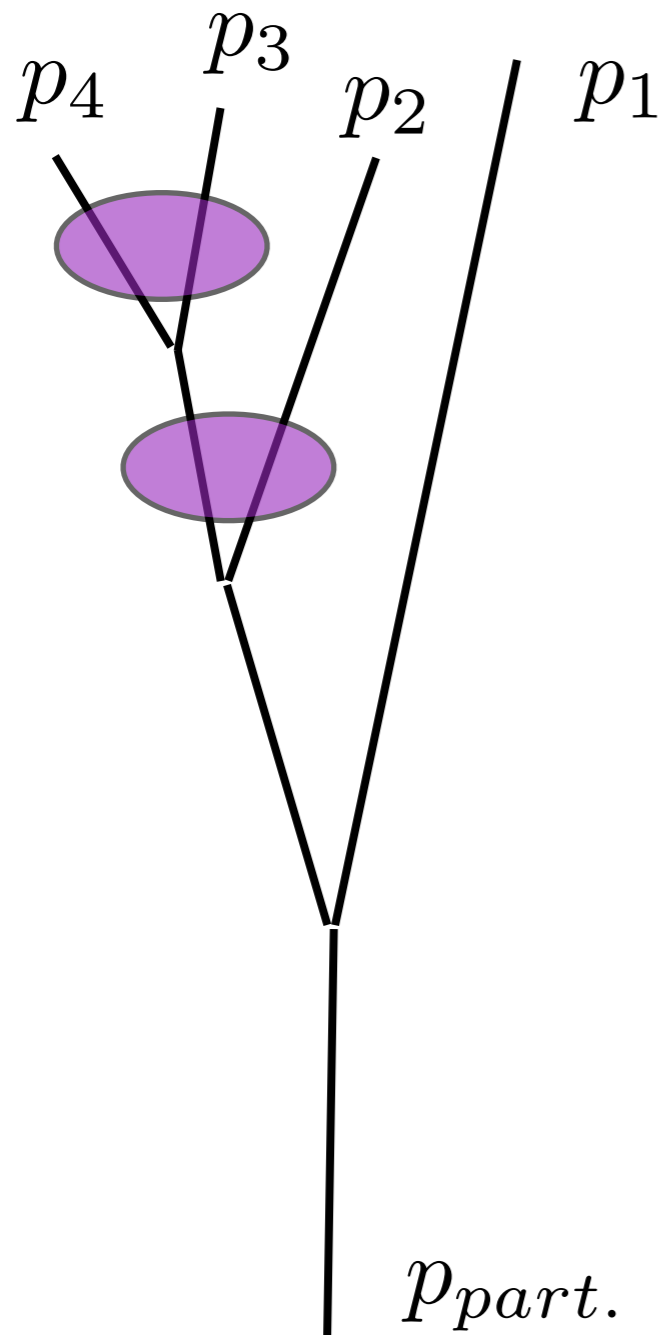

Applying the Kt Algorithm

2nd iteration

$$p_1 > p_2 > p_3 > p_4$$

Ordering

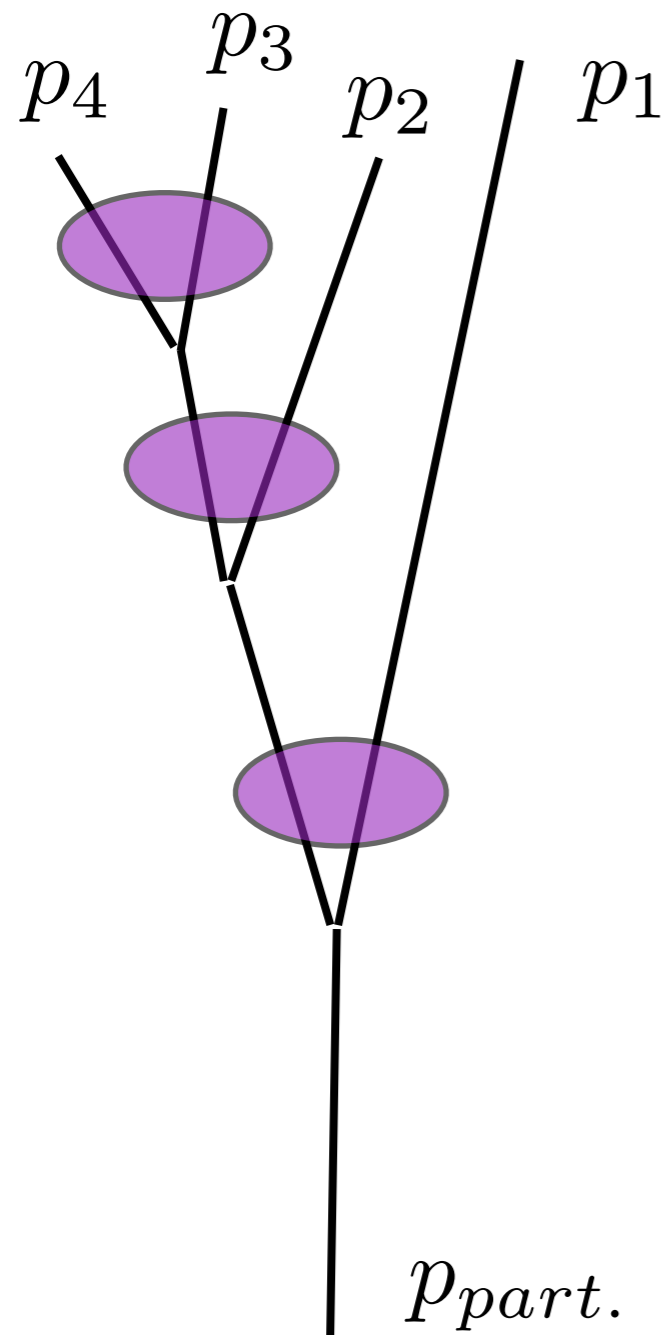

Applying the Kt Algorithm

2nd iteration

$$p_1 > p_2 > p_3 > p_4$$

Ordering

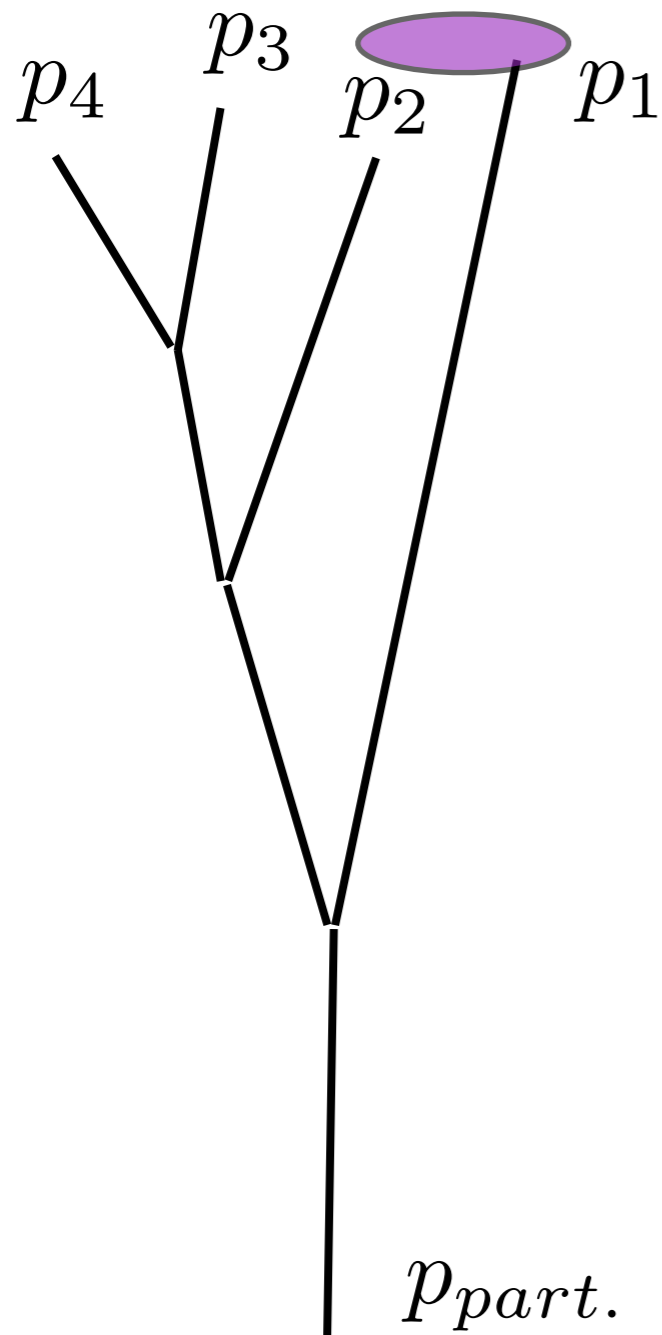

Applying the Anti-Kt Algorithm
ignoring the geo-distance
1st iteration

$$p_1 > p_2 > p_3 > p_4$$

Ordering

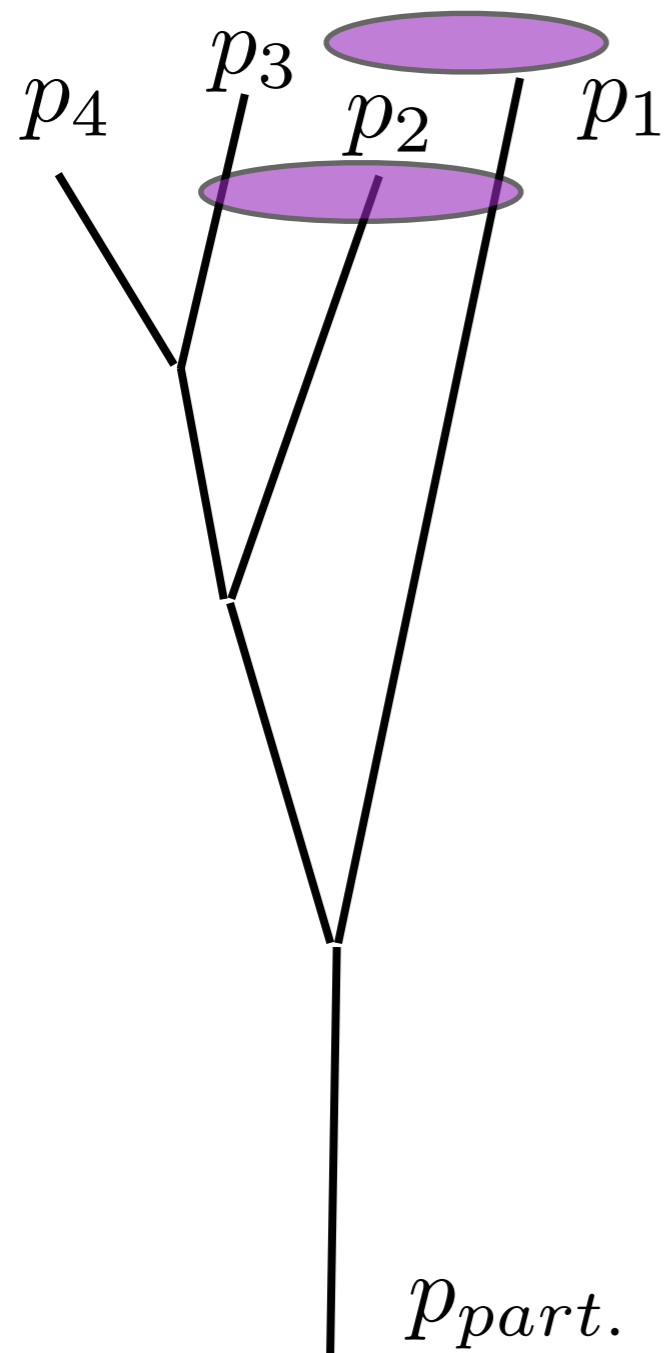

Applying the Anti-Kt Algorithm

2nd iteration

$$p_1 > p_2 > p_3 > p_4$$

Ordering

Applying the Anti-Kt Algorithm

3rd iteration

$$p_1 > p_2 > p_3 > p_4$$

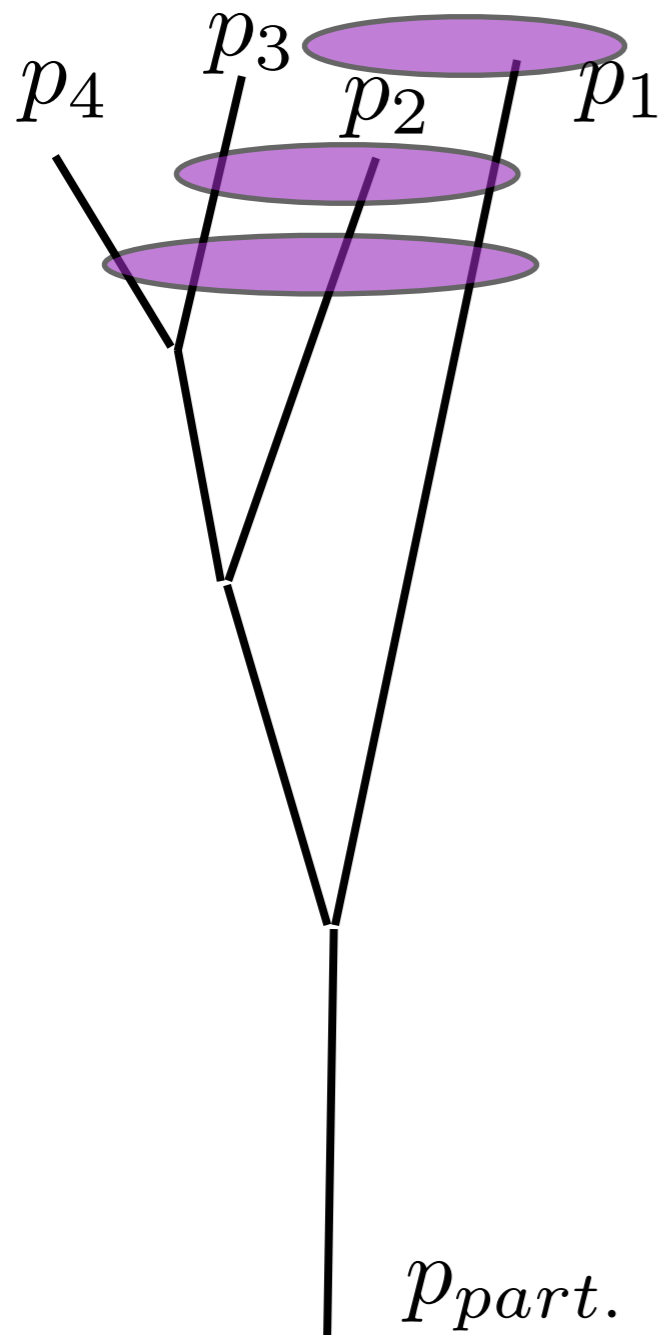

Ordering

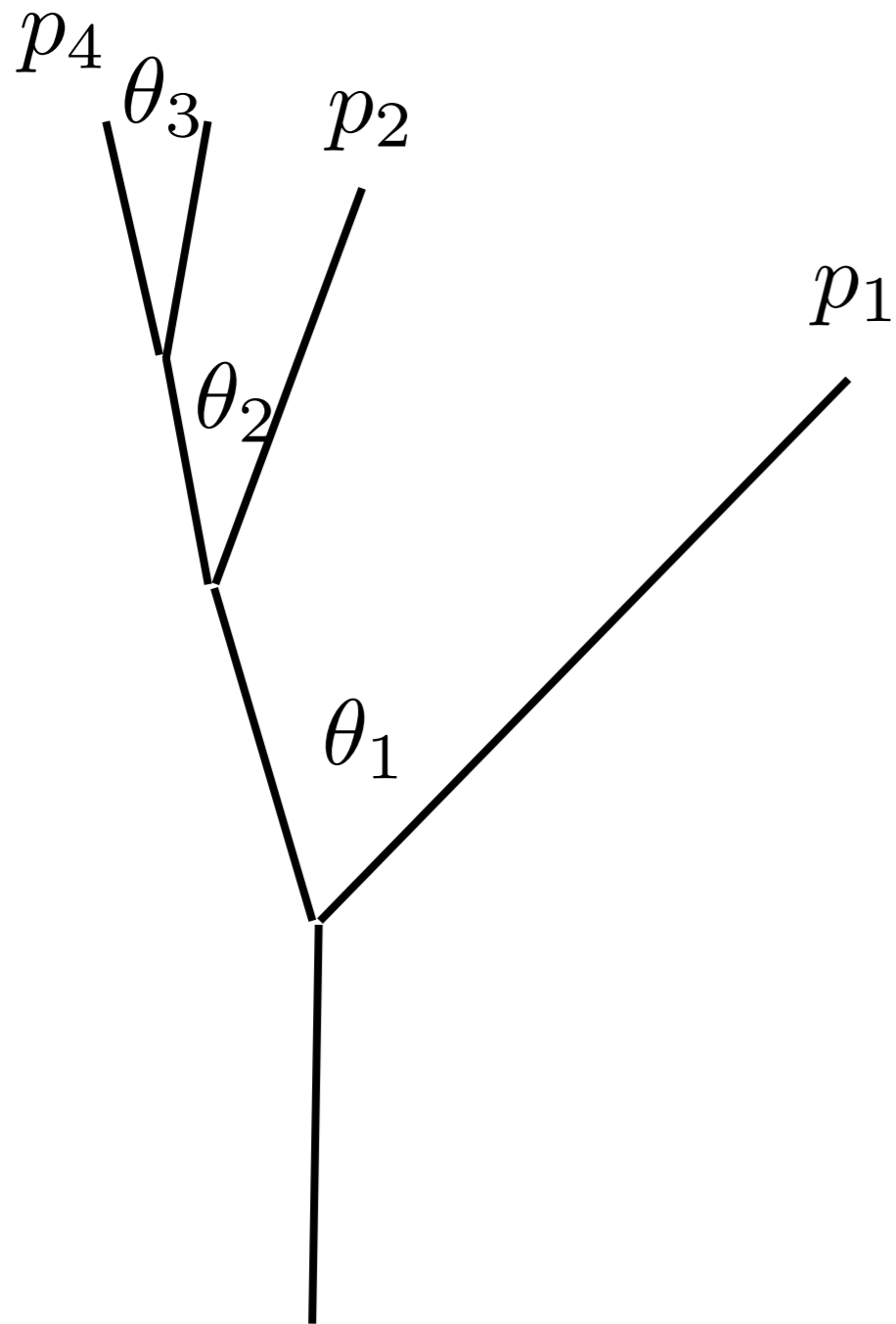

Angle Ordered Shower

$$\theta_1 > \theta_2 > \theta_3$$

Ordering

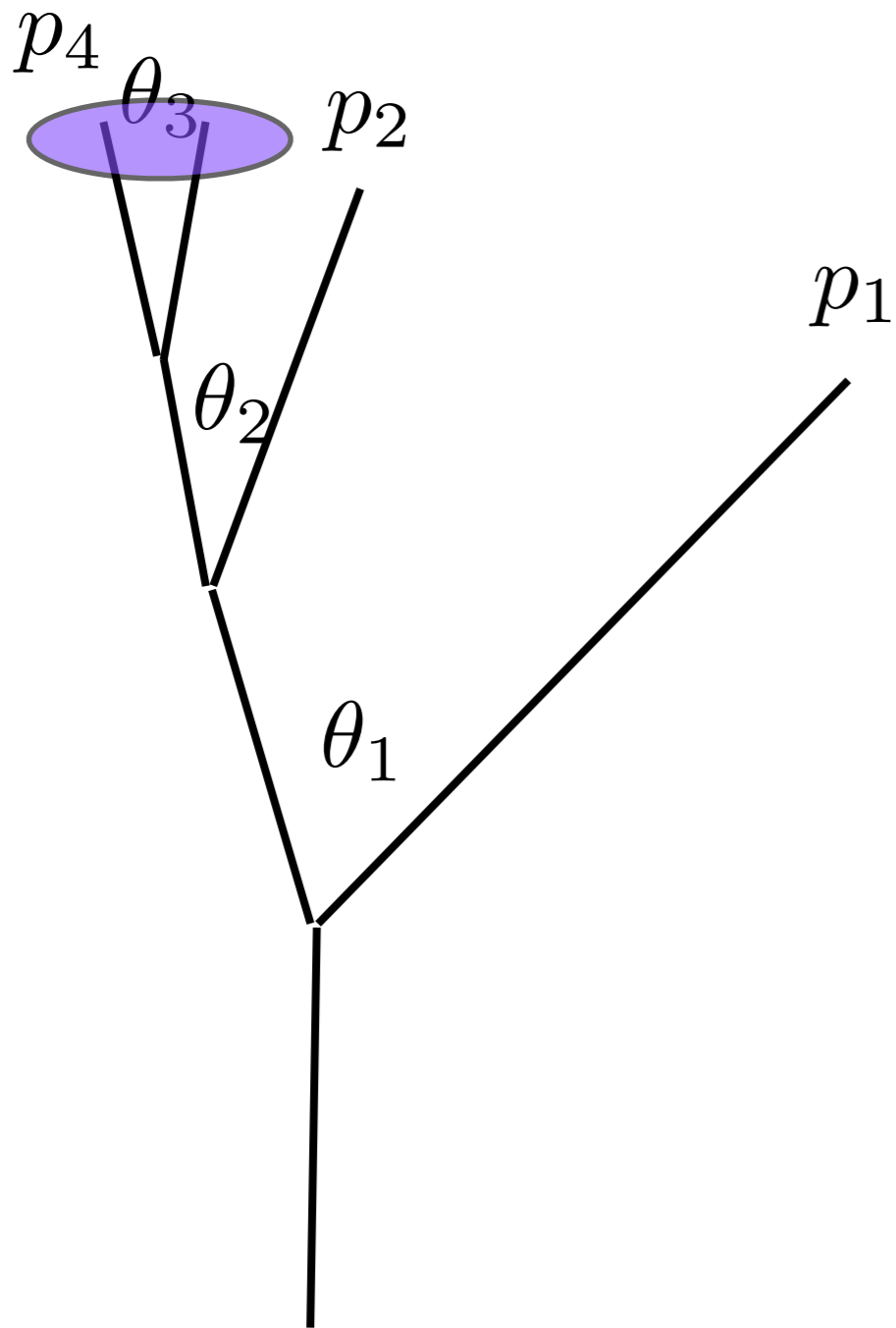

C/A

$$\theta_1 > \theta_2 > \theta_3$$

Ordering

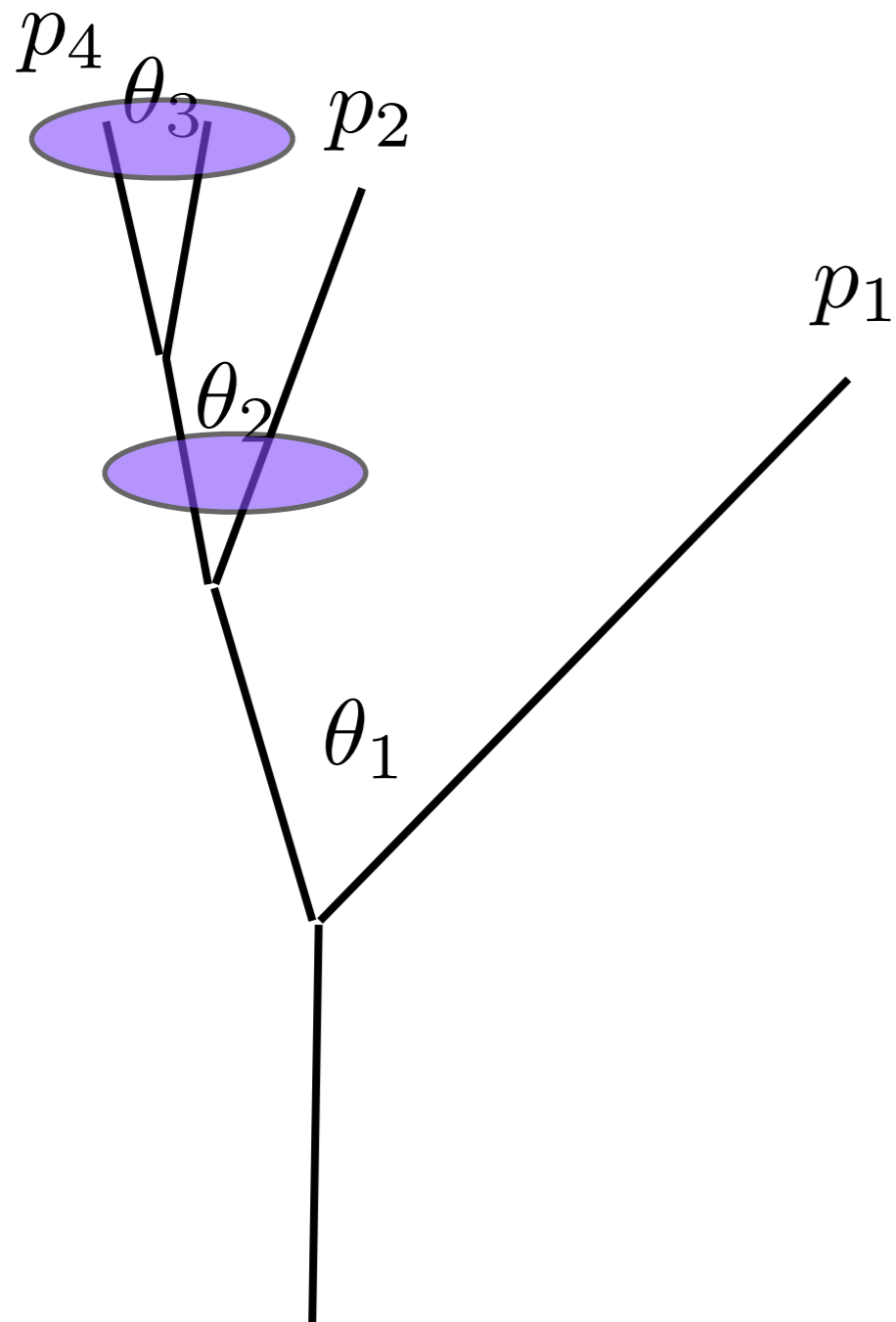

C/A

$$\theta_1 > \theta_2 > \theta_3$$

Branching History

kT & C/A : gives a *possible* shower history

Anti - kT : doesn't give shower history.

However, it builds the jet from the hardest pcle.
Giving the jet an anchor to which it can build
itself

This leads to uniform shape jets!

Jet “Shape”

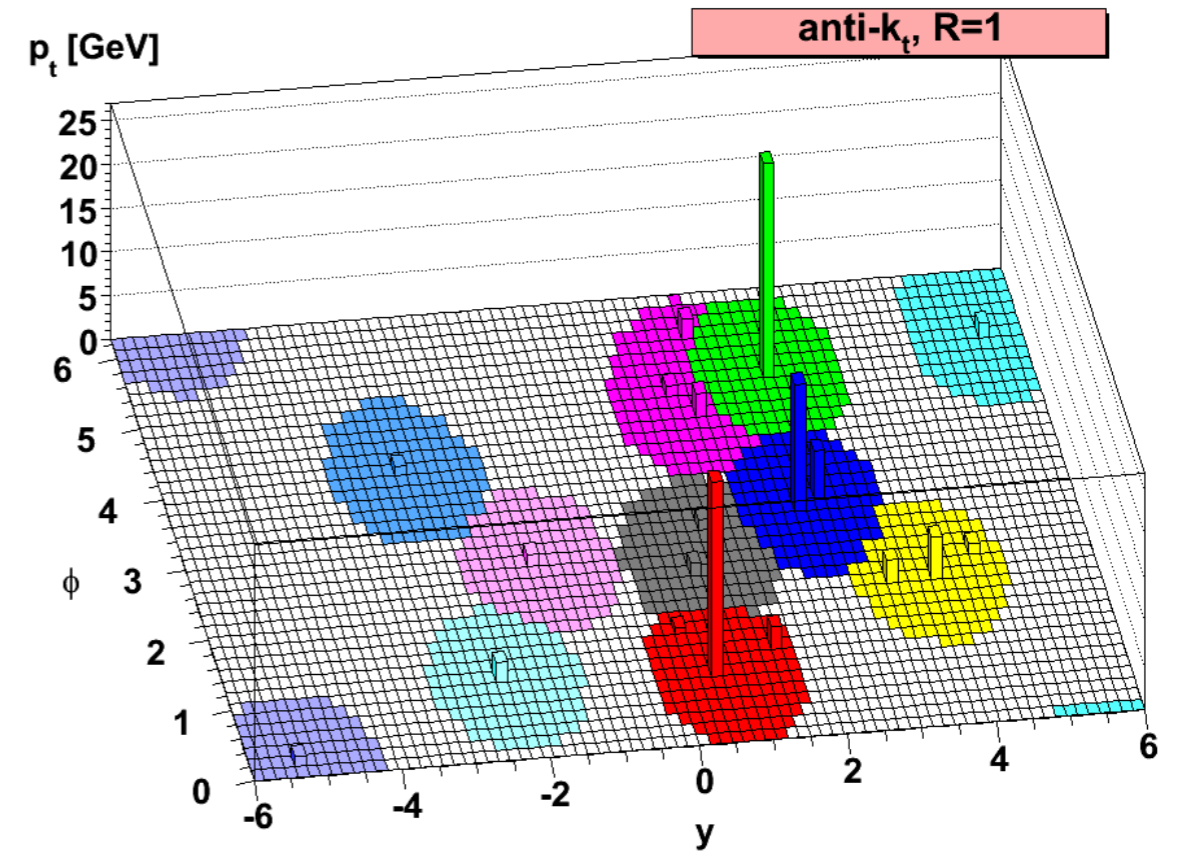
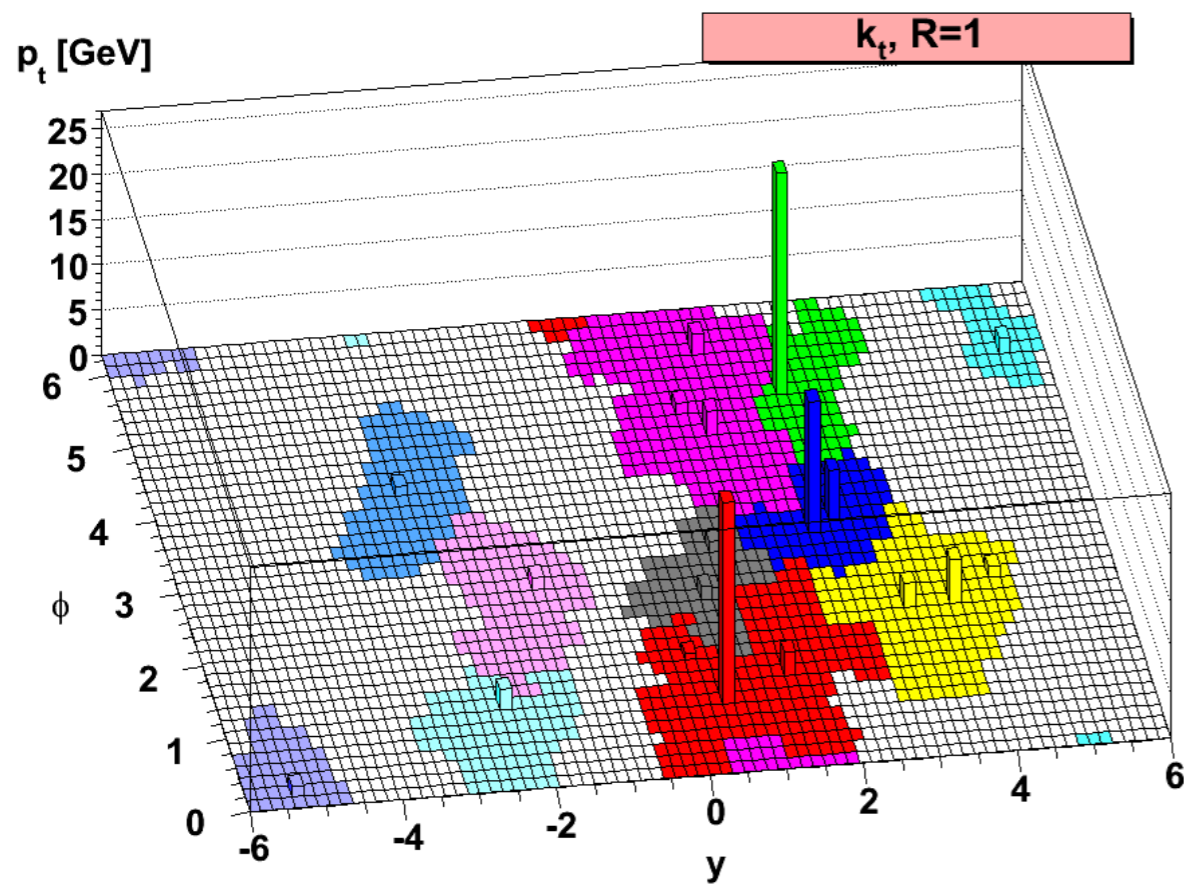

[1] M. Cacciari, G. P. Salam, and G. Soyez, arXiv 0802.1189v2

Experimentally this is particularly relevant when trying to correct jet's energy, or transverse momentum.

Substructure

Re-analysing the our events using a algorithm that gives a possible branching allows us to further filter the Jet.

Filters like BDRS, Prumming.. etc

Place cuts on these subjets, in order to clean the jet from all the radiation, thus allowing us to get closer scales of the hard interaction:

e.g. mass of particles initiating the jet,
fundamental coupling of some new interaction
in the hard interaction

Jet x-sections

$$\frac{d\sigma_{H_A H_B \rightarrow J_1 X}(R)}{dp_T dm_J d\eta} = \sum_{abc} \int dx_a dx_b \phi_a(x_a) \phi_b(x_b) \frac{d\hat{\sigma}_{ab \rightarrow cX}}{dp_T dm_J d\eta}(x_a, x_b, p_T, \eta, m_J, R)$$

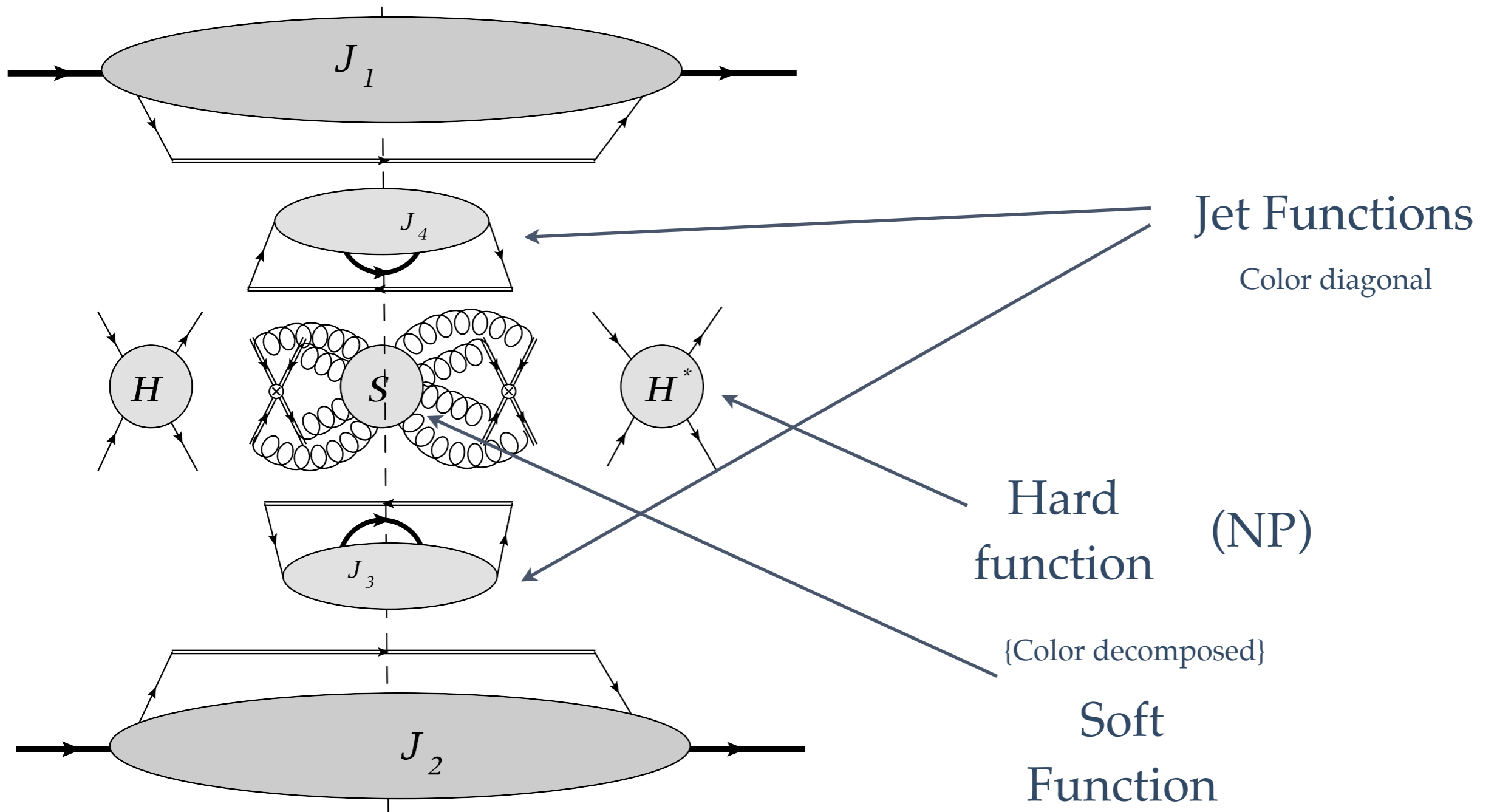

Quarks jets

$$J_i^q(m_J^2, p_{0,J_i}, R) = \frac{(2\pi)^3}{2\sqrt{2} (p_{0,J_i})^2} \frac{\xi_\mu}{N_c} \sum_{N_{J_i}} \text{Tr} \left\{ \gamma^\mu \langle 0 | q(0) \Phi_\xi^{(\bar{q})\dagger}(\infty, 0) | N_{J_i} \rangle \langle N_{J_i} | \Phi_\xi^{(\bar{q})}(\infty, 0) \bar{q}(0) | 0 \rangle \right\} \\ \times \delta(m_J^2 - \tilde{m}_J^2(N_{J_i}, R)) \delta^{(2)}(\hat{n} - \tilde{n}(N_{J_i})) \delta(p_{0,J_i} - \omega(N_{J_c})),$$

Gluons jets

$$J_i^g(m_J^2, p_{0,J_i}, R) = \frac{(2\pi)^3}{2(p_{0,J_i})^3} \sum_{N_{J_i}} \langle 0 | \xi_\sigma F^{\sigma\nu}(0) \Phi_\xi^{(g)\dagger}(0, \infty) | N_{J_i} \rangle \langle N_{J_i} | \Phi_\xi^{(g)}(0, \infty) F_\nu^\rho(0) \xi_\rho | 0 \rangle \\ \times \delta(m_J^2 - \tilde{m}_J^2(N_{J_i}, R)) \delta^{(2)}(\hat{n} - \tilde{n}(N_{J_i})) \delta(p_{0,J_i} - \omega(N_{J_c})).$$

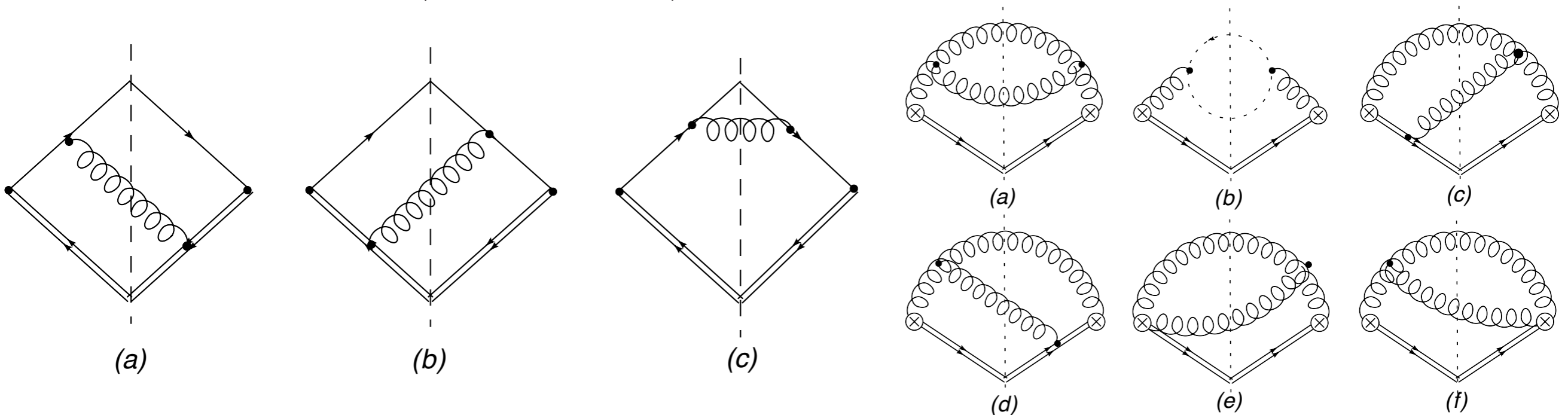

Soft Function

$$S_{IJ}^f = \sum_{N_{J_i}} \langle 0 | w_I^f(0)_{a_i}^\dagger | N \rangle \langle N | w_J^f(0)_{a_i} | 0 \rangle \times \\ \delta(m_J^2 - \tilde{m}_J^2(N_{J_i}, R)) \delta^{(2)}(\hat{n} - \tilde{n}(N_{J_i})) \delta(p_{0,J_i} - w(N_{J_c}))$$

$$w_I^f(x)_{a_i} = \Phi_{\xi_1, \{c_1, d_1\}}^{f_1}(\infty, 0; x) \Phi_{\xi_1, \{c_2, d_2\}}^{f_2}(\infty, 0; x) [\mathbf{C}_I^f]_{d_1, d_2; d_3, d_4} \times \\ \Phi_{\xi_3, \{d_3, c_3\}}^{f_3}(0, -\infty; x) \Phi_{\xi_4, \{d_4, c_4\}}^{f_4}(0, -\infty; x)$$

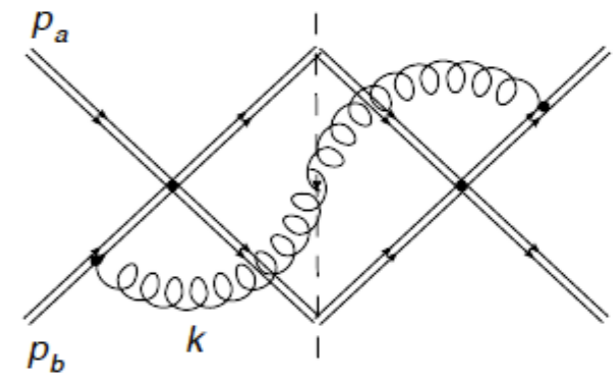
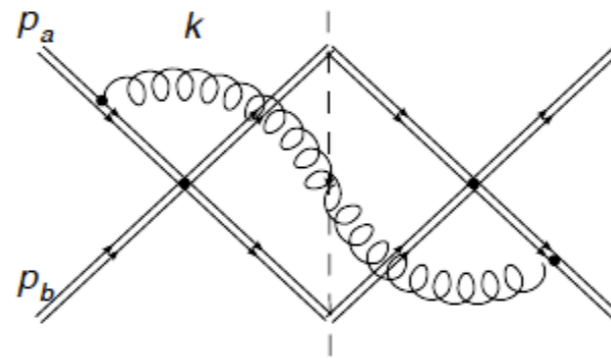

Jet Properties

If the jets are meant as proxies for the partons, how closely are the properties of jets to that of the parent parton.

Jet's Transverse Momentum

We can compute its transverse distribution from the functions above, and fully analytically in the $R \ll 1$ limit

Of particular interest, is how much of partons' p_T goes into our jets of a fixed size R .

Jet's P_T

$$\delta p_T = p_{T,jet} - p_{T,part}$$

$$\delta p_T = \int dz \int \frac{\theta^2}{\theta^2} p_T (\max(z, 1-z) - 1) \frac{\alpha_s}{\pi} P_{qq}(z) \Theta(\theta - R)$$

$$\frac{\delta p_T}{p_T} = \frac{\alpha_s}{\pi} C_i \log R + \mathcal{O}(\alpha_s)$$

$$C_i \rightarrow C_A, C_F$$

Choosing a jet size of $R=0.4$

A “quark” jet has $\sim 5\%$ less transverse $m_{T\text{M}}$ from its parent quark.

A “gluon” jet has $\sim 10\%$ less transverse $m_{T\text{M}}$ from its parent parton.

Gluon Jets tend to be fatter!

Jet Mass Distribution

$$J^{(f)} = 2 \frac{\alpha_S}{\pi} \frac{C_f}{m_J} \log \left(\frac{p_T^2 R^2}{m_J^2} \right)$$

$$S_{IJ}(m_J^2, R^2) \sim \frac{R^2}{m_J^2}$$

$$\frac{d\sigma_{\text{pred}}^c(R)}{dp_T dm_J} = J^c(m_J, p_T, R) \left(\frac{d\sigma^c(R)}{dp_T} \right)$$

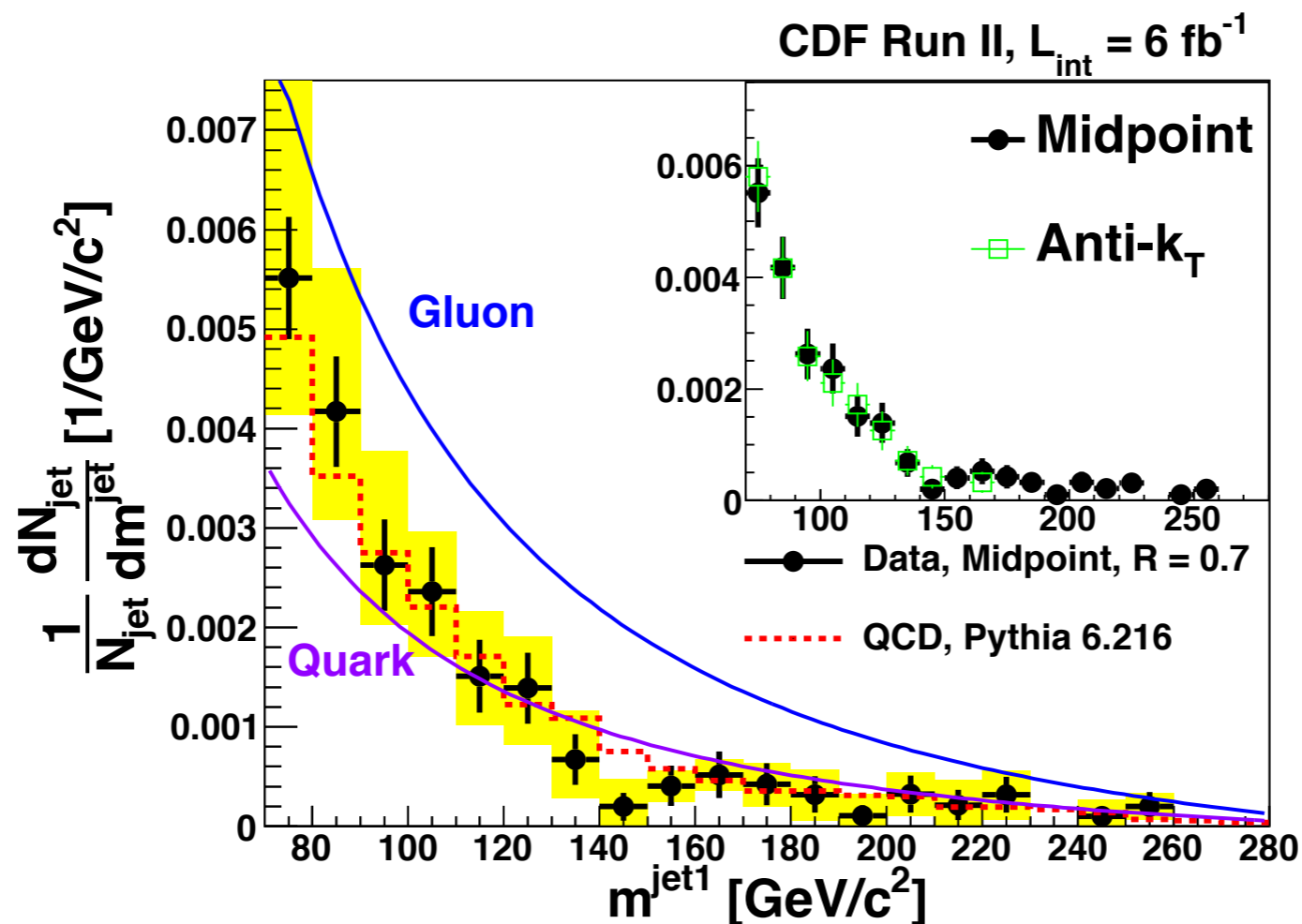

Measured jet mass distributions at CDF for relt.
high Pt

By comparing to jet distribution from analytical
calculations, we can say:

80% of these events can be described by quark jets.

Example: analogy

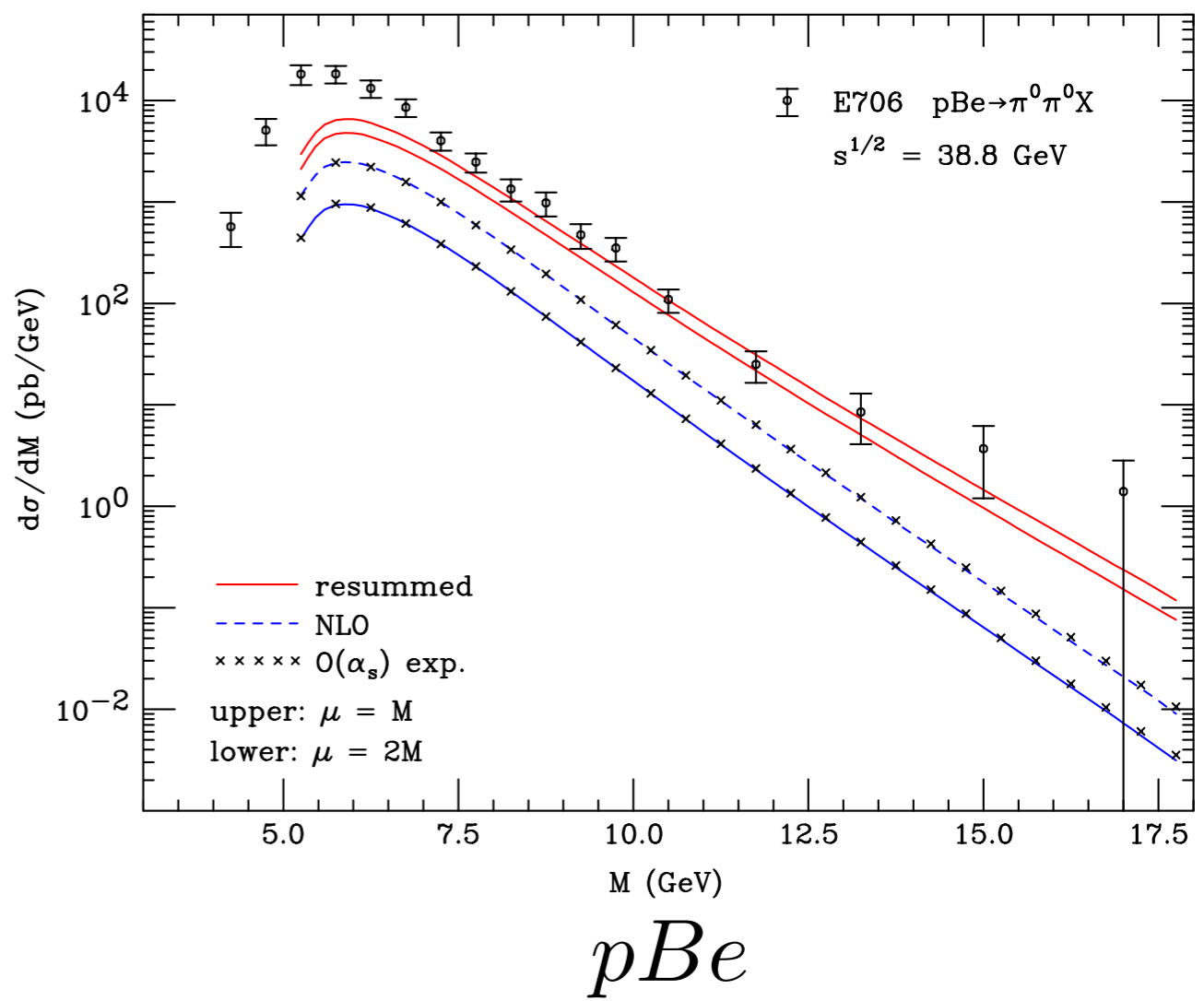
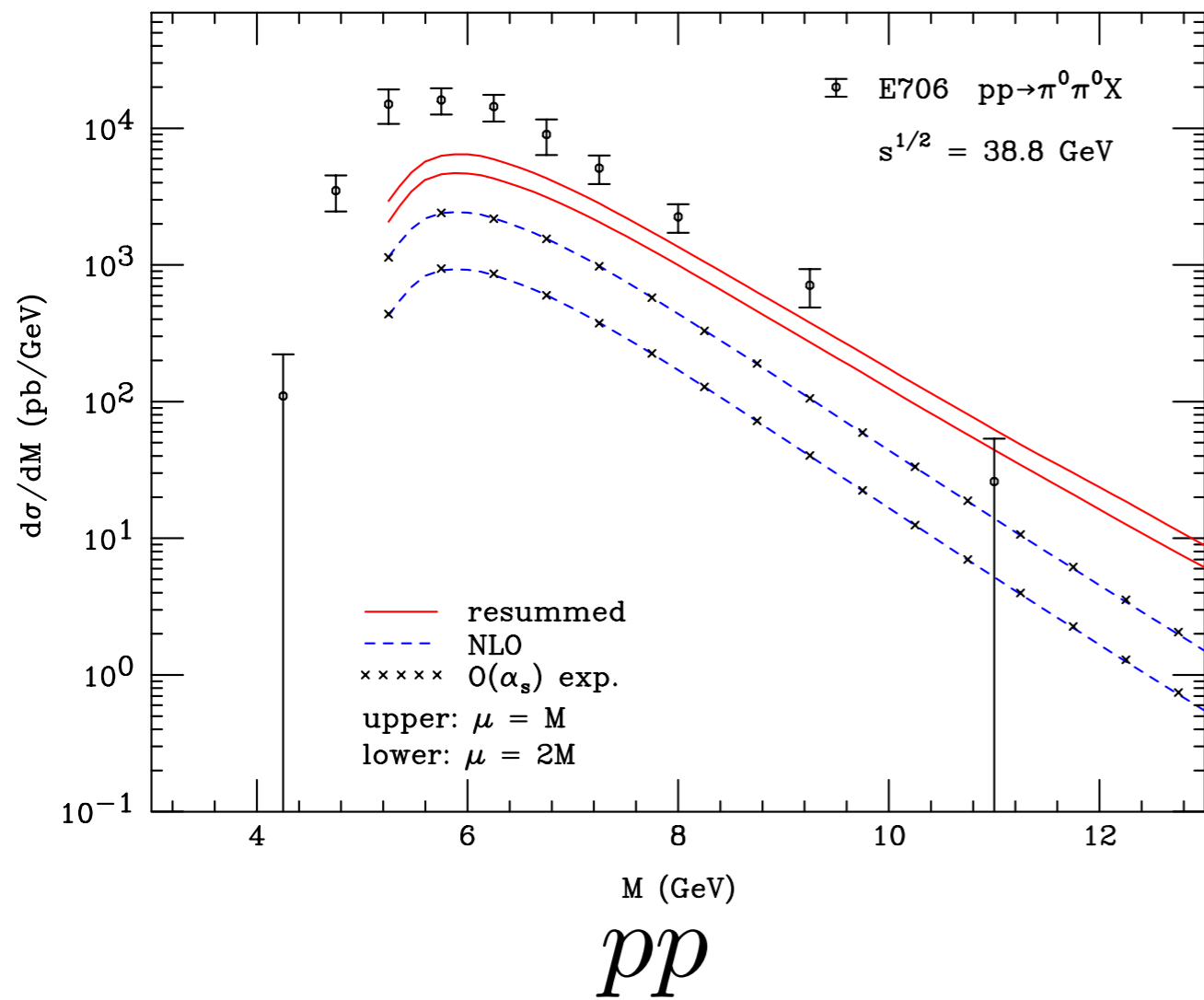

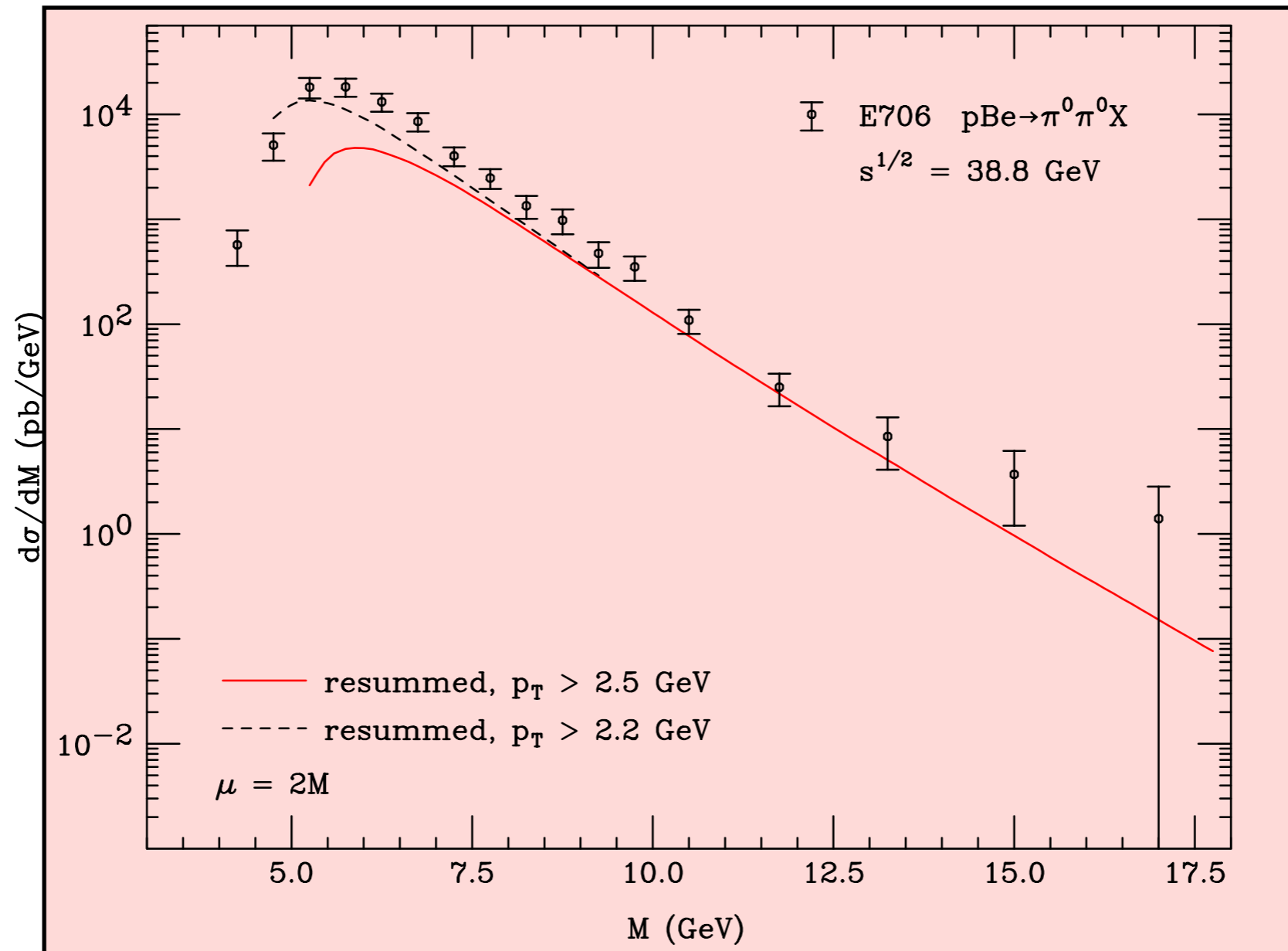

Color Flow in Jets

Jets are at the detector level colorless since, they are made-up by hadrons.

However, if they are supposed to be associated with partons, hard colored objects. Should color information be present ?

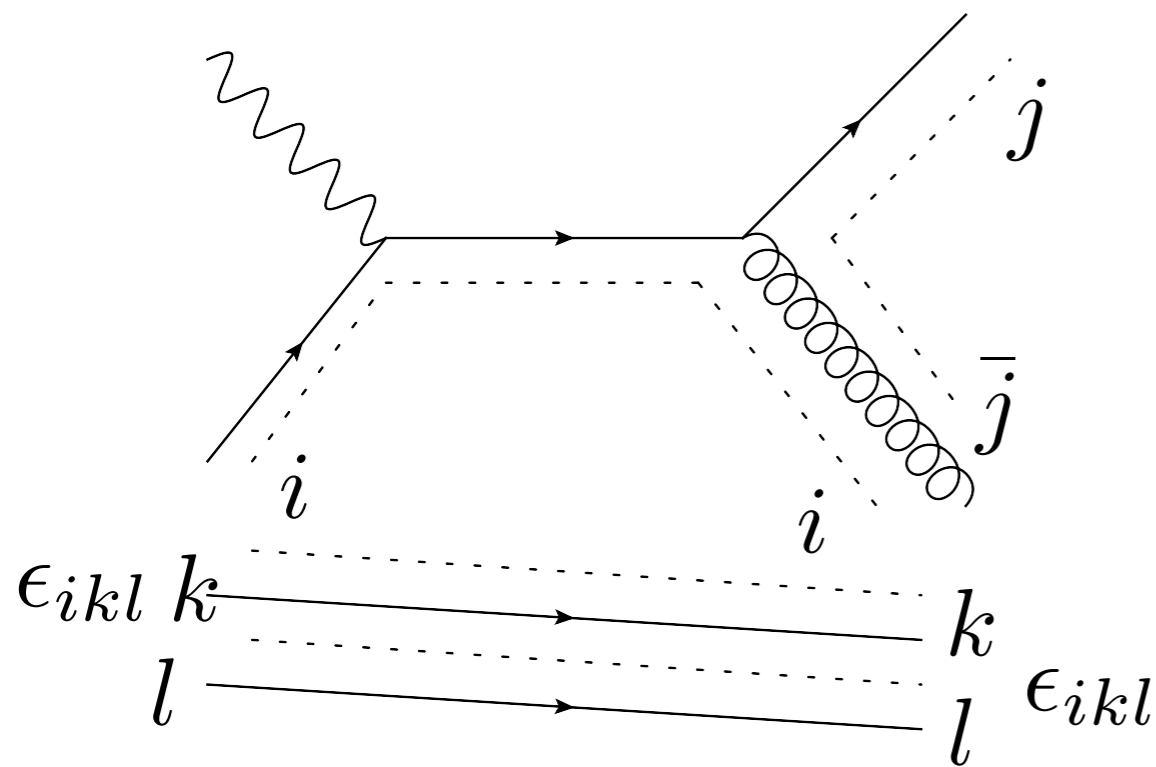

The final states of the hard interaction are color connected, with either the other final states or the remnants of the hadron/nucleus

Radiation outside of the dipole is suppressed

There should be a trail of radiation following the dipoles over the entire event

Because distributions of jet are steeply falling functions,

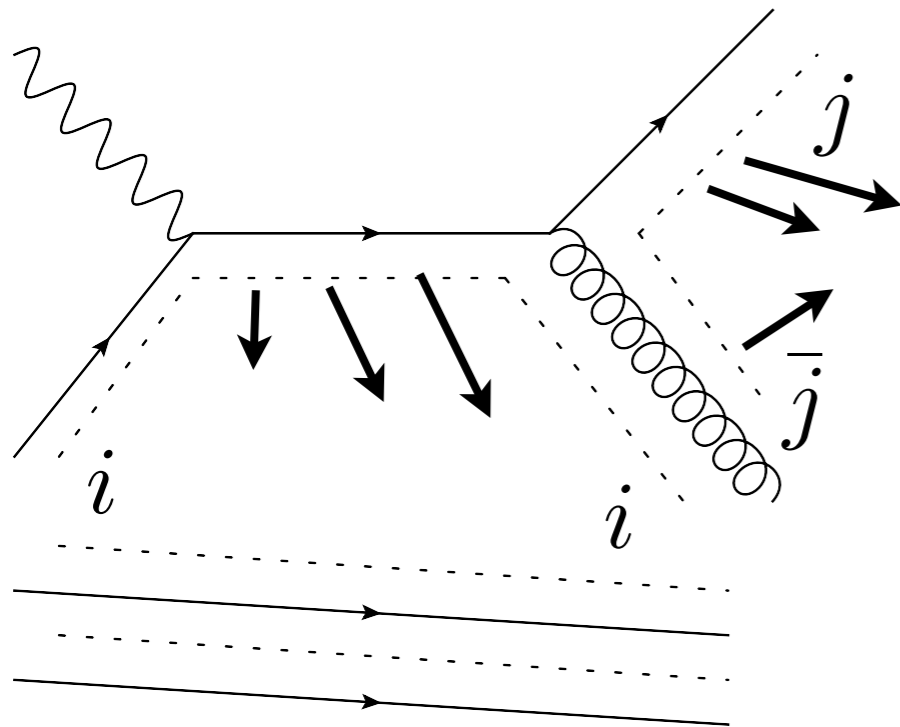

This information would be extremely sensitive to cuts places on the hadrons we observe and the overall background (such as the UE event)

Colour Flow

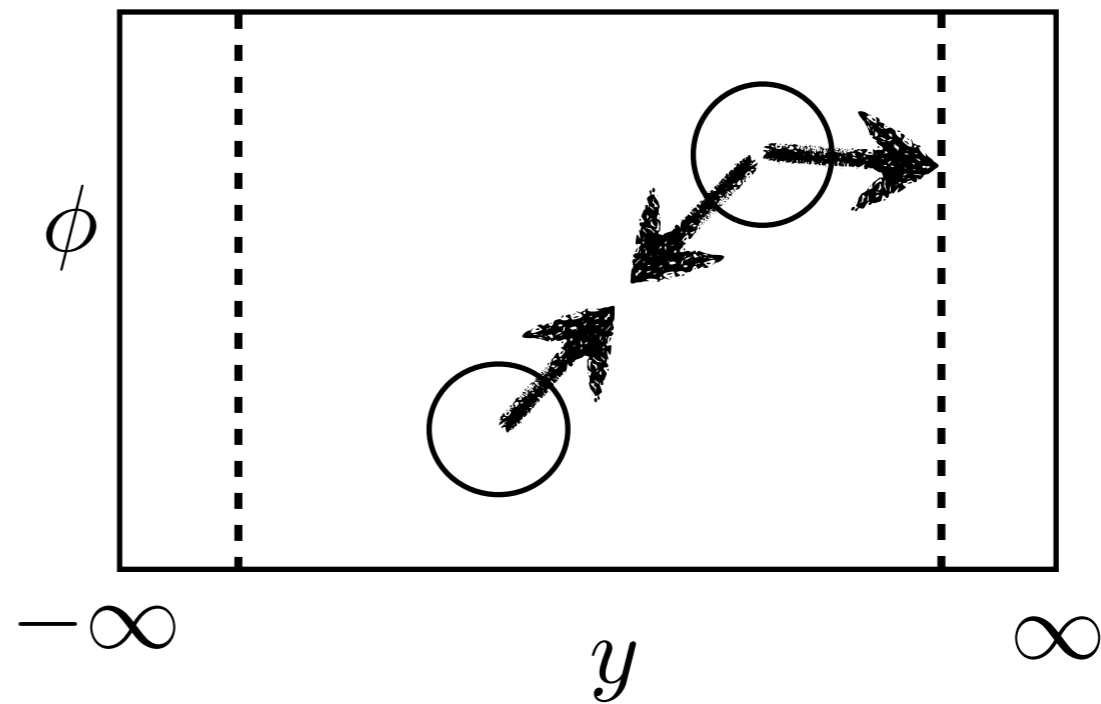
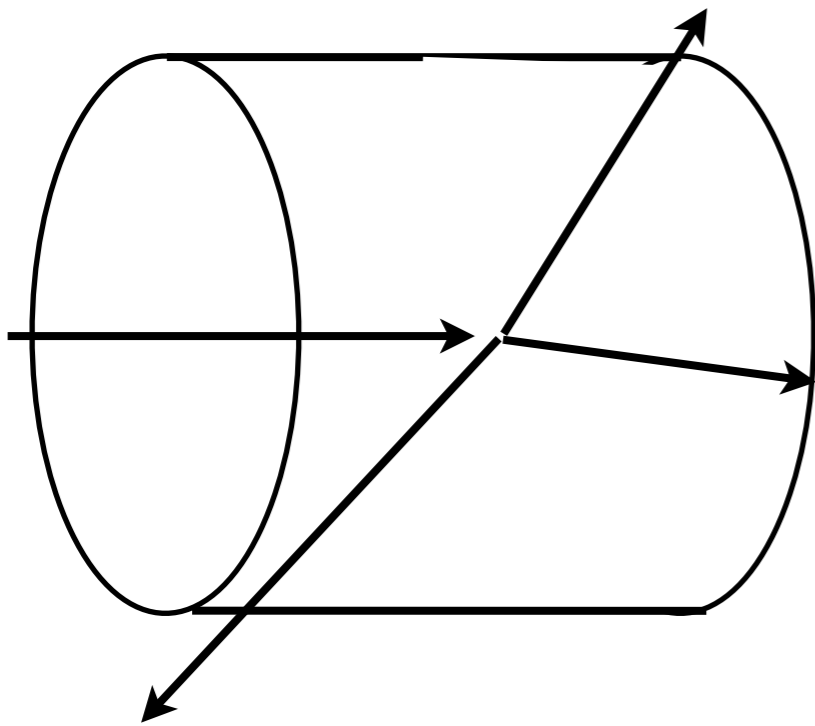

$$f = \frac{E_a(\text{gap})}{E_b(\text{forw.})}$$

Colour Flow

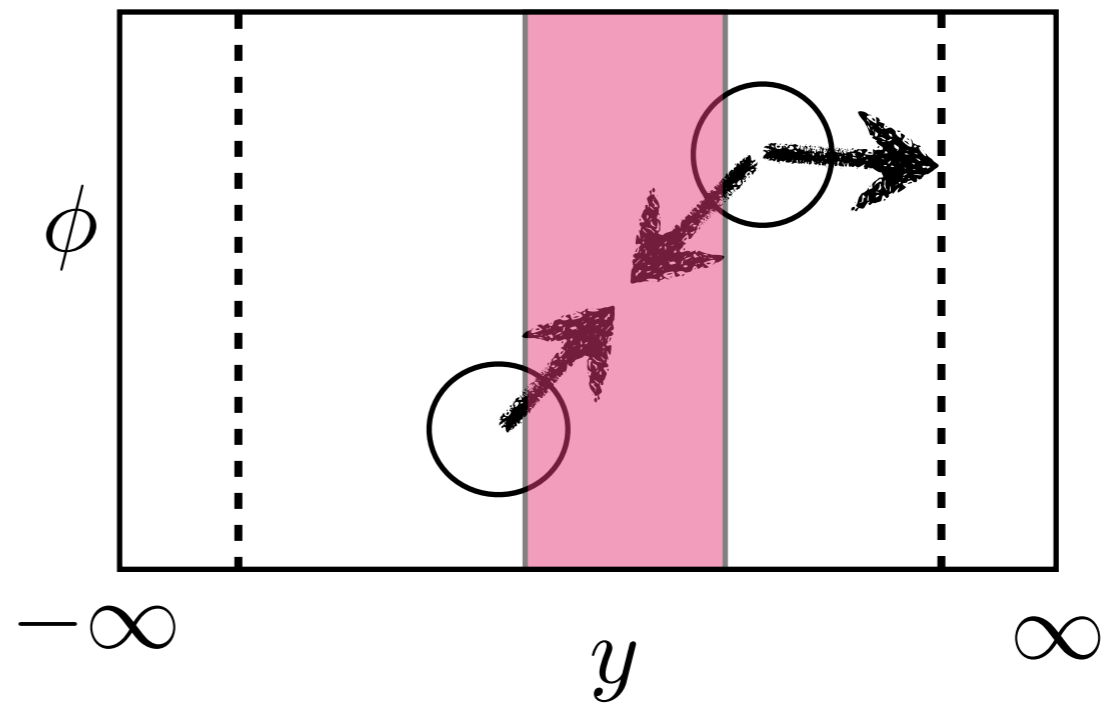
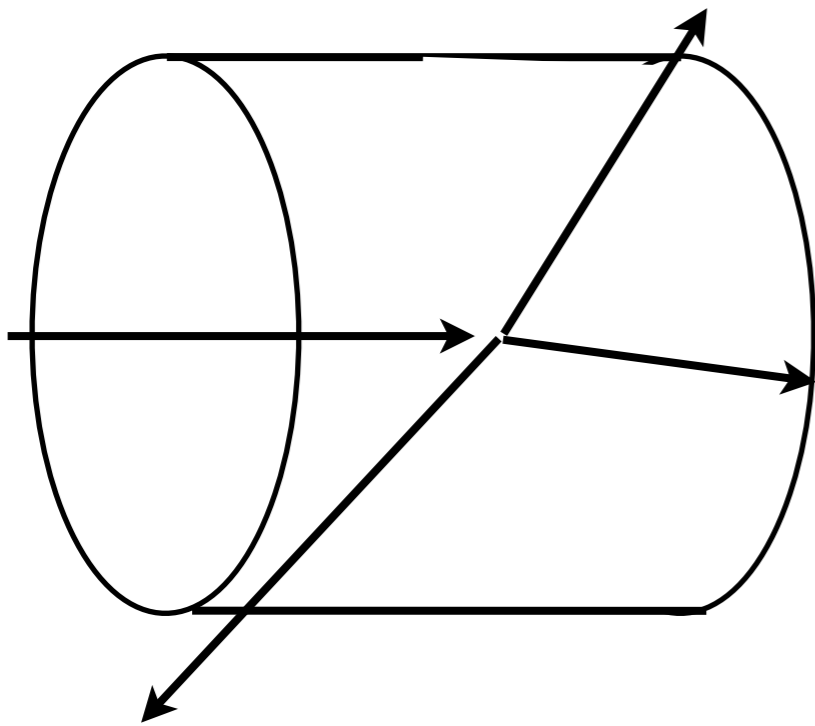

$$f = \frac{E_a(\text{gap})}{E_b(\text{forw.})}$$

Colour Flow

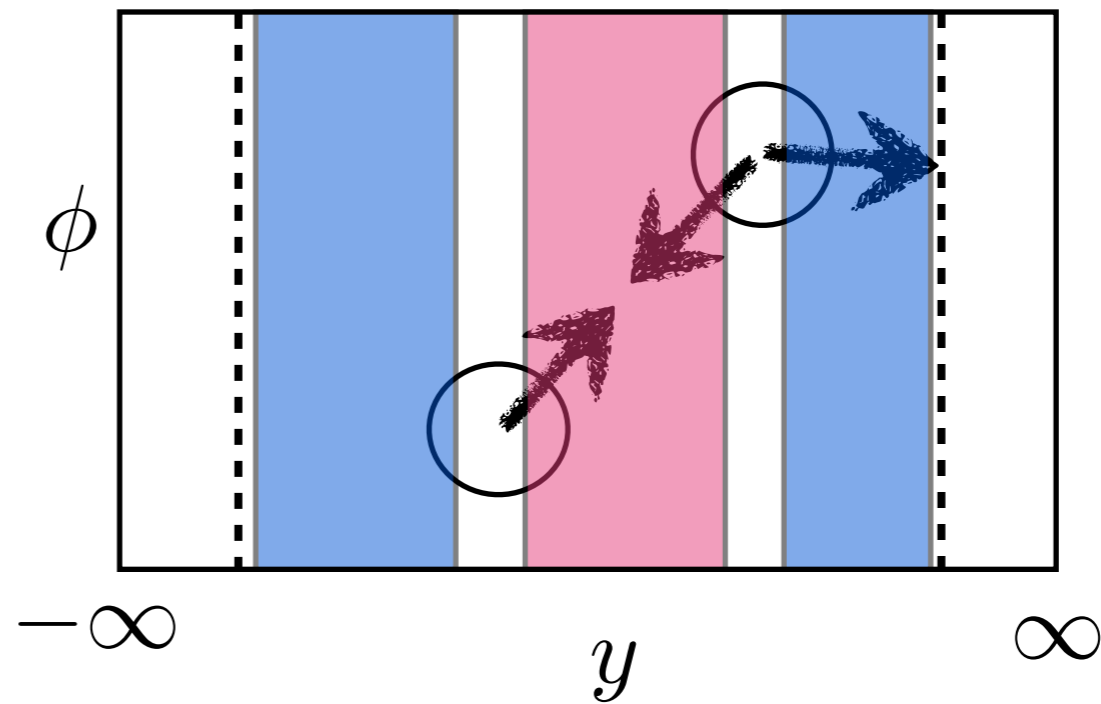
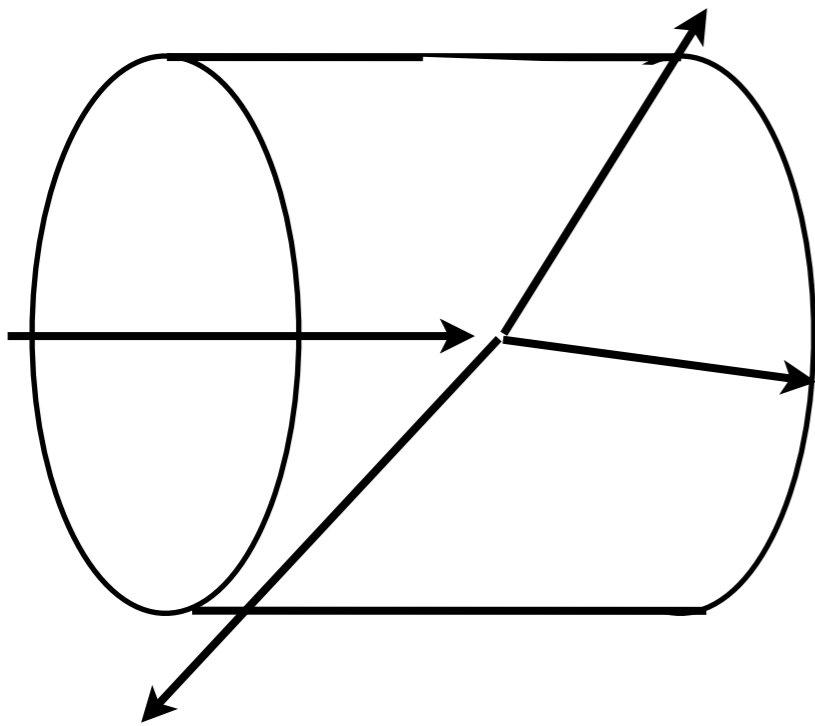

$$f = \frac{E_a(\text{gap})}{E_b(\text{forw.})}$$

Conclusion

While constructing a jet algorithm can be straight-forward, making sure that it is IR safe is not.

LHC detectors have chosen the anti-Kt for its “shape” properties, however it is sometimes useful to re-analyze a Jet substructure by reapplying a kt-Algorithm or a C/A.

Conclusions

Once we have an algorithm we can apply it ,
to the partonic x-section and get meaningful
results for our jets and how it relates to the
microscopic physics in the Hard interaction.

