

Cambridge 1928

Des éléments radioactifs aux
transmutations artificielles

- Effet Compton – radioactivité alpha

Détecteurs et Accélérateurs

Rome 1931

La controverse sur la radioactivité bêta

La controverse sur les rayons cosmiques

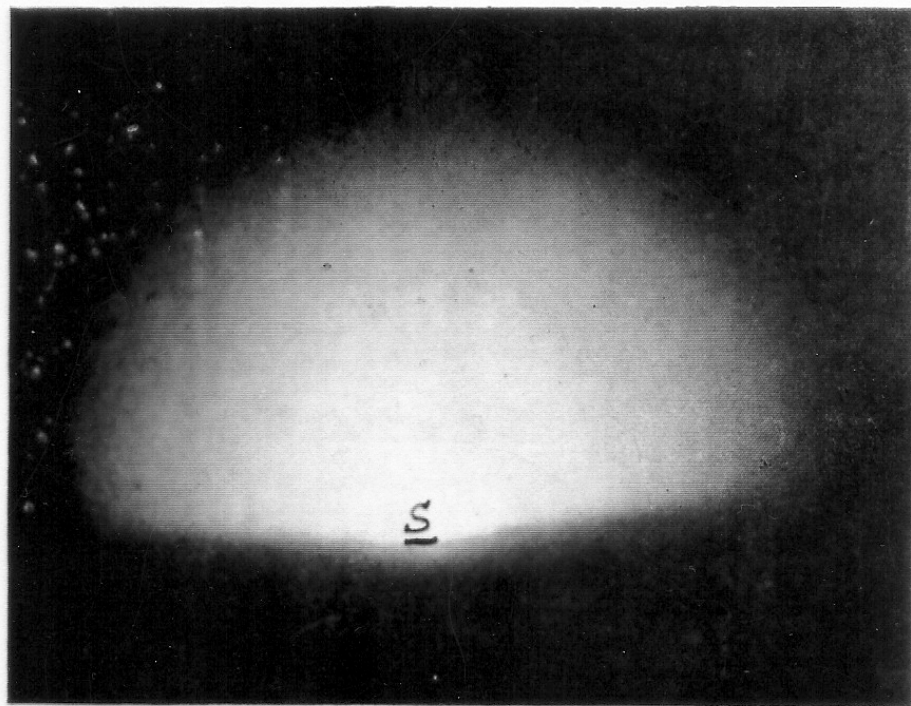
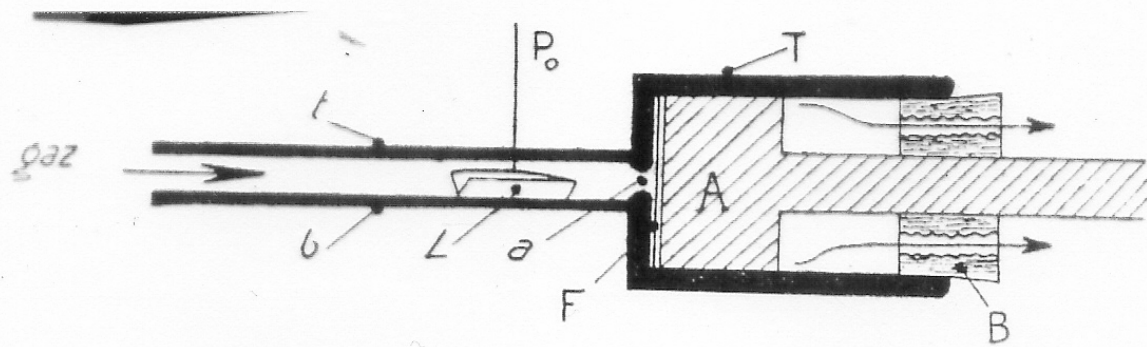

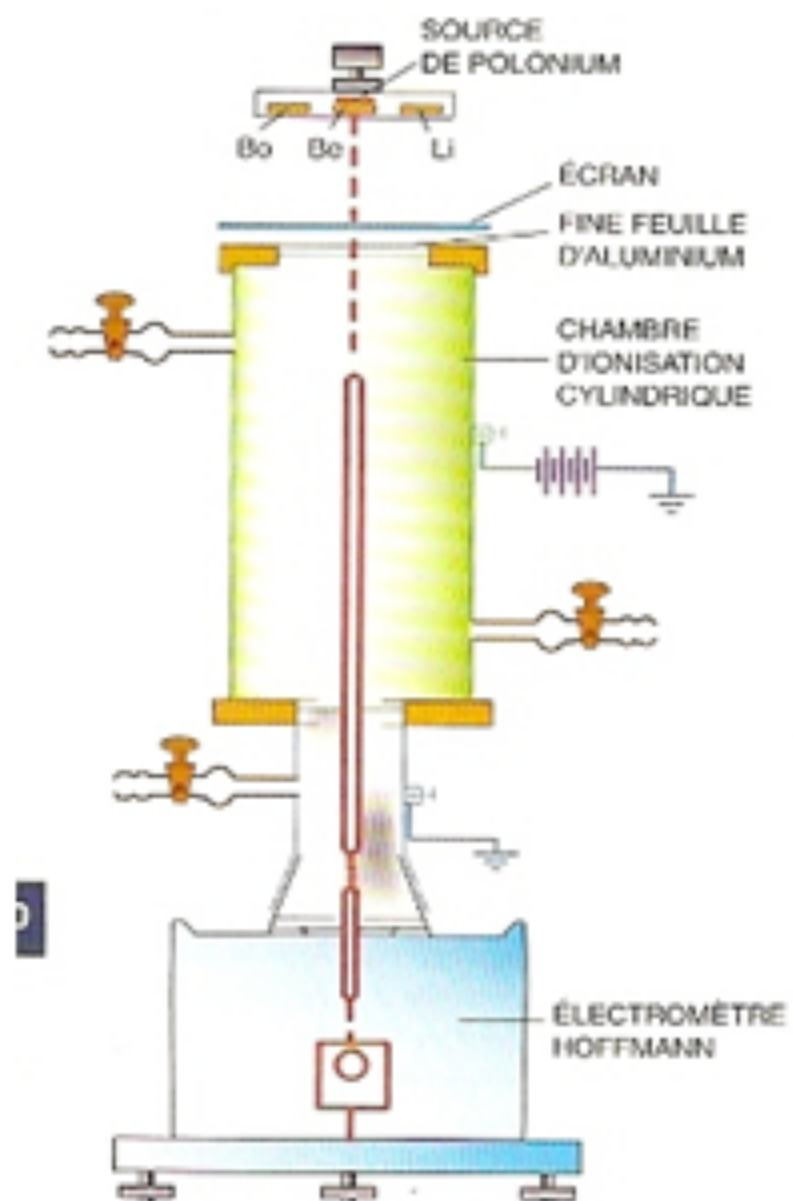
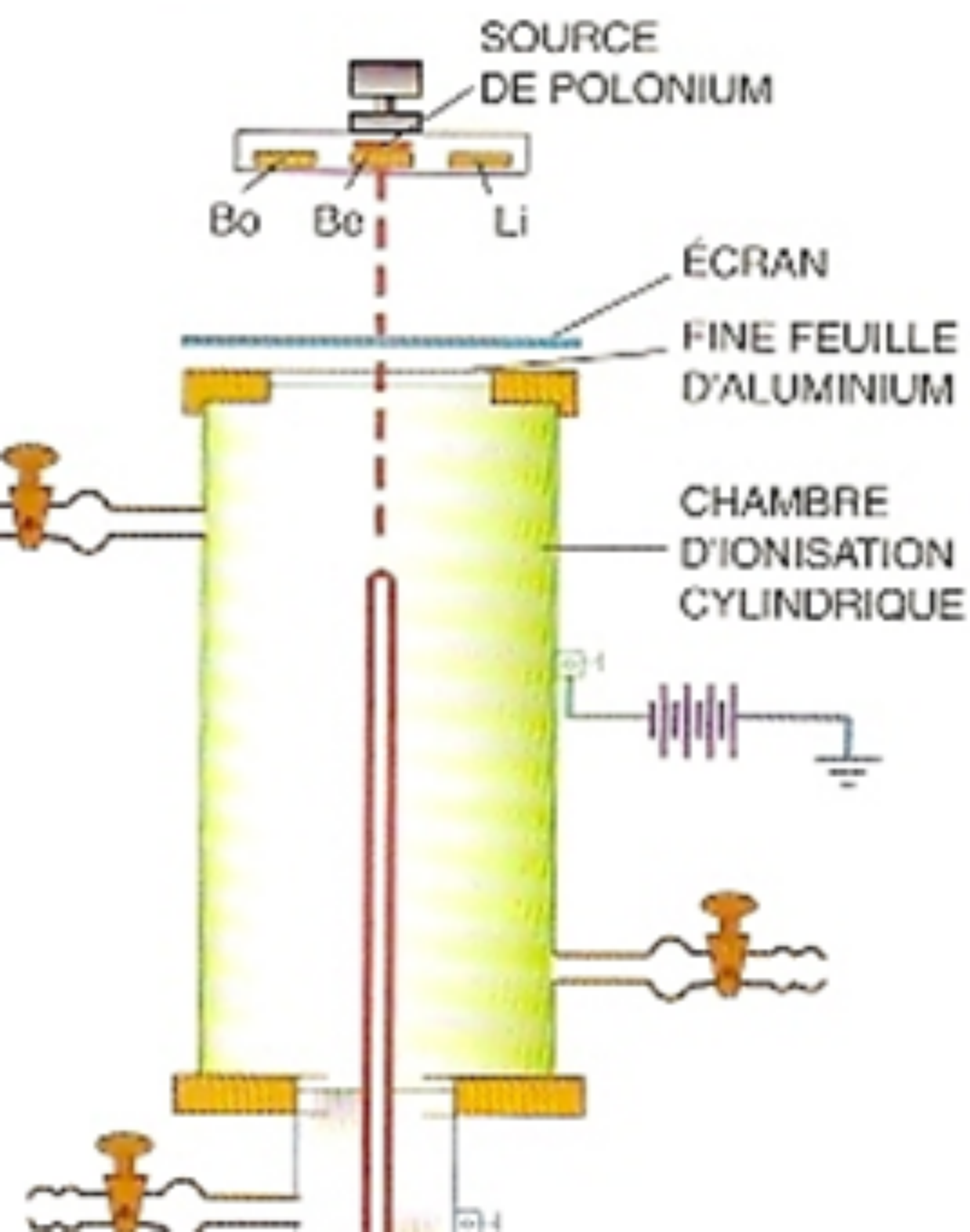

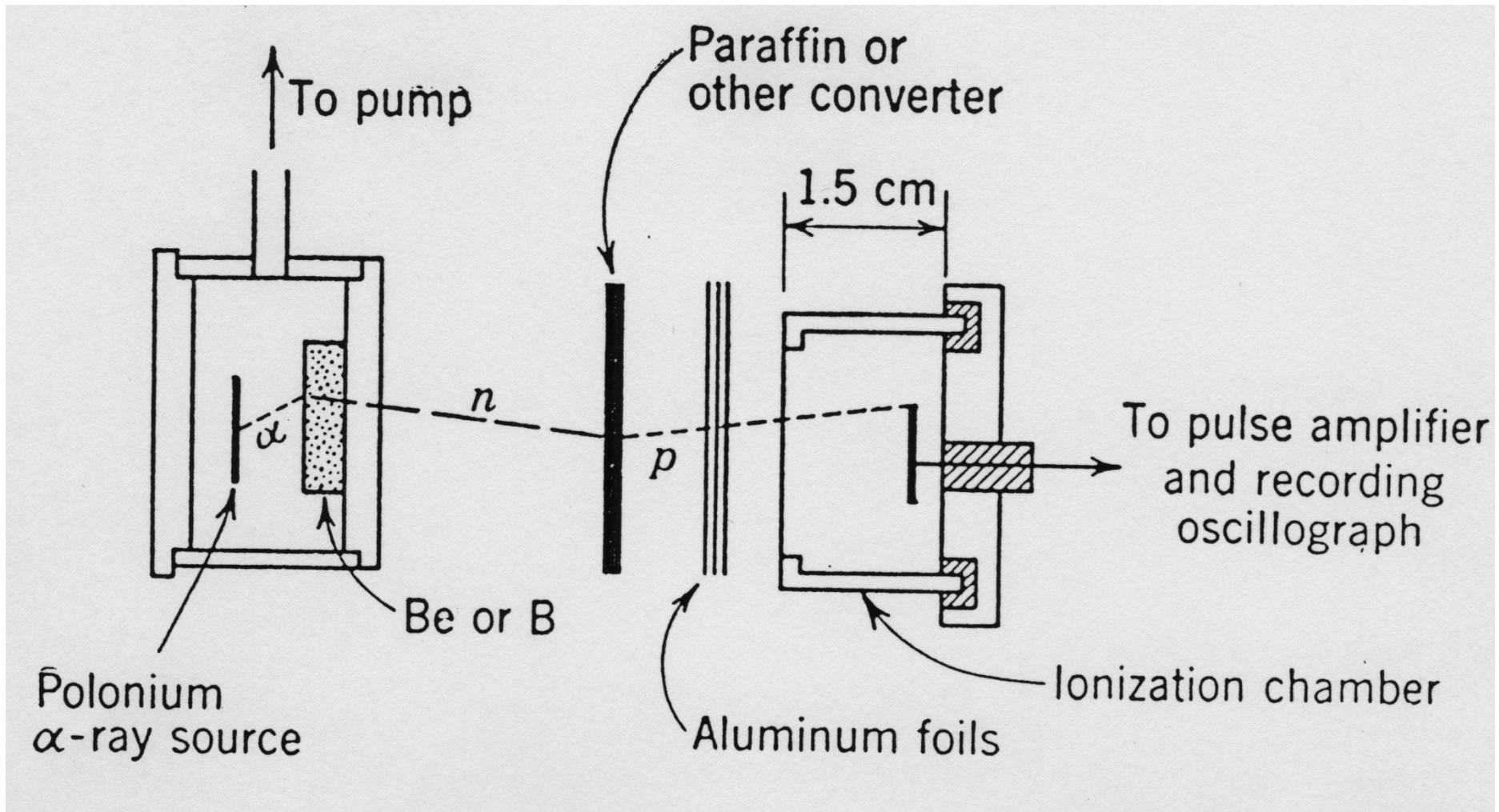

Expérience de Chadwick Fevrier 1932

Anderson été 1932 L'électron positif

Création d'une paire d'électron positif et

d'électron négatif par « matérialisation d'un rayon Gamma

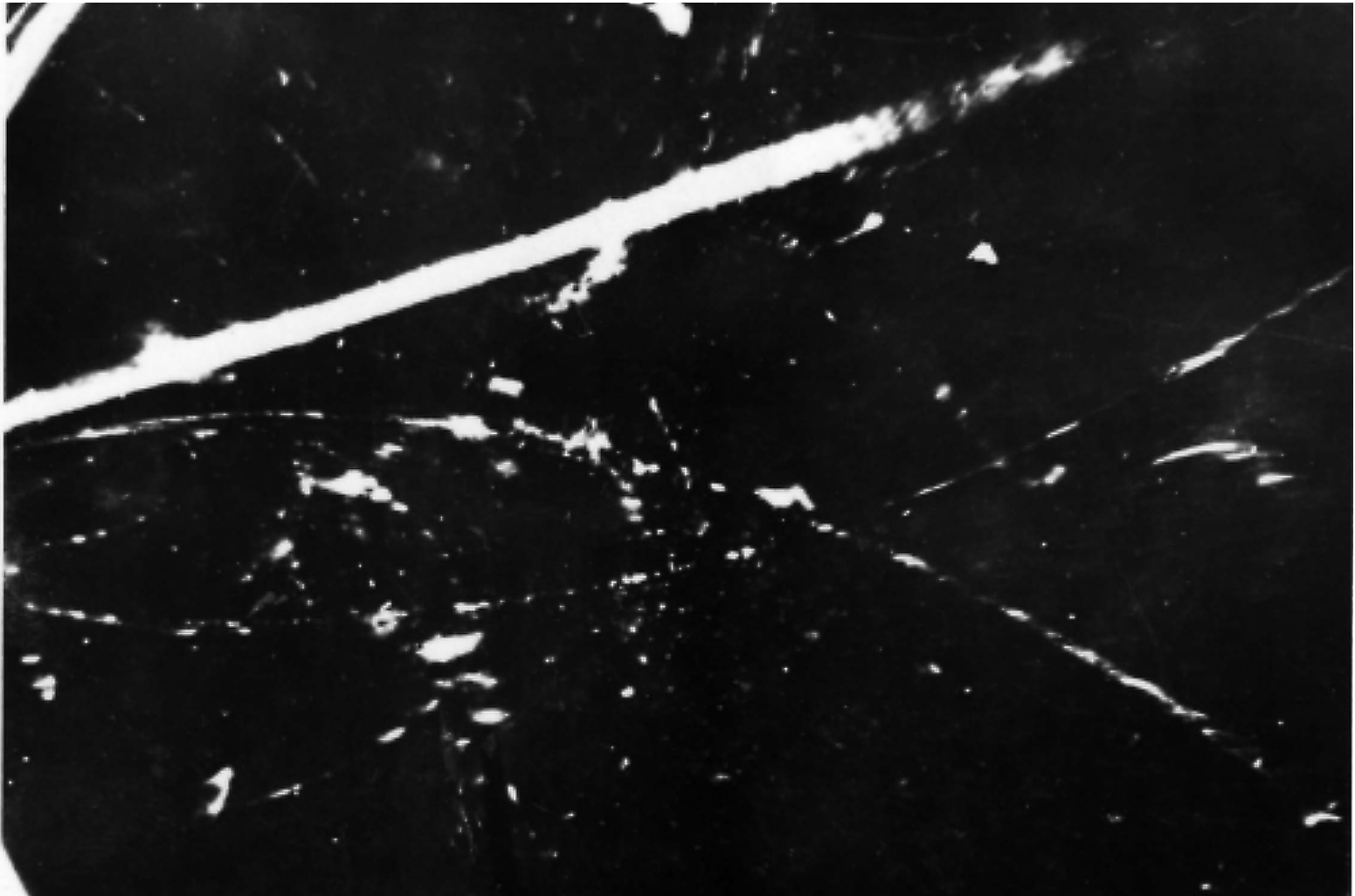



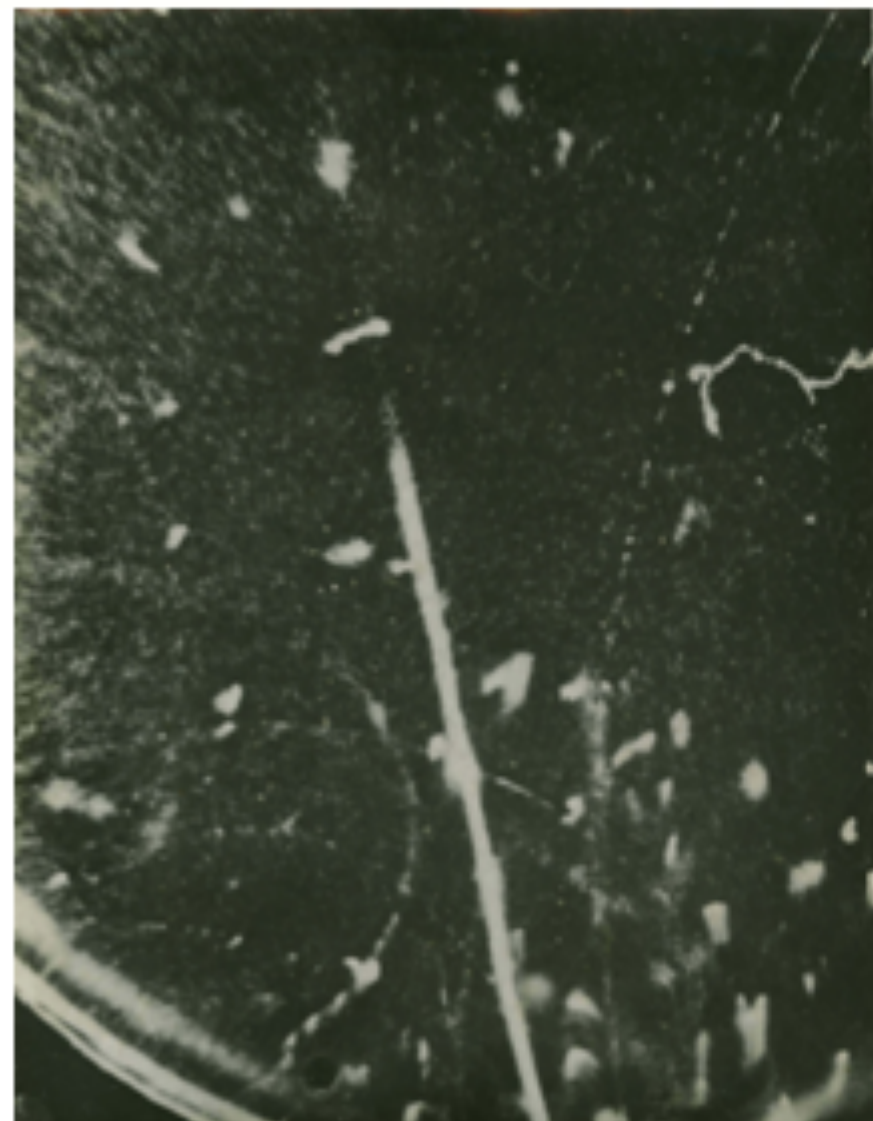

Pa + Al

	+	-
< $0,4 \times 10^6$	2	17
$0,4 \sim 0,6 \times 10^6$	4	14
$0,6 \sim 0,8 \times 10^6$	5	5
$0,8 \sim 1,0 \times 10^6$	4	1
$1 \sim 1,2 \times 10^6$	5	0
$1,2 \sim 1,4$	2	1
$1,4 \sim 1,6$	5	0
$1,6 \sim 1,8$		
$1,8 \sim 2$		1
$2,7 \times 10^6$	1	
$3,1 \times 10^6$	1	

INSTITUT INTERNATIONAL DE PHYSIQUE SOLVAY

SEPTIÈME CONSEIL DE PHYSIQUE -- BRUXELLES. 22-29 OCTOBRE 1933



Photo Benjamin Couprie

29, avenue Louise, Bruxelles

H. A. KRAMERS

N. F. MOTT

G. GAMOW P. BLACKETT

M. COSYNS

Aug. PICCARD

E. STAHEL P. A. M. DIRAC

J. ERRERA

C. D. ELLIS

E. O. LAWRENCE

LA RADIOACTIVITE ARTIFICIELLE

Polonium

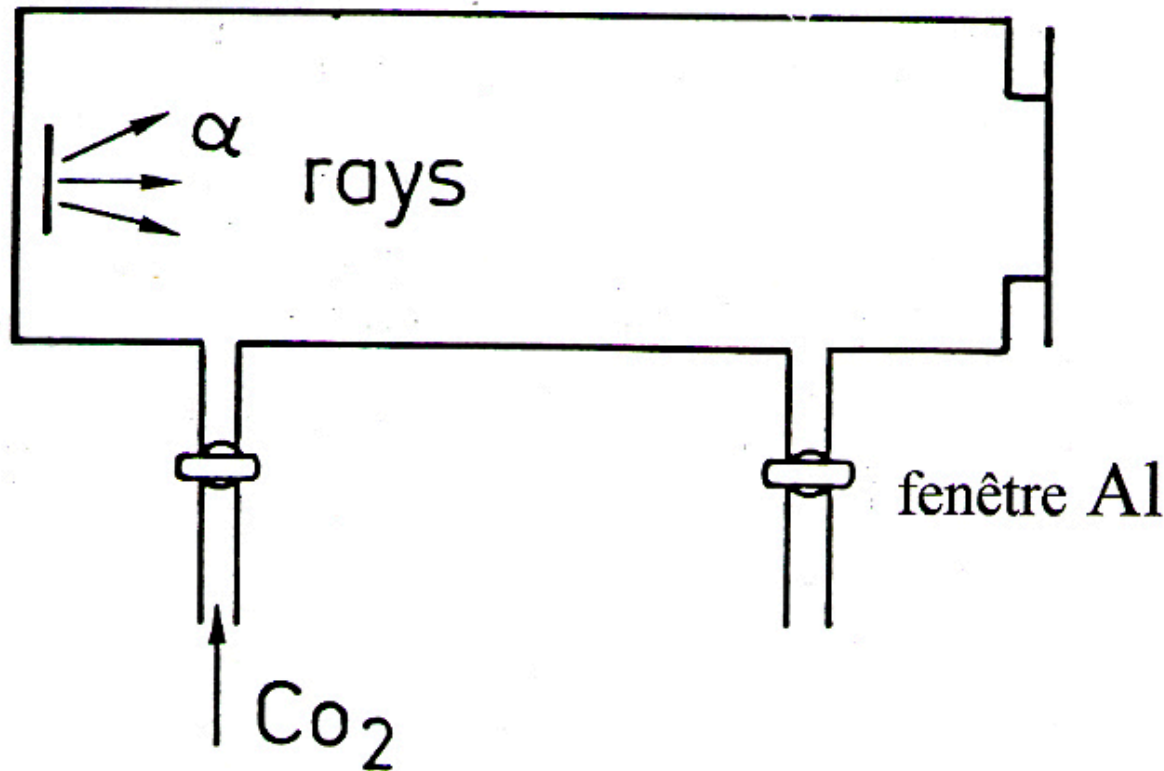

β^+ Compteur
Geiger-Muller

n Chambre
paraffinée

« Un nouveau type de radioactivité » 15 jan. 1934

29 jan. 1934 ^{30}P

RADIOACTIVITE

ARTIFICIELLE 1934

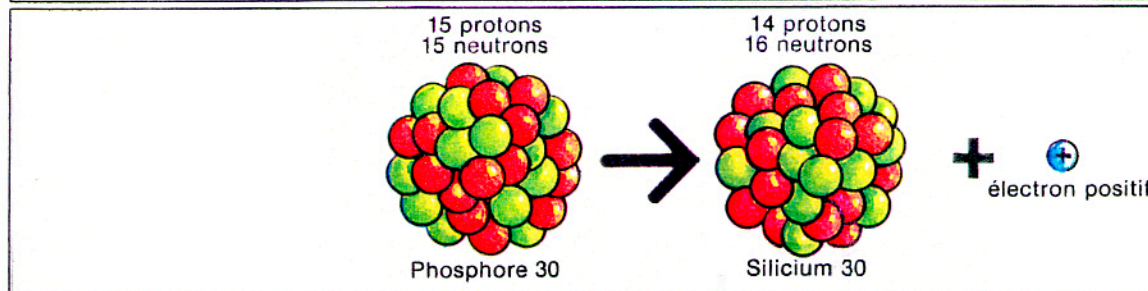
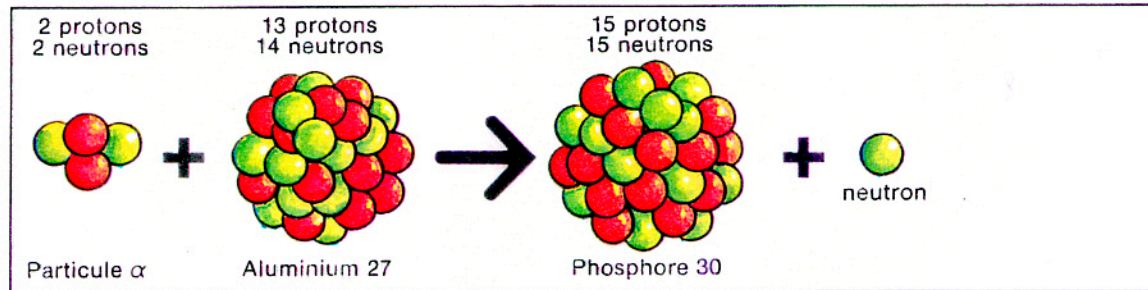
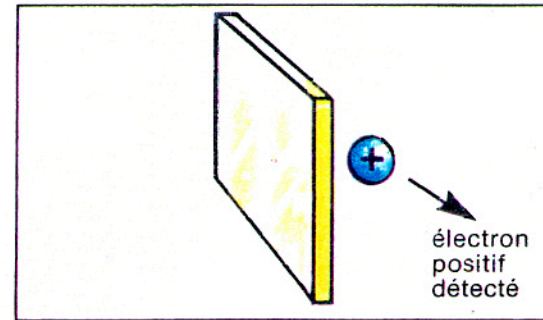
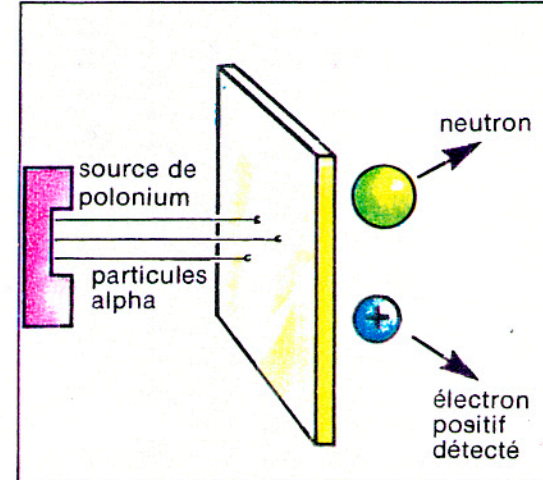



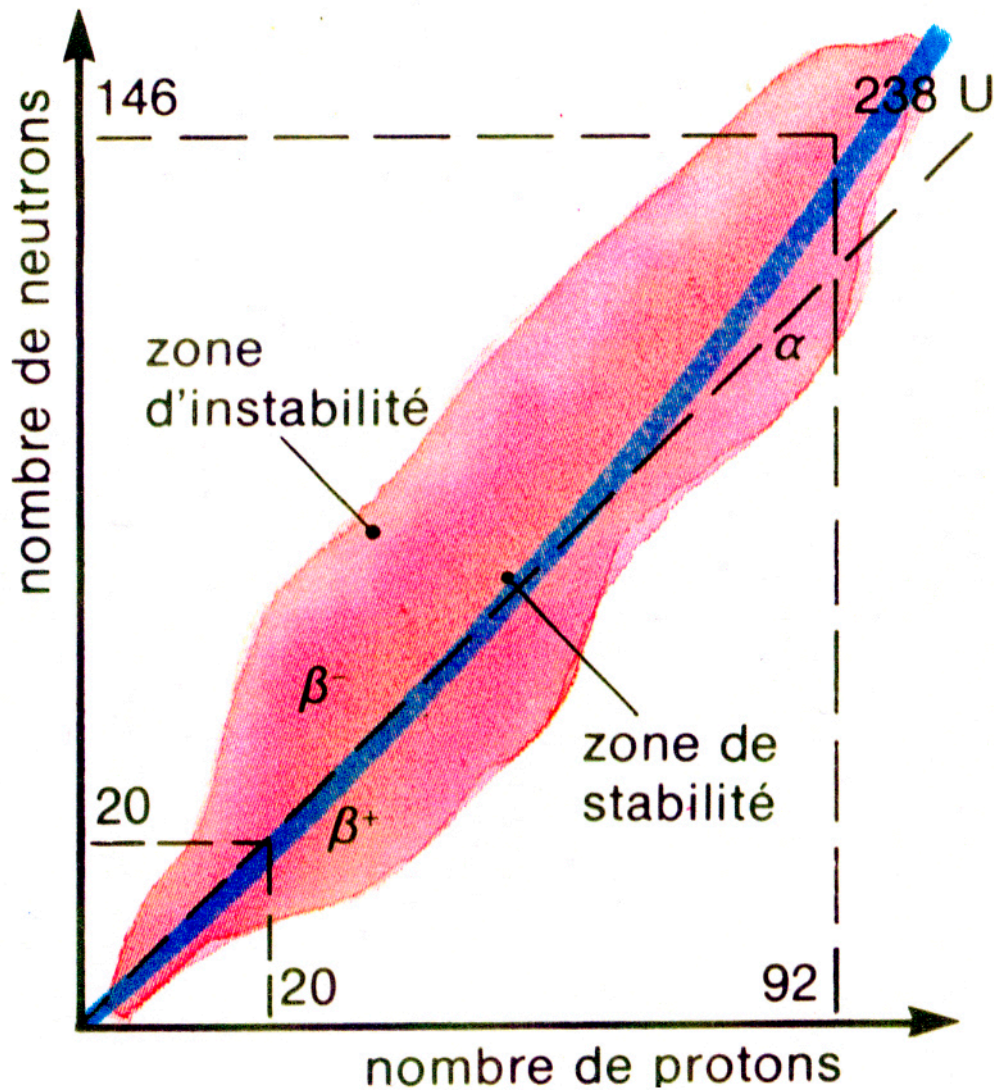

Indicateurs et biologie

1934 – 1939

Isotopes radioactifs
transuraniens ?

**PRODUCTION D'ENERGIE
ET SYNTHÈSE DES ÉLÉMENTS CHIMIQUES**
par
réactions nucléaires et désintégrations radioactives









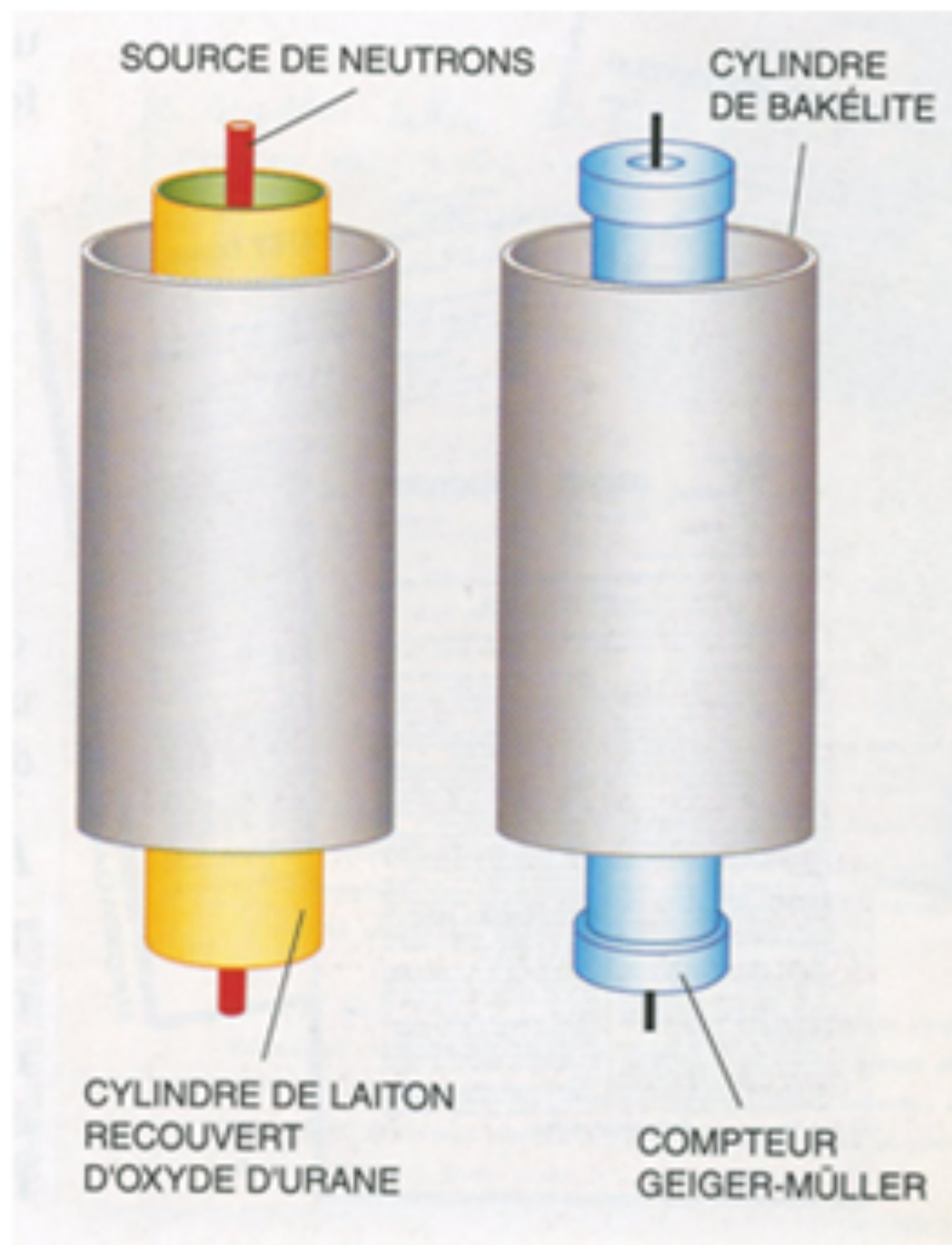

1939-1940

Déc 1948



