

Precise measurement of the W boson mass with the CMS detector at the CERN LHC

IPHC Strasbourg particle physics seminar

Kenneth Long

Introduction and motivation

- Masses, couplings are experimental inputs to the standard model
 - But relationships between parameters are **exactly predicted**
 - Direct measurements over-constrain the standard model

$$m_W^2 \left(1 - \frac{m_W^2}{m_Z^2} \right) = \frac{\pi\alpha}{\sqrt{2}G_\mu} (1 + \Delta r)$$

Very well measured

Higher-order corrections
Depend on $m_t, m_H, \dots m_{\text{BSM}}?$

- Most precise measurement of W boson mass from CDF, $m_W = 80,433.5 \pm 9.4$ MeV, in strong tension with expectation
 - And with other experiments... **new result needed!**

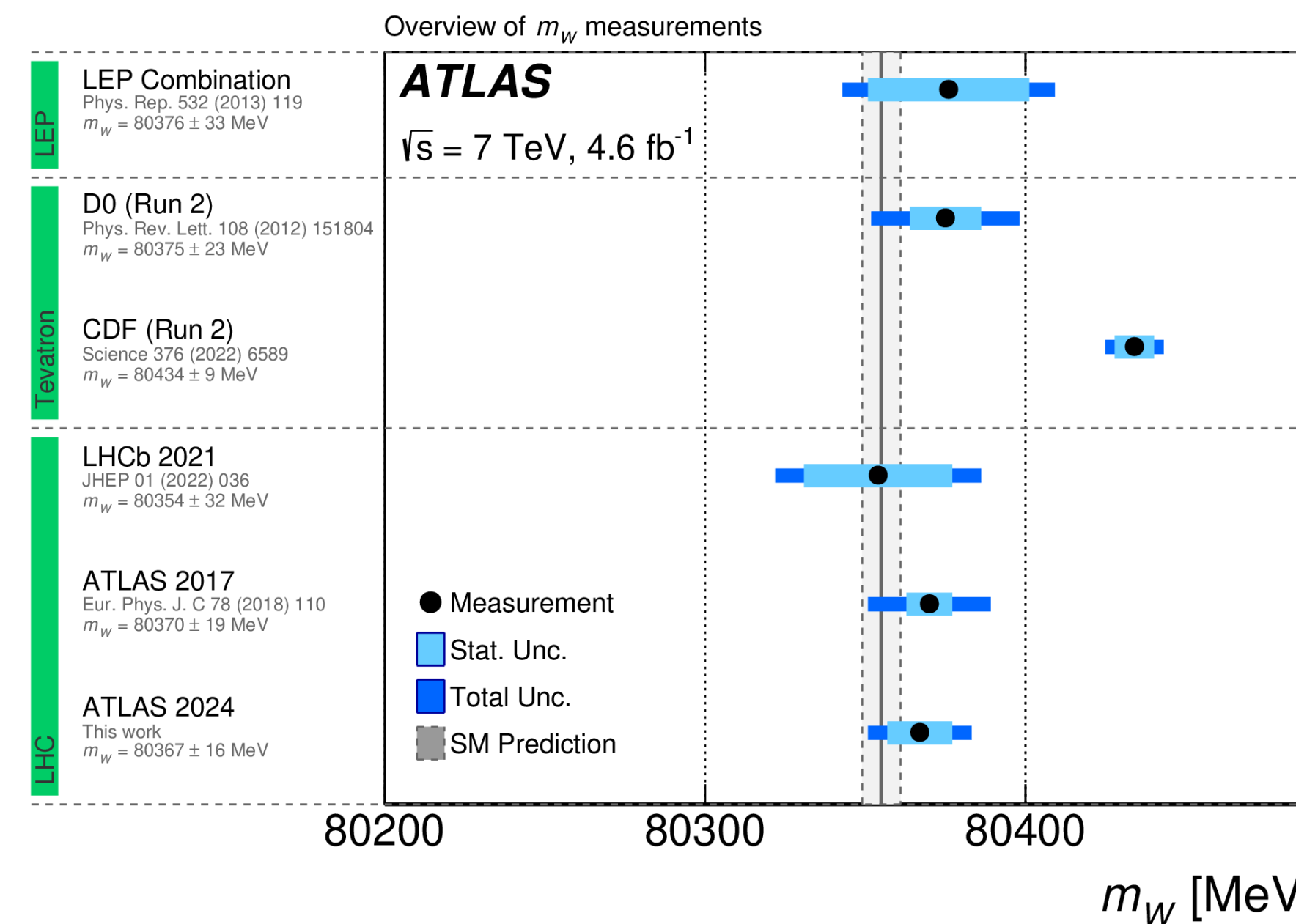
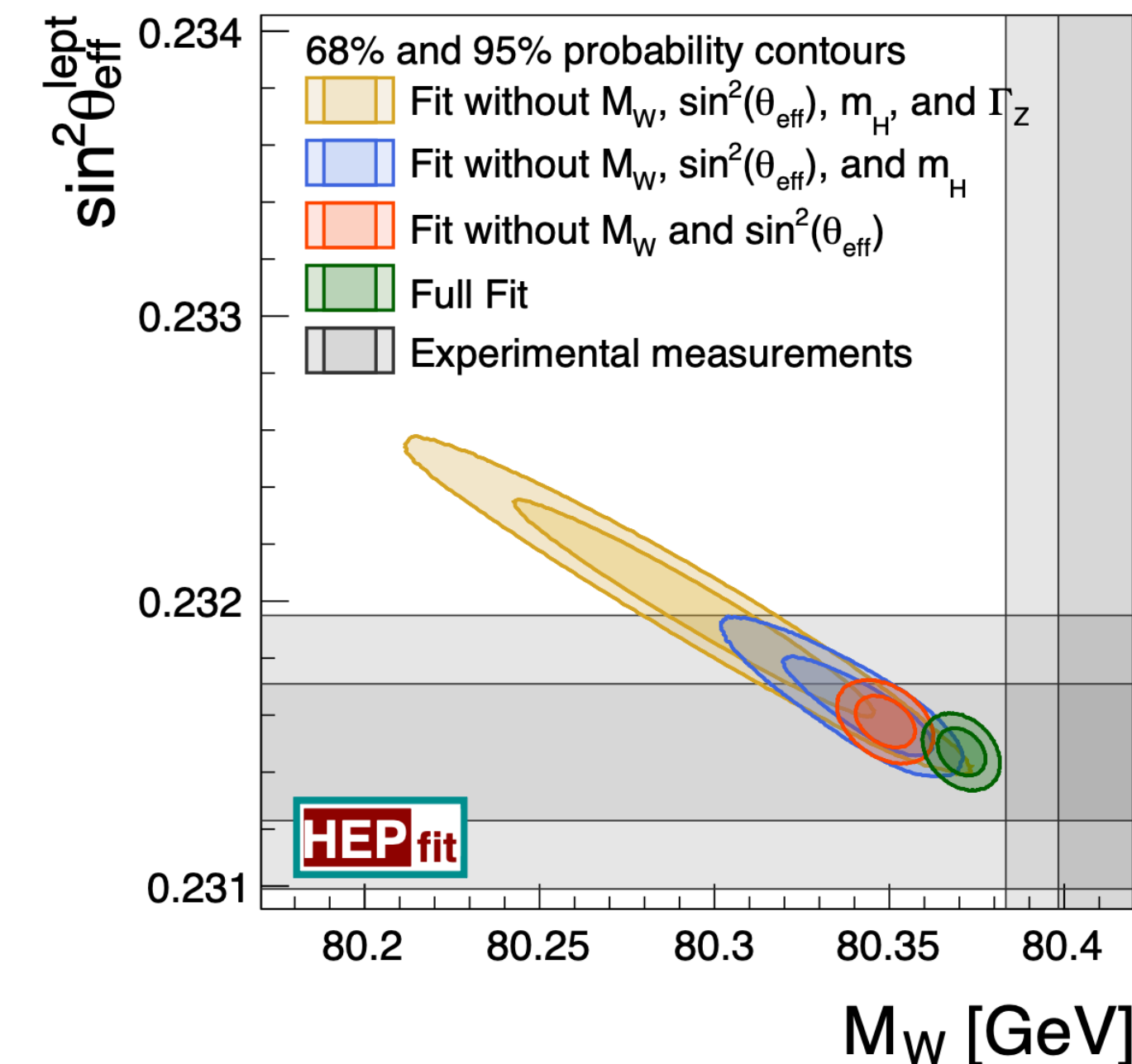

Mass measurements at colliders

- Measure short-lived resonances via their decay productions
 - Measure momentum in detector, mass from four-momentum conservation
- Alternatively: scan production rate vs. beam energy scan
 - Very precise m_Z measurement at LEP
 - Parton energy not directly controlled at hadron colliders

➔ Measurement of $m_W \sim 7x$ less precision than m_Z

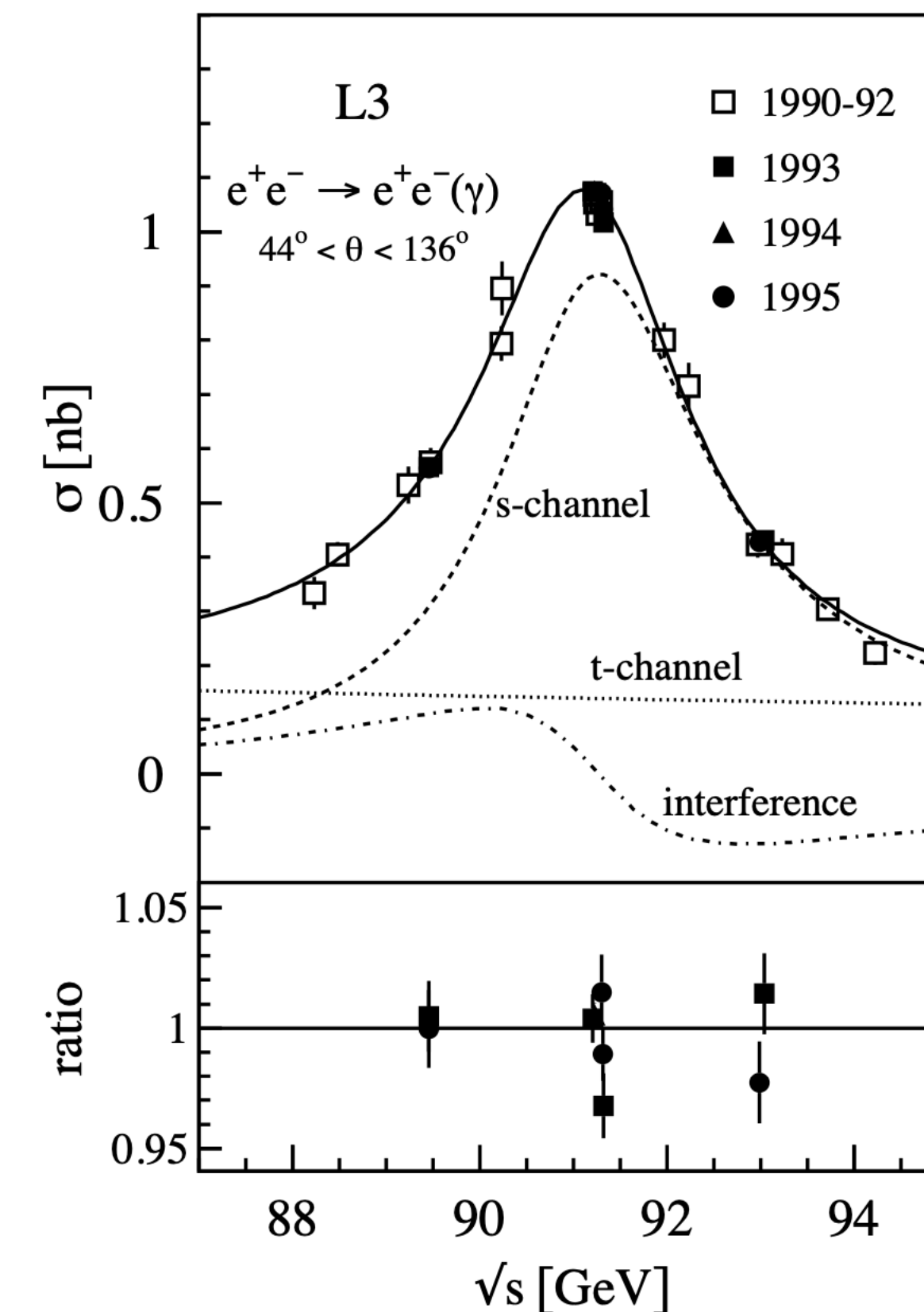
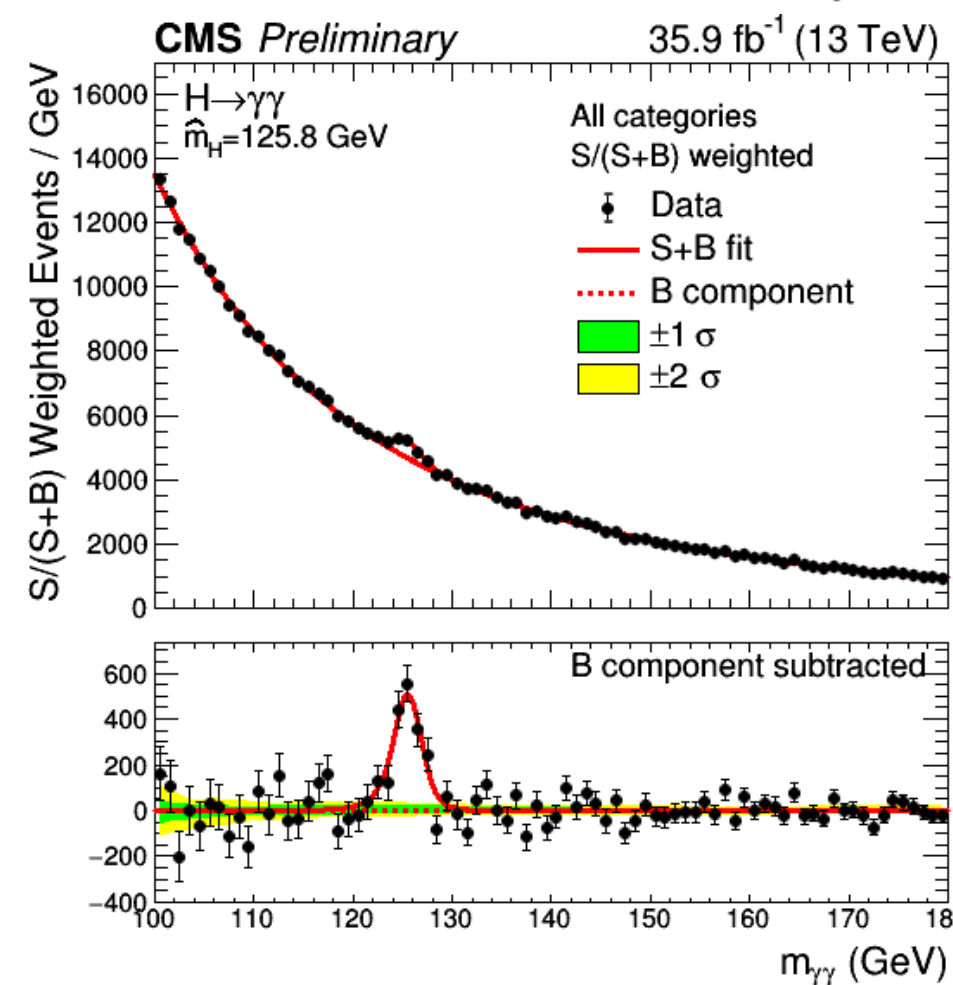
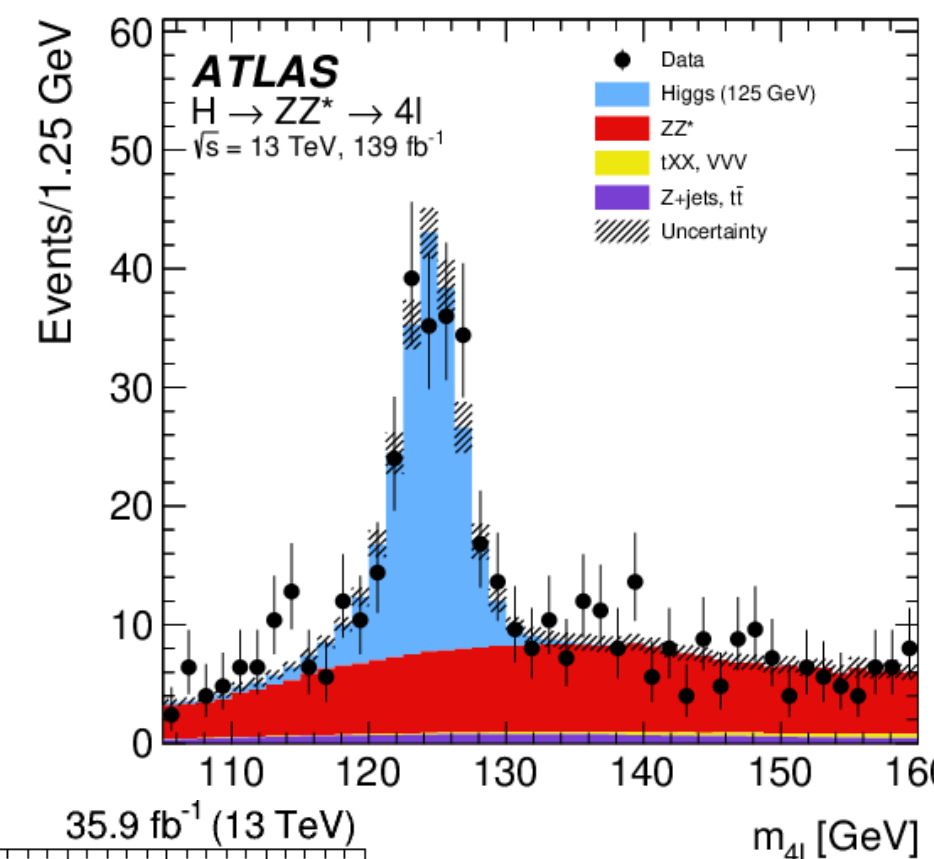
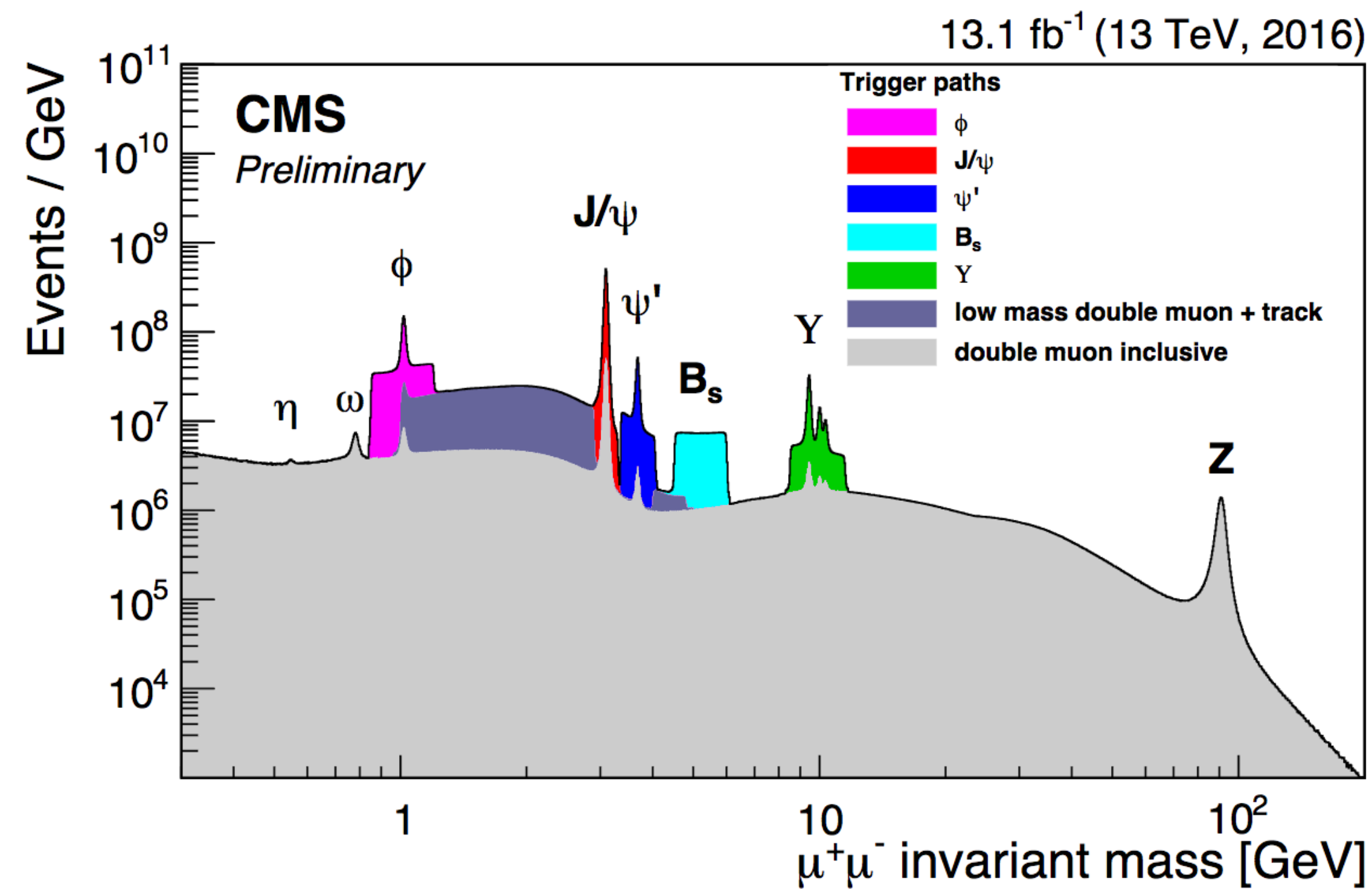
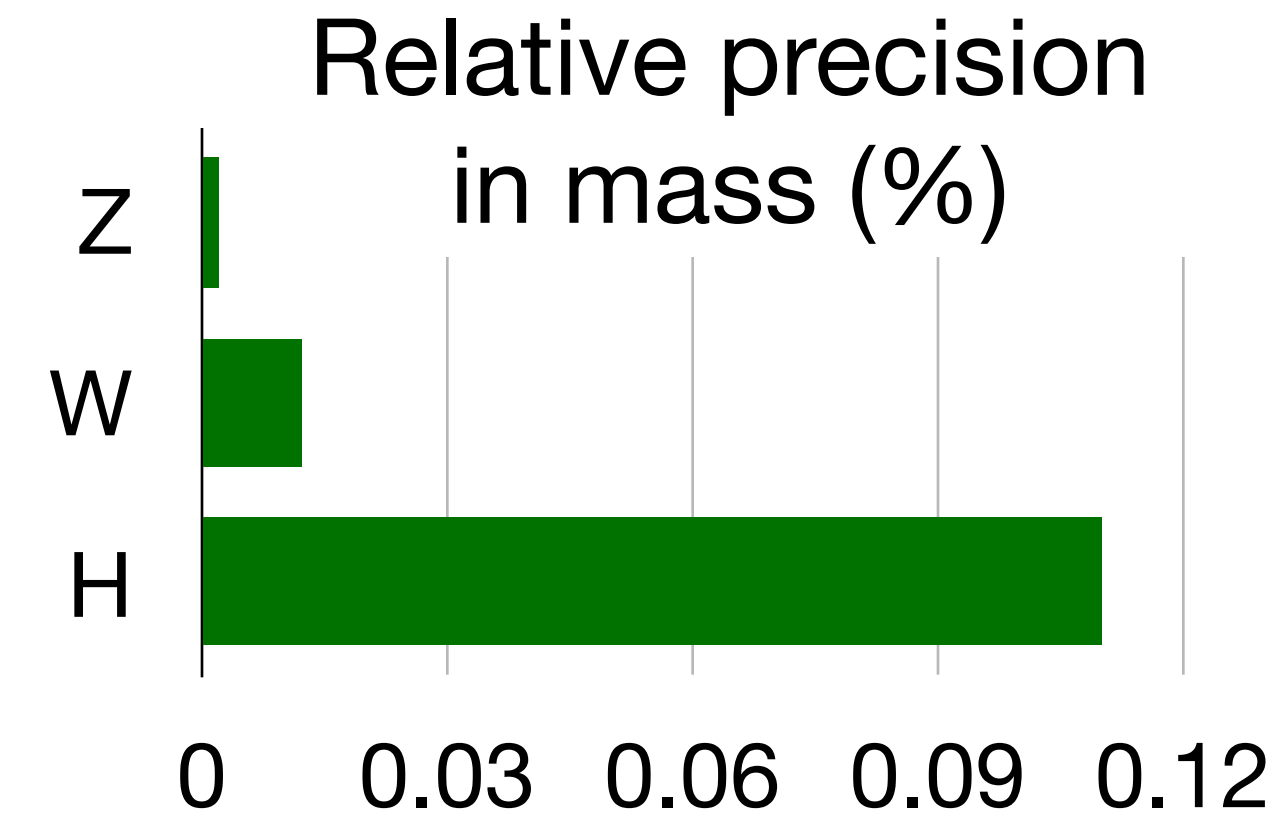

Directly reconstructing the W boson

- If all decay products are measured, little dependence on W production
 - Direct reconstruction of W possible with hadronic decays
 - Precise measurement at LEP using $ee \rightarrow WW \rightarrow qqqq$ (or $qq\ell\nu$) events
 - Background/calibration of jet momentum more complex in hadron colliders
- ➔ Only lepton+neutrino decay is practical
 - Introduces dependence on W production

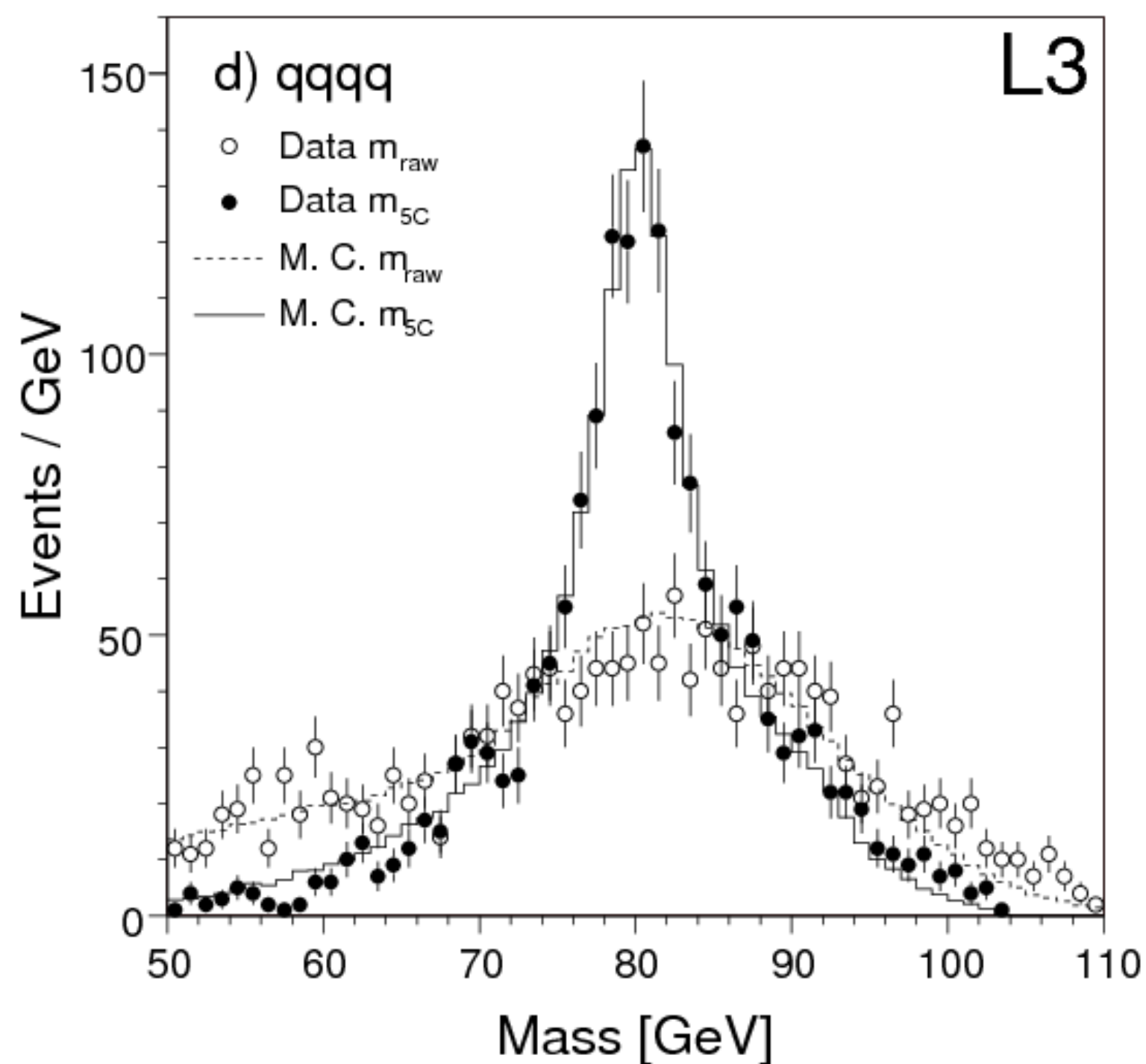
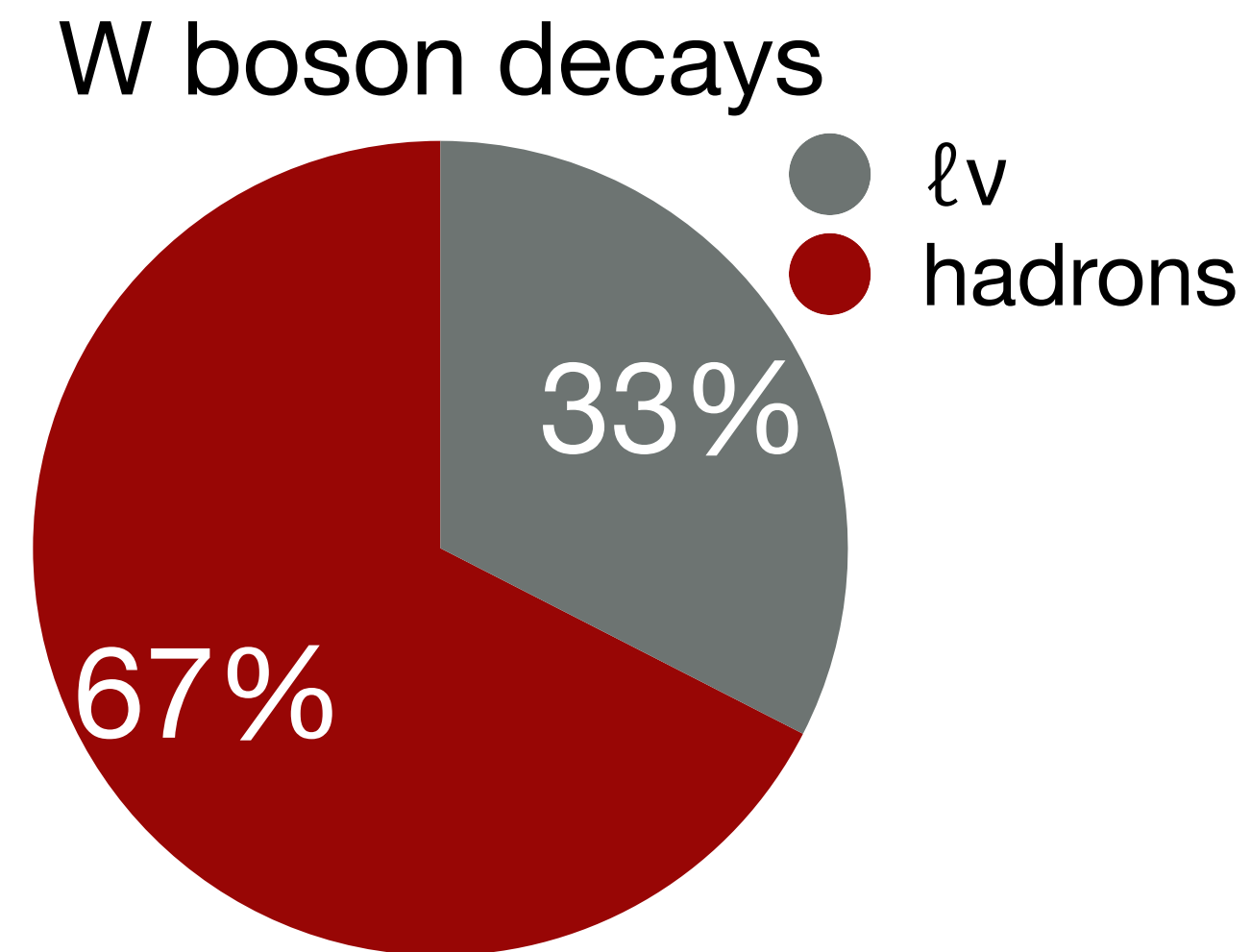

LEP (L3)
vs.
LHC (CMS)

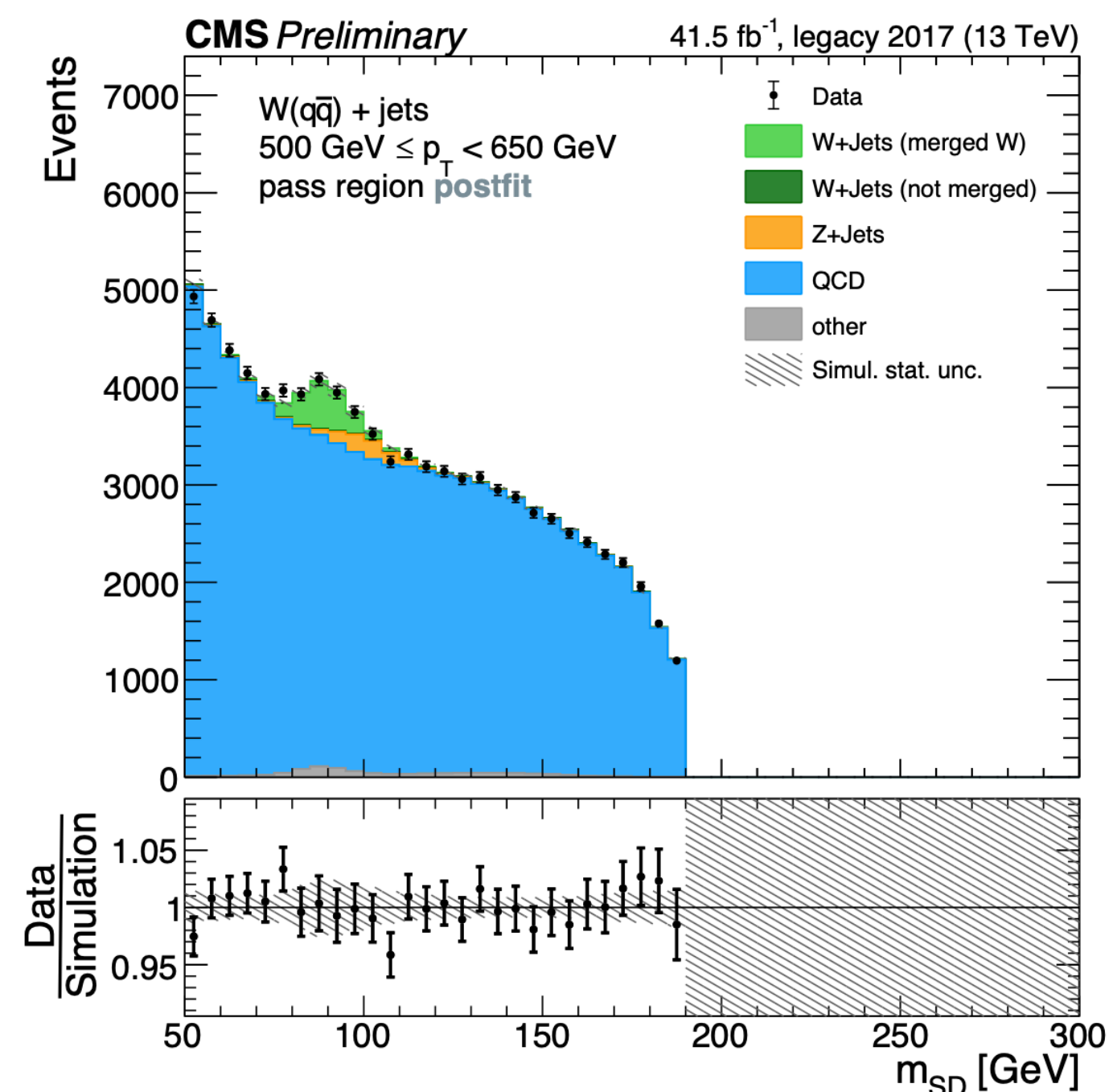

Measuring m_W at hadron colliders

- Rely on observable(s) sensitive to m_W built from measurable objects
 - Requires subpercent-level control of theoretical and exp. inputs

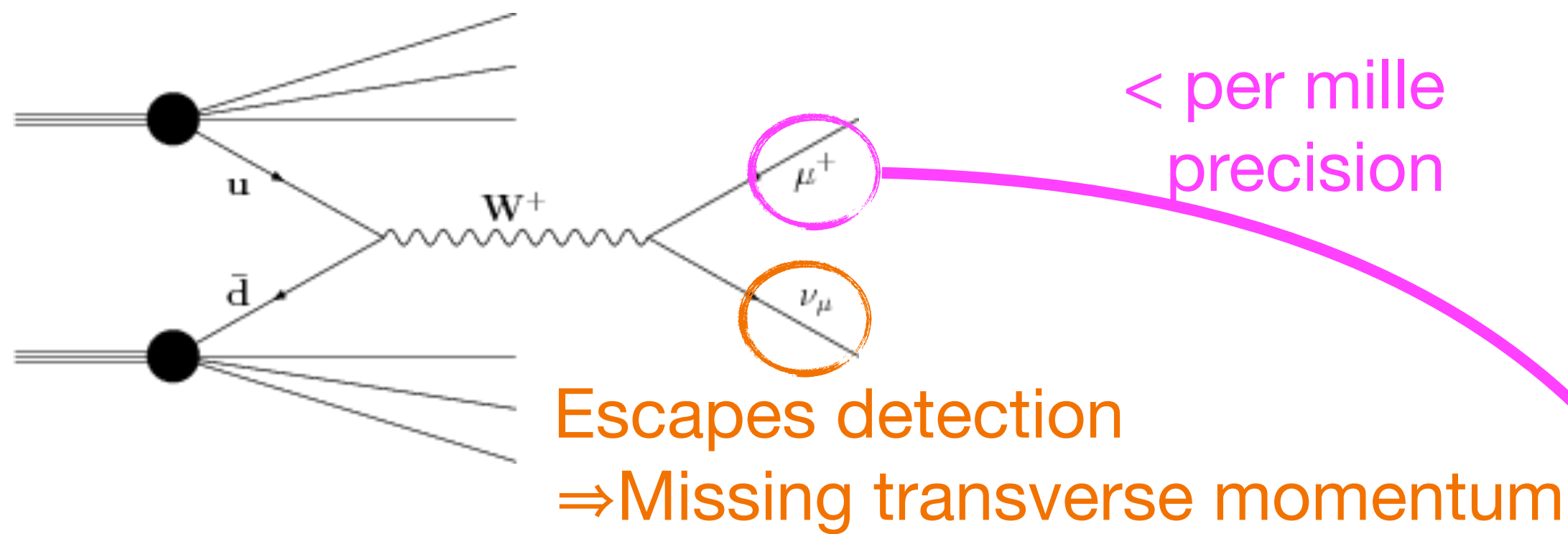

- Mass is equally divided between μ and ν
 - In rest frame, $p^\nu \sim p^\mu \sim m_W/2$
 - In lab frame, smeared by p^W
- ➔ Knowledge of W momentum required

$$m_T^W = \sqrt{2 p_T^\mu p_T^{\text{miss}} (1 - \cos \Delta\phi_{\ell\nu})}$$

- Jacobian peak at m_W
- Reduced dependence W production

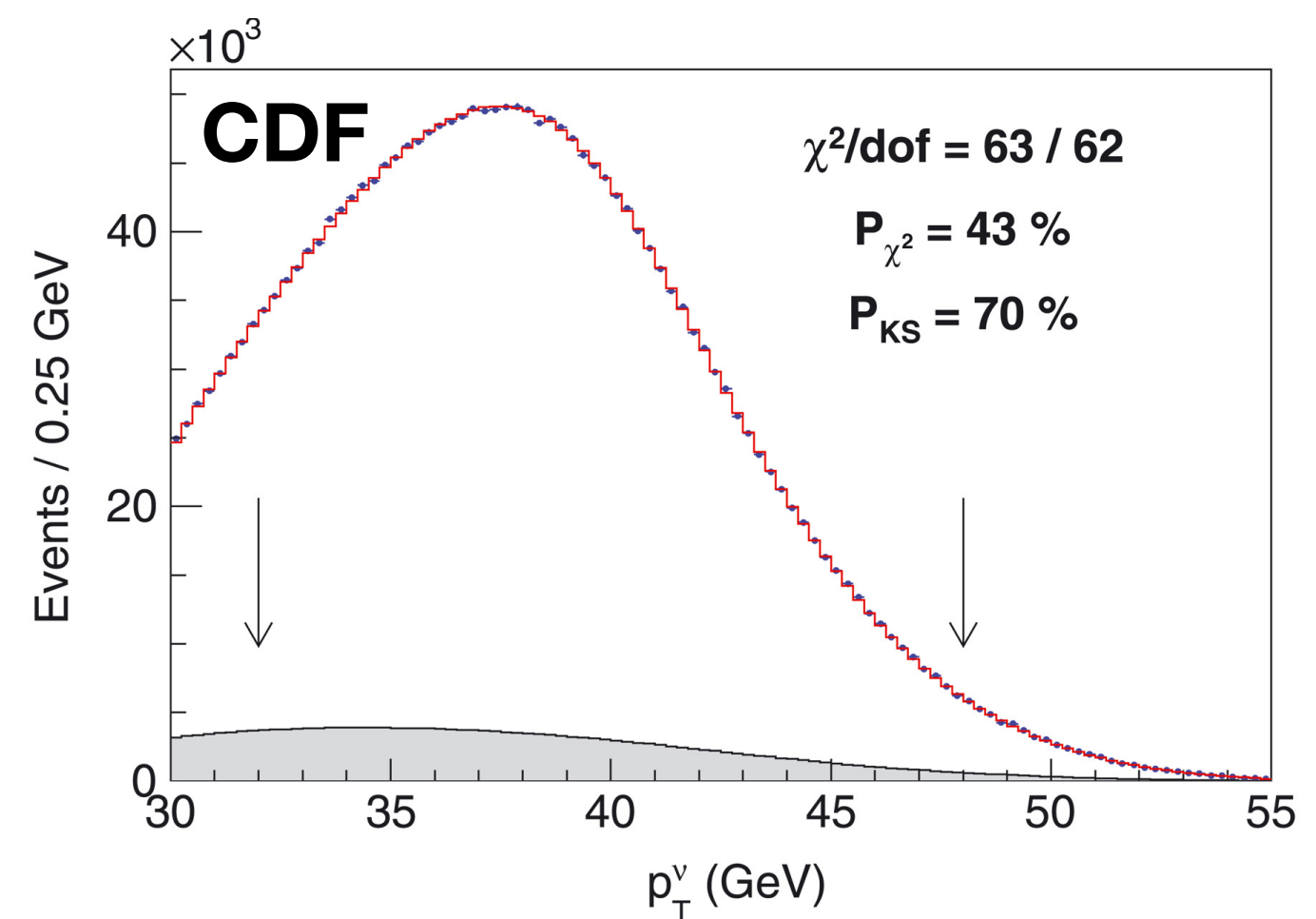
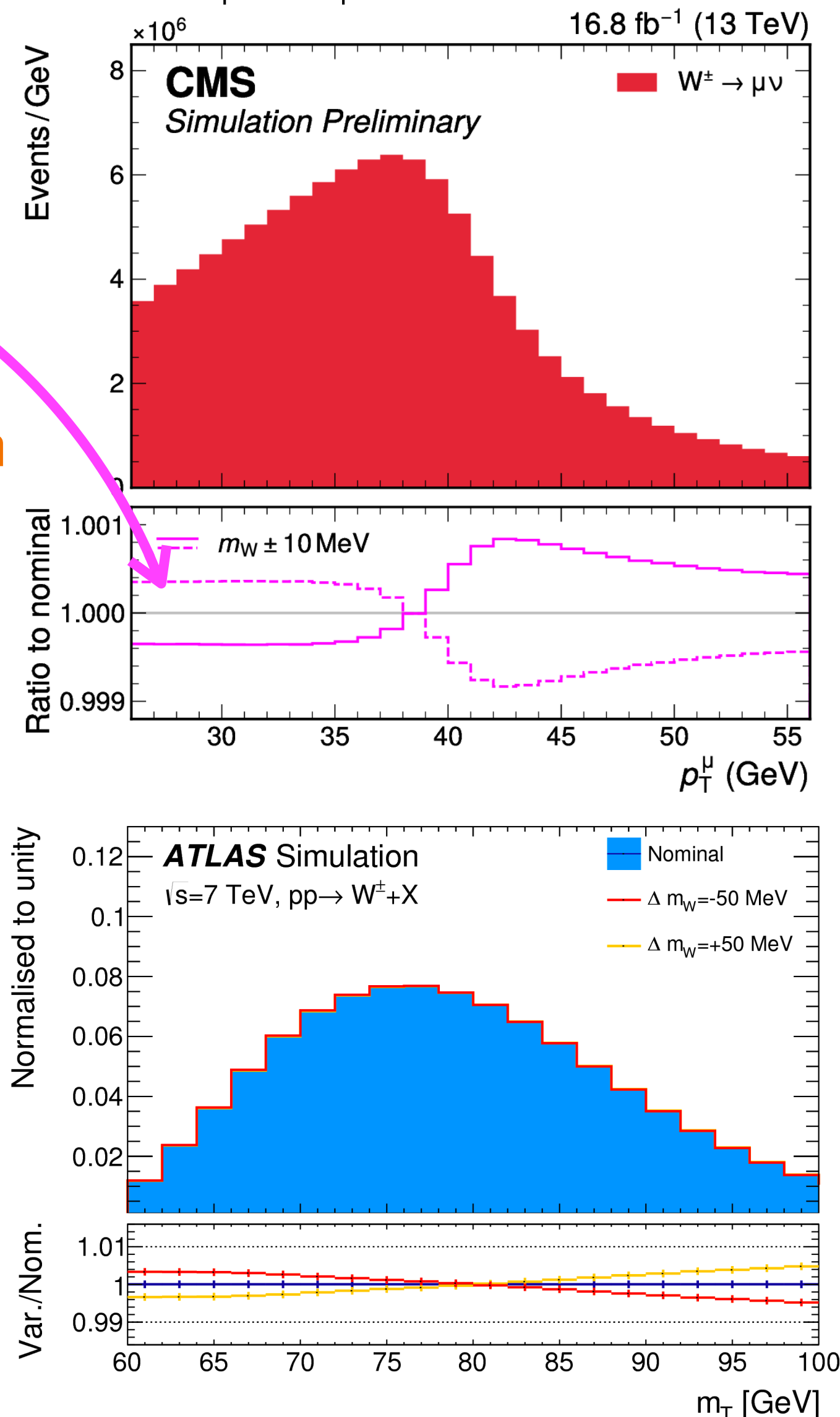

- p_T^{miss} estimates p_T^ν
- Precise p_T^{miss} reco. very difficult at LHC

W and Z boson production at the LHC

- Final state is not fully reconstructed \Rightarrow sensitive to W production
- p_T^W not directly measured w/high precision at LHC
- \Rightarrow Rely on theory
- Validate with Z boson measurements

Z production

W production

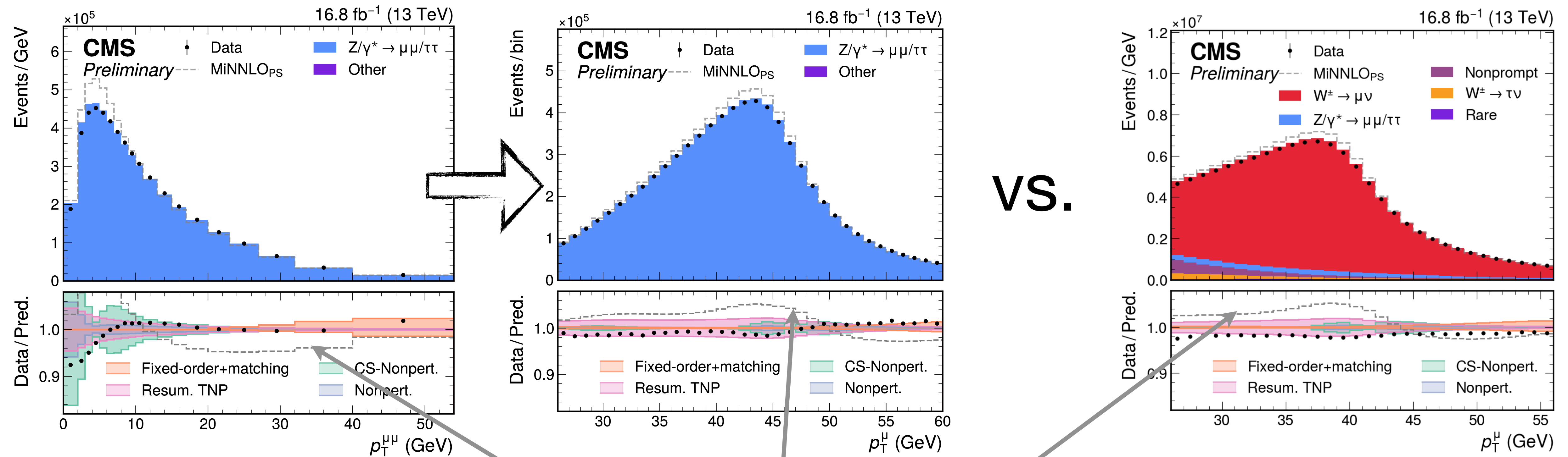

Uncertainties, corrections can be much larger than m_W variation!

Particle reconstruction with the CMS detector

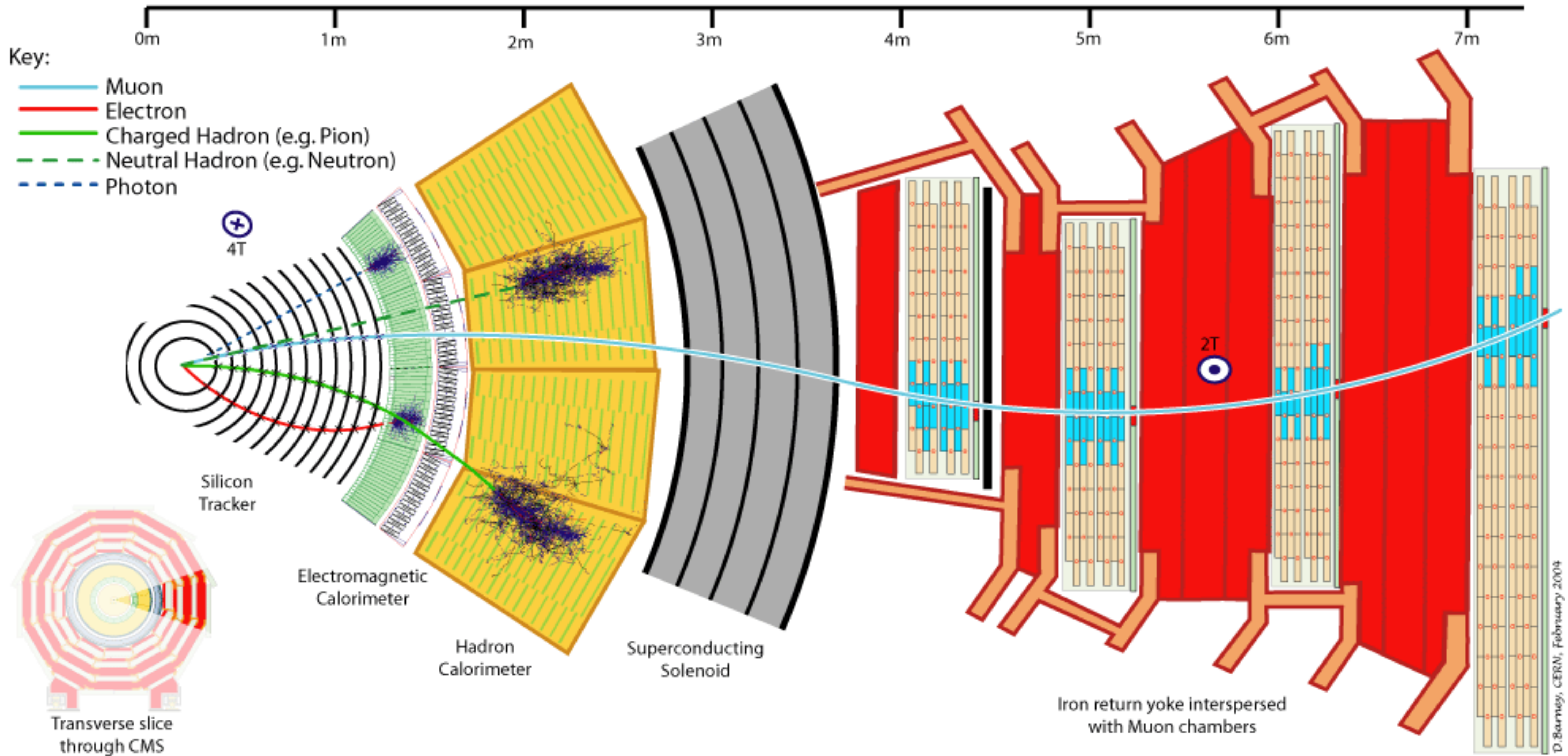

- high B-field, excellent silicon tracker + muon system \Rightarrow precise μ measurement
- Hadronic jets from clustering individual particle candidates
- Neutrino transverse momentum from conservation of momentum

- 16.8 fb⁻¹ of 13 TeV data collected in 2016
 - Small fraction of LHC data but largest-ever for m_W analysis
 - Also highest pileup ever used (~25)
 - Especially challenging for p_T^{miss} measurement
- ★ Focus measurement on p_T^μ channel
- Select events with exactly one muon
 - 26 < p_T^μ < 56 GeV
 - Good track+muon system track, isolated from hadronic energy
 - m_τ > 40 GeV
 - ~100 M selected W events
- Prompt backgrounds from simulation
 - Z → μμ (mainly with 1 out-of-acceptance μ)
 - W → τν and Z → ττ, with τ decays into μ
 - Rare: top quark, boson pair production, photon-induced
- Nonprompt background estimated from data
 - Mainly QCD multijet events with B/D decays in flight
 - Suppressed by m_τ cut

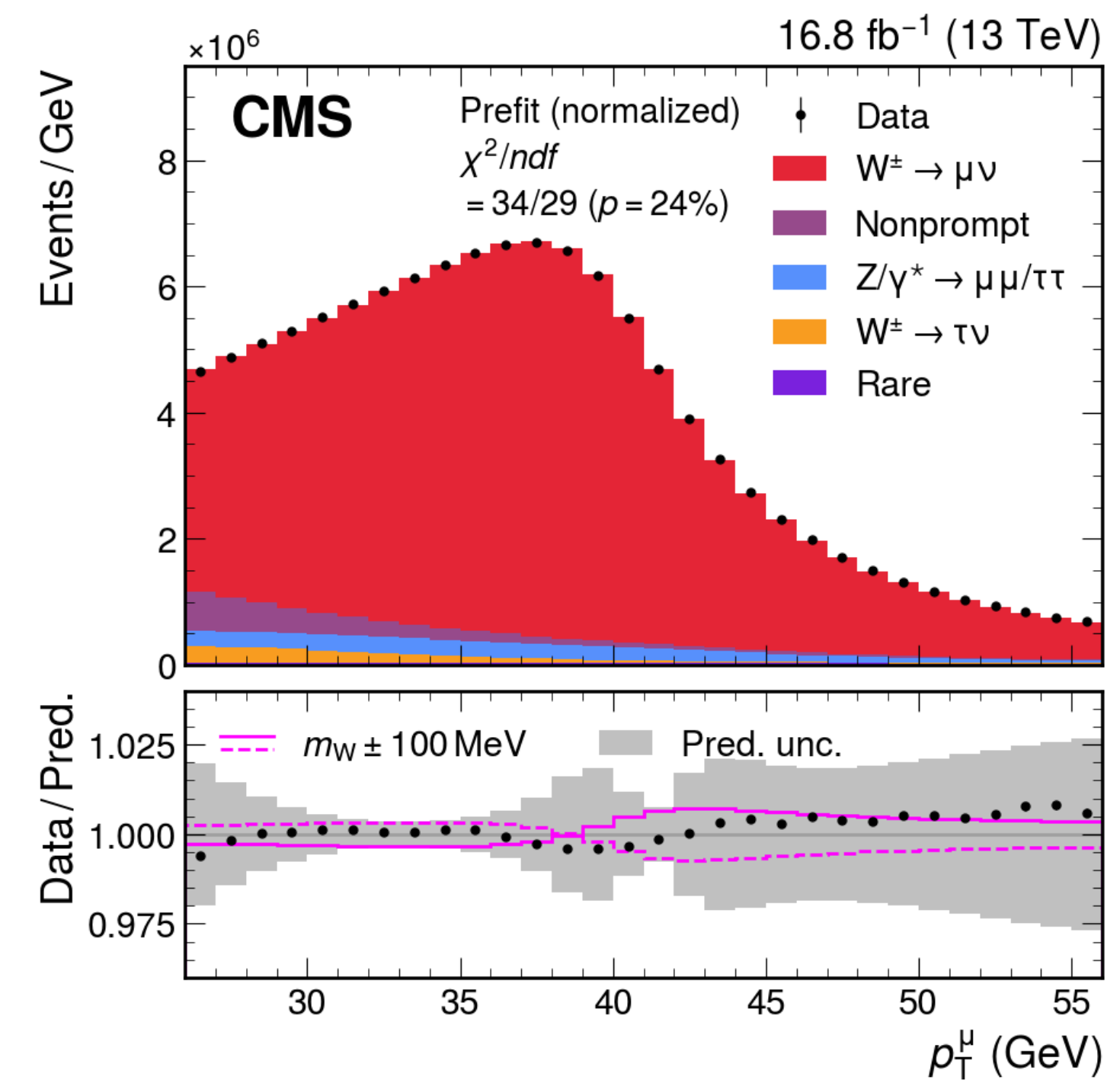
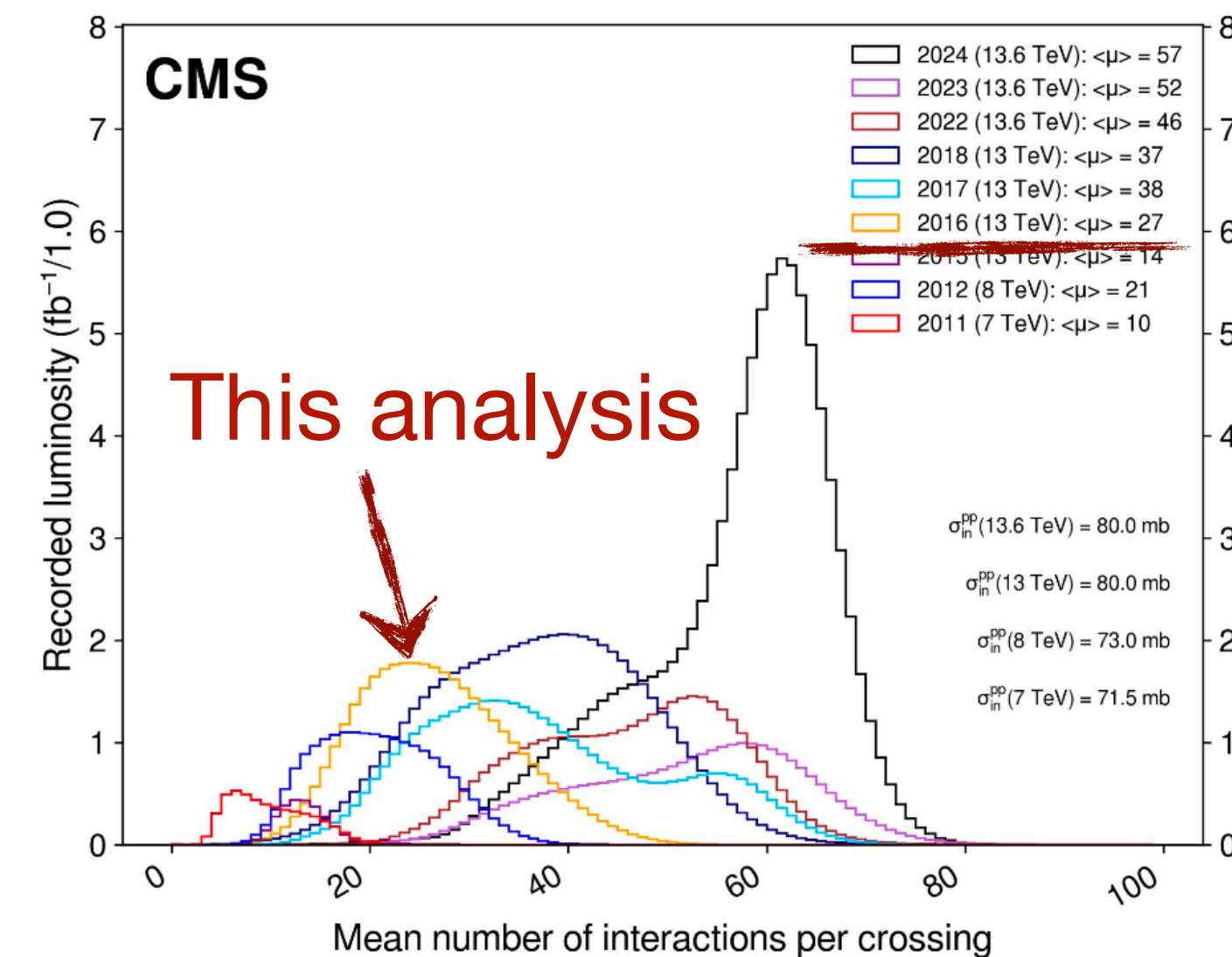



Measuring $W \rightarrow \mu\nu$ at CMS



Pileup \propto Number of vertices = 22

Very precise μ reconstruction

ν not directly reconstructed

<https://cds.cern.ch/record/2909335>

m_W measurement at a glance

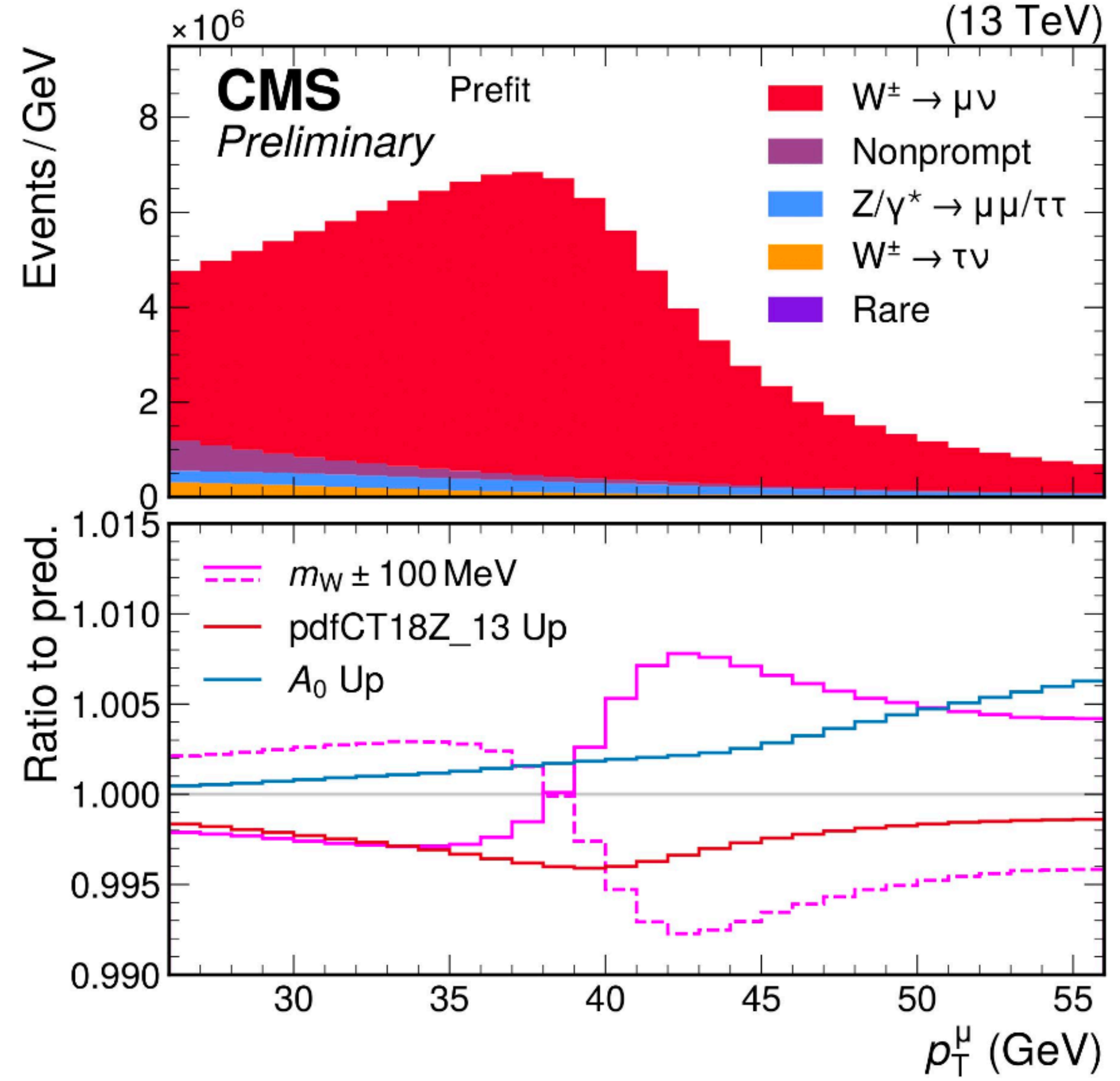
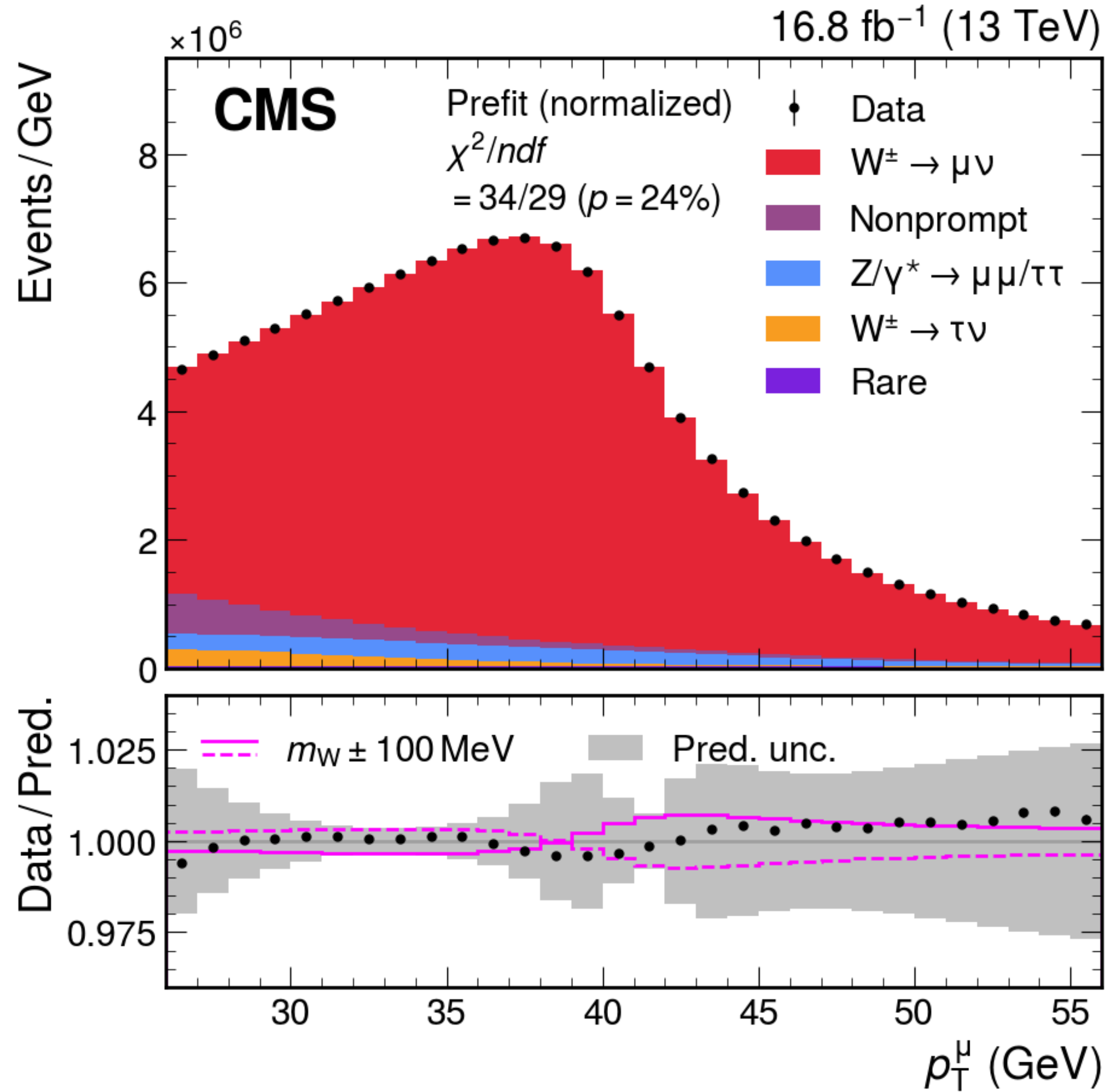

- Measurement performed *blinded*
- Results from binned maximum likelihood fits
- m_W (m_Z) variation computed at matrix-element level in simulation: unconstrained parameter-of-interest from fits

The m_W measurement at CMS

- $y^W(\eta^\mu)$, is dependent on W helicity, driven by PDFs
 - Sensitivity to PDF from η^μ
- ➔ Extract mass from fit to $(q^\mu, \eta^\mu, p_{T^\mu})$ distribution
 - ~2000 bins and 4000 nuisance parameters
 - Major computational challenge ([CERN IT seminar](#))
- Rely on theoretical predictions+unc. for W production
 - ➔ Z boson purely for validation

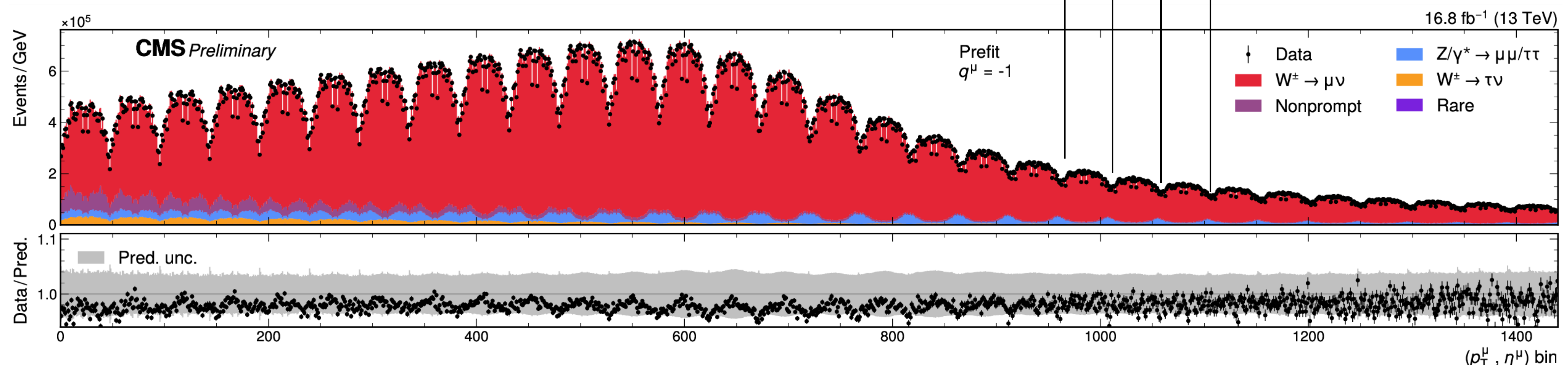
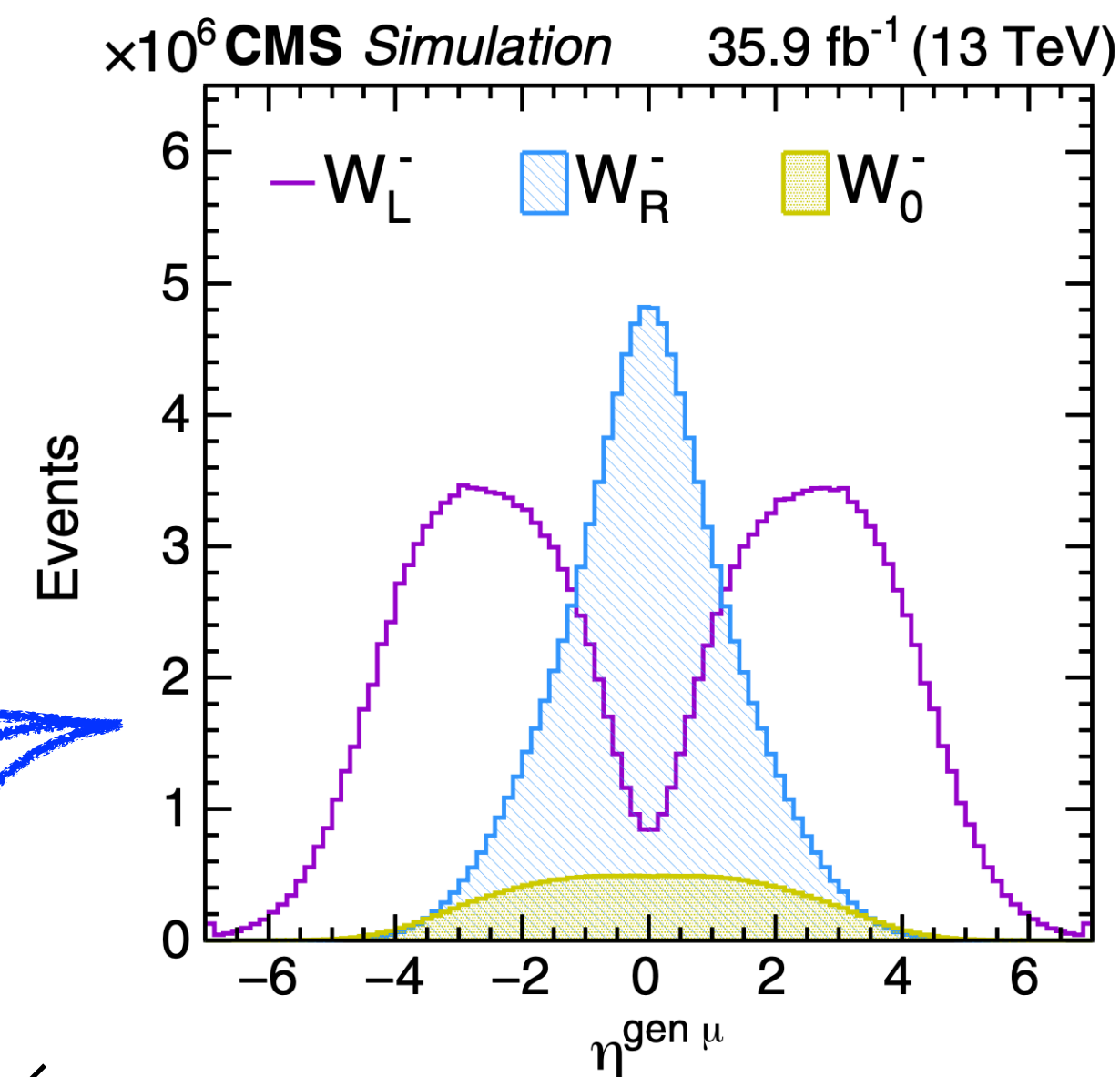
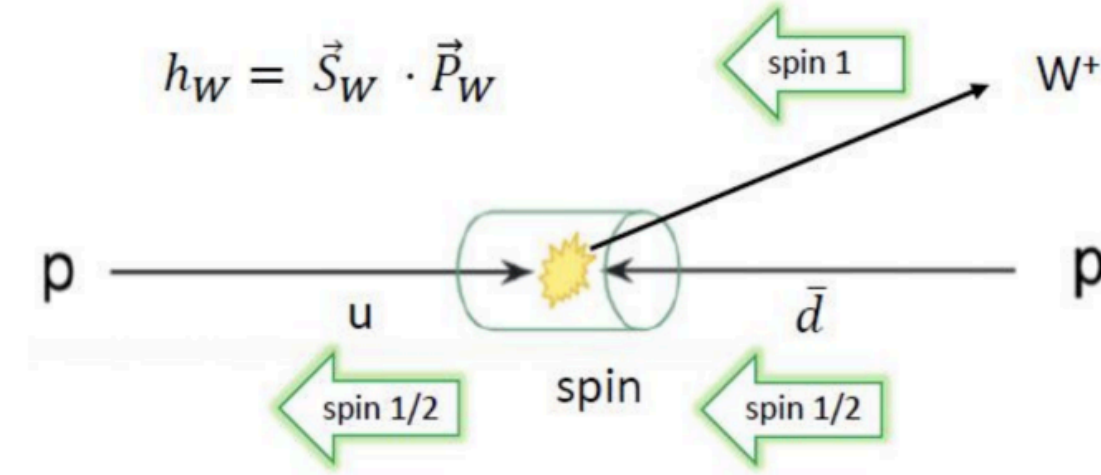

1D visualisation of 2D distribution: η^μ in 1 GeV bins of p_{T^μ} from 26-56 GeV

- Crucial tool to validate m_W extraction
 - Select Z events
 - Discard one lepton (add to p_T^{miss})
 - Measure m_Z with single-lepton kinematics
 - Cross-check with direct measurement of m_Z (and m_Z world average)
- Selection maximally consistent with W analysis
 - Take ℓ^+ (ℓ^-) in even (odd) events
 - Reject event if selected lepton is not the object that triggered event

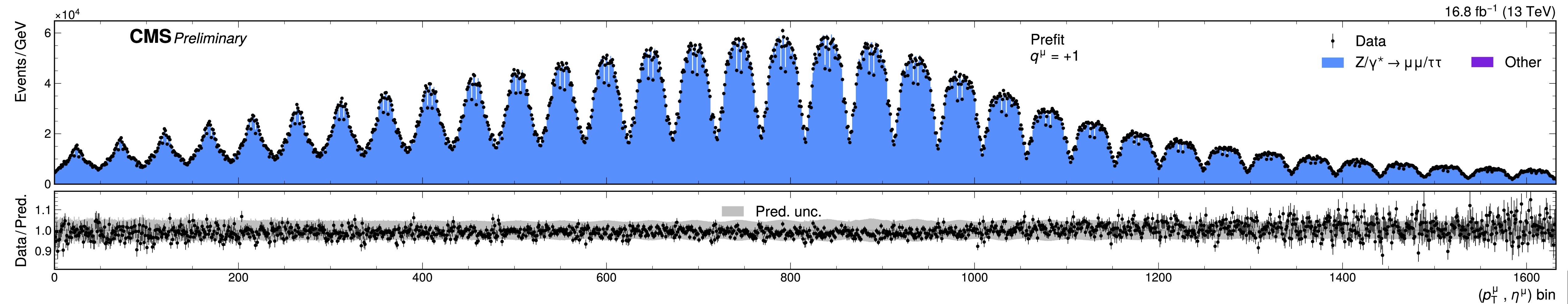
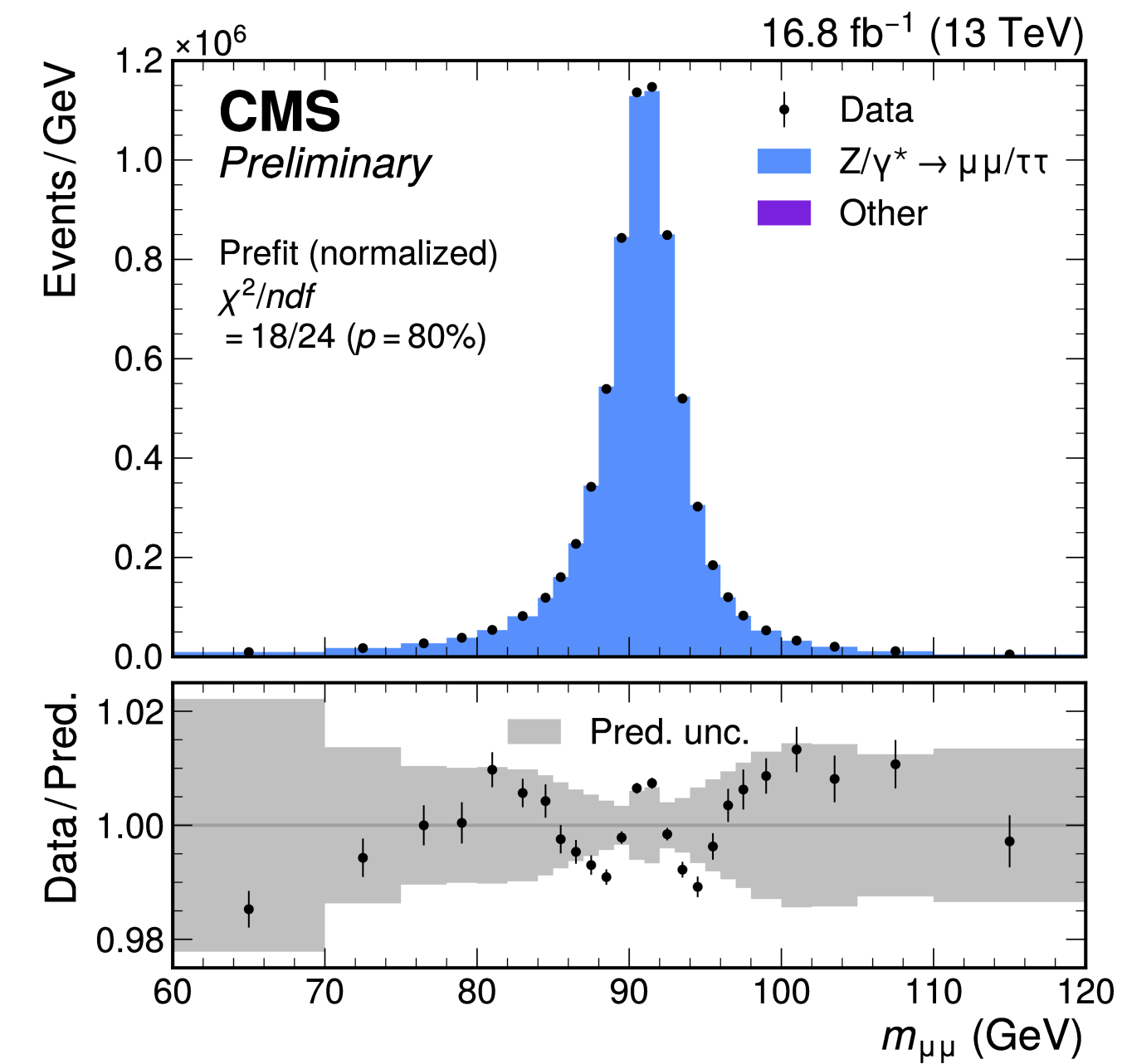

1D visualisation of 2D distribution: η^μ in 1 GeV bins of p_T^μ from 26-60 GeV

➔ The m_W measurement is the culmination of an extensive program

★ ★ ★ Highly granular and precise estimation of μ reconstruction efficiency

★ ★ ★ Calibration of absolute $p_{T\mu}$ scale ($\delta p_{T\ell} \sim 10^{-4} \Rightarrow \delta m_W \sim 8$ MeV)

➔ $> \times 10$ better than typical CMS analysis

★ ★ Accurate modeling and uncertainty estimation for W/Z production

★ ★ Calibration of the $p_{T\text{miss}}$

★ Estimation of backgrounds

- primarily heavy flavour decays in jets mis-ID'd as leptons)

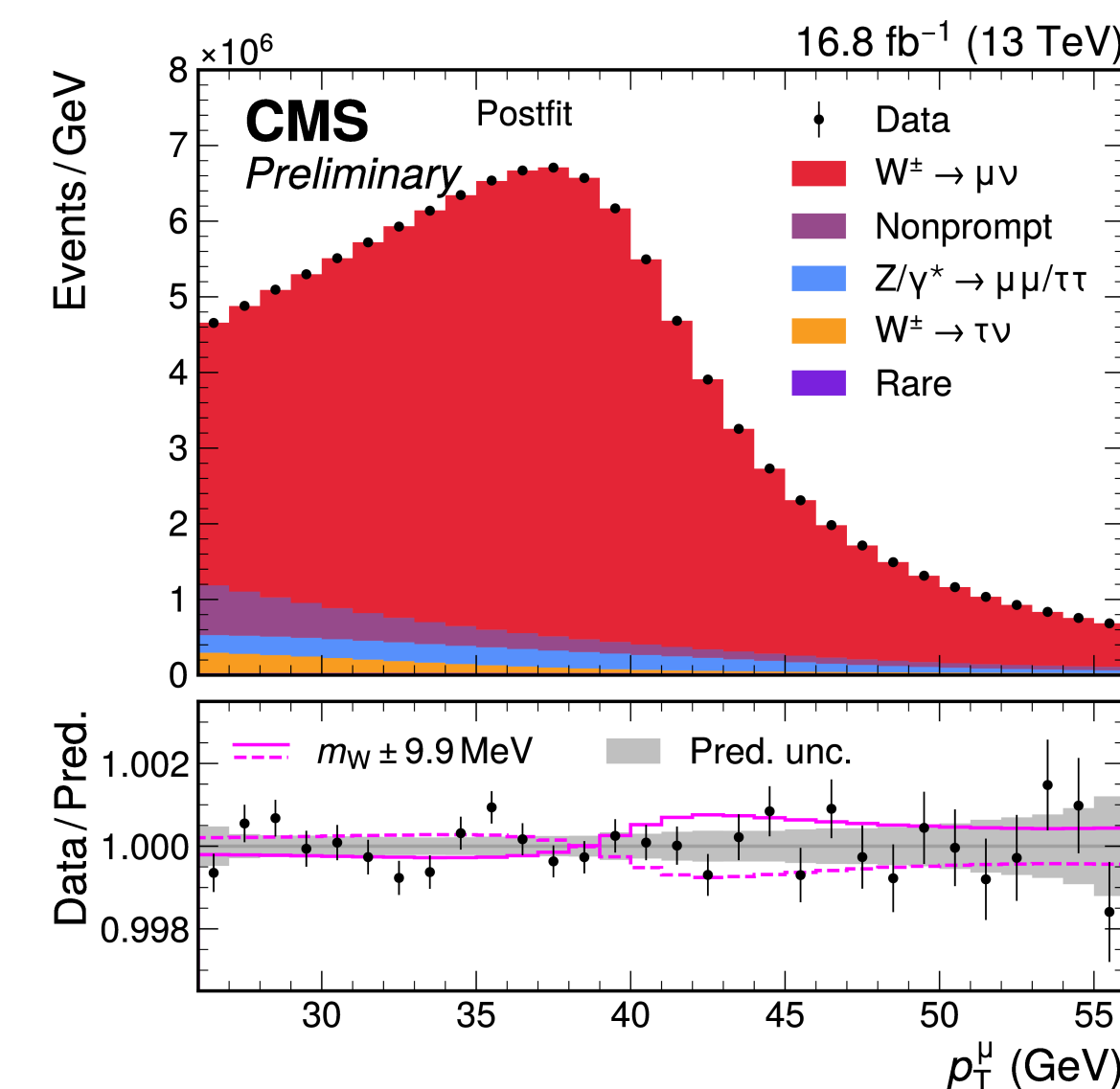
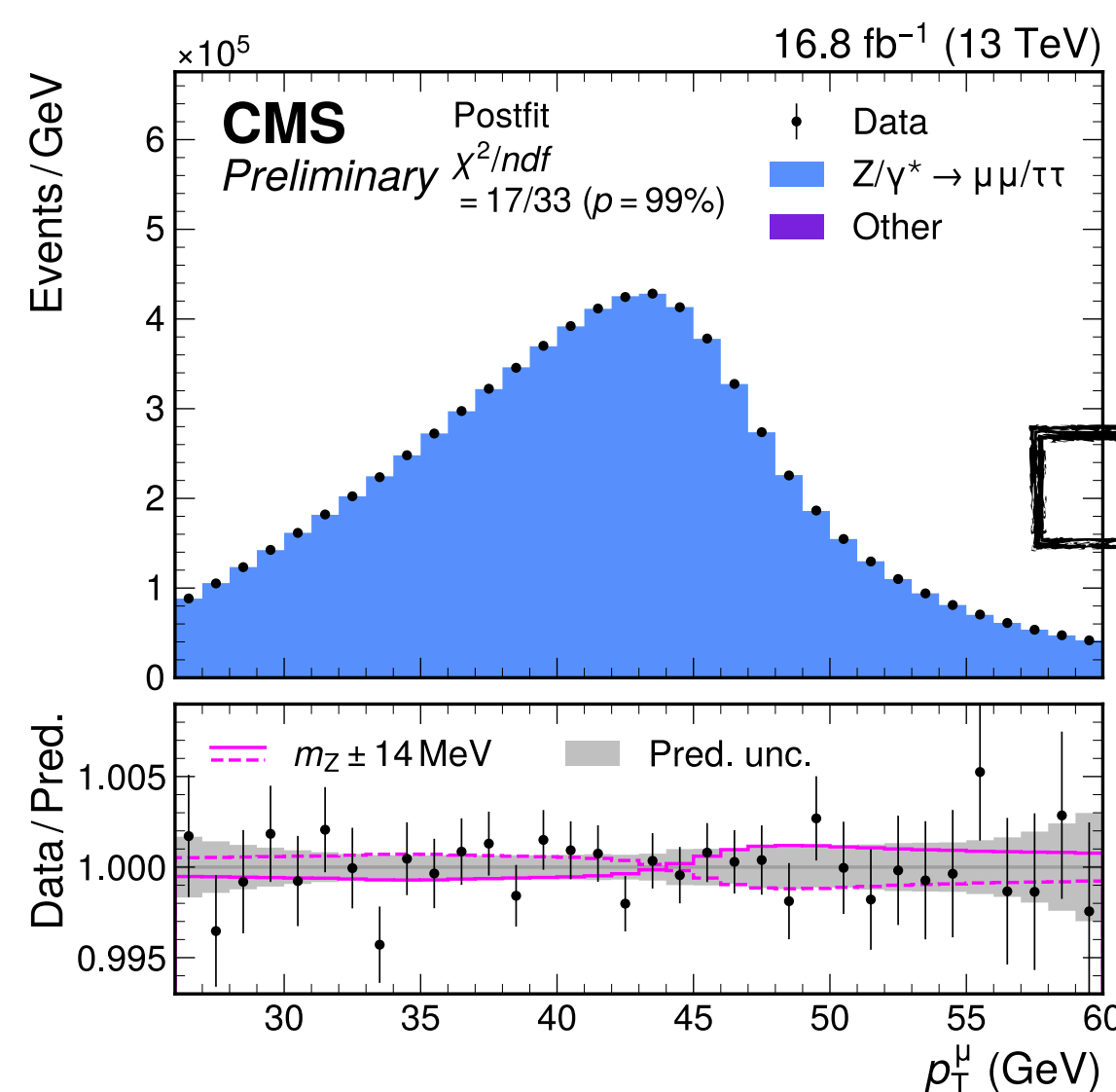
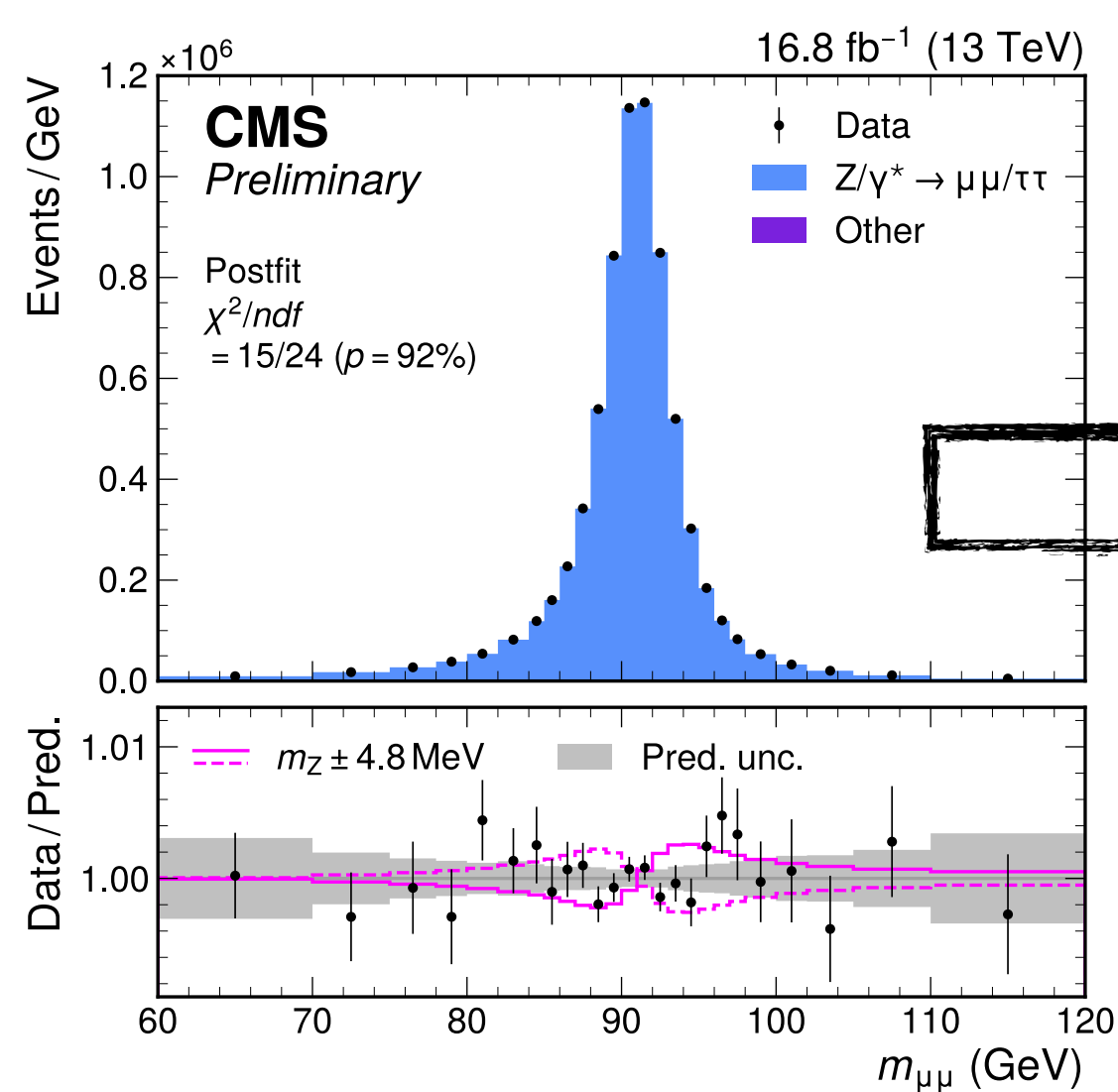

★ m_Z measurement from $m_{\mu\mu}$

★ m_Z measurement from $p_{T\mu}$

★ m_W measurement

Muon momentum calibration

muon

$$F = qV \times B$$
$$\Rightarrow p_T = qBR$$

Tracker

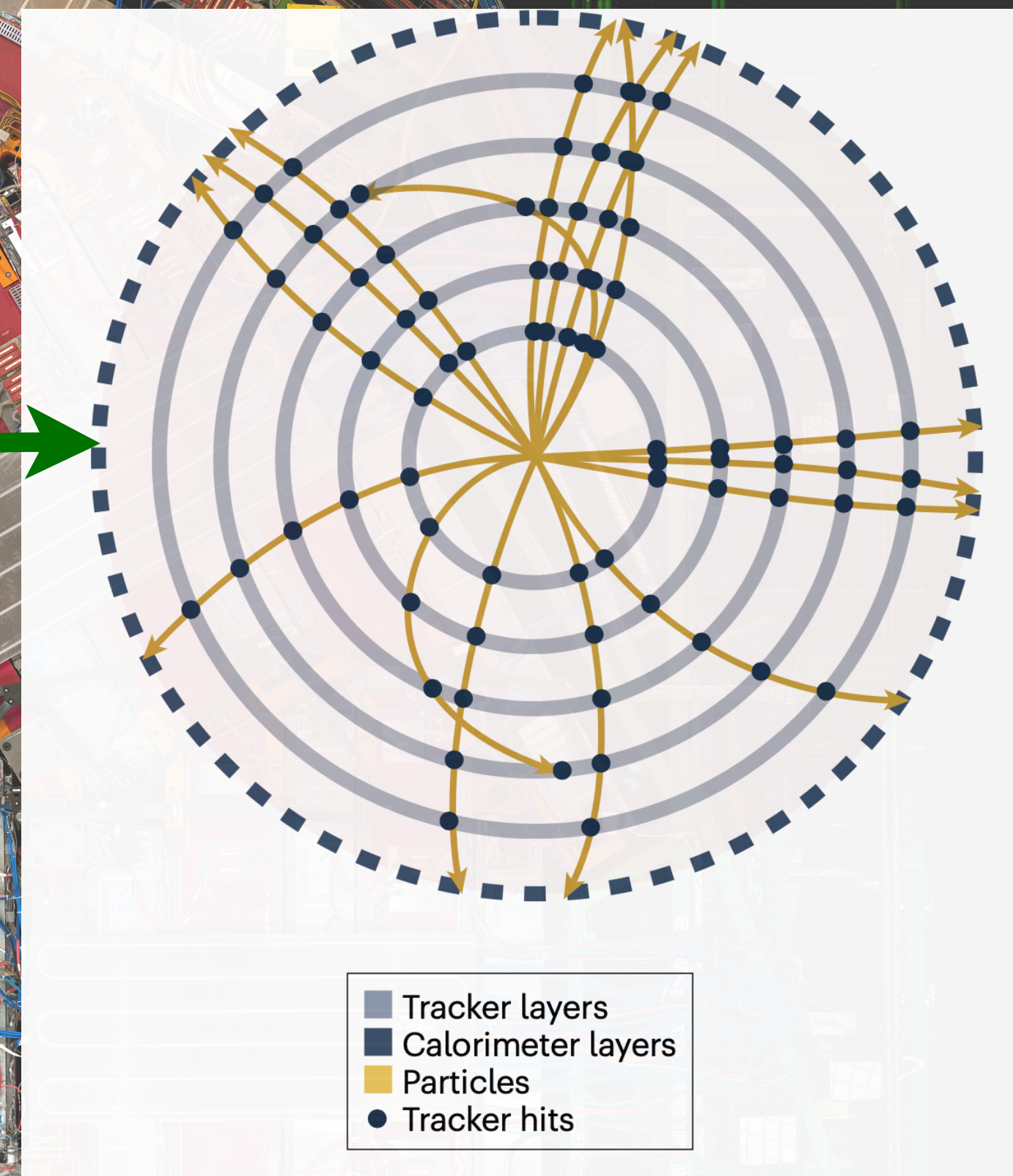

Muon momentum calibration: overview

- Momentum measured from track curvature (using tracker only)
 - ~17 hits per track: single-hit resolution of 9-50 μm
 - \Rightarrow Sagitta $\sim 6 \text{ mm}$, $\delta p_{\text{T}}^{\ell} \sim 10^{-4} \Rightarrow \delta S \sim 0.6 \mu\text{m}$

Sagitta (S) \leftarrow

$$p_{\text{T}} = qBR = qBL^2/8S$$

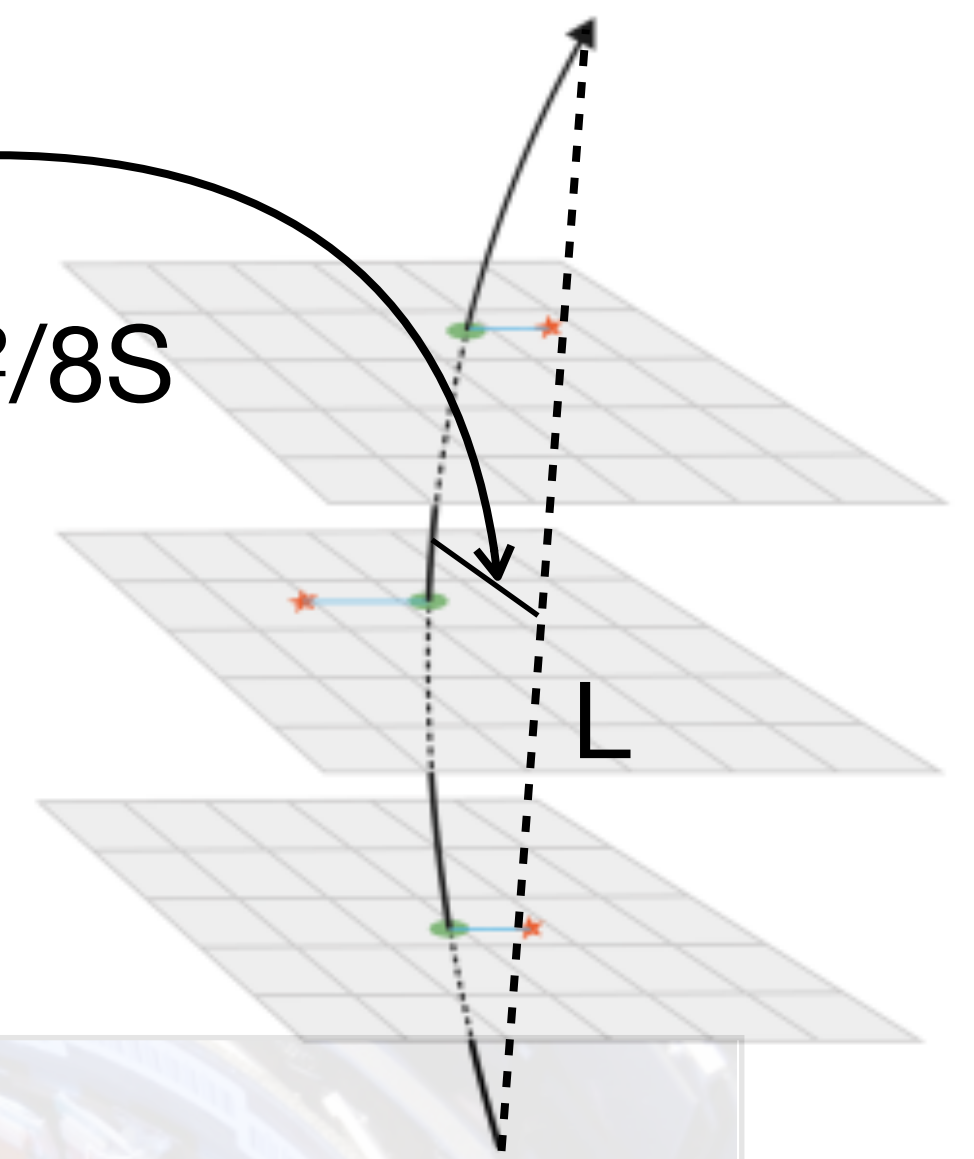

\rightarrow Precisely control sources that impact particle propagation and track measurement

- Magnetic field throughout volume
- Relative alignment of different tracker modules
- Material and particle material interaction

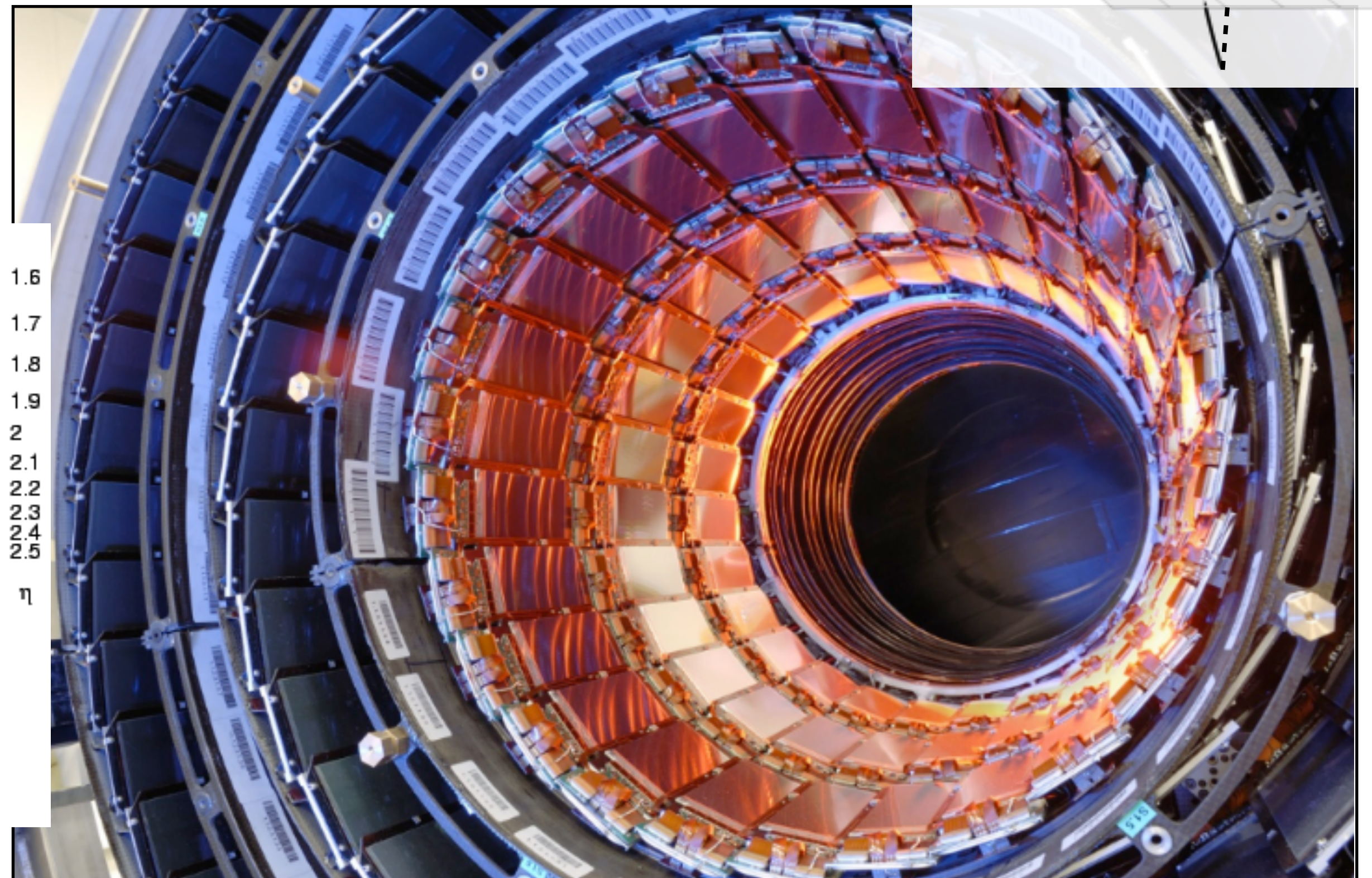
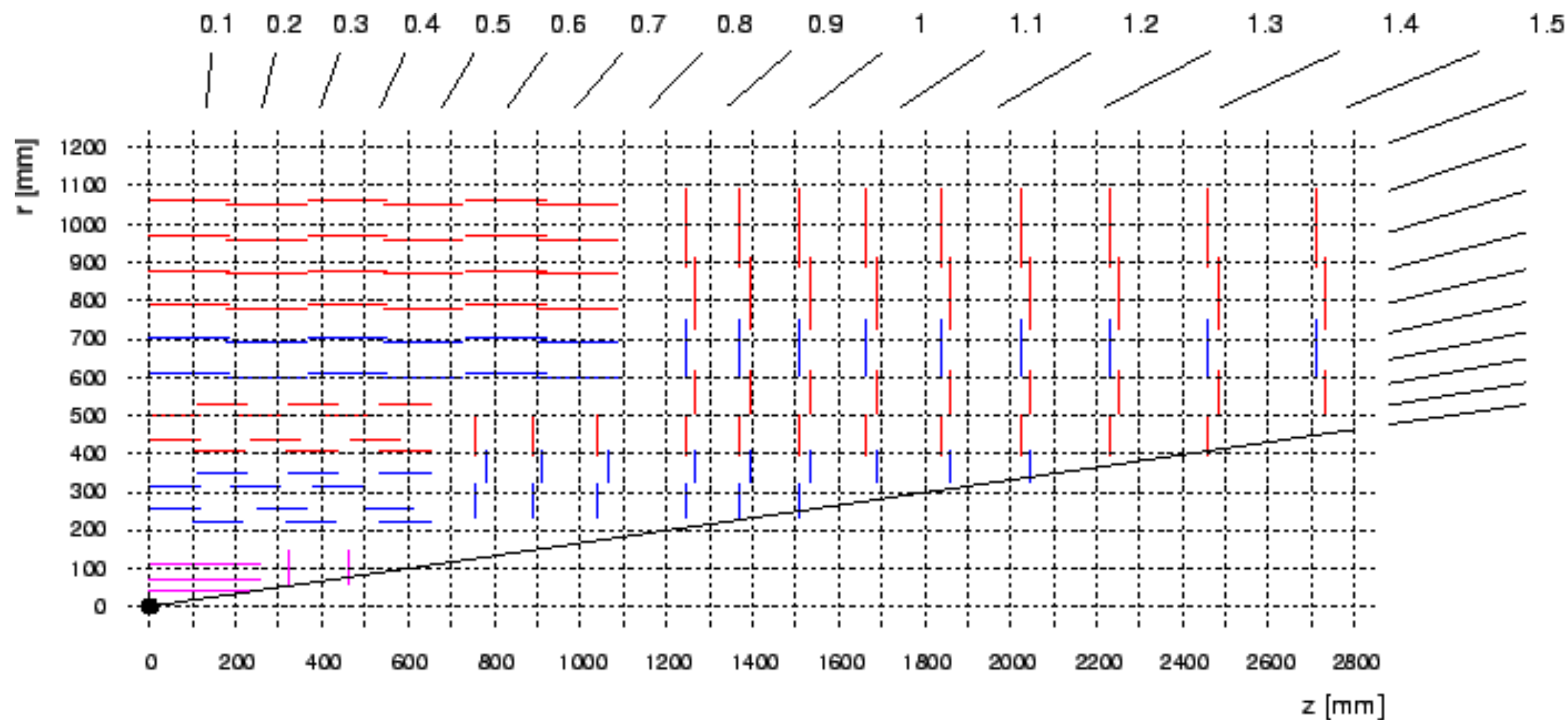

Muon momentum calibration: Magnetic field

- CMS magnetic field was precisely mapped before being inserted into the detector
 - Differences from precise mapping+simulation of ~ 0.003 T offset is ~ 100 MeV bias in m_W

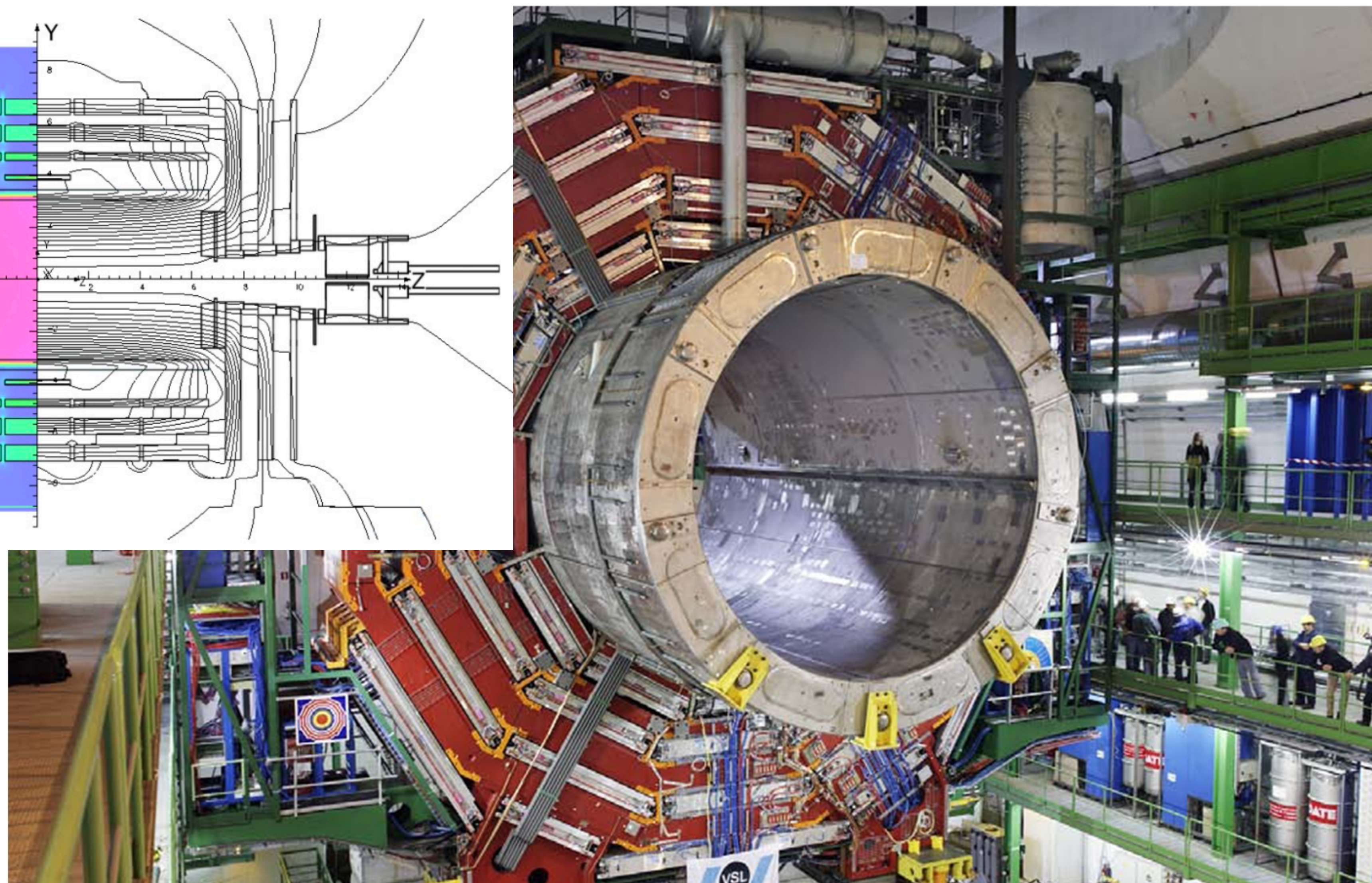
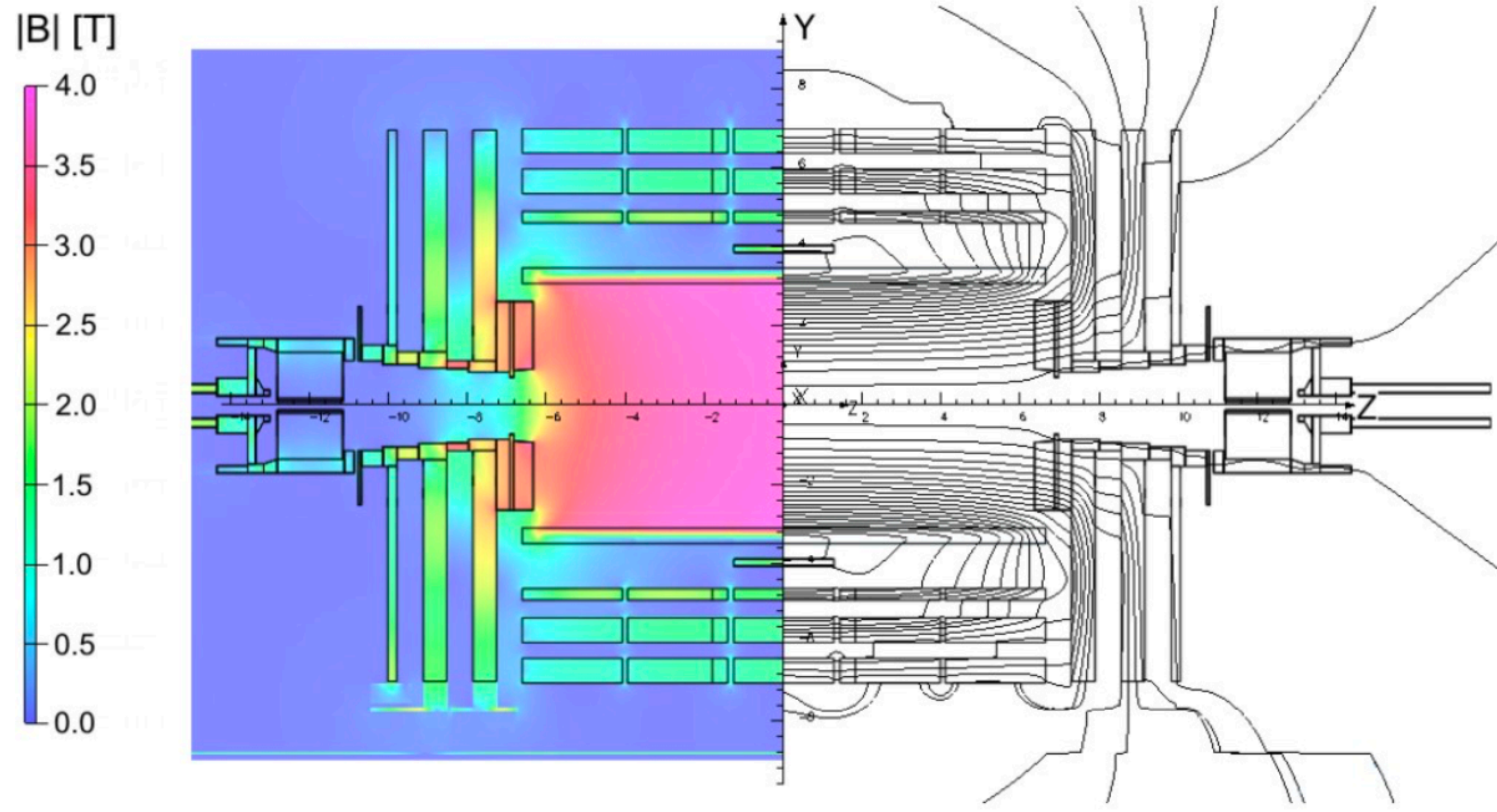

Muon momentum calibration: Alignment and material loss

- Knowing location and quantity of material, and relative alignment of 12k tracker modules also crucial
 - Need to know material traversed — not just silicon, but electronics, cables, support structure...
 - ➔ 5 MeV of bias equivalent to $\sim \Delta 5$ mm of iron in the tracker volume
 - Relative shifts from gravity, opening of the detector, modify alignment
 - ➔ 5 MeV uncertainty is a ~ 0.4 μm misalignment

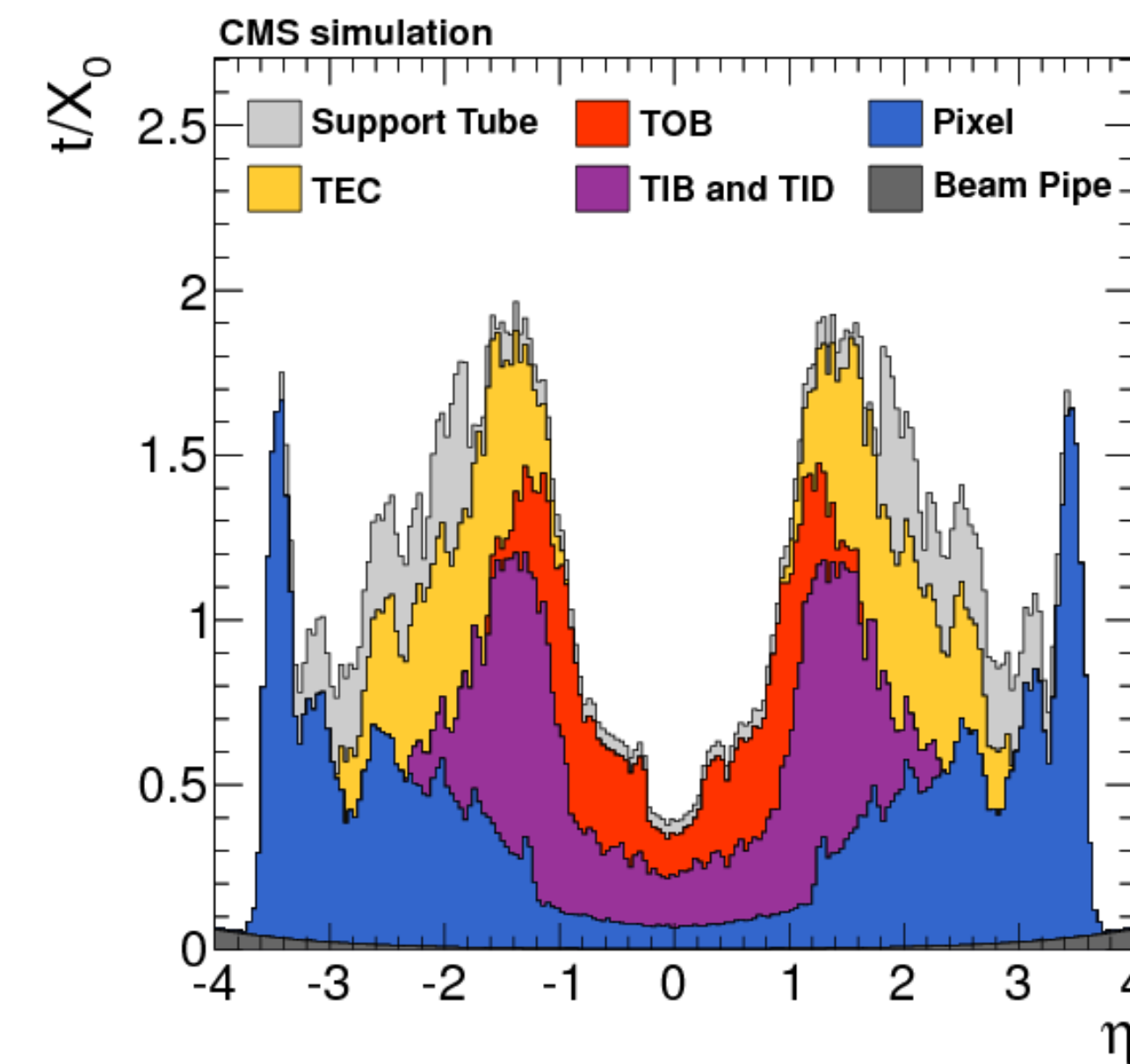
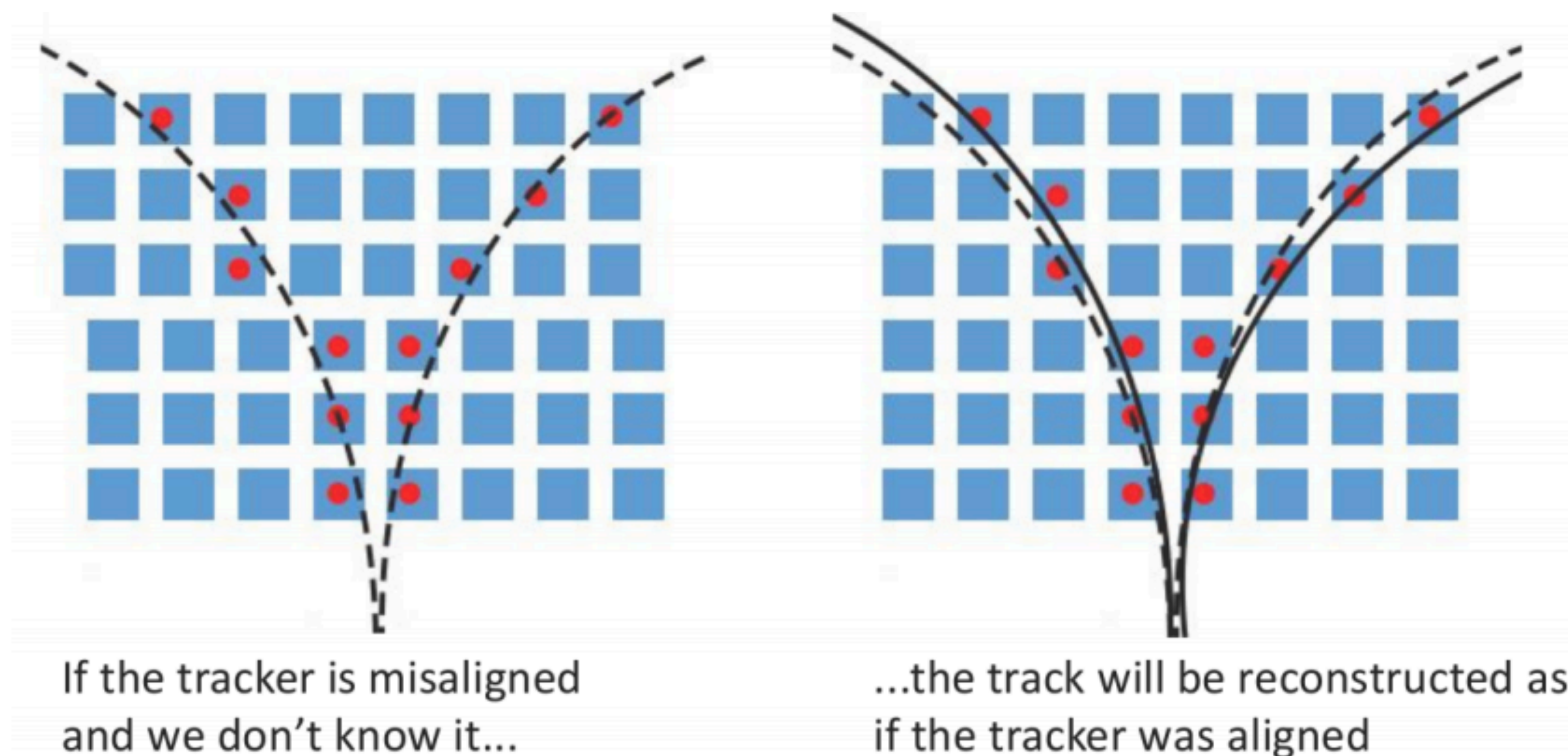
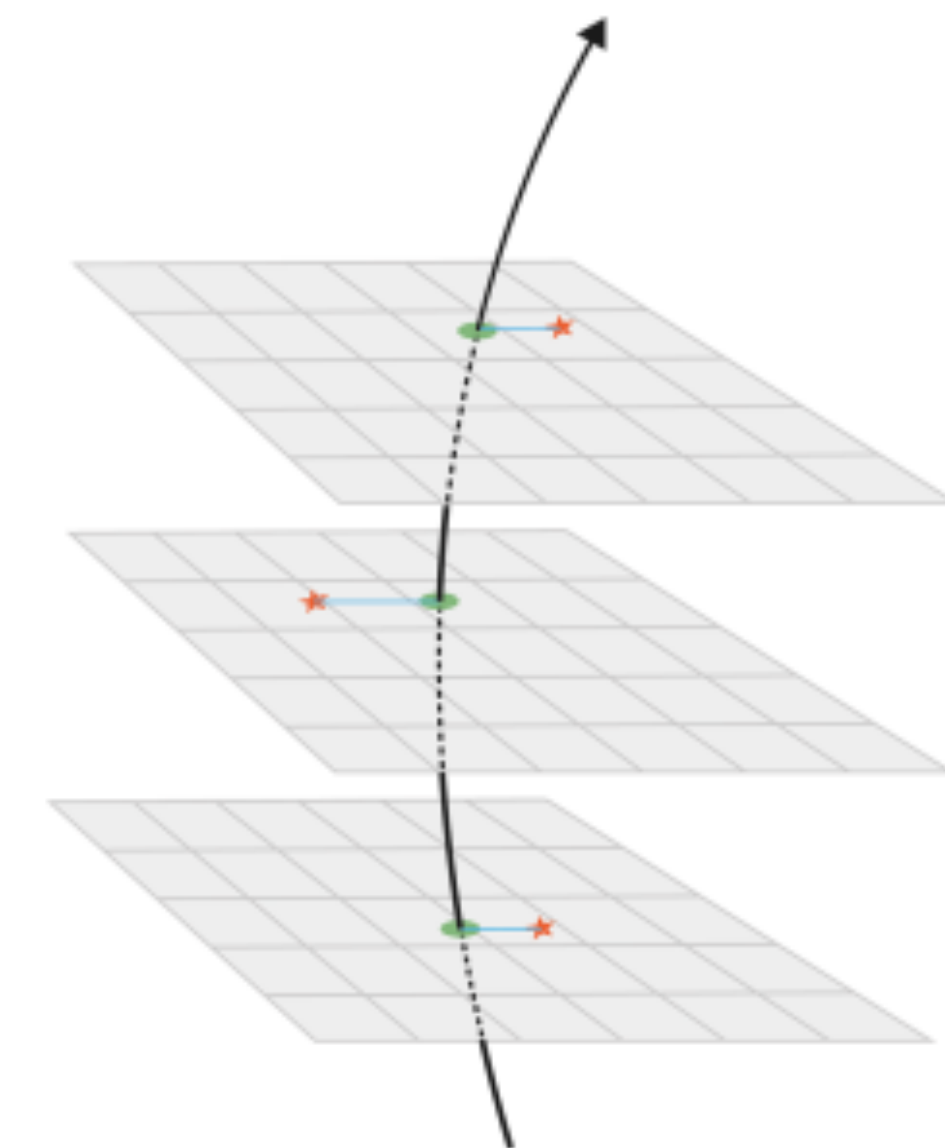

- ★ Calibrate in data using a known reference: J/ψ
 - Used to pin down sources of bias/uncertainty
- ➔ Need robust parameterisation for extrapolation across p_T
 - $k \equiv 1/p_T$ (curvature)
 - **A: magnetic field correction**
 - **M: alignment correction**
 - **e: energy loss correction (e.g., material budget)**

$$k_{corr} = Ak + qM + \frac{k}{1 + ek}$$

$$\delta k/k \approx \underline{A} + \underline{qM}/k - \underline{ek}$$

- Multi-step procedure
 1. Improved, custom refit of track to muon hits
 2. Apply module-by-module corrections from track refit
 3. Derive parameterised corrections (binned in η_μ) from fit to J/ψ resonance
- ➔ Validate J/ψ -based calibration with $Y(1S)$ and Z

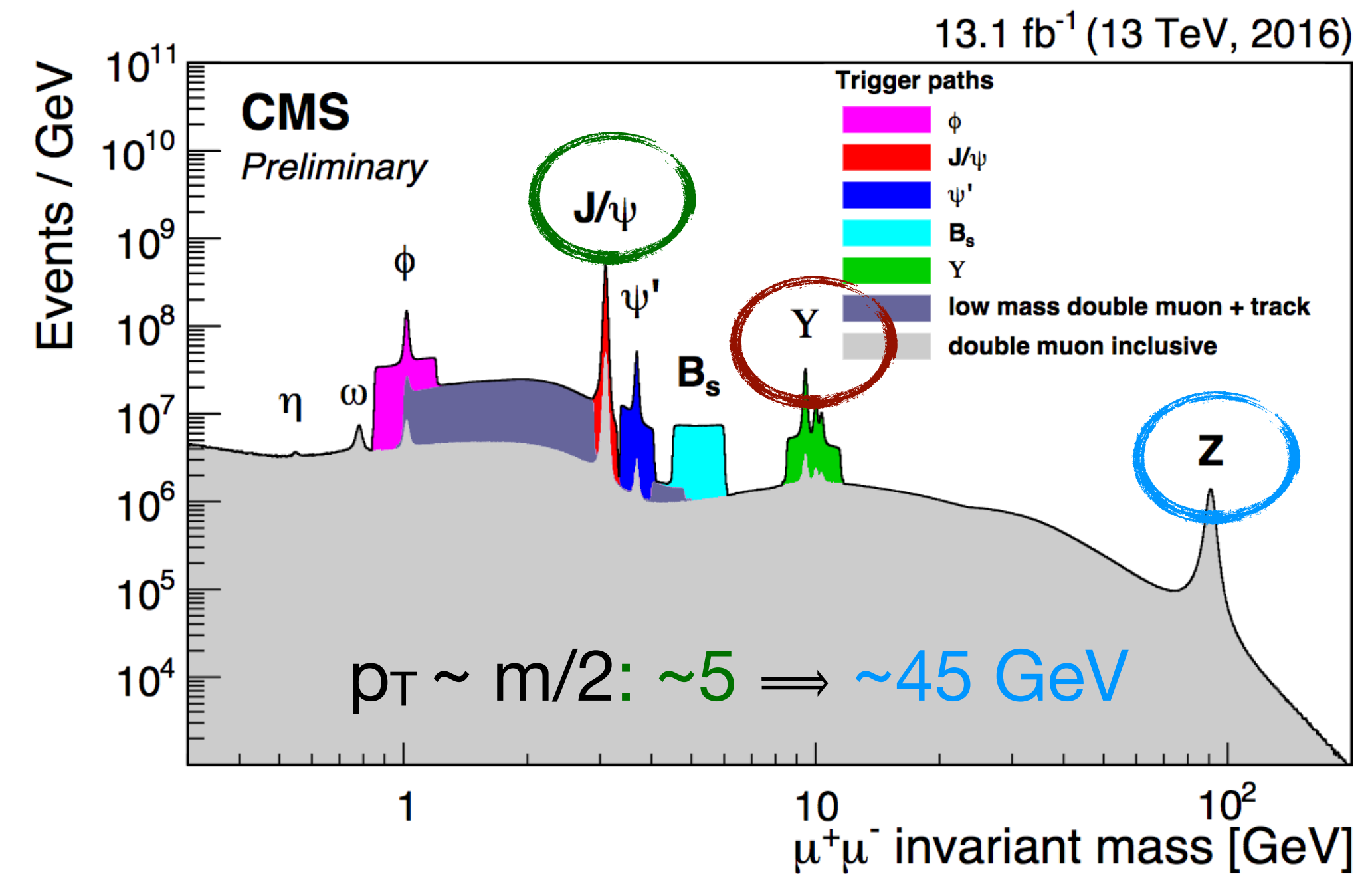

- Corrections for muon momentum resolution derived from binned (in η_μ) fits to Z events

Muon momentum scale calibration: custom track fit

- Refit muon hits using custom “Continuous Variable Helix” fit
 - Model material in helix fit with Geant4+additional params for B-field
 - Increase Geant precision wrt standard CMS reco.
 - Use of high-precision B-field map (lower speed wrt standard reco.)
- ➔ Extract and apply per-module parameter corrections

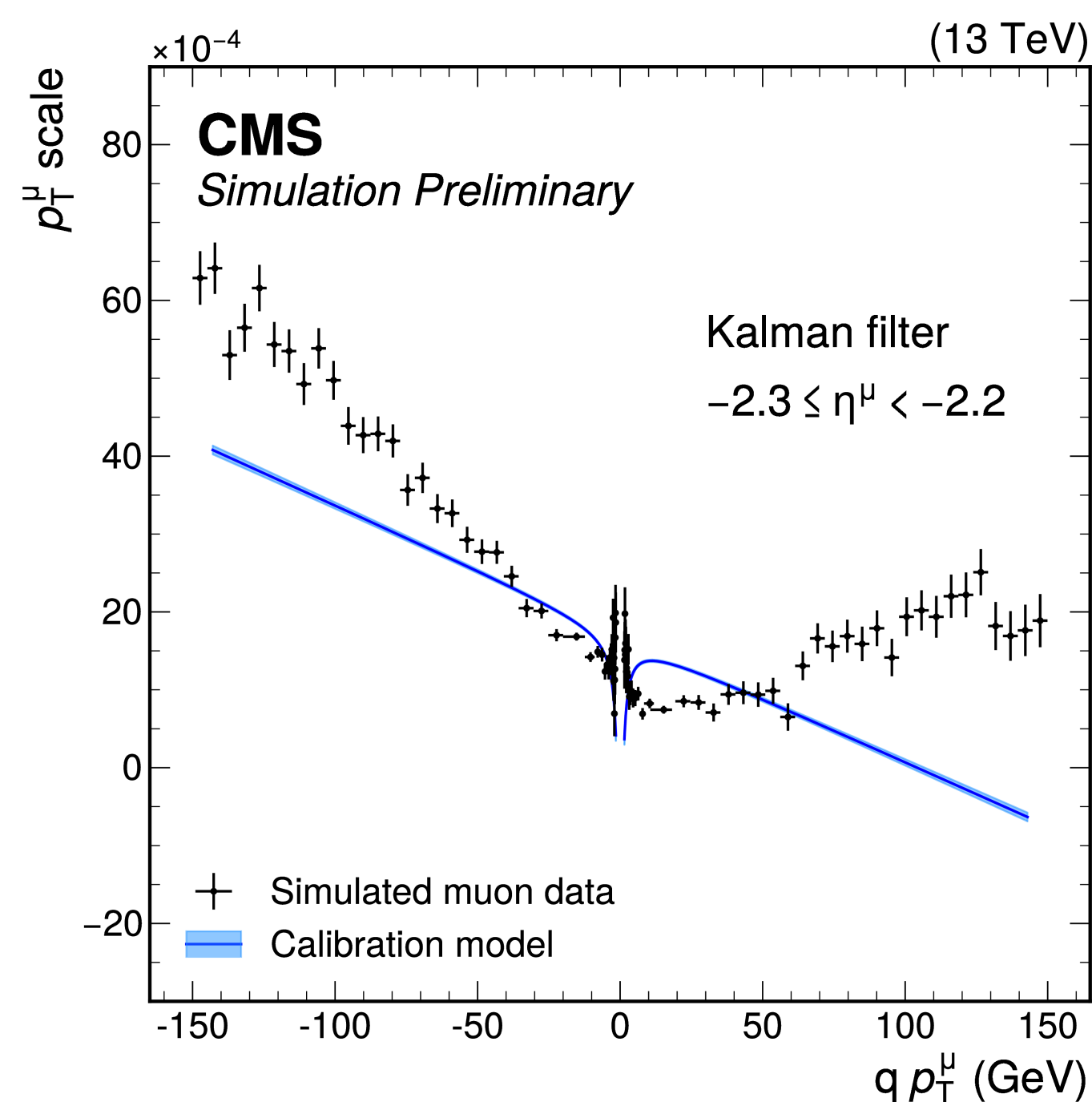
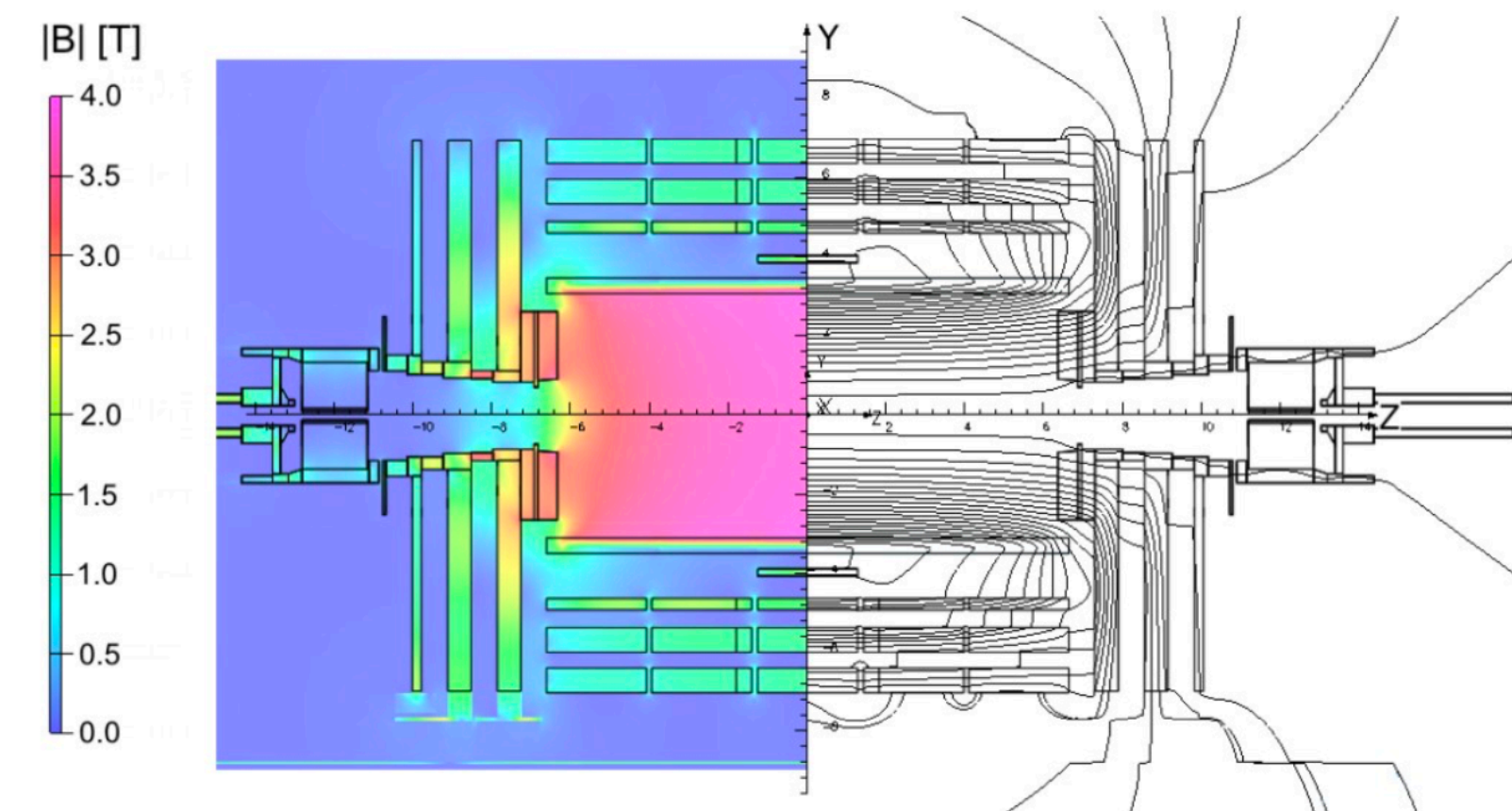

CMS standard reco.

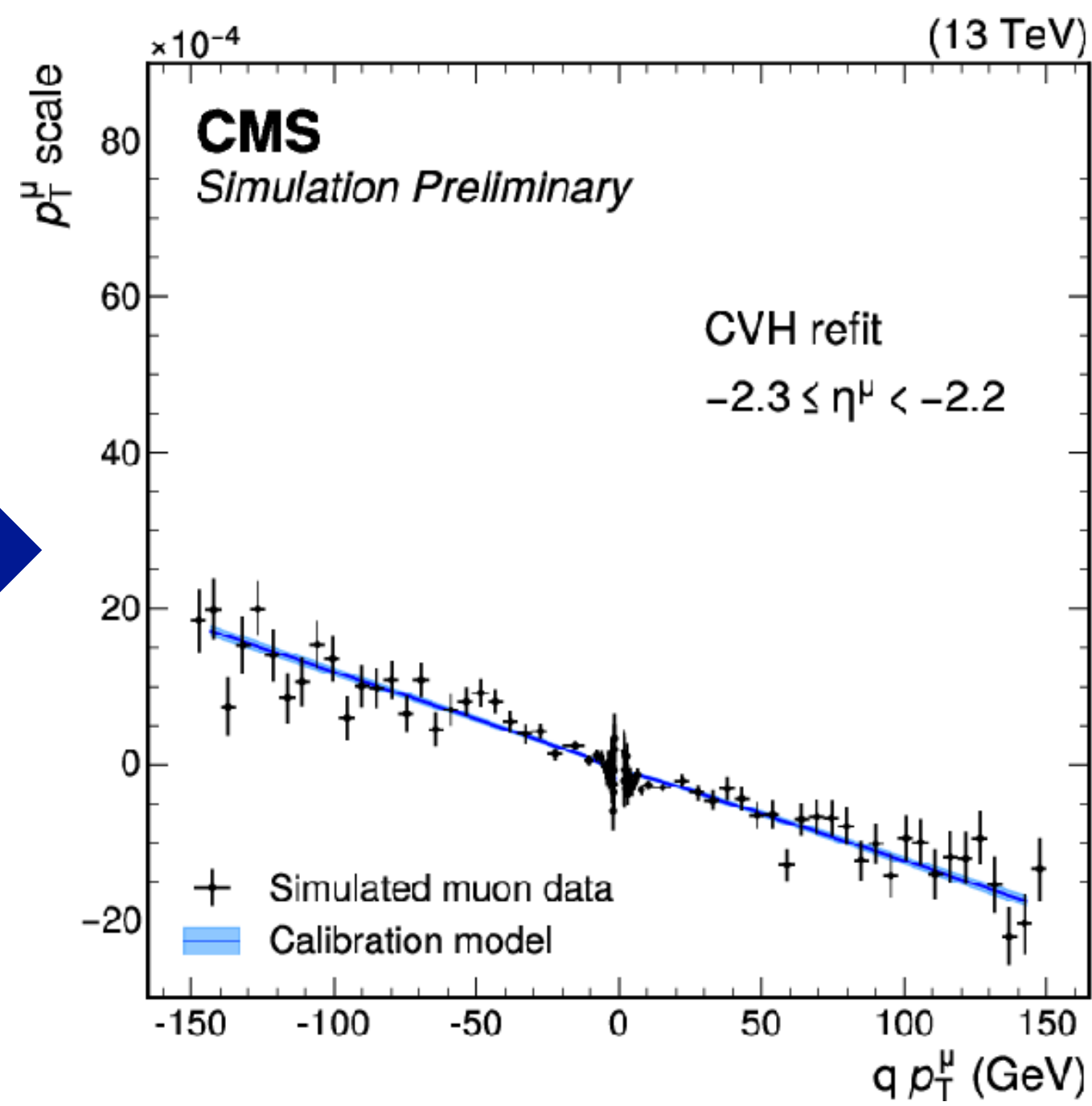

CVH refit

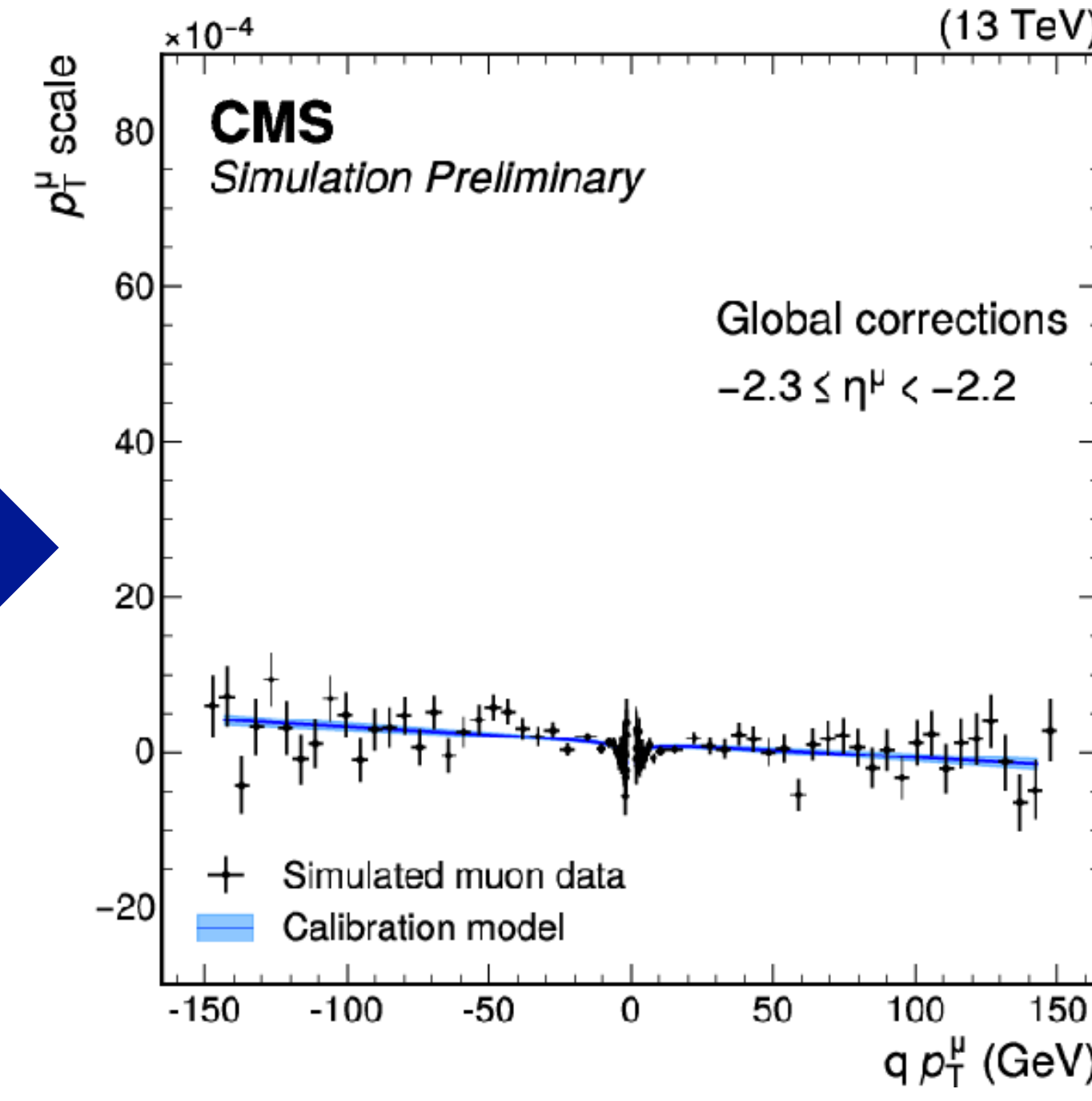

CVH refit+corr.

- Parameter extraction procedure

1. Fit J/ψ mass in a binned 4D space of $(p_{T\mu^+}, p_{T\mu^-}, \eta^{\mu^+}, \eta^{\mu^-})$
2. Using χ^2 minimization, extract η -binned calibration parameters per muon
3. Closure test: perform same procedure on $Y(1S)$ and Z to assess consistency

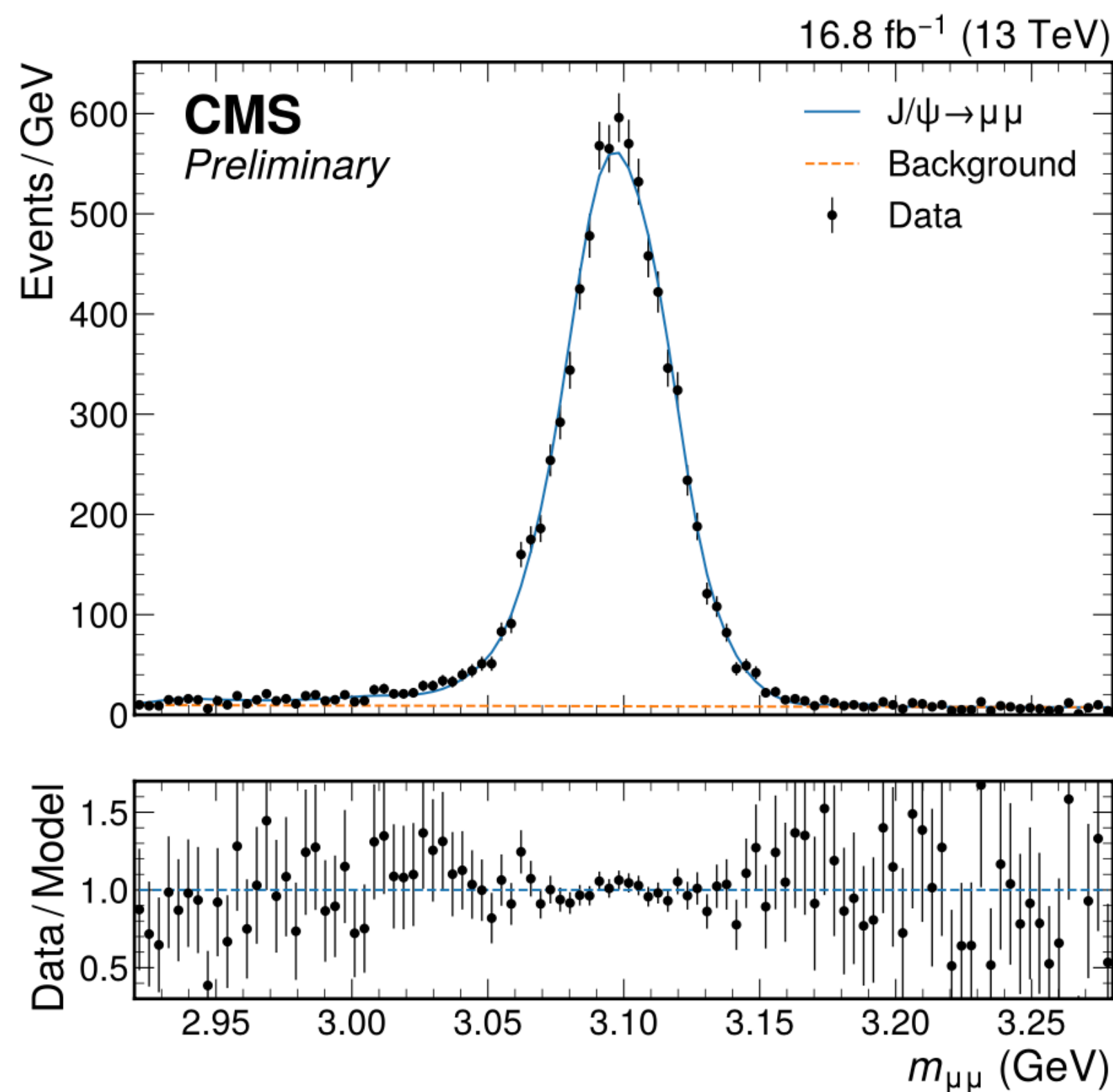

$$\delta k/k \approx \underbrace{A}_{\text{red}} + \underbrace{qM/k}_{\text{blue}} - \underbrace{ek}_{\text{green}}$$

Left: example fit to J/ψ in central η bin

Right: Extracted parameters per η bin, (on top of module-level corrs.)

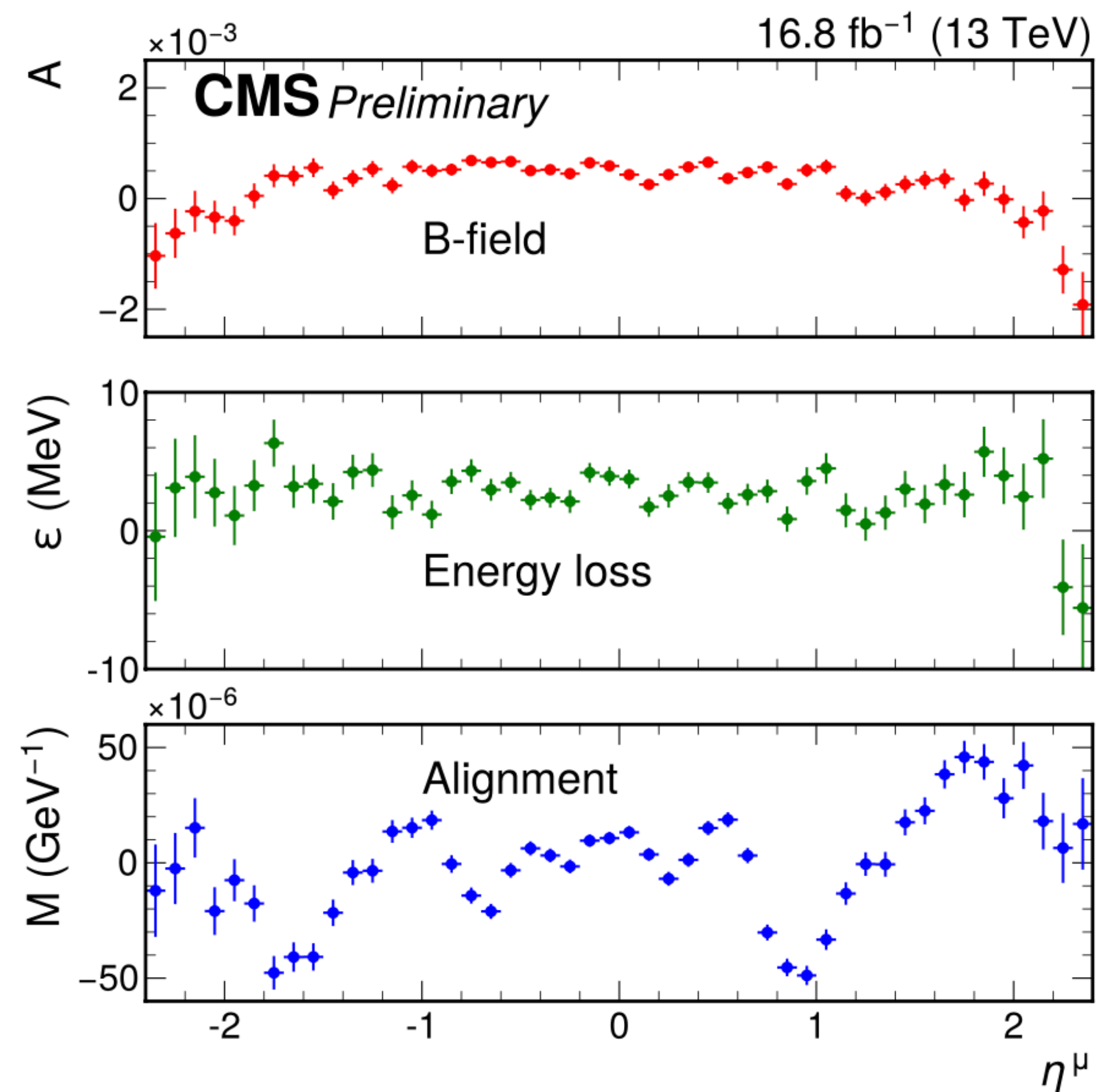

- Closure tests: apply mass-fit procedure to Y(1S) and Z
 1. Correct by binned (A, e, M) parameters from J/ψ
 2. Fit for residual correction to parameters
- Stat. unc. in parameters from J/ψ used as basis for systematic unc.
 - Scaled up by 2.1 for full coverage
 - Confirmed Y- and Z-based calibrations are within unc. before unblinding

➔ Uncertainty in m_W 4.8 MeV

Source of uncertainty	Nuisance parameters	Uncertainty in m_W (MeV)
J/ψ calibration stat. (scaled $\times 2.1$)	144	3.7
Z closure stat.	48	1.0
Z closure (LEP measurement)	1	1.7
Resolution stat. (scaled $\times 10$)	72	1.4
Pixel multiplicity	49	0.7
Total	314	4.8

ATLAS: calibration on Z (~7 MeV unc.)

CDF: Combination of J/ψ, Y, and Z (3 MeV unc.)

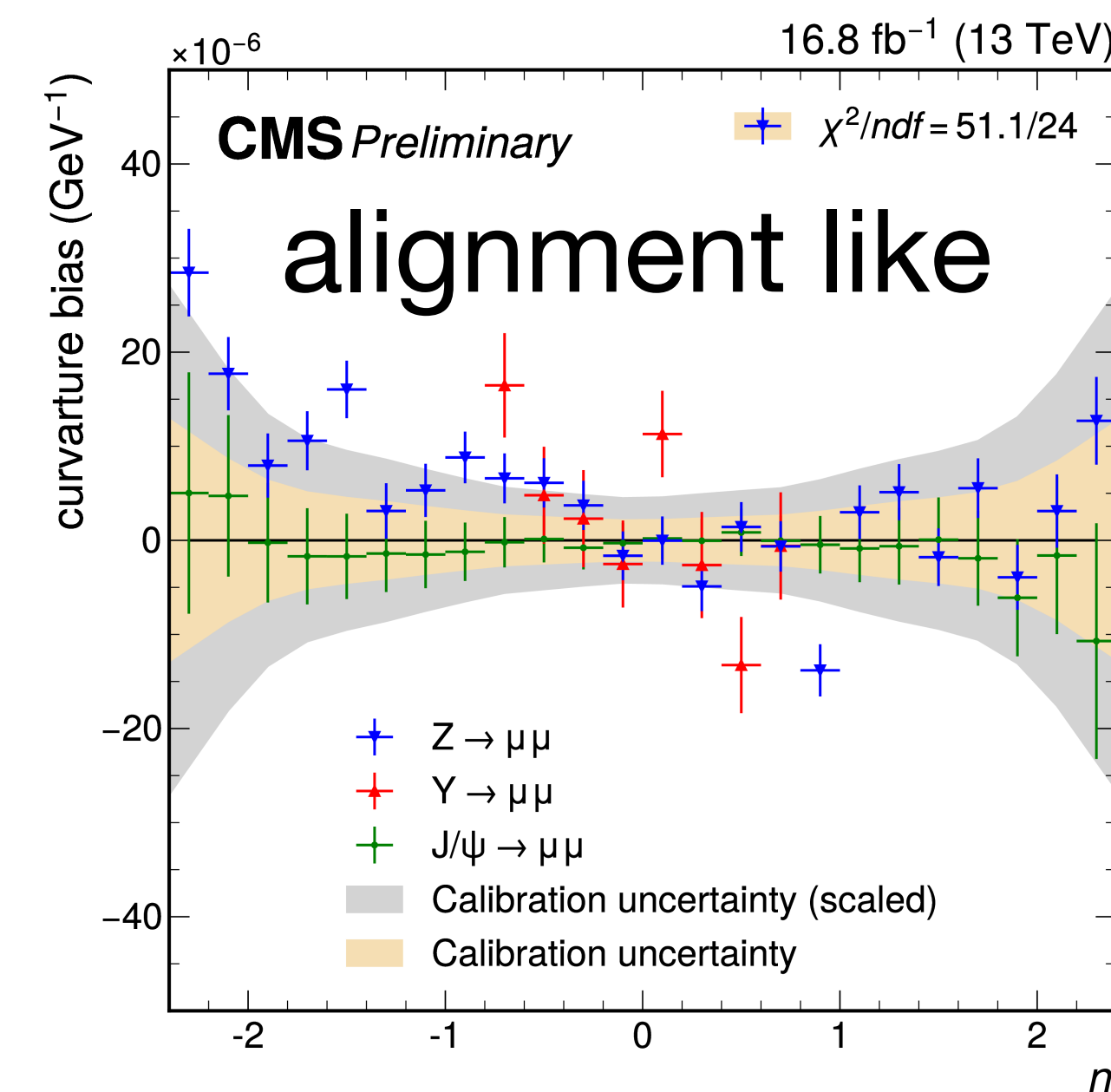
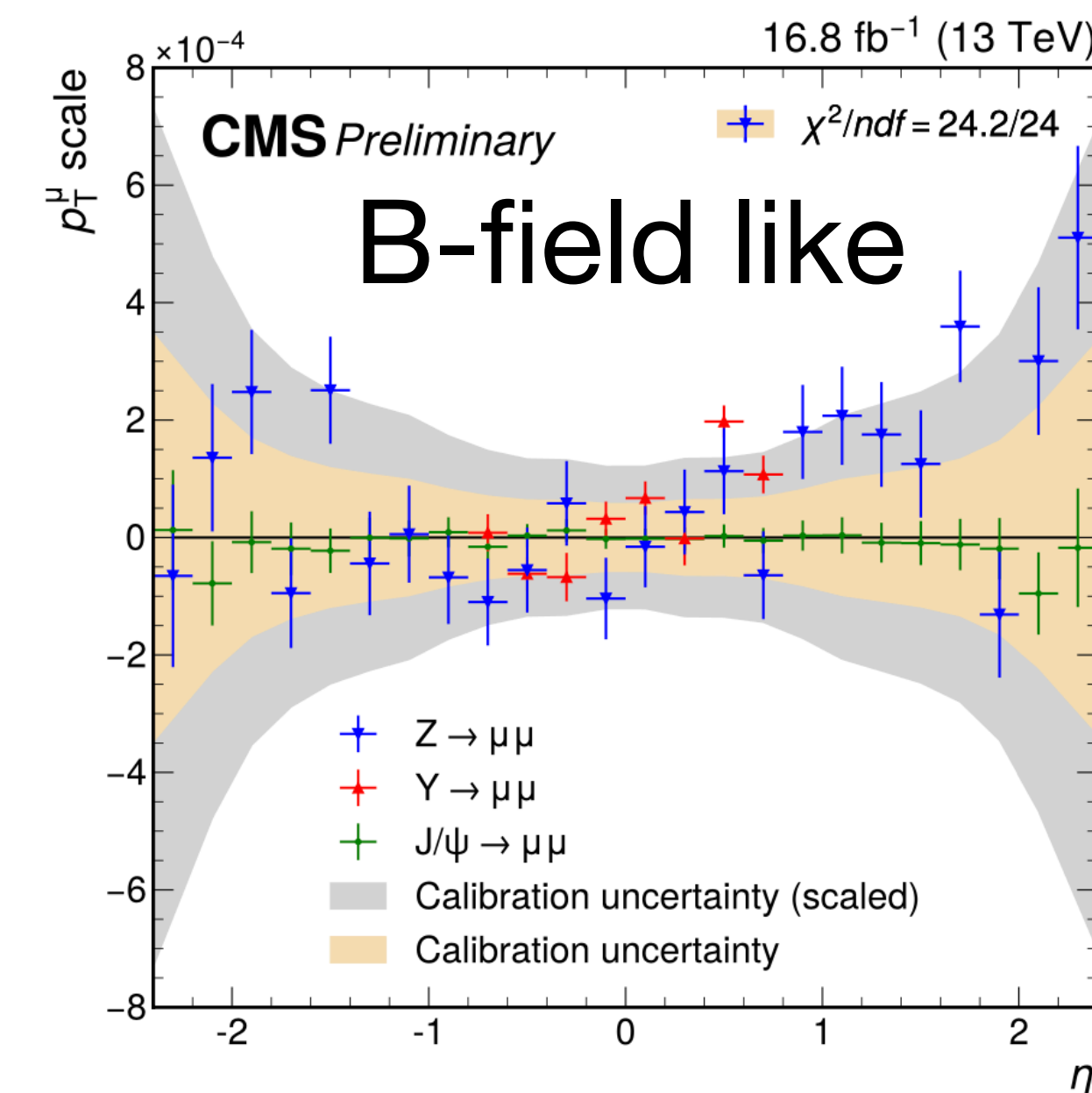

★ Extracting m_Z from fit to $m_{\mu\mu}$

- Extract m_Z from binned likelihood fit to $m_{\mu\mu}$ in bins of signed η^μ of most forward muon
 - Validate experimental techniques

$$m_Z - m_Z^{\text{PDG}} = -2.2 \pm 4.8 \text{ MeV} = -2.2 \pm 1.0 \text{ (stat)} \pm 4.7 \text{ (syst) MeV}$$

- Not (yet) an independent measurement of m_Z
- Stability of result (calibration) validated across η^μ

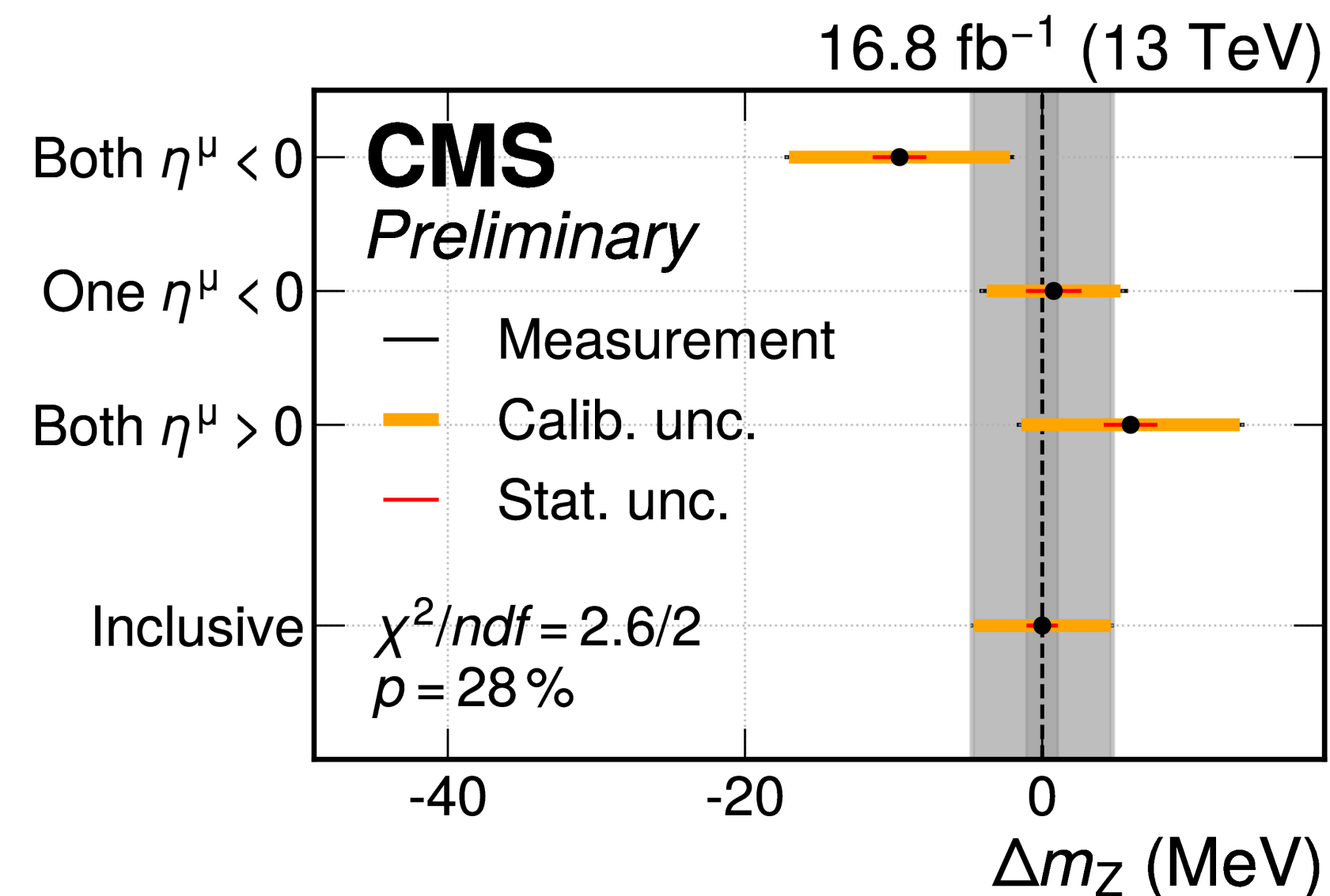
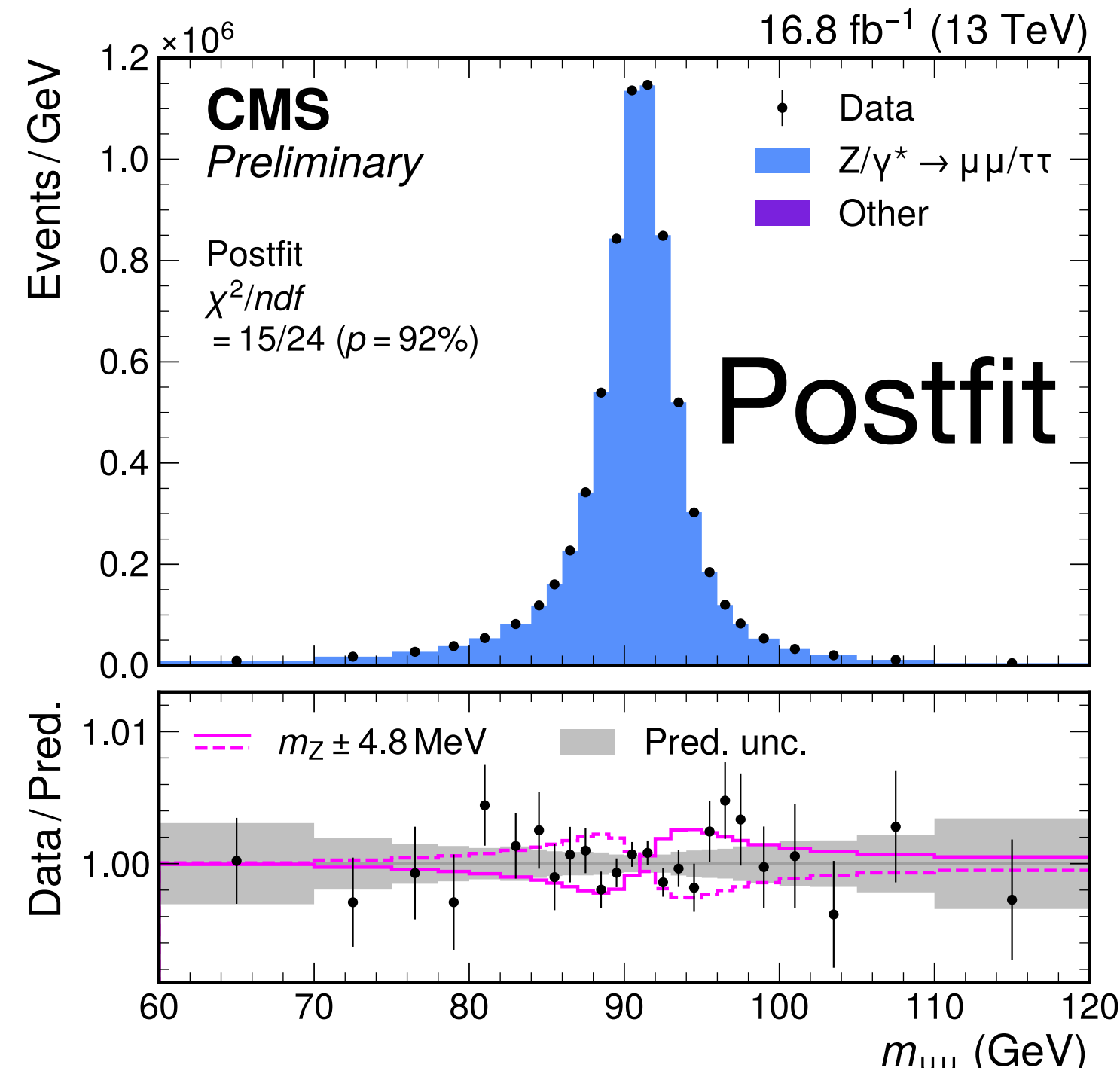
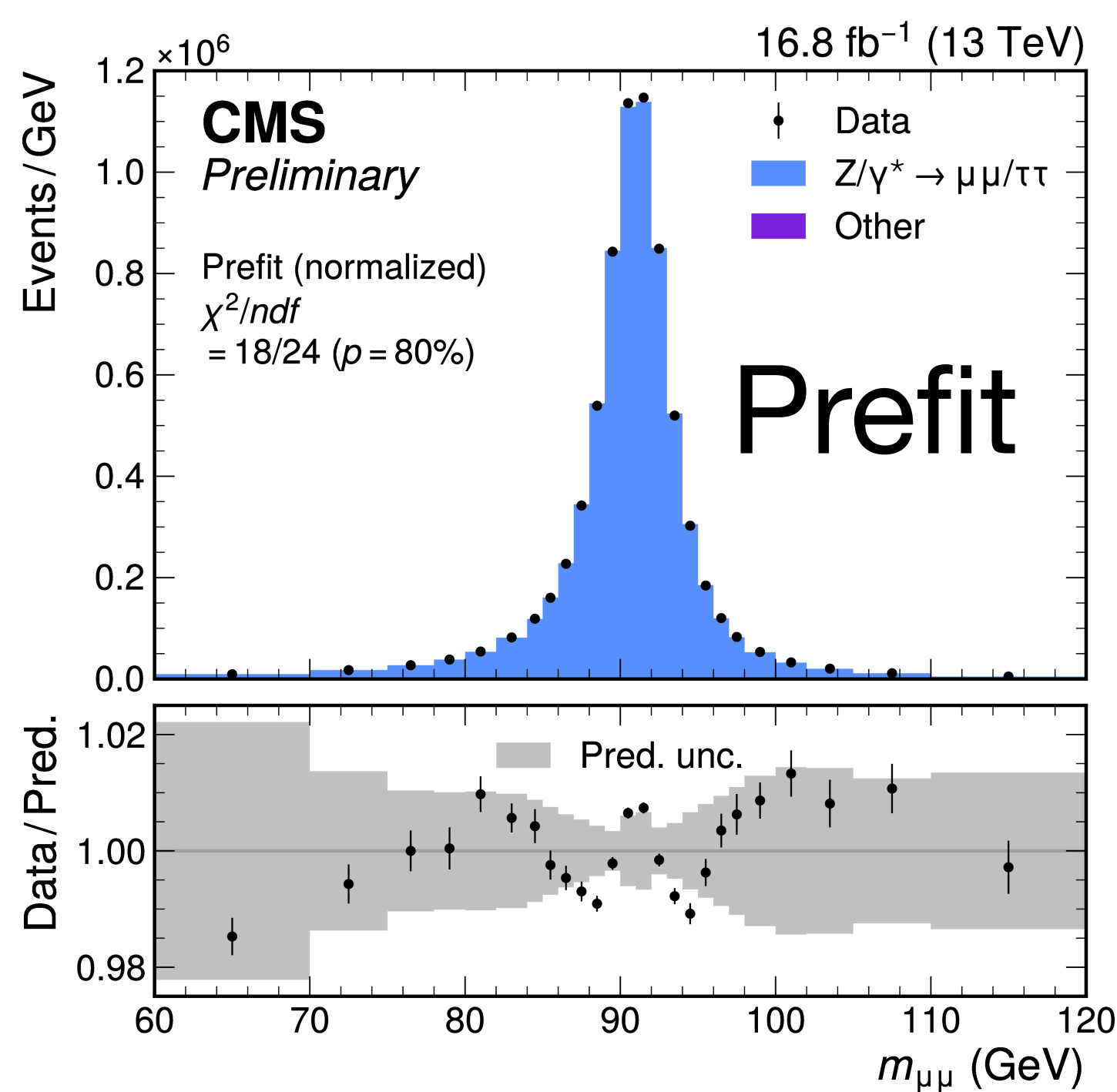

W and Z boson production at the LHC

- Measurement requires percent-level control of predictions
- **Complex calculations with many sources of uncertainty**

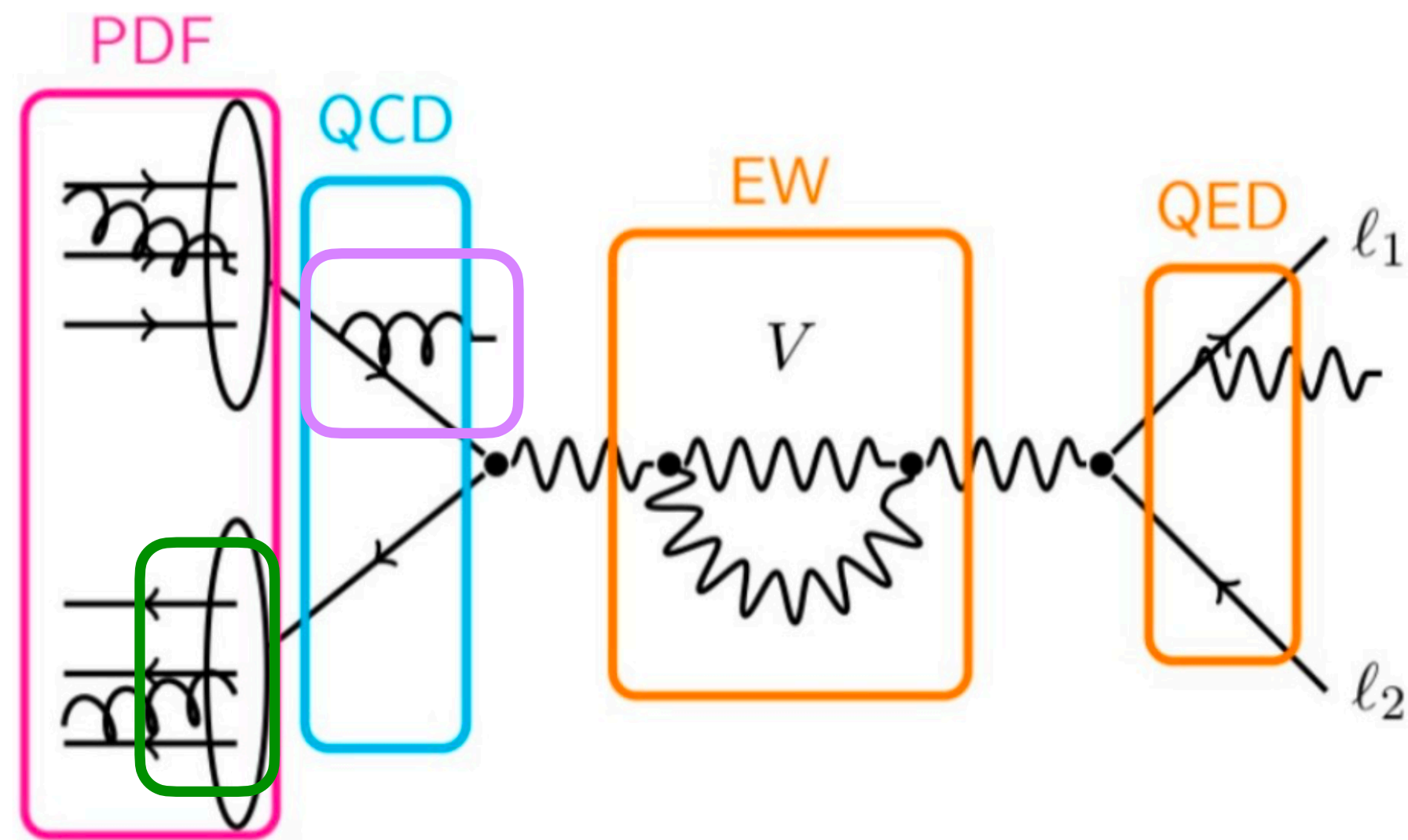

- PDF determines quark flavour and momentum
- Non-perturbative motion of quarks important at low p_T^V
- Resum soft gluons for low/intermediate region
- pQCD accurate at high p_T^V
- **Electroweak corrections** small, but relevant

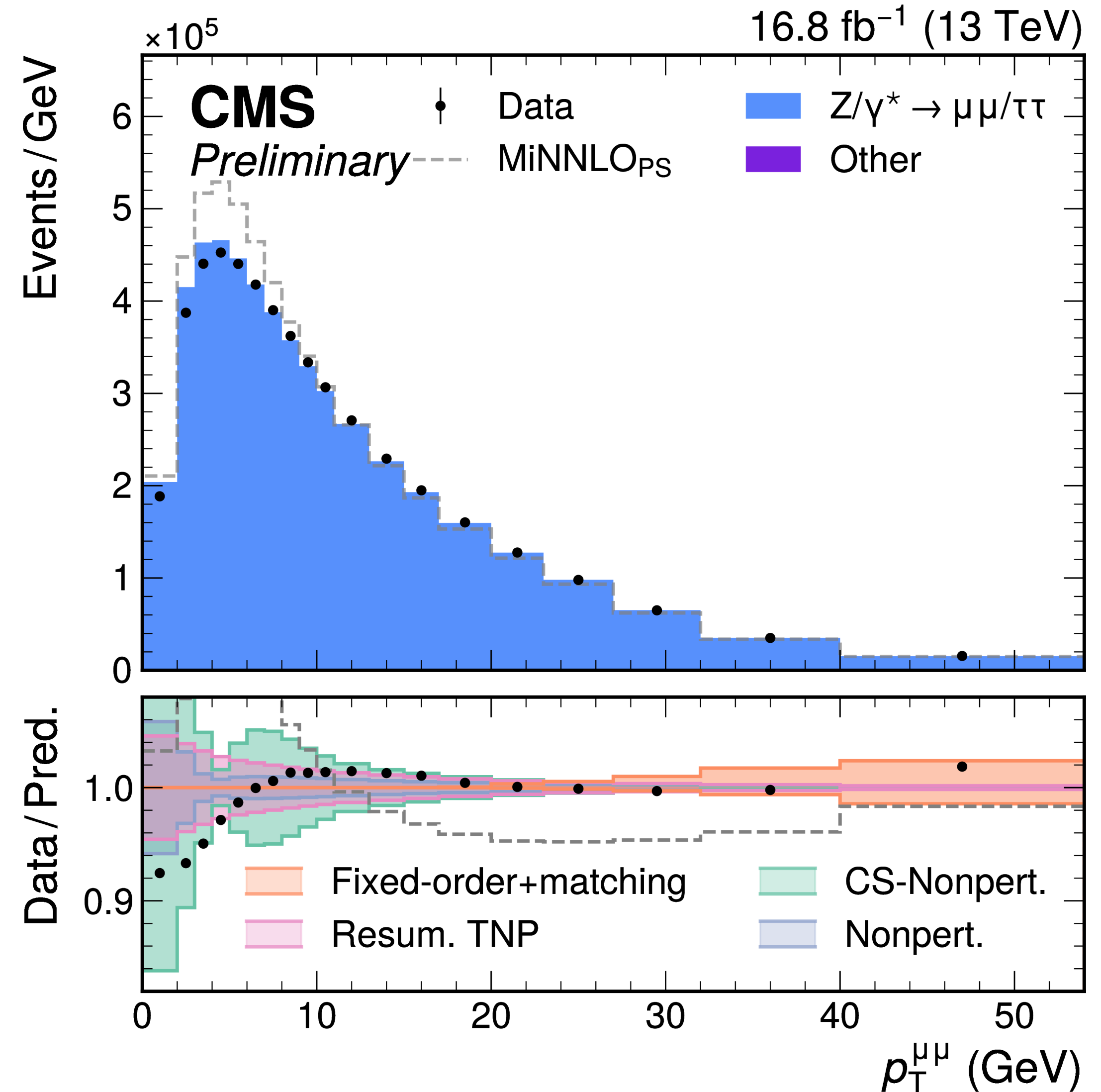

p_T^V modeling and uncertainties: overview

- Huge Monte Carlo samples with full detector simulation (4 B events) from MiNNLO_{PS}+Pythia+Photos
 - Low- p_T^V dominated by non-perturbative effects, radiation of soft gluons (modelled by Pythia)
 - Improved accuracy from high-order calculation in resummation theory
 - Apply granular, high-stat. 2D **binned corrections to MiNNLO** from SCETlib ($N^3LL+NNLO$)
- ➔ Z boson used only for validation, not to tune simulation

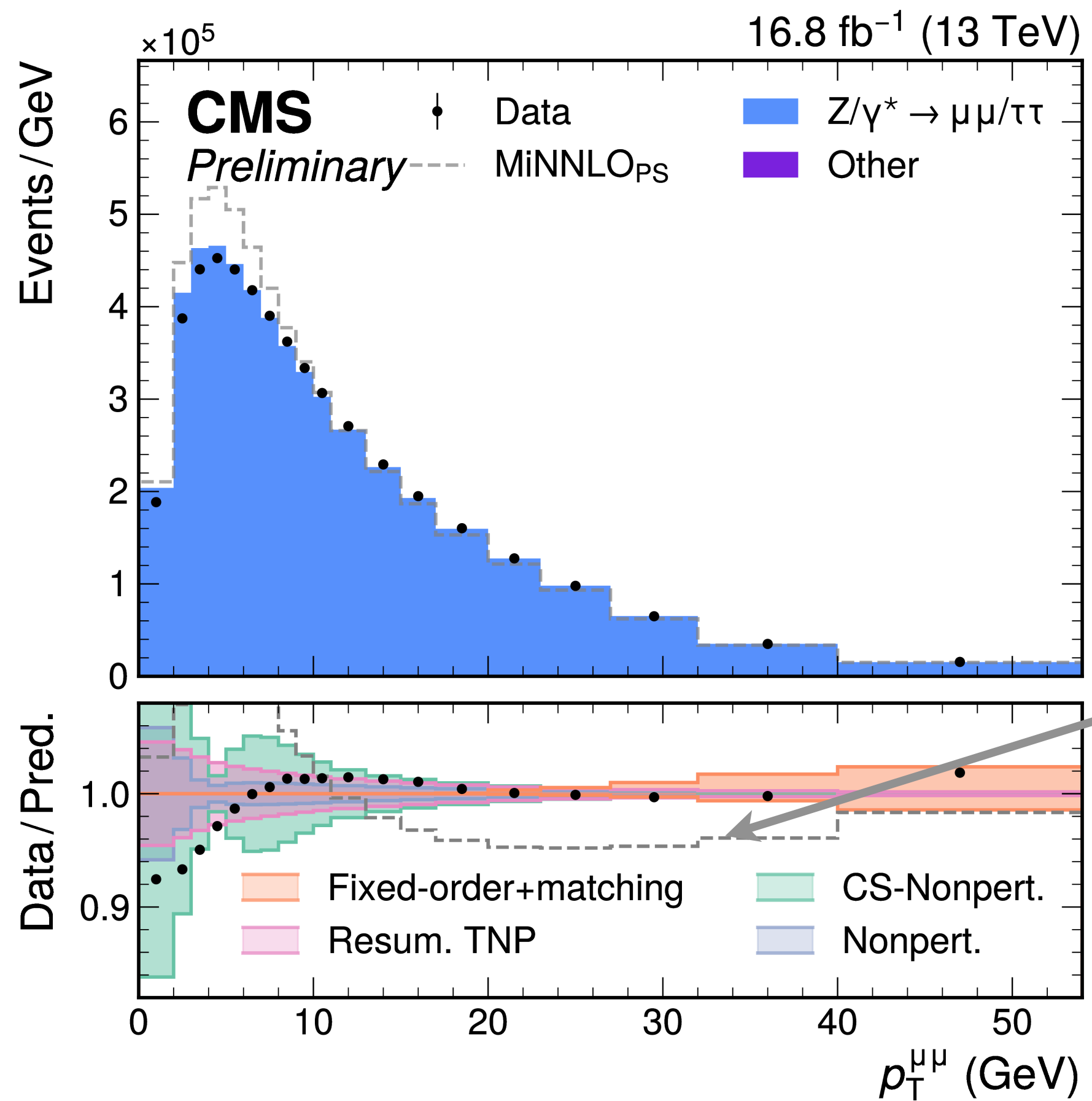

MiNNLO_{PS}+Pythia
Uncorrected

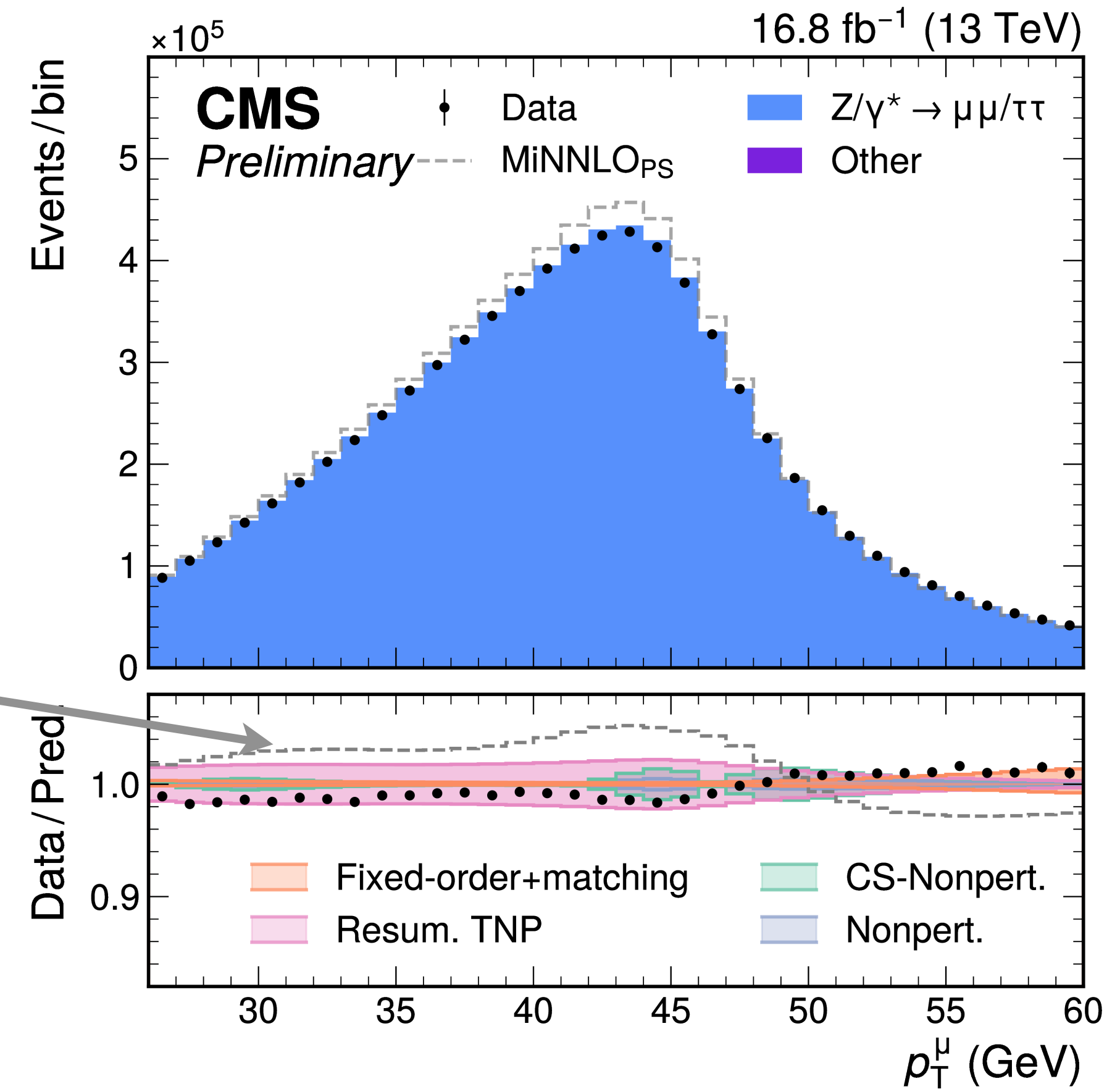

Non-perturbative effects and uncertainty

- PDF assumes parton momentum is entirely aligned with the proton motion
 - Residual motion in the proton: **low energy \Rightarrow nonperturbative (NP)**
- Use **phenomenological NP model in SCETlib** inspired by lattice QCD
 - Params untuned, loosely constrained, extracted separately for W and Z
 - Constrained by data: **~ 1.5 MeV unc. in m_W**

$$\tilde{\sigma}^{\text{np}}(Y) = [1 + \bar{\Lambda}^{(2)}(Y) b_T^2]^2 \exp(-2\Lambda^{(4)} b_T^4),$$

$$\bar{\Lambda}^{(2)}(Y) = \bar{\Lambda}^{(2)} + Y^2 \Delta\bar{\Lambda}^{(2)}.$$

[arxiv:2201.07237](https://arxiv.org/abs/2201.07237)

y-dependence as proxy for
x and flavour dependence

- **Collins-Soper (CS) kernel** universal
(correlated for W and Z)
- **Others (Gaussian intrinsic momentum)**
not correlated

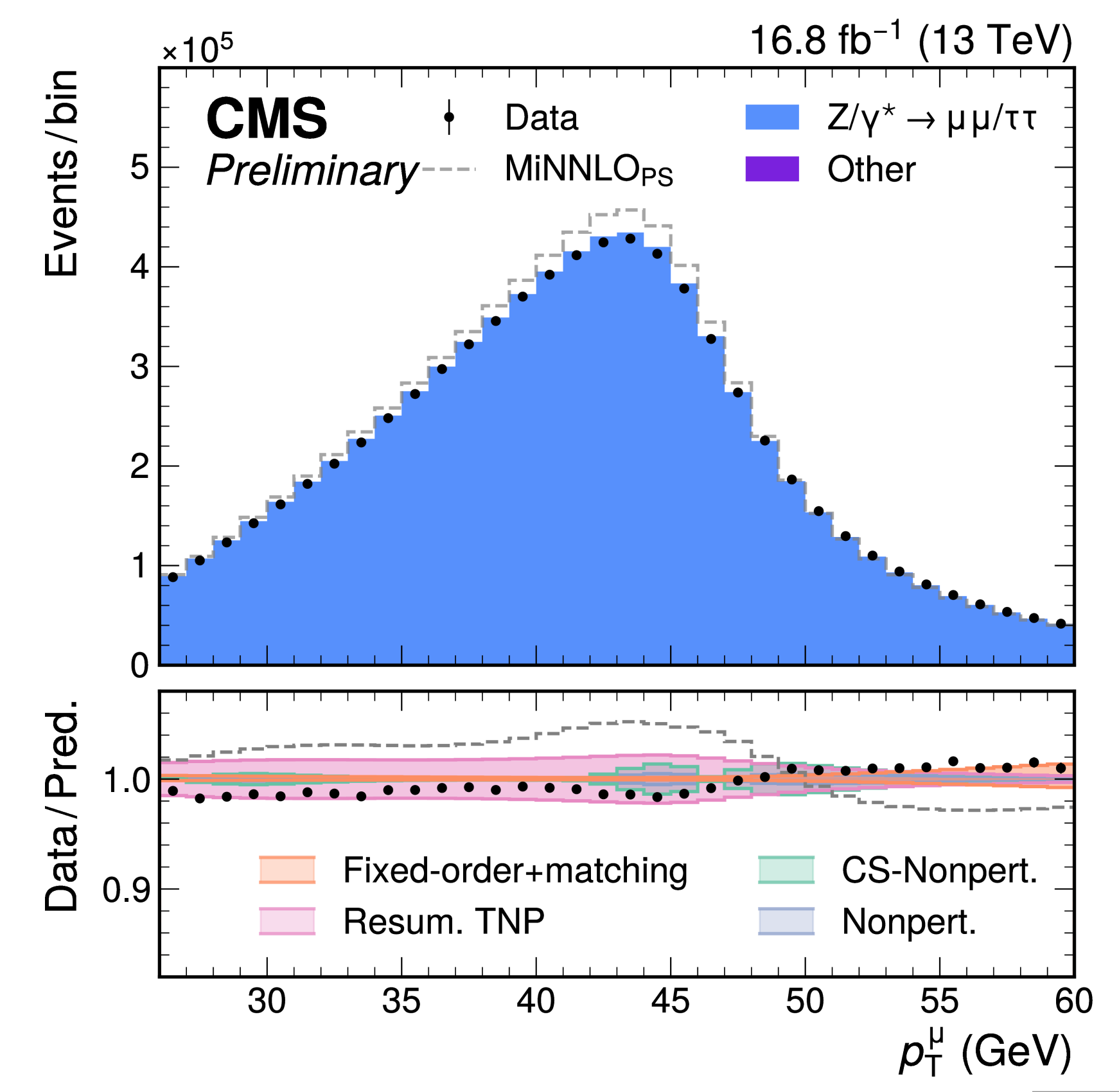
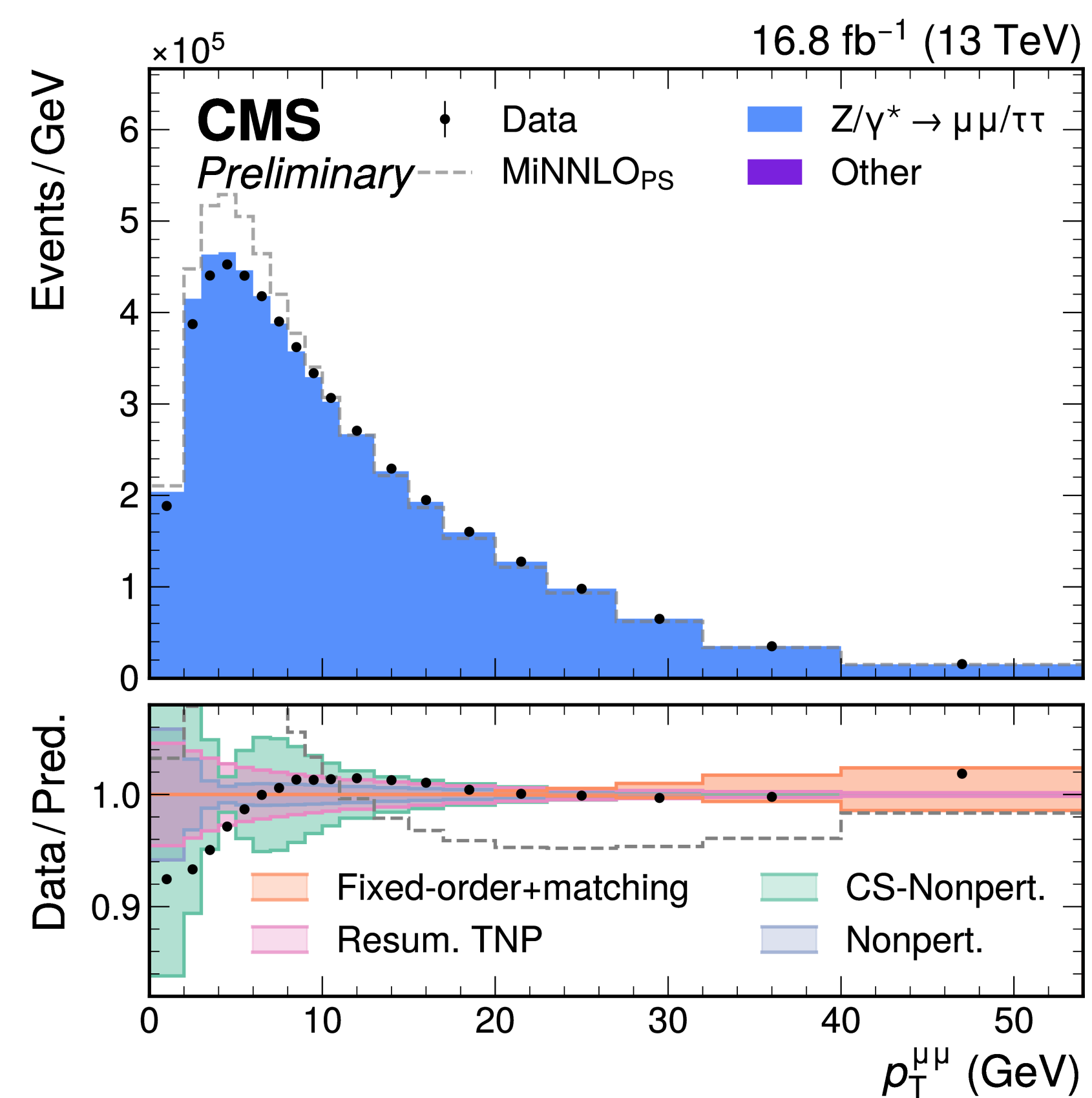

Perturbative uncertainties

- “Theory nuisance parameters” calculated from SCETlib at N³LL and propagated through analysis
 - Structure of resummation is known to all orders, many corrections are (unknown) numerical constants
 - Parameterize elements of resummation series, uncertainties directly represent unknown terms
 - Meaningful shape variation (**critical!**) and meaningful constraints from data
 - **Unc. in m_W ~ 0.5 MeV**

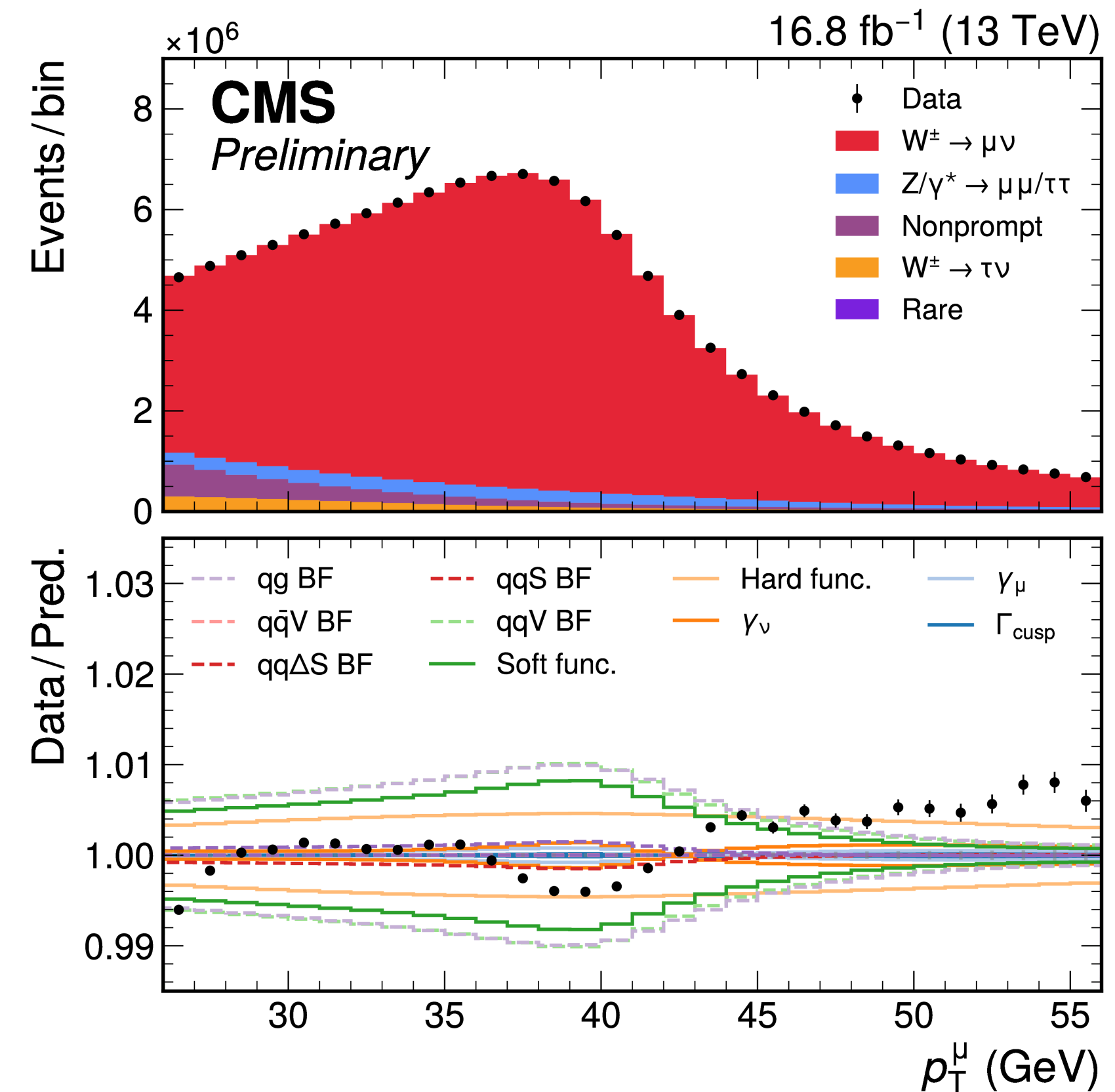
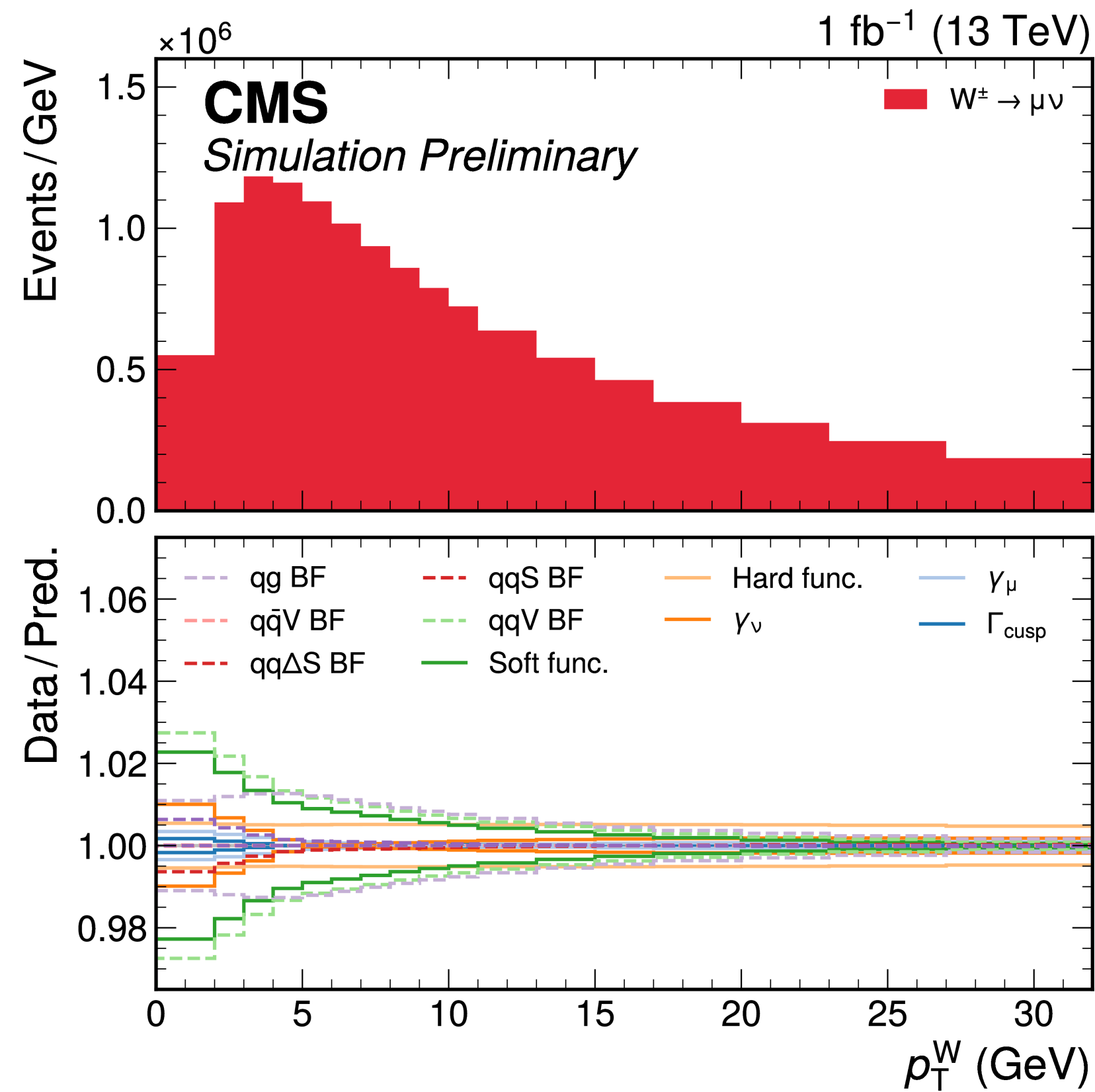

Sufficiency of the theoretical model

- General strategy: **do not tune parameters of the theoretical models**
 - Robust parameterization, uncertainties + data corrections extracted from maximum likelihood fit
- Direct maximum likelihood fit to $(y^{\mu\mu}, p_{T^{\mu\mu}})$ is first test of sufficiency of this approach
 - **P-value of 16%**

➔ Total unc. in m_W 2.0 MeV

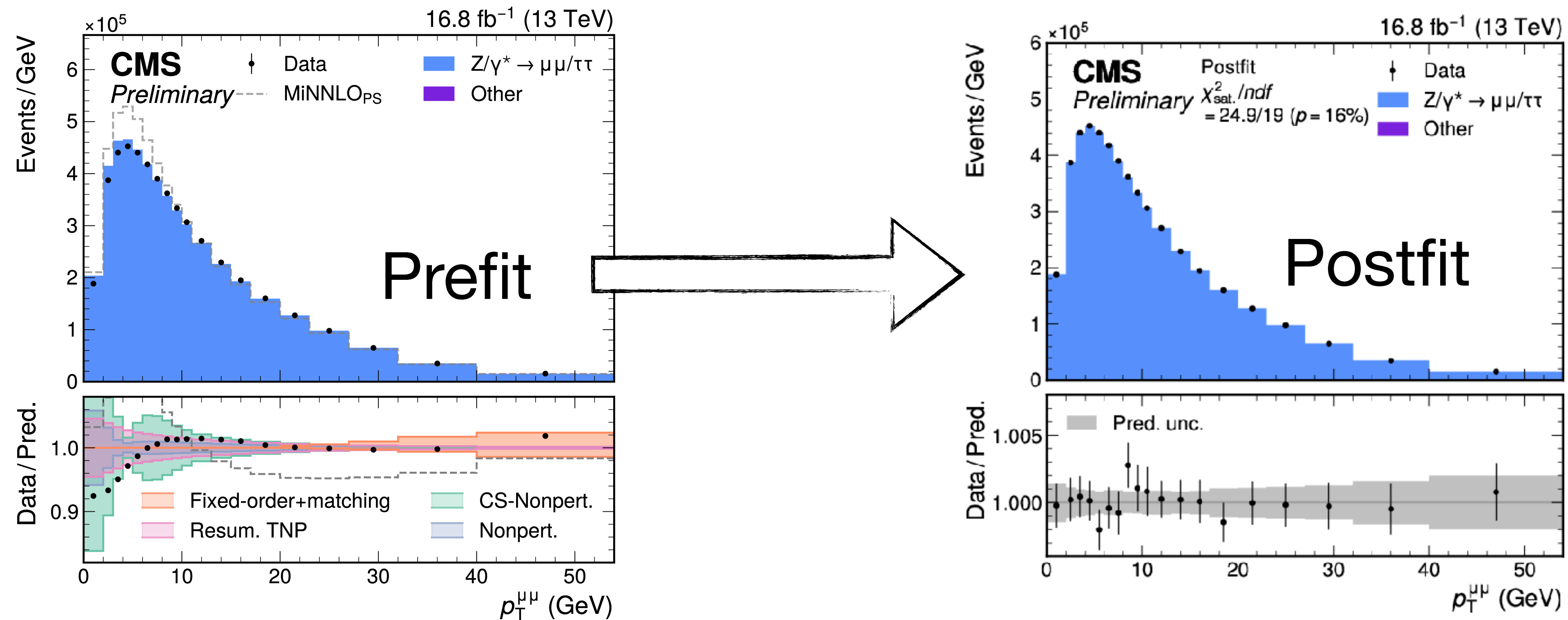

ATLAS: tune Pythia to p_{T^Z} (5 MeV unc.)

CDF: Tune Resbos+reduce unc. from data comparisons (2 MeV unc.)

Theoretical modeling: PDF



- PDF uncertainty impacts W production (and decay)
- Derived from the fitted experimental data (with tolerance)
 - Well defined statistical treatment
 - But... sets with different parameterisations+slightly different datasets are not necessarily covered by uncertainties of others
 - ➔ Seen in wide range of precision measurements
- **No PDFs include theory unc.** (approx. in special MSHT20, NNPDF)

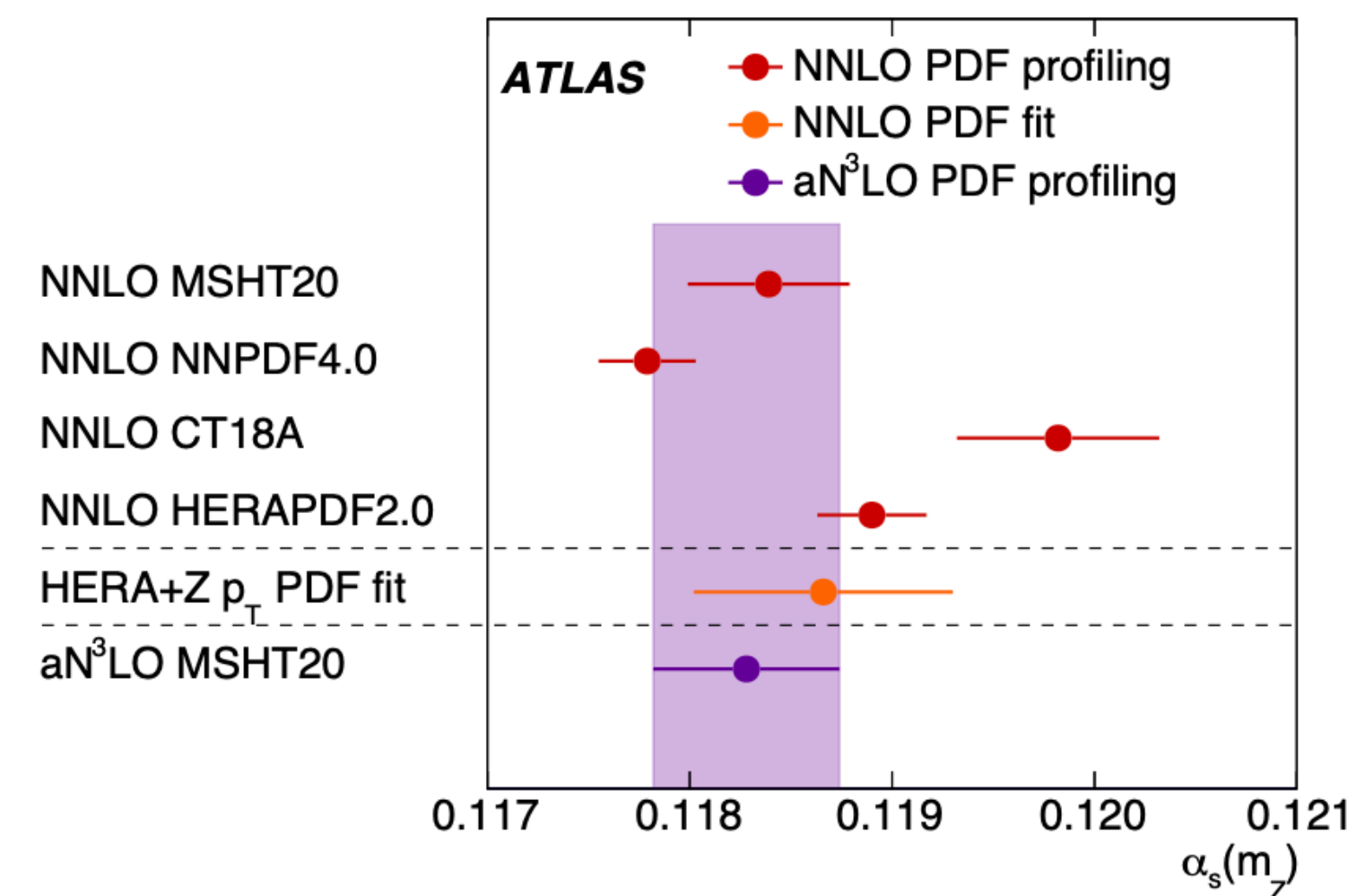
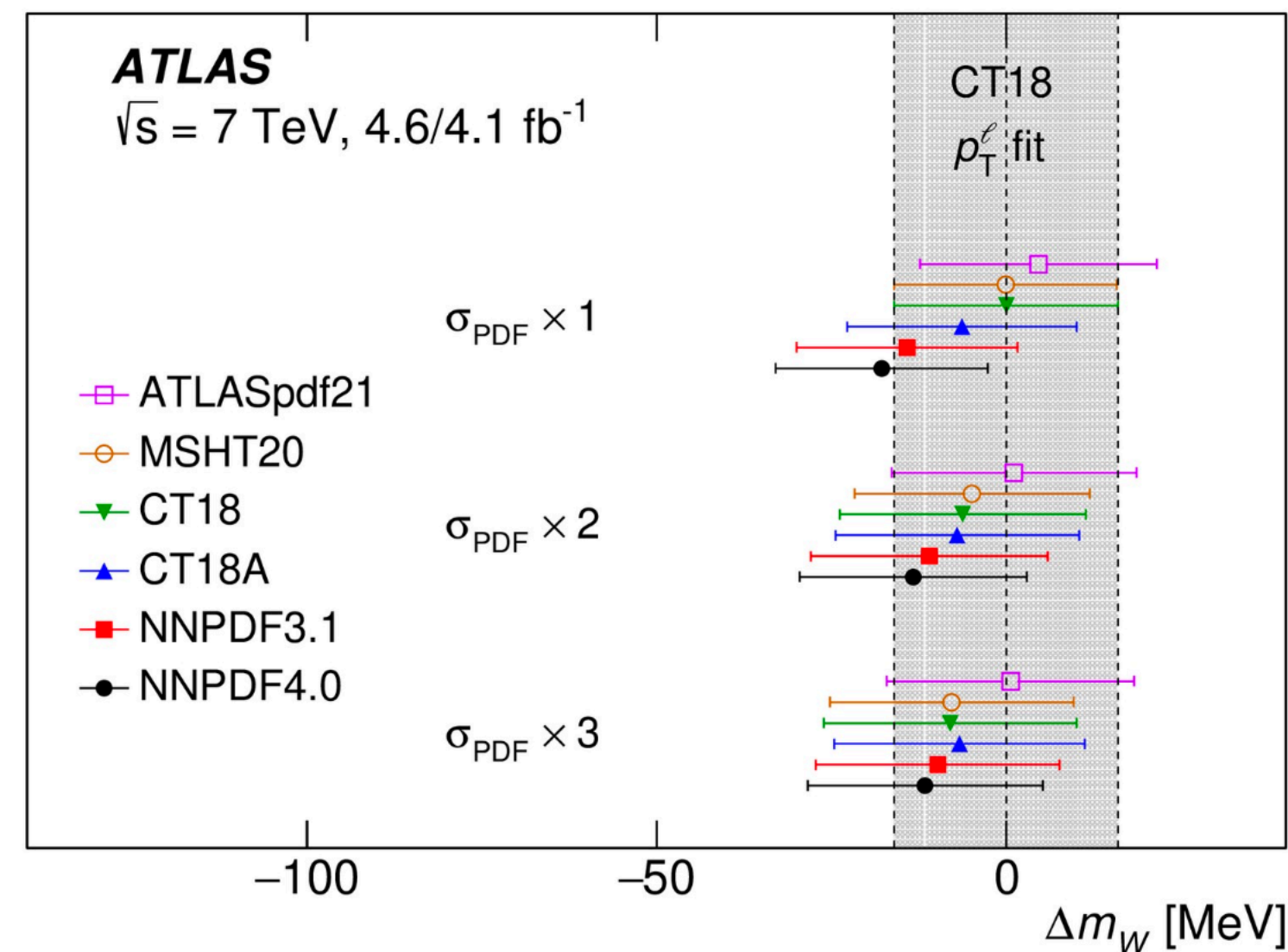
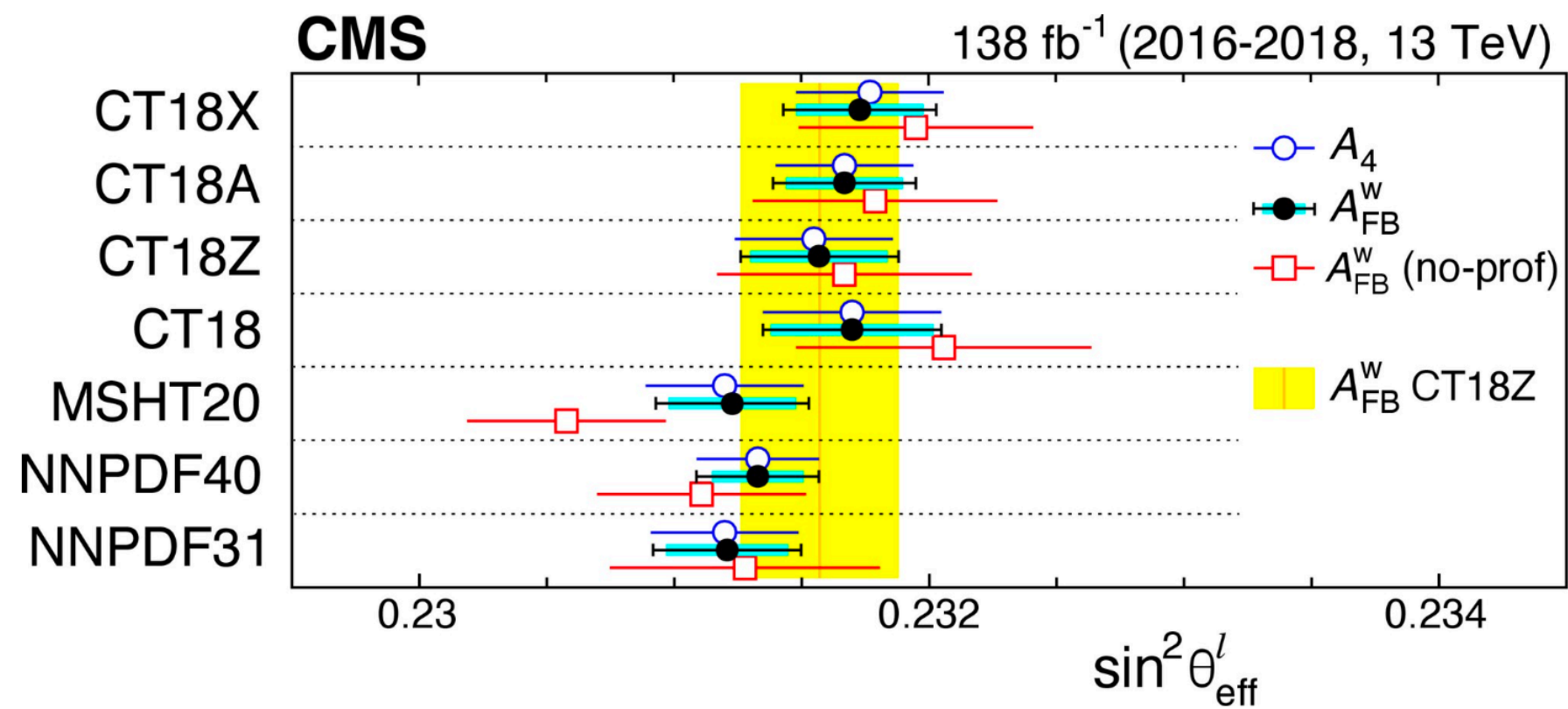
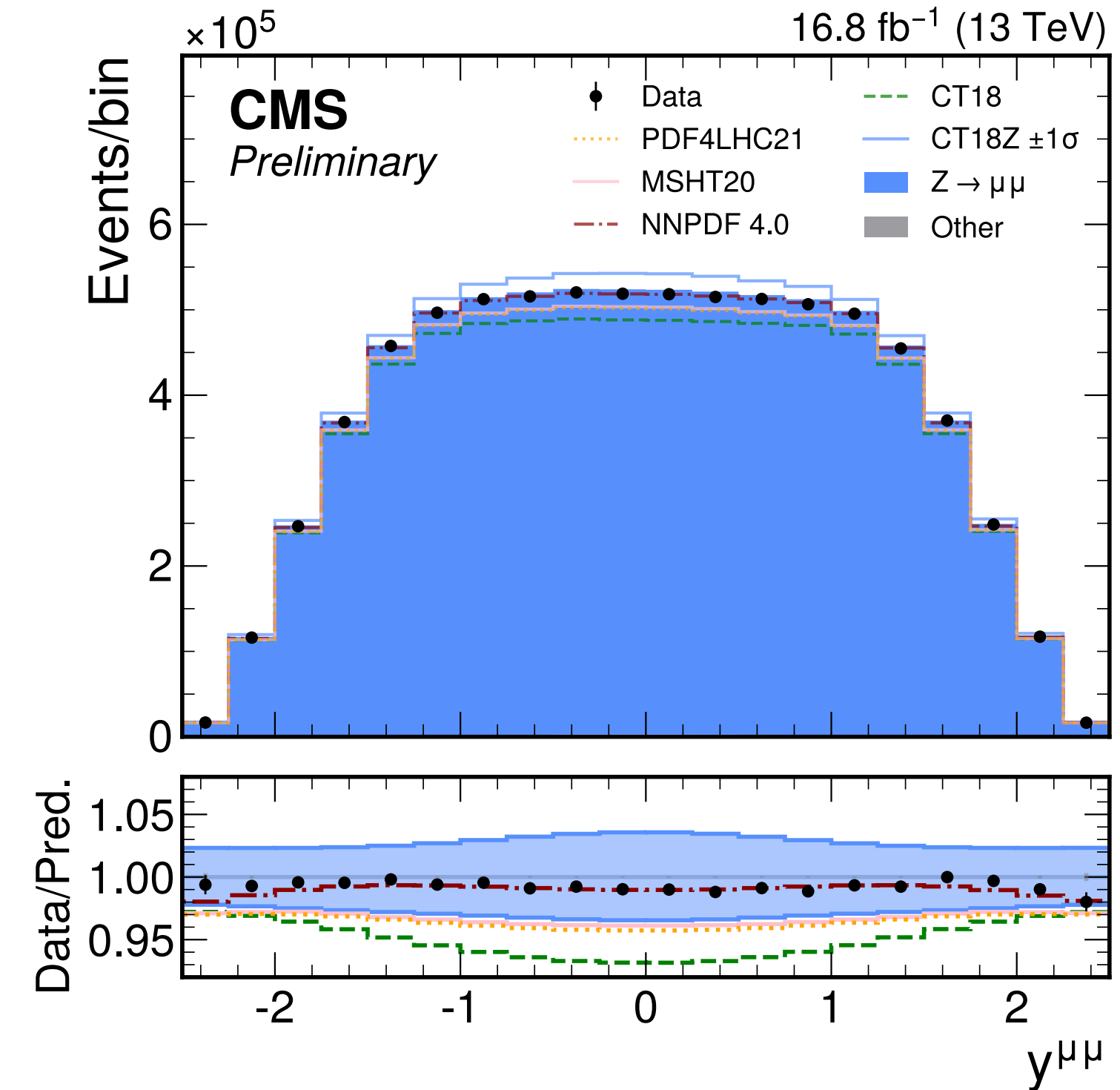

- Studied the impact of 8 modern PDF sets in our analysis
 - Compare consistency of sets with bias tests:
 - Consider one as MC prediction and others as pseudo data
 - Derive scaling factors per PDF set from bias studies
 - ➔ Results for m_W with derived scaling and unscaled
- **Select CT18Z as nominal set** because of coverage of other sets and consistency with our data
 - ➔ 4.4 MeV in m_W

PDF set	Scaling factor	Impact on m_W	
		Original σ_{PDF}	Scaled σ_{PDF}
CT18Z	1.0	4.4	
CT18	1.0	4.6	
PDF4LHC21	1.0	4.1	
MSHT20	1.5	4.3	5.1
MSHT20an3lo	1.5	4.2	4.9
NNPDF3.1	3.0	3.2	5.3
NNPDF4.0	5.0	2.4	6.0

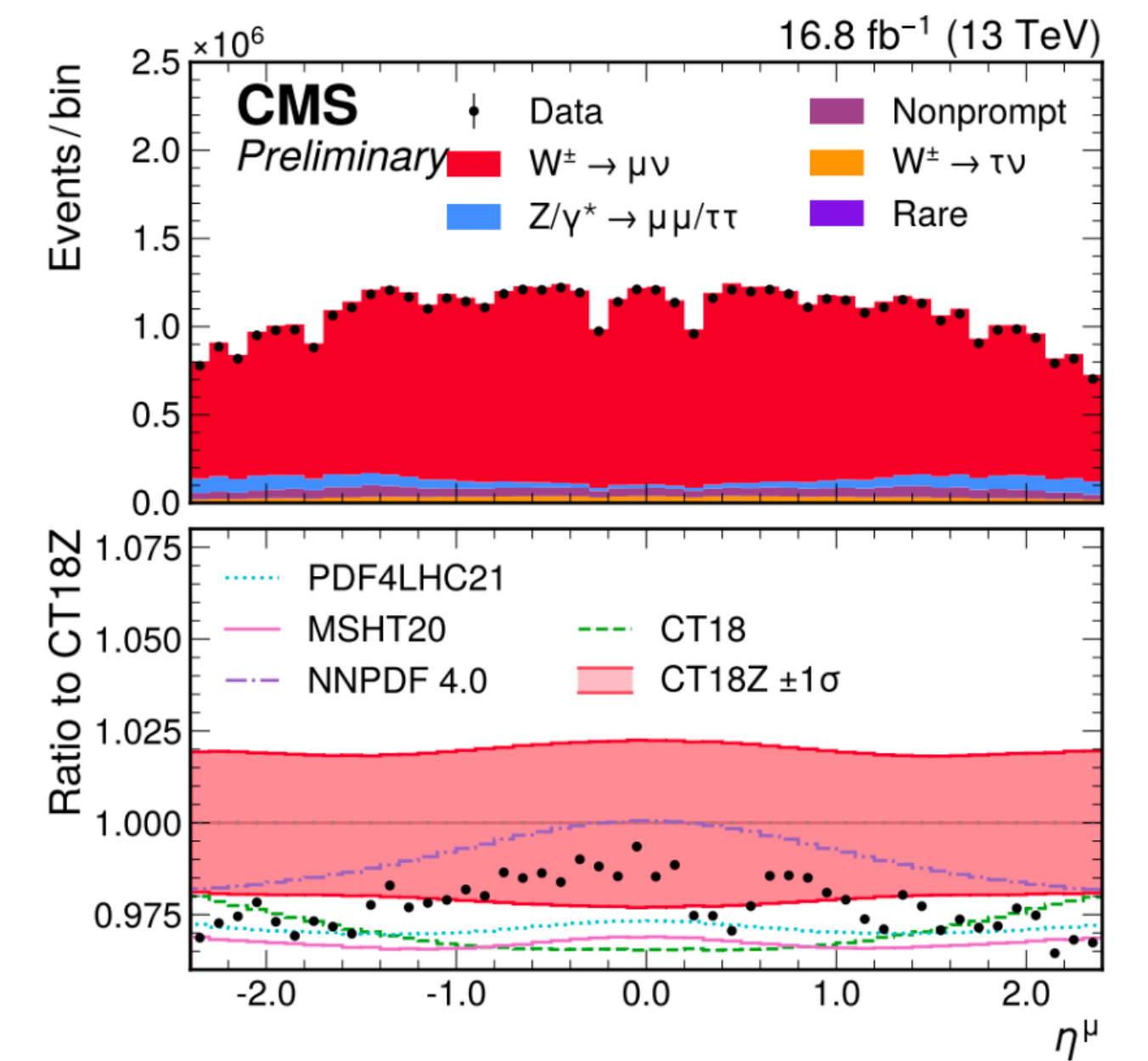
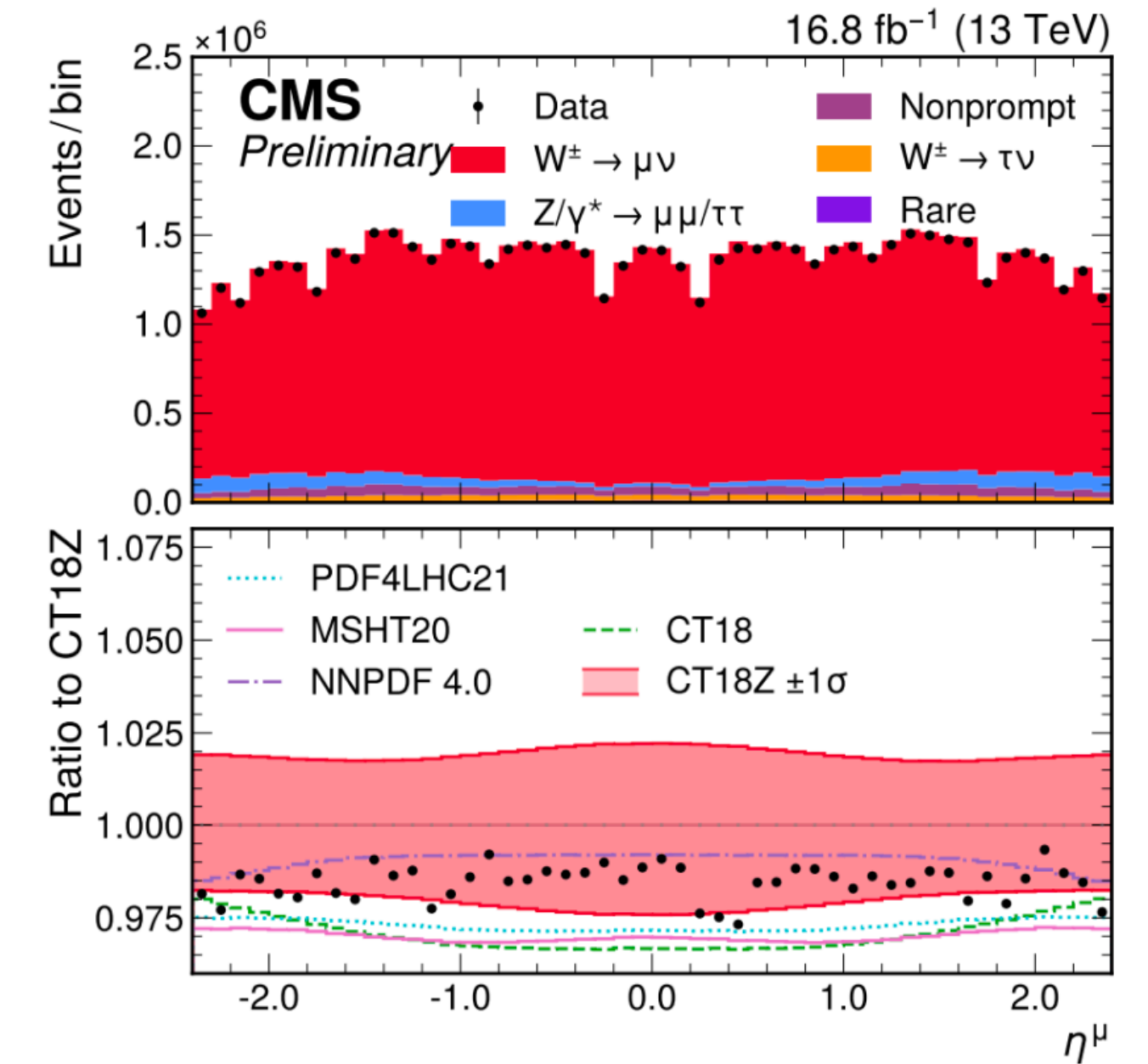

W/Z helicity states and impact on lepton kinematics

- For a given helicity state, **relationship between $V = W, Z$ and decaying leptons is known analytically** (up to small higher-order QED corrections)

$$\frac{d\sigma}{dp_T^2 dm dy d\cos\theta^* d\phi^*} = \frac{3}{16\pi} \underbrace{\frac{d\sigma_{UL}}{dp_T^2 dm dy}}_{\text{Kinematics of W/Z}} \left[(1 + \cos^2\theta^*) + \underbrace{\sum_{i=0}^7 A_i(p_T, m, y)}_{\text{Angular coefficients (Predicted by pQCD)}} \cdot \underbrace{P_i(\cos\theta^*, \phi^*)}_{\text{Spherical harmonics of decay angles in CS frame}} \right]$$

Kinematics of W/Z

Angular coefficients
(Predicted by pQCD)

Spherical harmonics of
decay angles in CS frame

- Modifications of A_i **change relationship between p_T^V and p_T^μ**
 - Estimated at NNLO with MiNNLO, verified consistency with fixed-order NNLO
 - Uncertainty from scale variations, uncorrelated across 10 bins of p_T^V

➔ **3.3 MeV unc. in m_W**

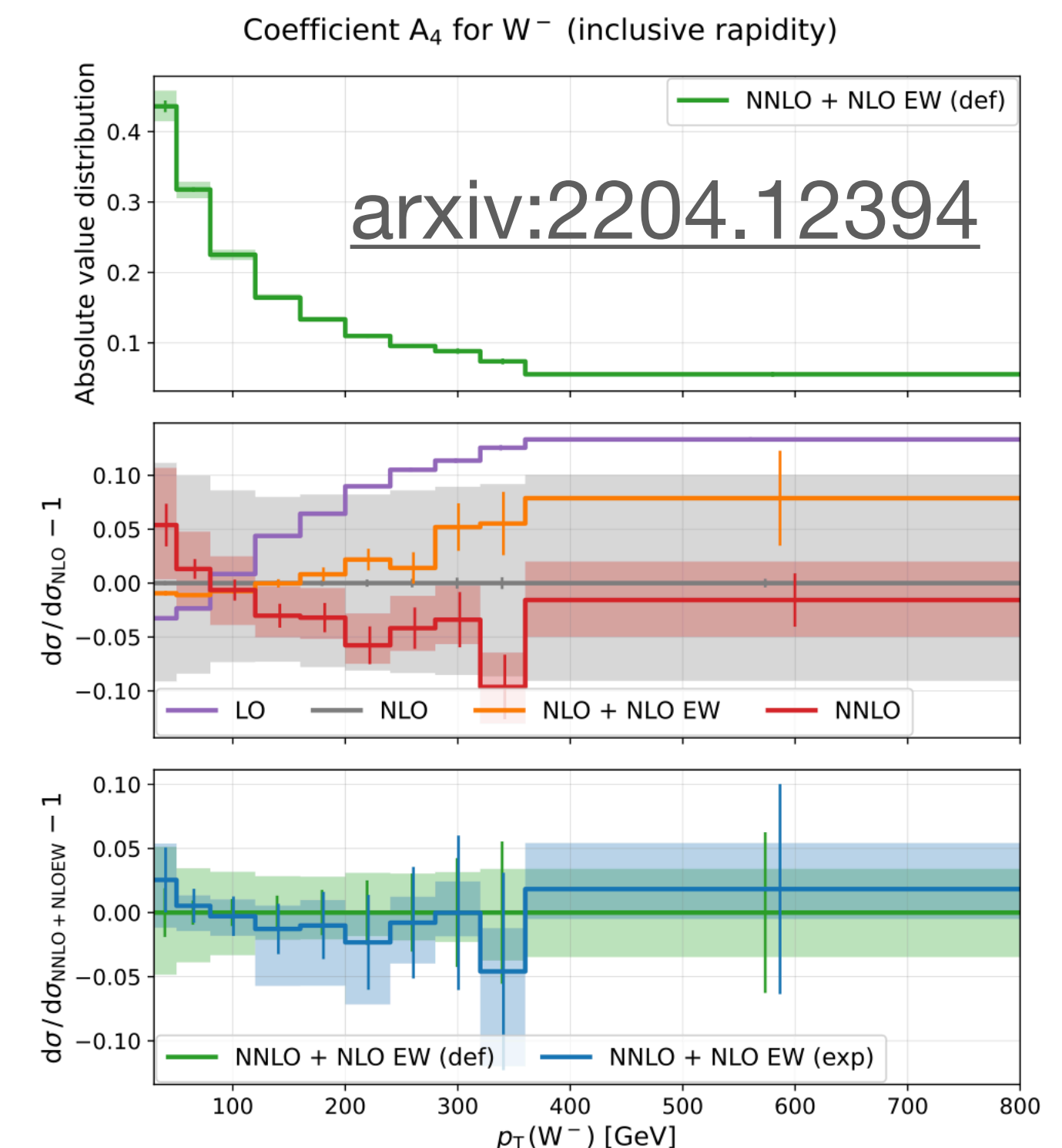

W/Z helicity states and impact on lepton kinematics

- For a given helicity state, **relationship between $V = W, Z$ and decaying leptons is known analytically** (up to small higher-order QED corrections)

$$\frac{d\sigma}{dp_T^2 dm dy d\cos\theta^* d\phi^*} = \frac{3}{16\pi} \underbrace{\frac{d\sigma_{UL}}{dp_T^2 dm dy}}_{\text{}} \left[(1 + \cos^2\theta^*) + \sum_{i=0}^7 \underbrace{A_i(p_T, m, y)}_{\text{}} \cdot \underbrace{P_i(\cos\theta^*, \phi^*)}_{\text{}} \right]$$

- Exploit this relationship for **alternative theory-reduced measurement (helicity cross-section fit)**

- Measure (y^V, p_T^V) : divide (η^V, p_T^V) templates by A_i
- ~600 parameters, binned in (y^V, p_T^V) per A_i , loosely constrained around theory
 - Uncertainty in σ_{UL} (σ_4) of 50% (100%), others constrained by envelope of theory unc (e.g., different PDFs)

➡ Larger stat. uncertainty but reduced theory dependence

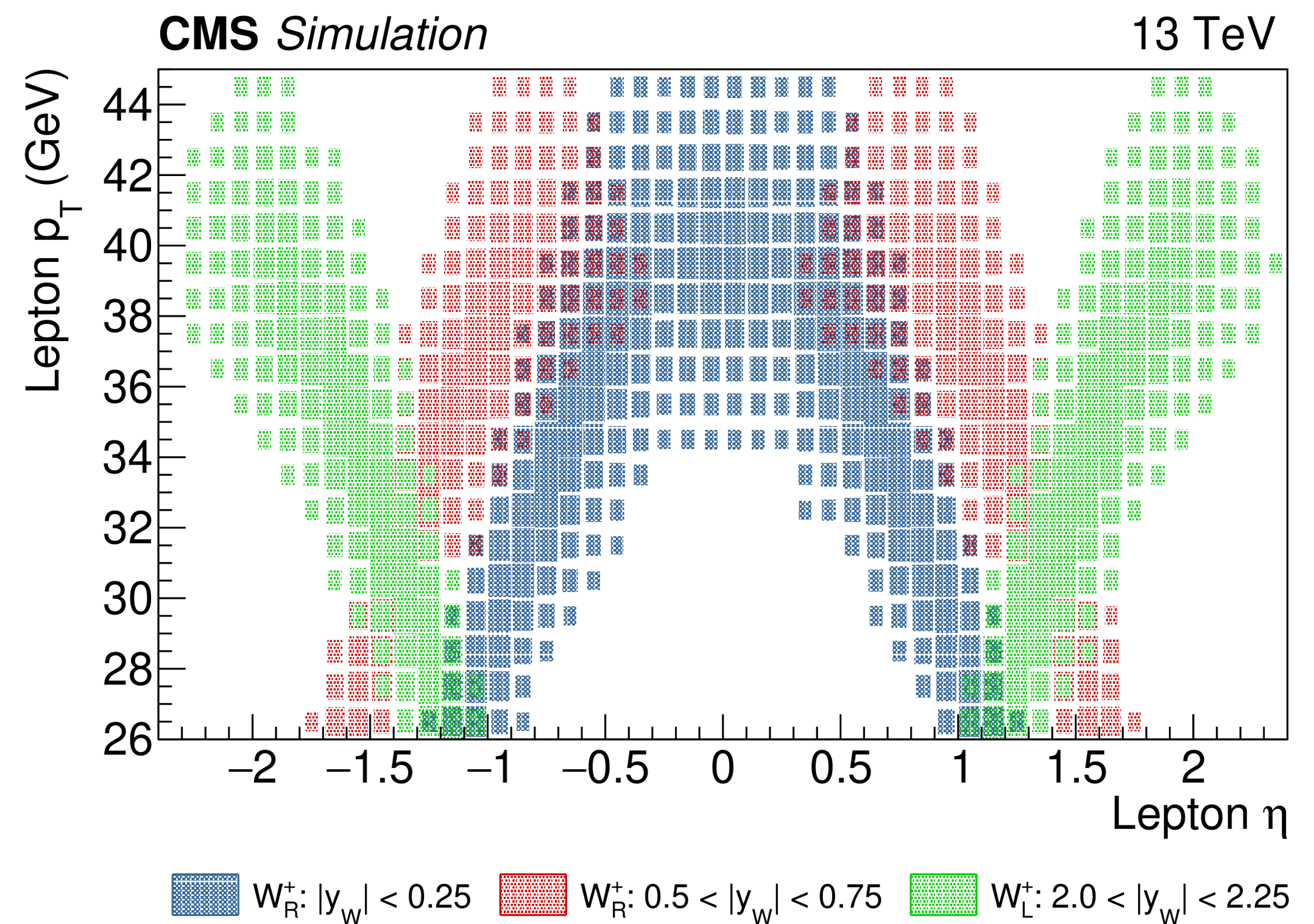

(R,L related to A_4)

★ Extracting m_Z from fit to (η^μ, p_{T^μ})

- W-like measurement of m_Z using approach developed for m_W
 - Split into two data samples to avoid need for evaluating correlations within events
 - Both results highly consistent with PDG (LEP)

$$m_Z - m_Z^{\text{PDG}} = -6 \pm 14 \text{ MeV}$$

Source of uncertainty	Impact (MeV)	
	Nominal	Global
Muon momentum scale	5.6	5.3
Muon reco. efficiency	3.8	3.0
W and Z angular coeffs.	4.9	4.5
Higher-order EW	2.2	2.2
p_T^V modeling	1.7	1.0
PDF	2.4	1.9
Integrated luminosity	0.3	0.2
MC sample size	2.5	3.6
Data sample size	6.9	10.1
Total uncertainty	13.5	13.5

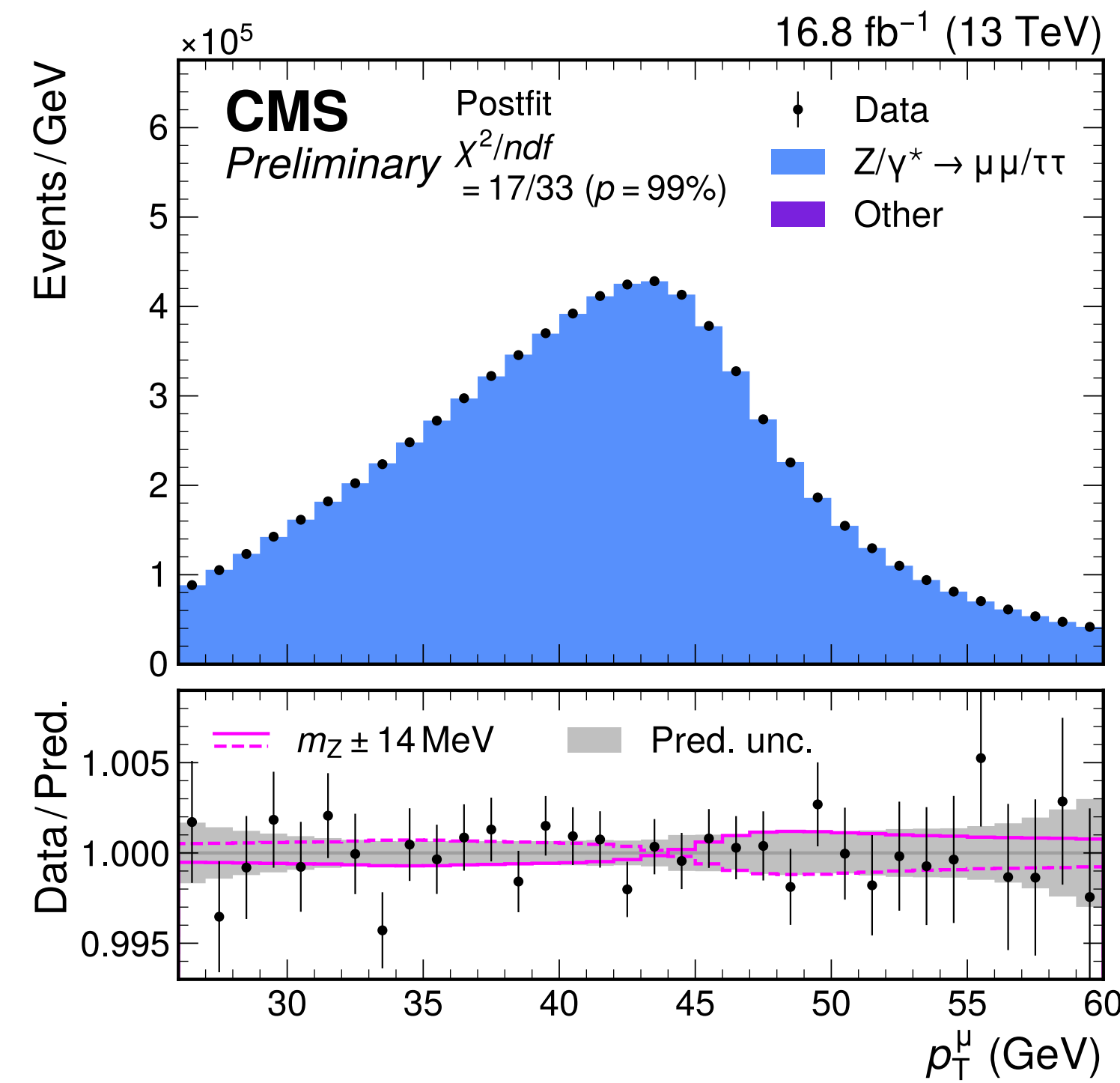
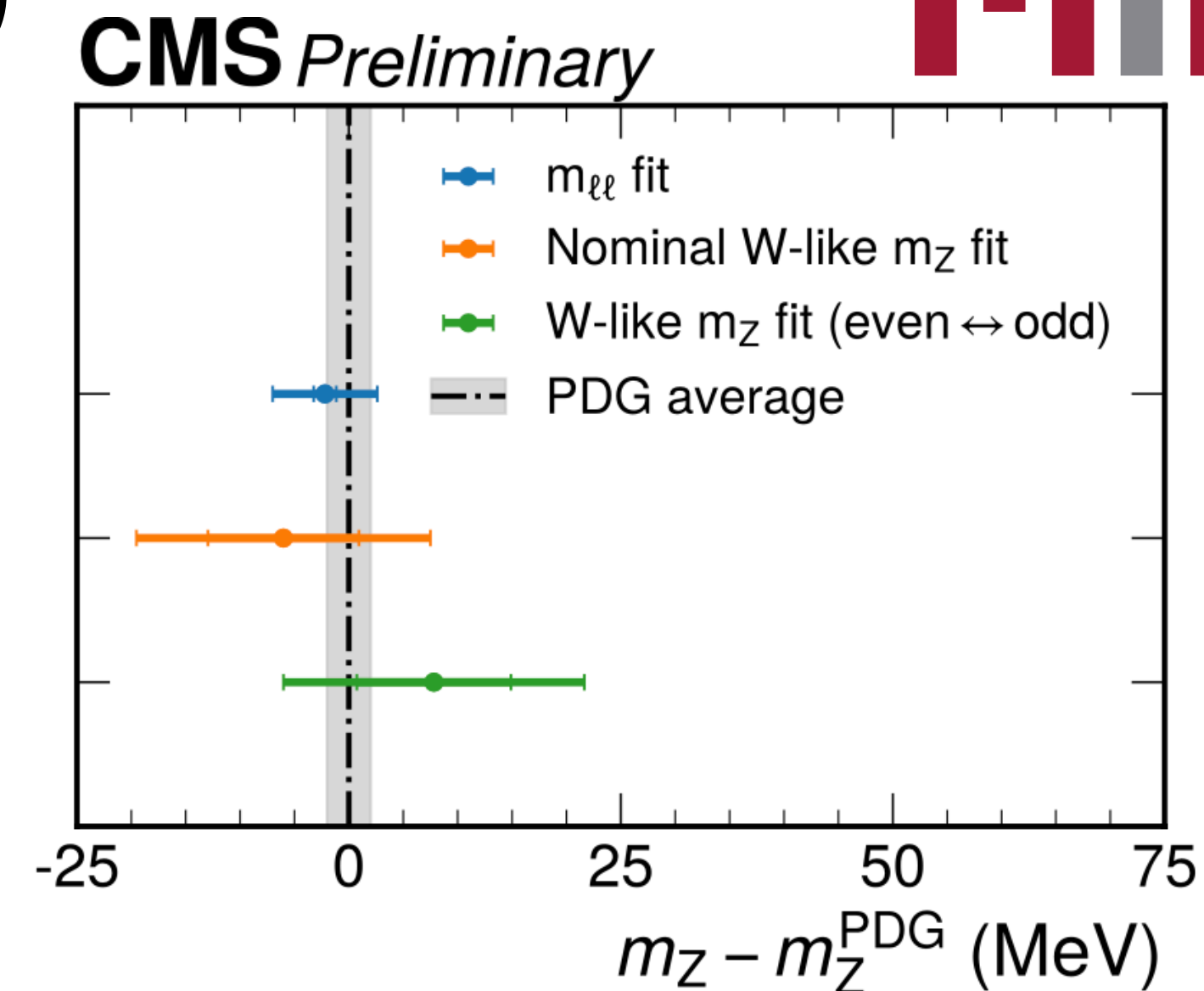

- Propagate postfit pulls and constraints of theory uncertainties to generator-level distributions
 - In situ corrections from data
- Compare
 - Unfolded $p_{T^{\mu\mu}}$ data
 - Direct fit to $p_{T^{\mu\mu}}$
 - W-like (η^μ, p_{T^μ}) fit
- ➔ Strong and consistent constraints between direct fit to and $p_{T^{\mu\mu}}$ to p_{T^μ}
- (η^μ, p_{T^μ}) distribution able to simultaneously correct $p_{T^{\mu\mu}}$ and extract m_Z without bias
- ➔ Justifies performing m_W measurement without corrections from $p_{T^{\mu\mu}}$

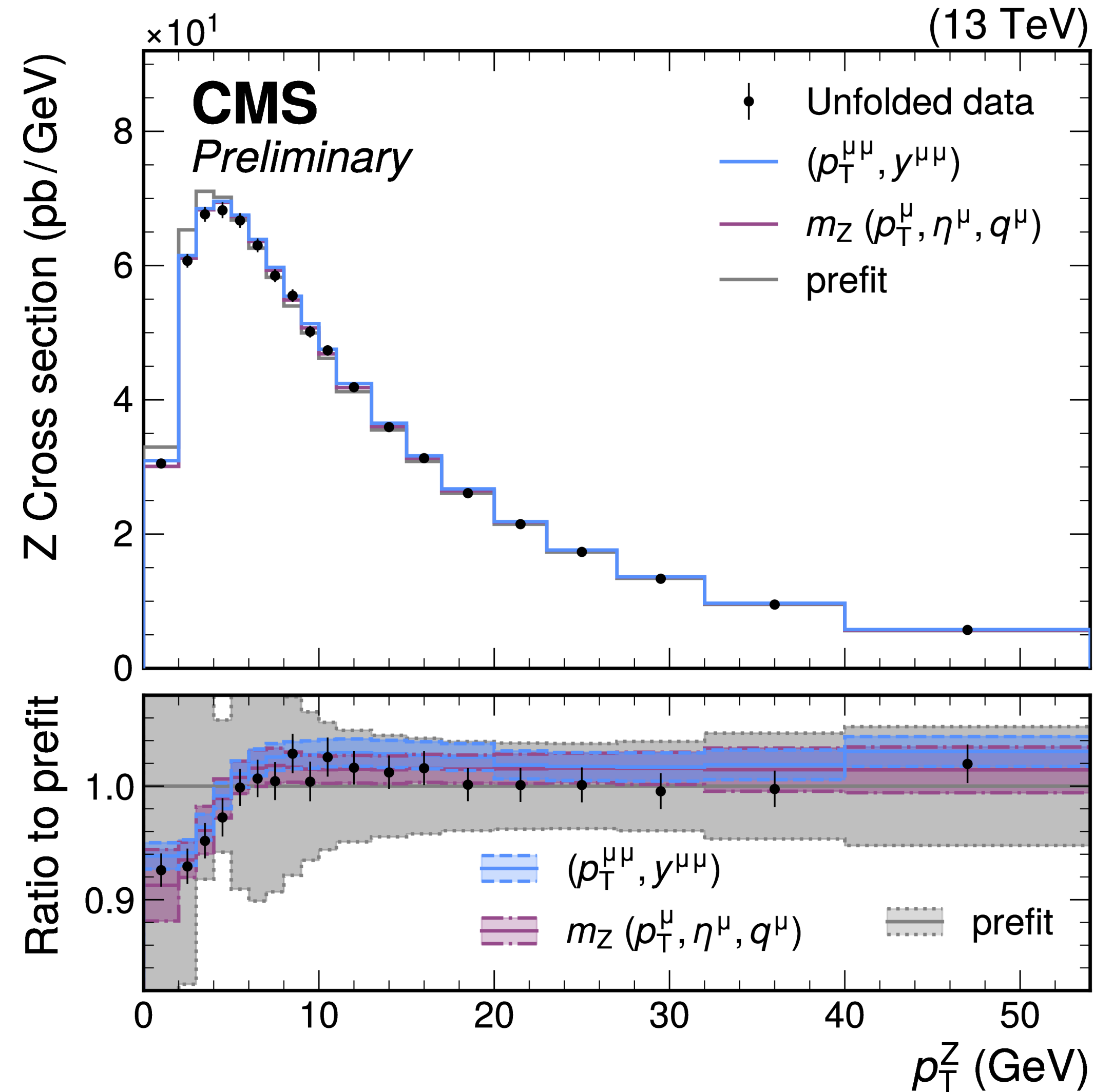

★ Extracting m_W from fit to (η^μ, p_T^μ)

- Total uncertainty of 9.9 MeV
 - Muon momentum scale and PDF dominant unc.

$m_W = 80360.2 \pm 9.9 \text{ MeV}$

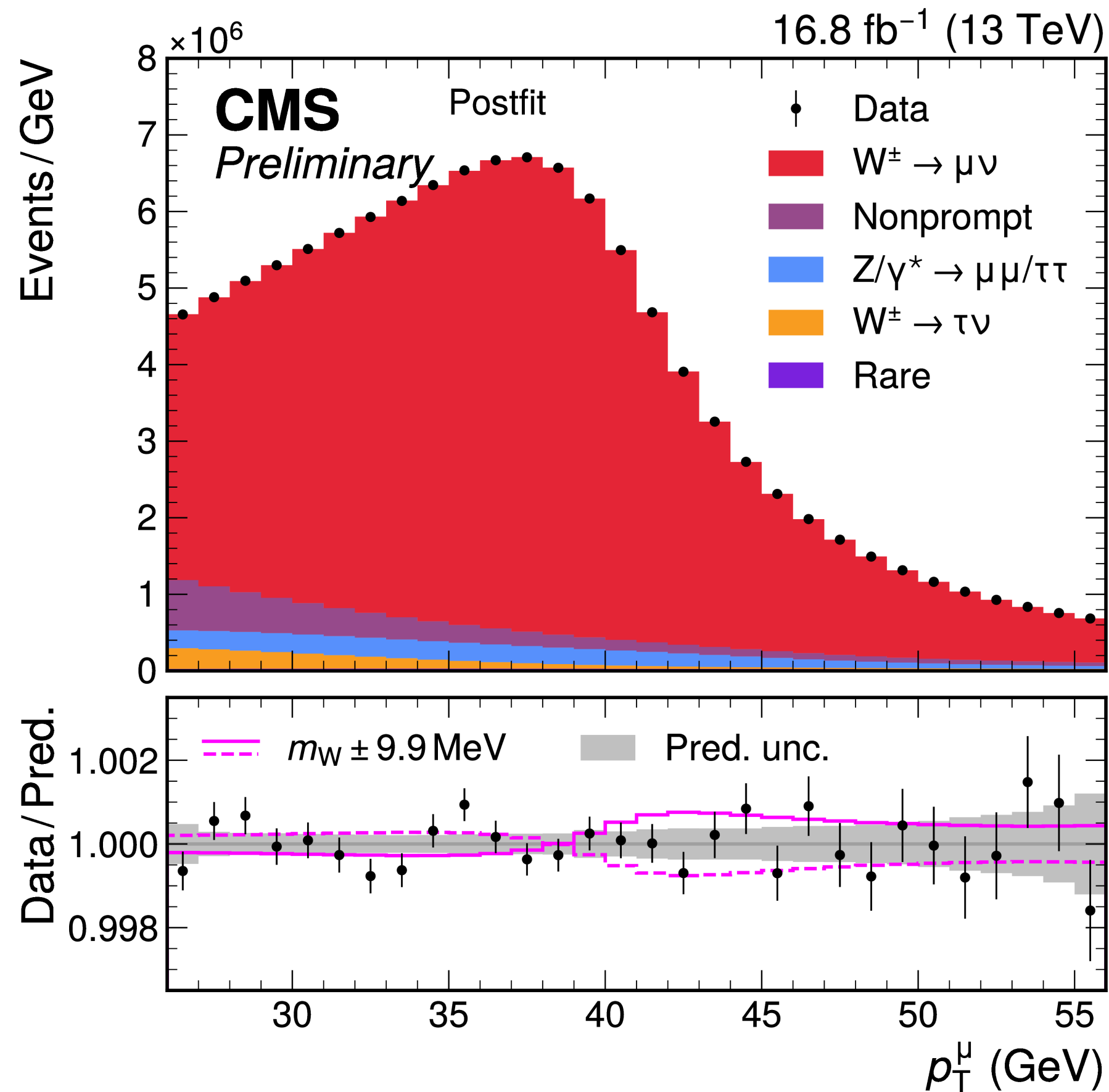

Source of uncertainty	Impact (MeV)	
	Nominal	Global
Muon momentum scale	4.8	4.4
Muon reco. efficiency	3.0	2.3
W and Z angular coeffs.	3.3	3.0
Higher-order EW	2.0	1.9
p_T^V modeling	2.0	0.8
PDF	4.4	2.8
Nonprompt background	3.2	1.7
Integrated luminosity	0.1	0.1
MC sample size	1.5	3.8
Data sample size	2.4	6.0
Total uncertainty	9.9	9.9

Comparison to other results

CMS Preliminary

- LEP combination**
Phys. Rep. 532 (2013) 119
- D0**
PRL 108 (2012) 151804
- CDF**
Science 376 (2022) 6589
- LHCb**
JHEP 01 (2022) 036
- ATLAS**
arxiv:2403.15085, subm. to EPJC
- CMS**
This Work

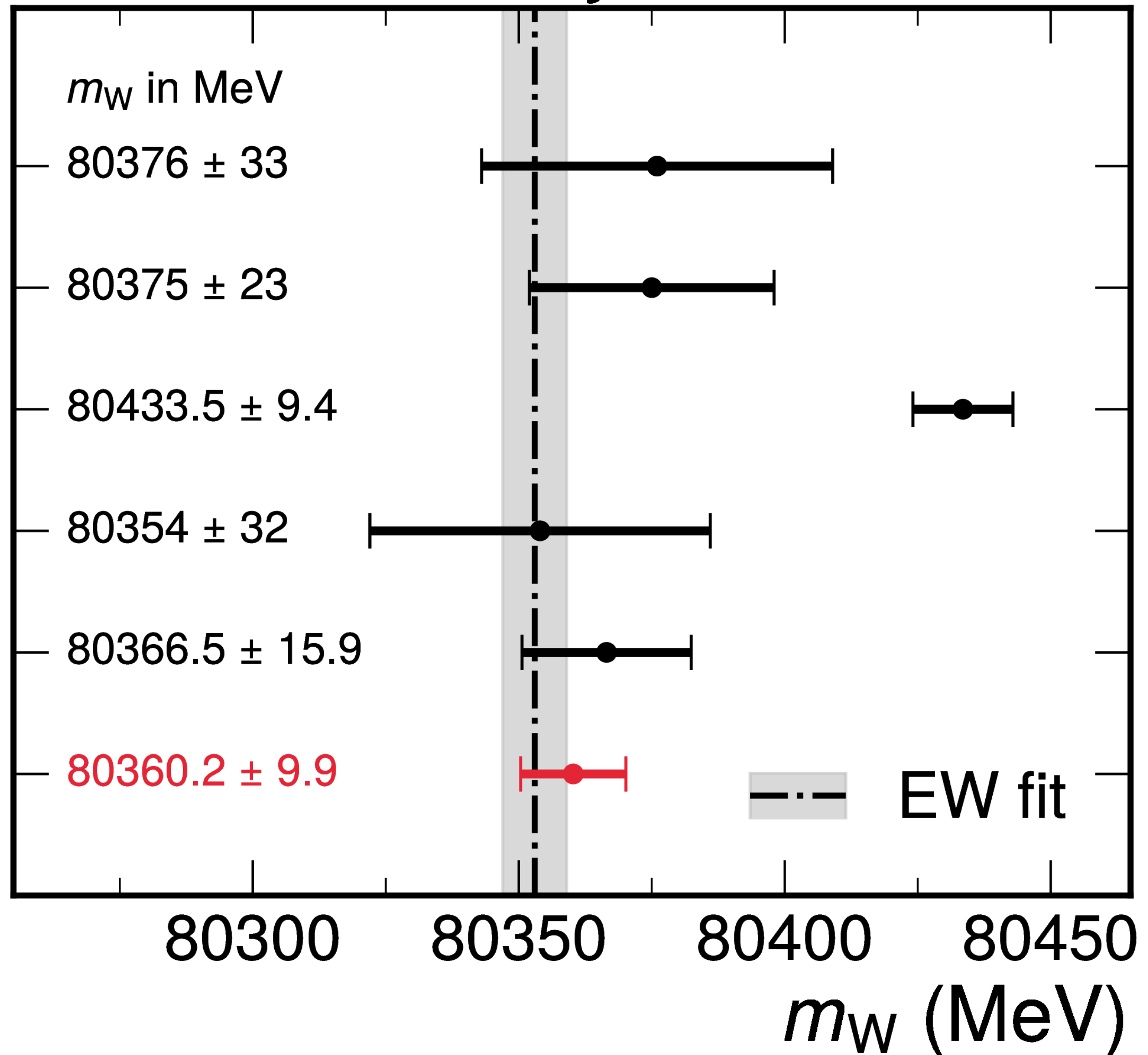

Helicity cross section fit result

$$m_W = 80360.8 \pm 15.2 \text{ MeV}$$

CMS Preliminary (13 TeV)

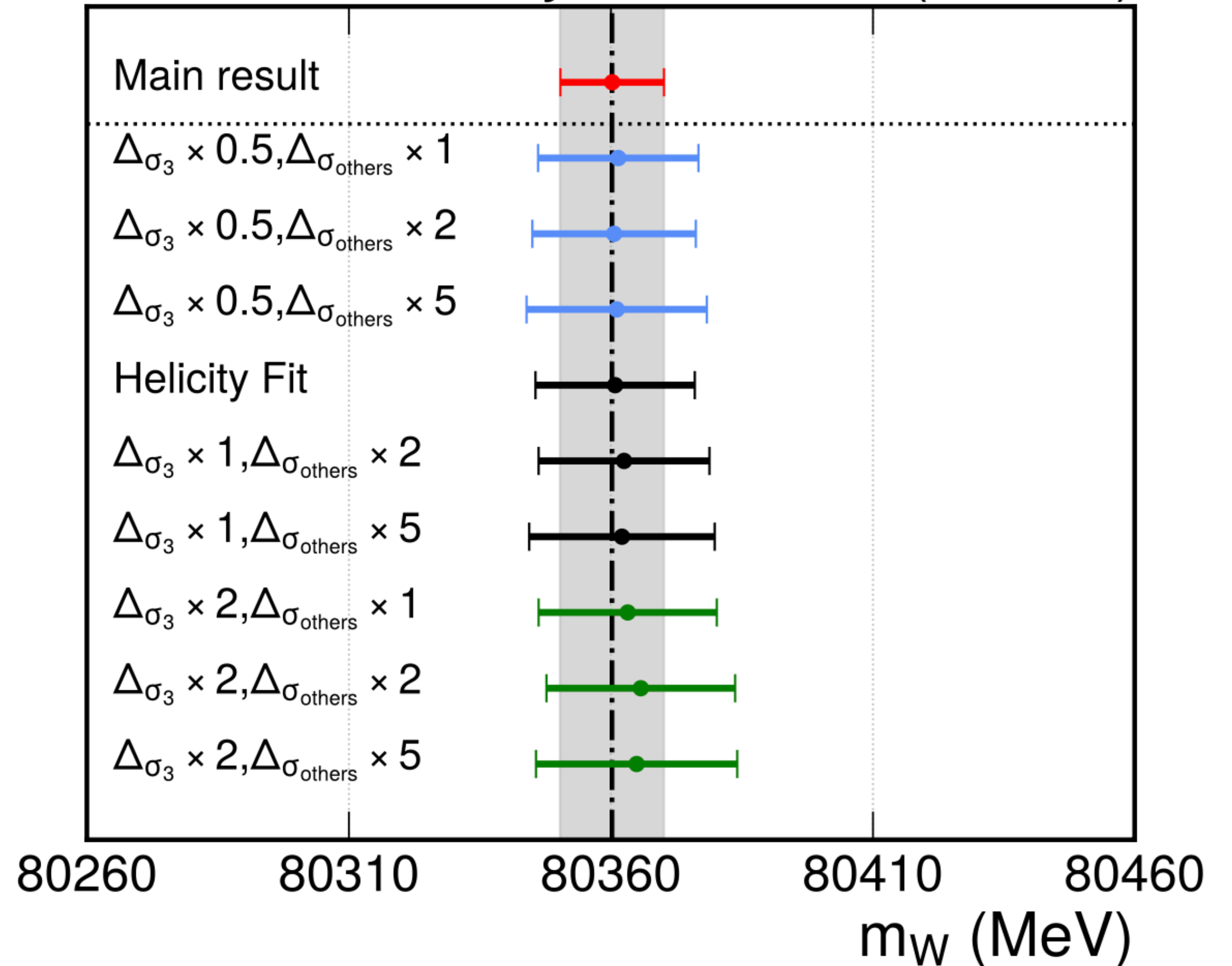

- Helicity cross section fit result very compatible with the nominal
 - Larger uncertainties by design
- Result is stable wrt looser or tighter initial constraints on the helicity cross sections

- Compatibility tested when allowing different m_W parameters per η /charge regions
 - Mass difference between
 - $\eta < 0$ and $\eta > 0$: 5.8 ± 12.4 MeV
 - Barrel vs. endcap: 15.3 ± 14.7 MeV
 - W^+ vs. W^- : 57 ± 30 MeV
 - Charge difference studied extensively, and no clear issues found
 - m_{W^+} and m_{W^-} are highly anti-correlated (-40%)
 - Only 2% correlation between m_{W^+} and m_{W^-}
- ➔ Even if some small charge-dependent correction is underestimated, impact in m_W is very small

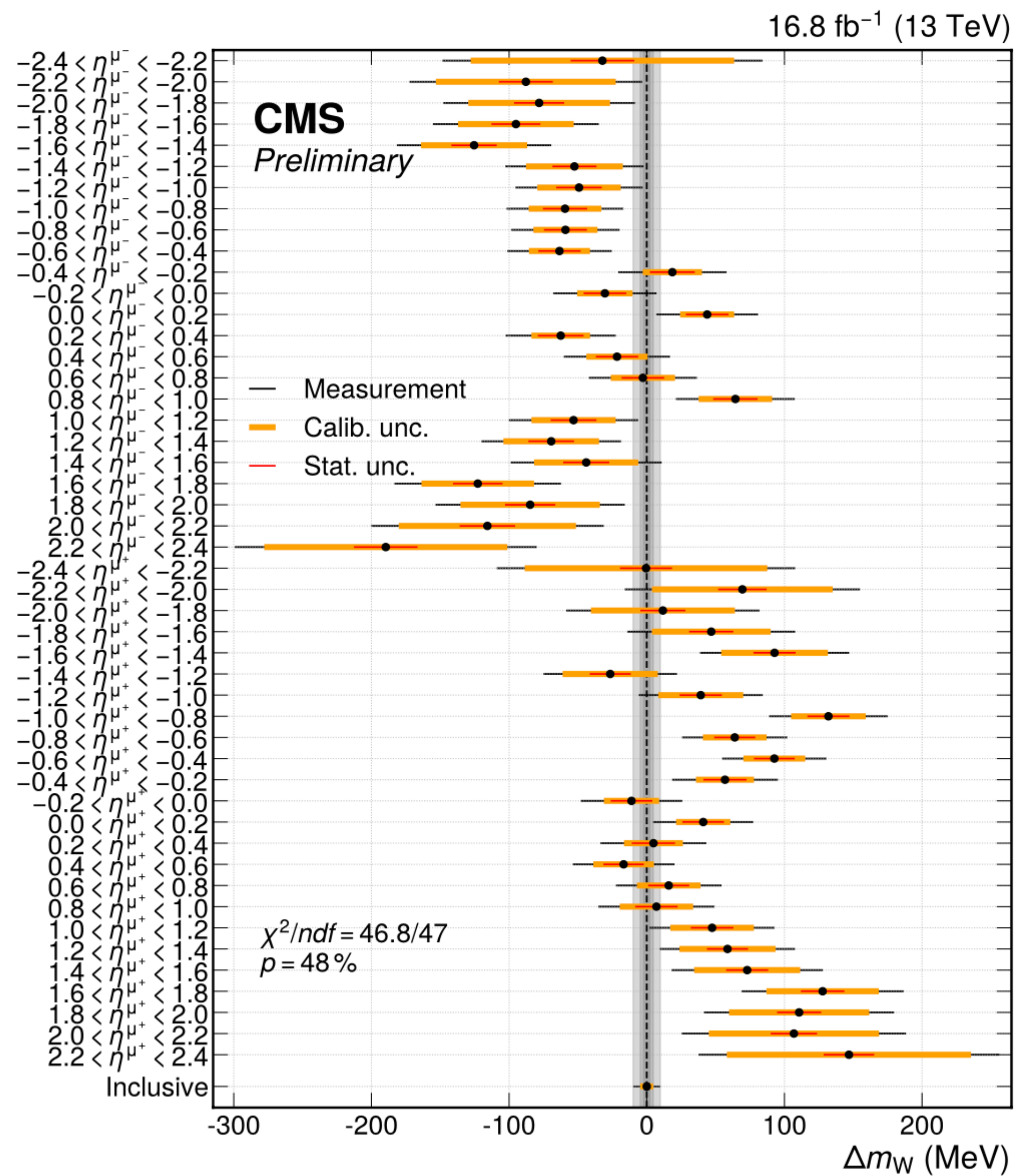

- Tested effect of varying treatment of theoretical uncertainties
 - Partial high-order resummation + theory nuisance parameters
 - Explicit reweighing of p_T^W by measured p_T^Z correction
 - Combined $m_W + p_T^{\mu\mu}$ fit

➔ All results consistent with nominal approach

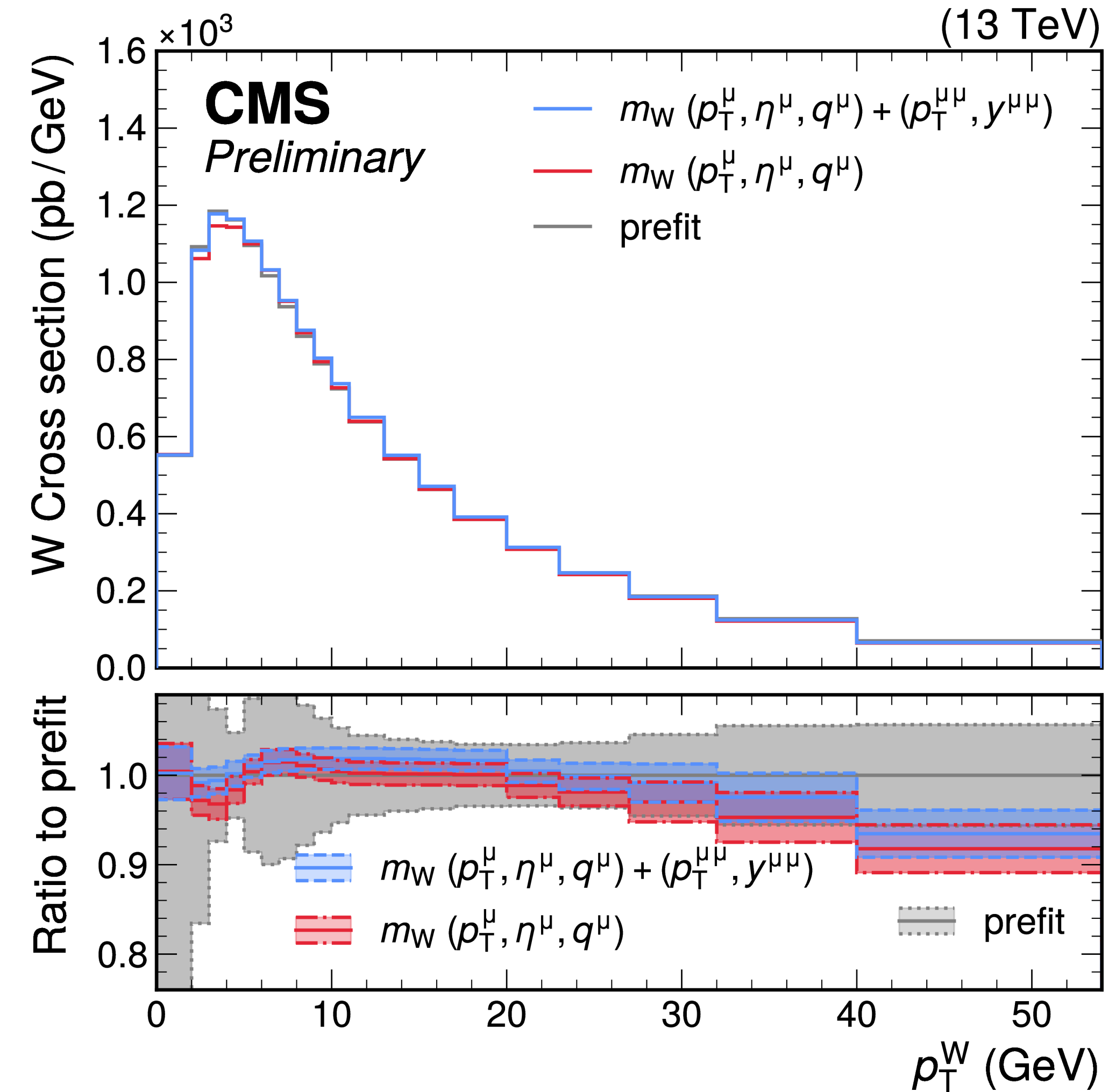
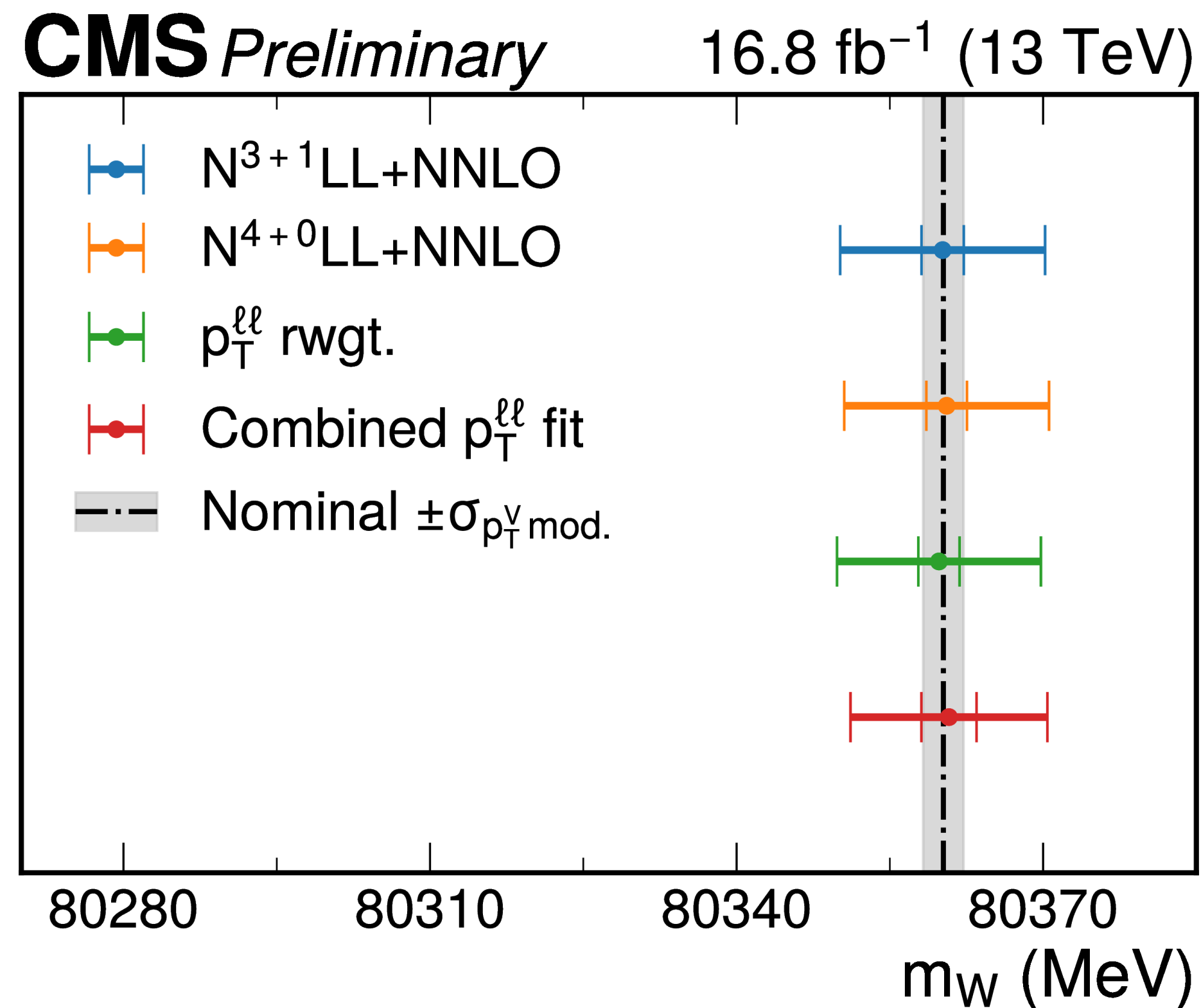

Comparison of generator-level postfit distributions from nominal and combined $m_W + p_T^{\mu\mu}$ fits

Results with alternative PDF sets

- Unc. scaling reduces spread of results, brings all within nominal uncertainty

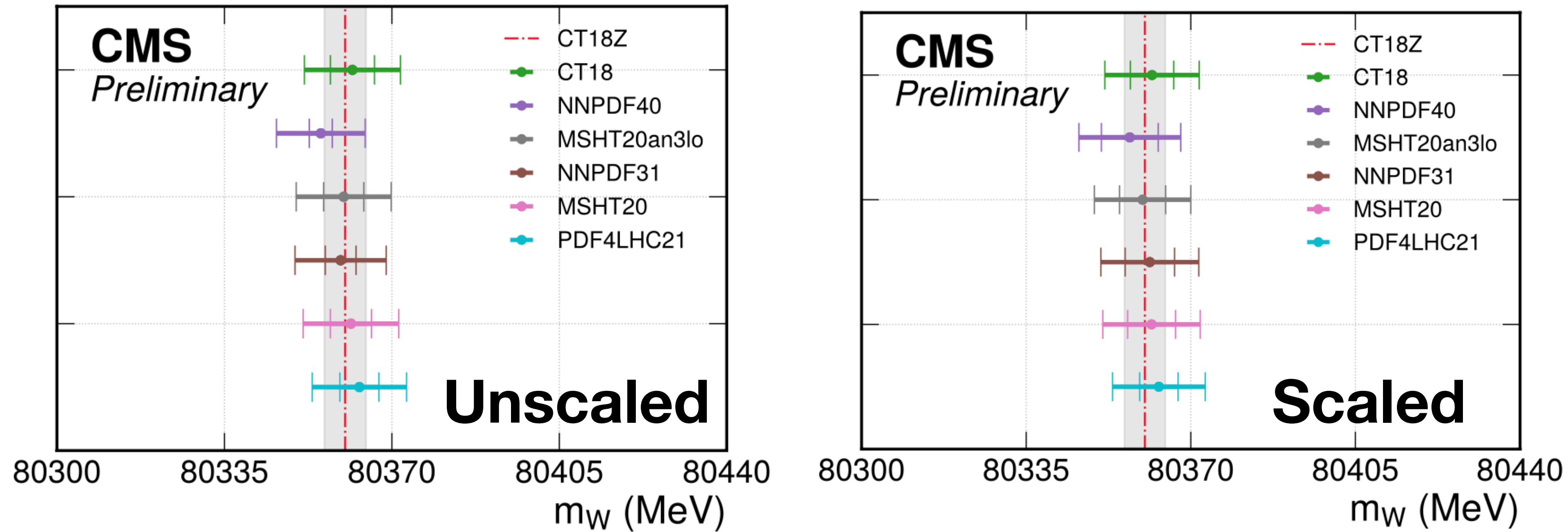

PDF set	Extracted m_W (MeV)	
	Original σ_{PDF}	Scaled σ_{PDF}
CT18Z	80 360.2 \pm 9.9	
CT18	80 361.8 \pm 10.0	
PDF4LHC21	80 363.2 \pm 9.9	
MSHT20	80 361.4 \pm 10.0	80 361.7 \pm 10.4
MSHT20aN3LO	80 359.9 \pm 9.9	80 359.8 \pm 10.3
NNPDF3.1	80 359.3 \pm 9.5	80 361.3 \pm 10.4
NNPDF4.0	80 355.1 \pm 9.3	80 357.0 \pm 10.8

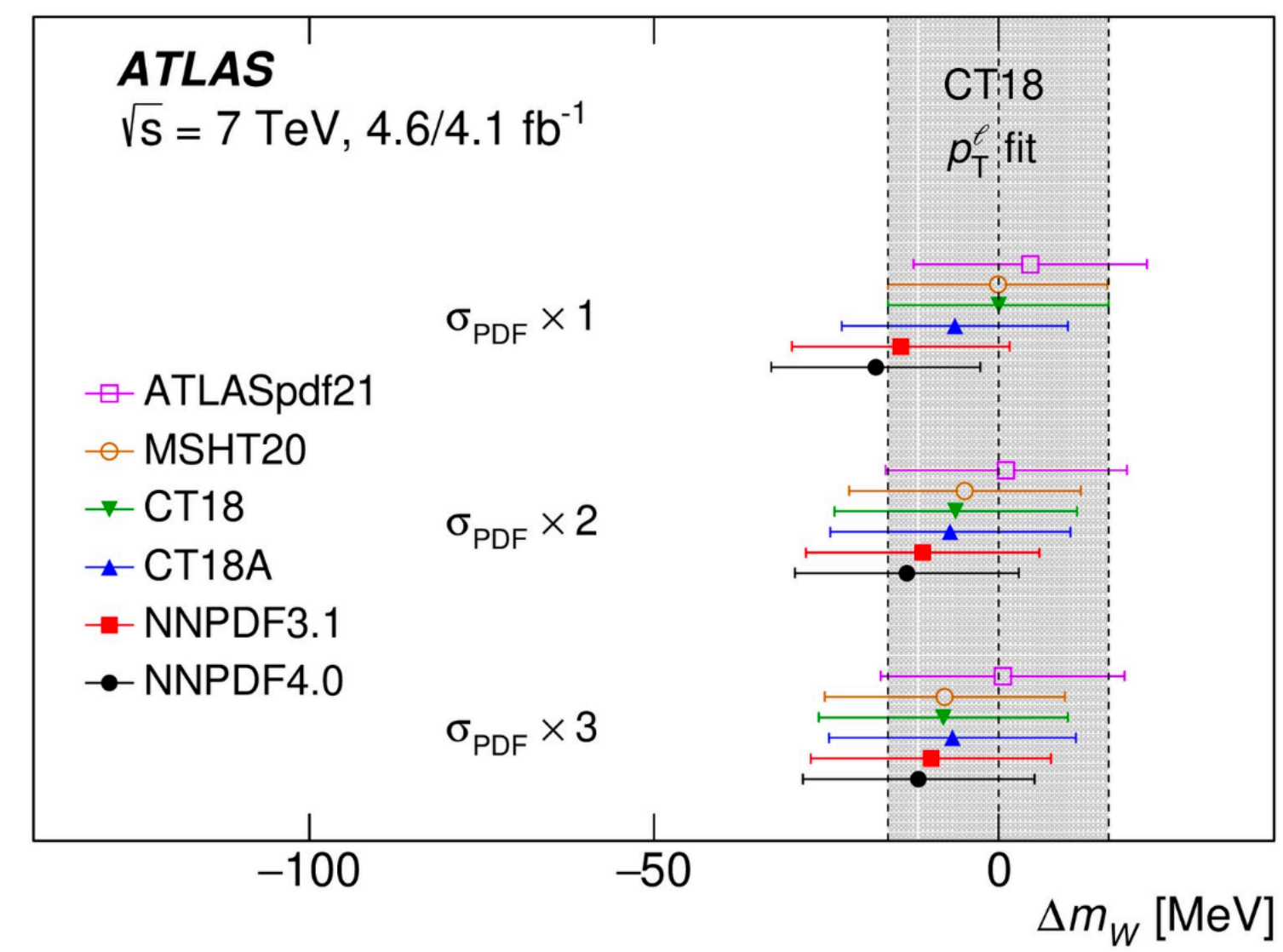

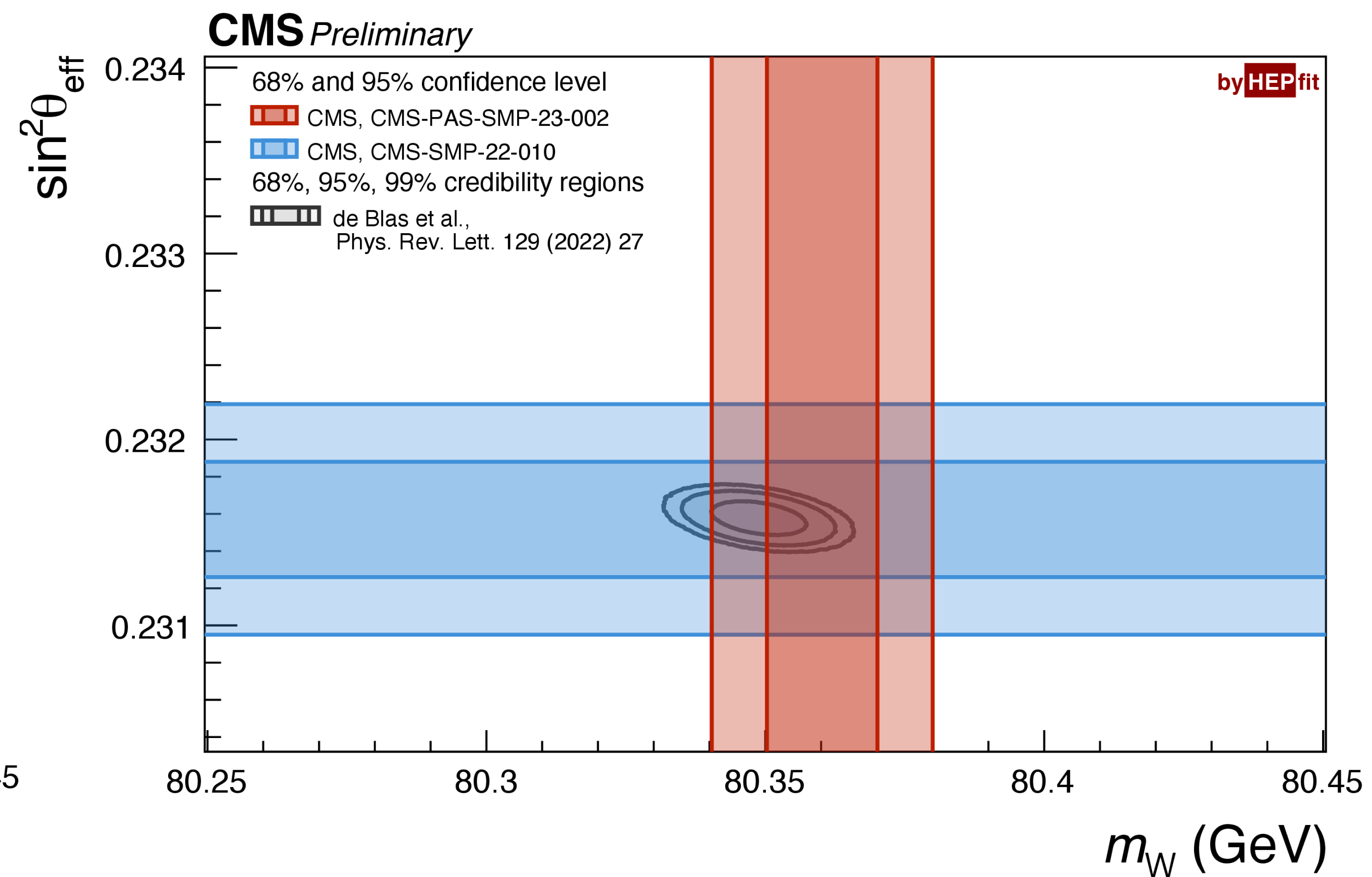
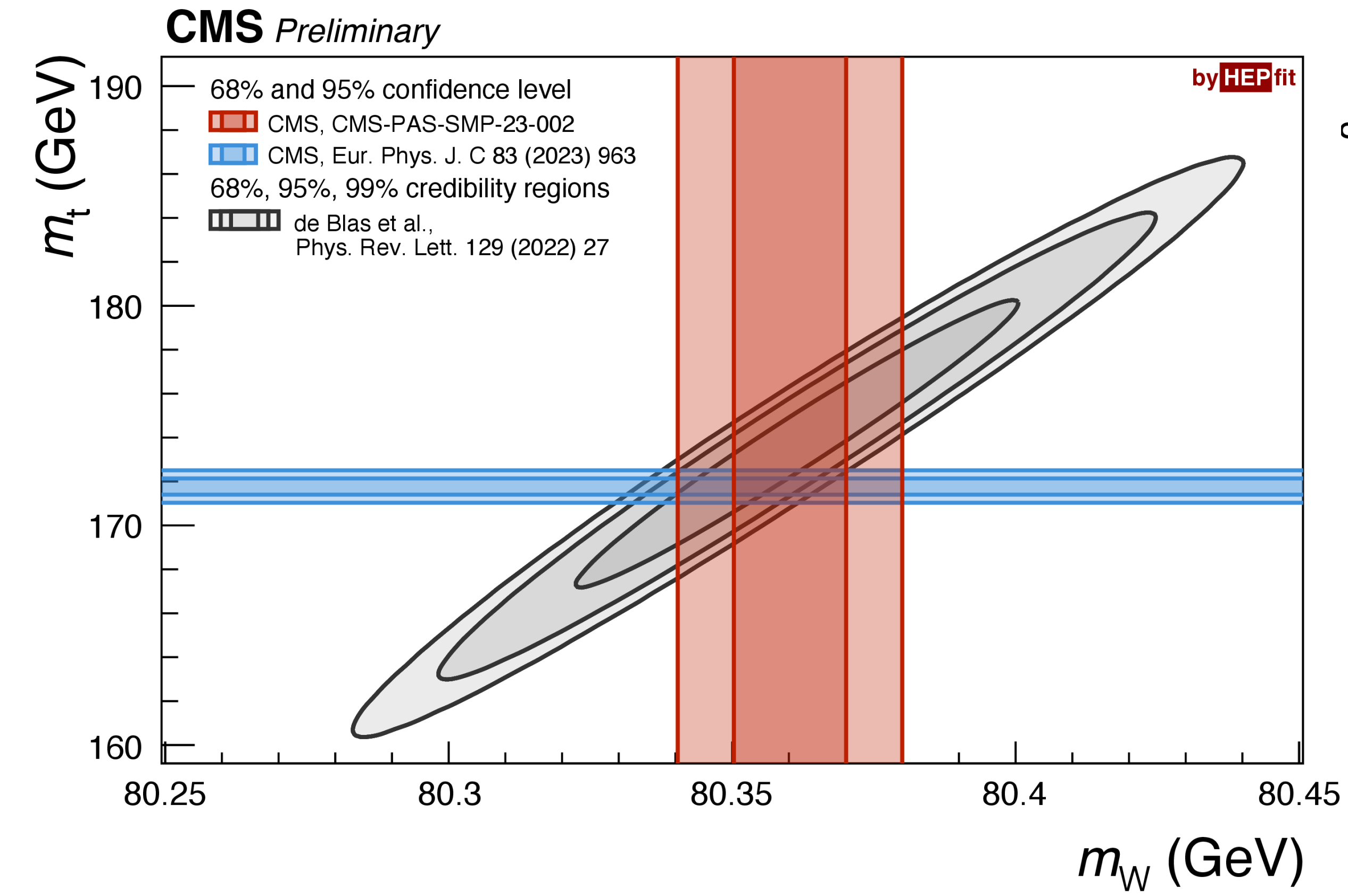

Summary and conclusions

- The first m_W measurement at CMS is a long-awaited milestone for precision physics at the LHC
 - Documented in [CMS-PAS-SMP-23-002](#), submission to journal very shortly
 - Most precise measurement at LHC
 - In tension with CDF measurement
- The CMS detector and the LHC are precision instruments, far exceeding expectations

'The standard model is not dead': ultra-precise particle measurement thrills physicists

CERN's calculation of the W boson's mass agrees with theory, contradicting a previous anomaly that had raised the possibility of new physics.

By [Elizabeth Gibney](#)

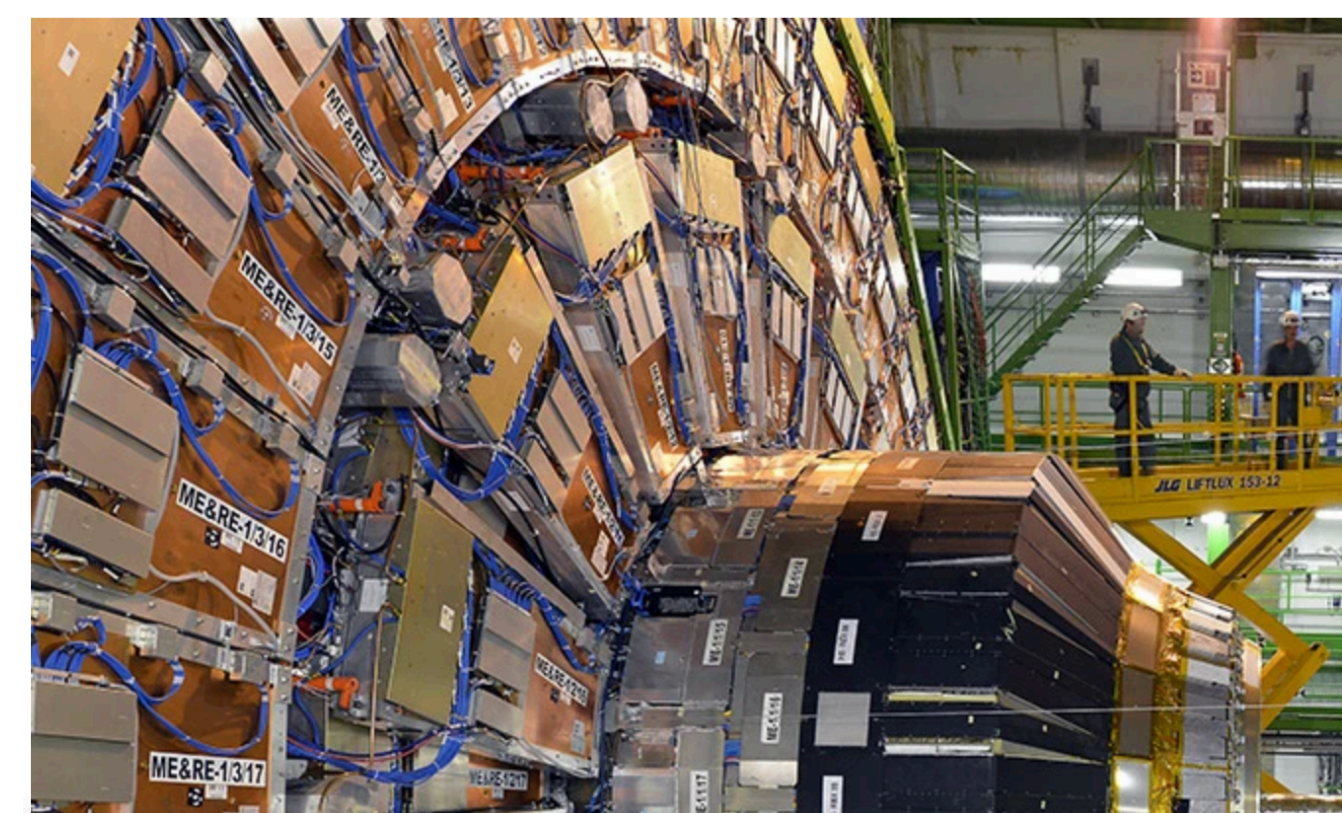

LEP combination
 Phys. Rep. 532 (2013) 119
D0
 PRL 108 (2012) 151804
CDF
 Science 376 (2022) 6589
LHCb
 JHEP 01 (2022) 036
ATLAS
 arxiv:2403.15085, subm. to EPJC
CMS
 This Work

CMS Preliminary

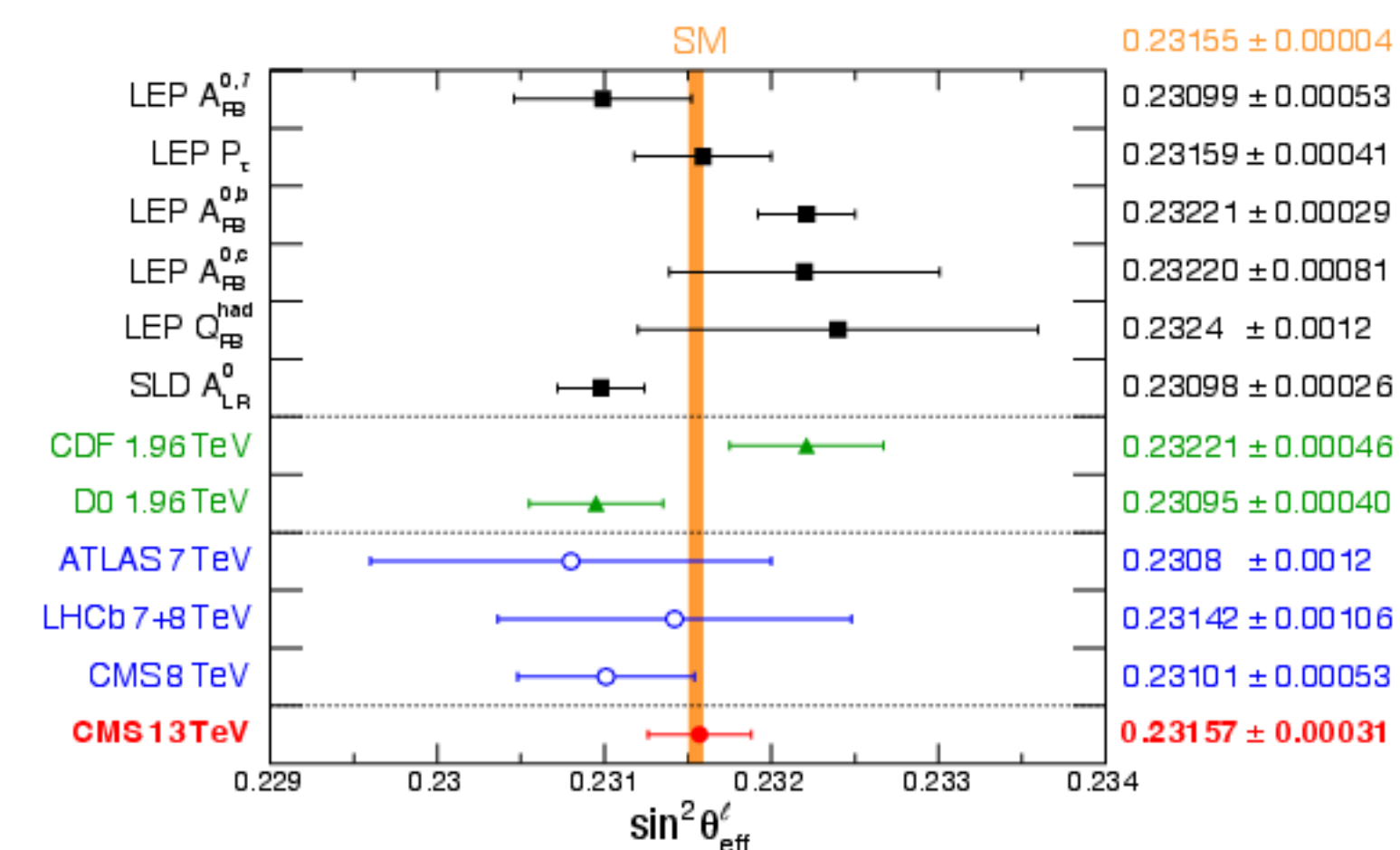
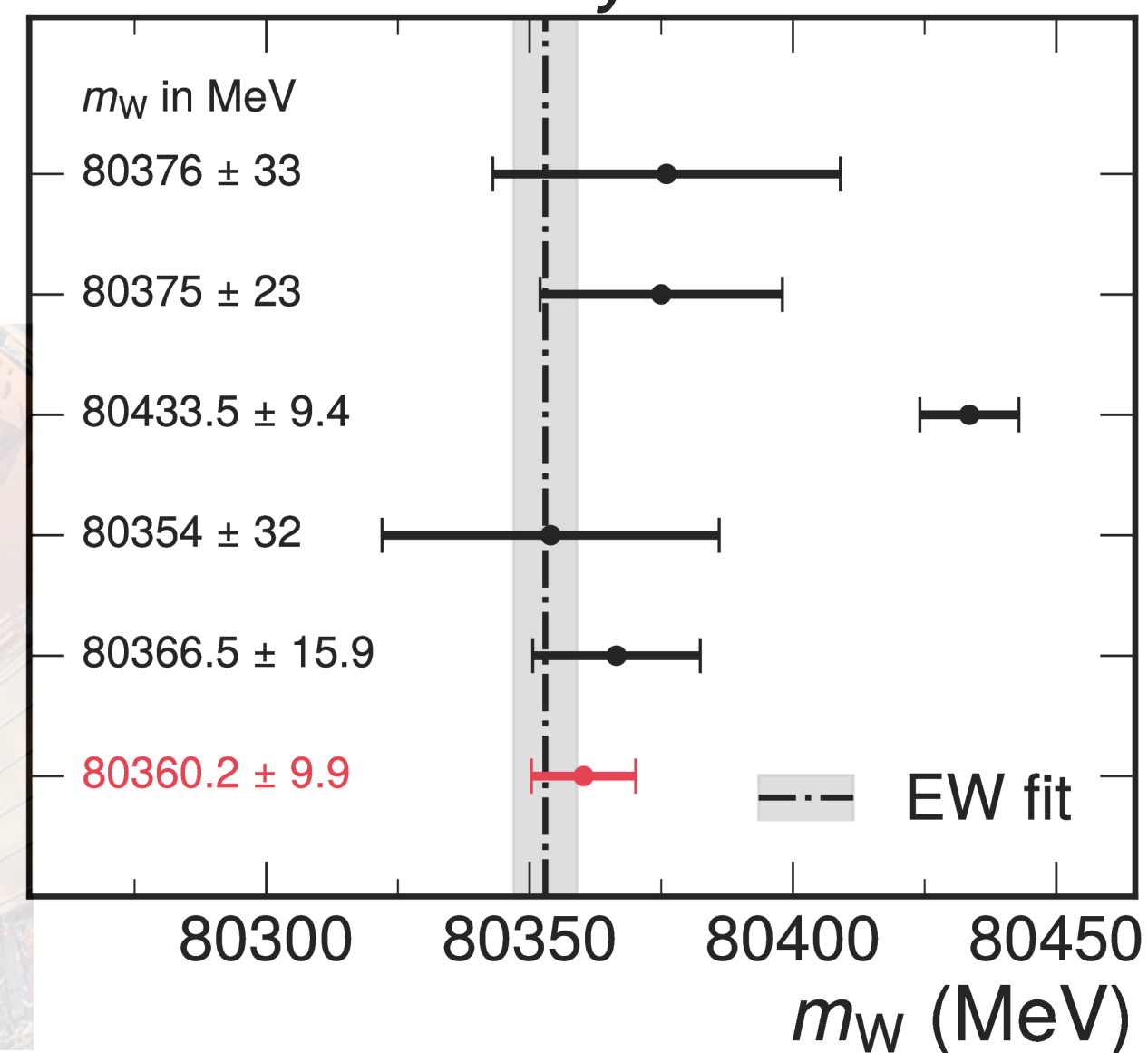



Backup

Looking forward

- In the near (and not so near) future, **hadron colliders are our main probe of m_W**
 - Can envision huge theoretical progress in next 20 years
 - Enormous data set will come with increased experimental challenges due to high-pileup and detector aging
 - Mitigate with special runs, detector upgrades, reconstruction advancements
- Future e^+e^- collider provides more direct, less theory-dependent measurement from threshold scans
 - FCC-ee anticipates < 1 MeV unc. in m_W
- Experimental+theory hadron collider communities must meet the challenge of providing results that stand the test of time
- Publish/maintain analyses that can be reinterpreted with improved theory

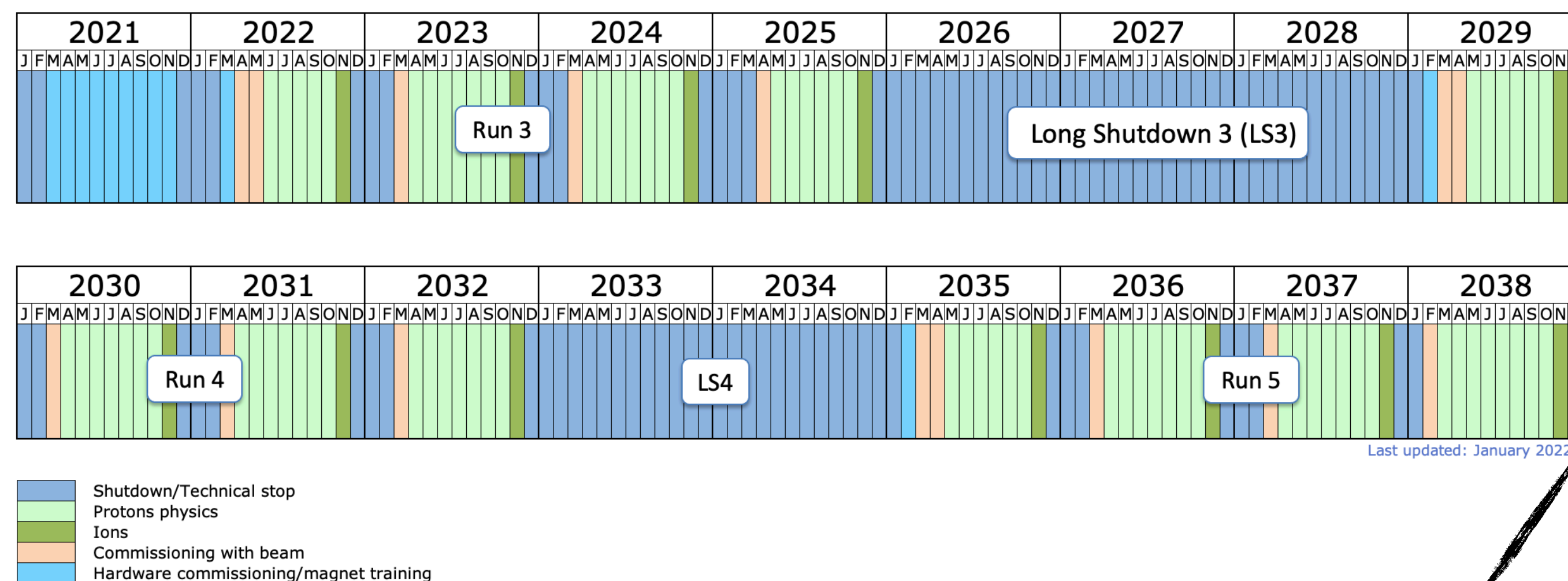

FCC-ee?

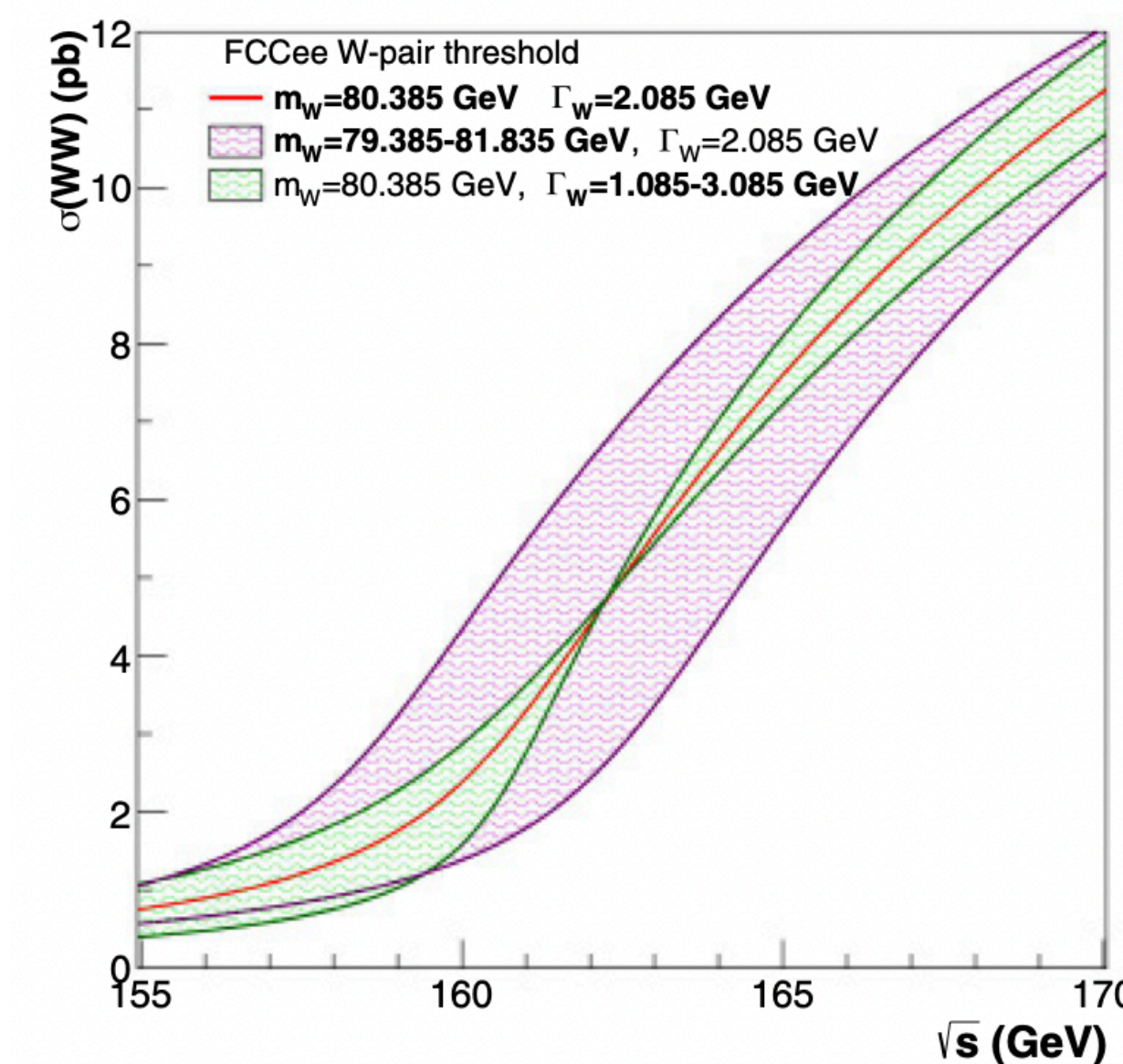

- Only “global” uncertainty breakdown ([arxiv:2307.04007](https://arxiv.org/abs/2307.04007)) comparable to ATLAS

Unc. [MeV]	Total	Stat.	Syst.	PDF	A_i	Backg.	EW	e	μ	u_T	Lumi	Γ_W	PS
p_T^ℓ	16.2	11.1	11.8	4.9	3.5	1.7	5.6	5.9	5.4	0.9	1.1	0.1	1.5
m_T	24.4	11.4	21.6	11.7	4.7	4.1	4.9	6.7	6.0	11.4	2.5	0.2	7.0
Combined	15.9	9.8	12.5	5.7	3.7	2.0	5.4	6.0	5.4	2.3	1.3	0.1	2.3

ATLAS

Source	Uncertainty (MeV)
Lepton energy scale	3.0
Lepton energy resolution	1.2
Recoil energy scale	1.2
Recoil energy resolution	1.8
Lepton efficiency	0.4
Lepton removal	1.2
Backgrounds	3.3
p_T^Z model	1.8
p_T^W/p_T^Z model	1.3
Parton distributions	3.9
QED radiation	2.7
W boson statistics	6.4
Total	9.4

Compared to ATLAS

- Leverage larger data set while managing comparable exp. uncertainties in high PU
- Stronger constraints on PDFs
- Reduced impact of other theory
 - ATLAS EW unc. due to use of older Photos++
- Total calibration + muon eff. only 10% better
 - but Z-independent, model-based

CDF has advantages from $p\bar{p}$, lower E, PU

- PDFs better understood (valence quarks)
- Less hadronic activity (simpler recoil calibration)
- Low tracking material aids lepton calibration

➔ Much larger data set is the CMS saving grace

Source of uncertainty	Impact (MeV)	
	Nominal	Global
Muon momentum scale	4.8	4.4
Muon reco. efficiency	3.0	2.3
W and Z angular coeffs.	3.3	3.0
Higher-order EW	2.0	1.9
p_T^V modeling	2.0	0.8
PDF	4.4	2.8
Nonprompt background	3.2	1.7
Integrated luminosity	0.1	0.1
MC sample size	1.5	3.8
Data sample size	2.4	6.0
Total uncertainty	9.9	9.9

CDF

CMS

Muon reconstruction efficiency

- First step of analysis is reconstructing muons very precisely
 - *in situ* measurement of reconstruction rate from $Z \rightarrow \mu\mu$ sample (tag-and-probe)
 - ϵ binned very finely in (p_T^μ, η^μ) and divided by into steps:
 - tracking, track+muon system match, ID, trigger, isolation
 - Smoothed in p_T^μ to reduce stat. fluctuations
 - ~2400 nuisance parameters in final signal extraction

➔ 3.0 MeV unc. in m_W

- Note: tag-and-probe cannot capture loss of events before the trigger, or differences between W and Z
 - Account for W/Z recoil differences
 - Custom vertex selection for W/Z consistency
 - Trigger “pre-firing” estimated independently

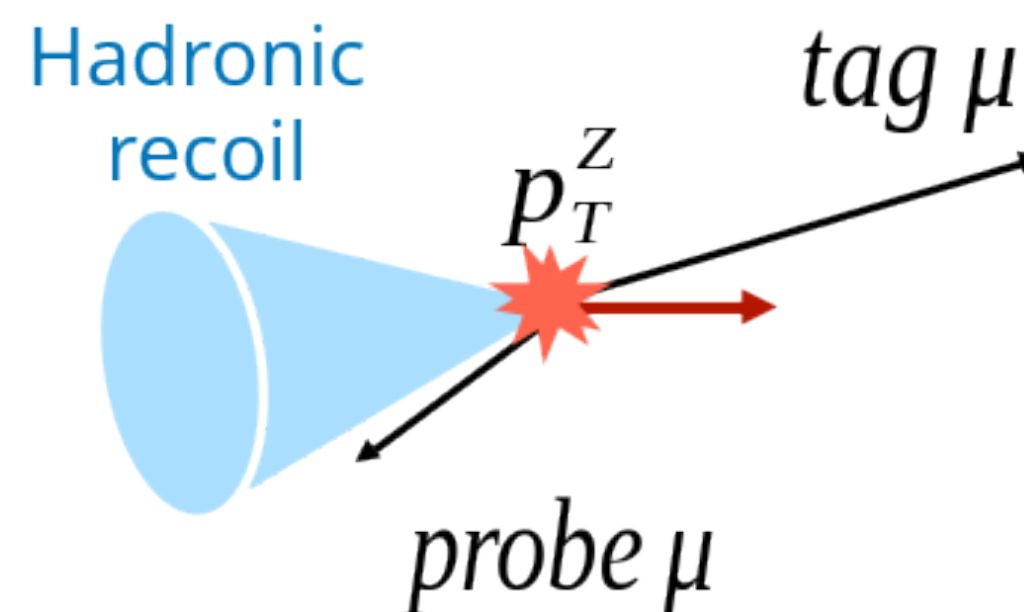

$$u_T = \frac{\vec{p}_T^\mu \cdot \vec{p}_T^Z}{p_T^\mu}$$

$$\epsilon = \frac{\text{passing probes}}{\text{passing probes} + \text{failing probes}}$$

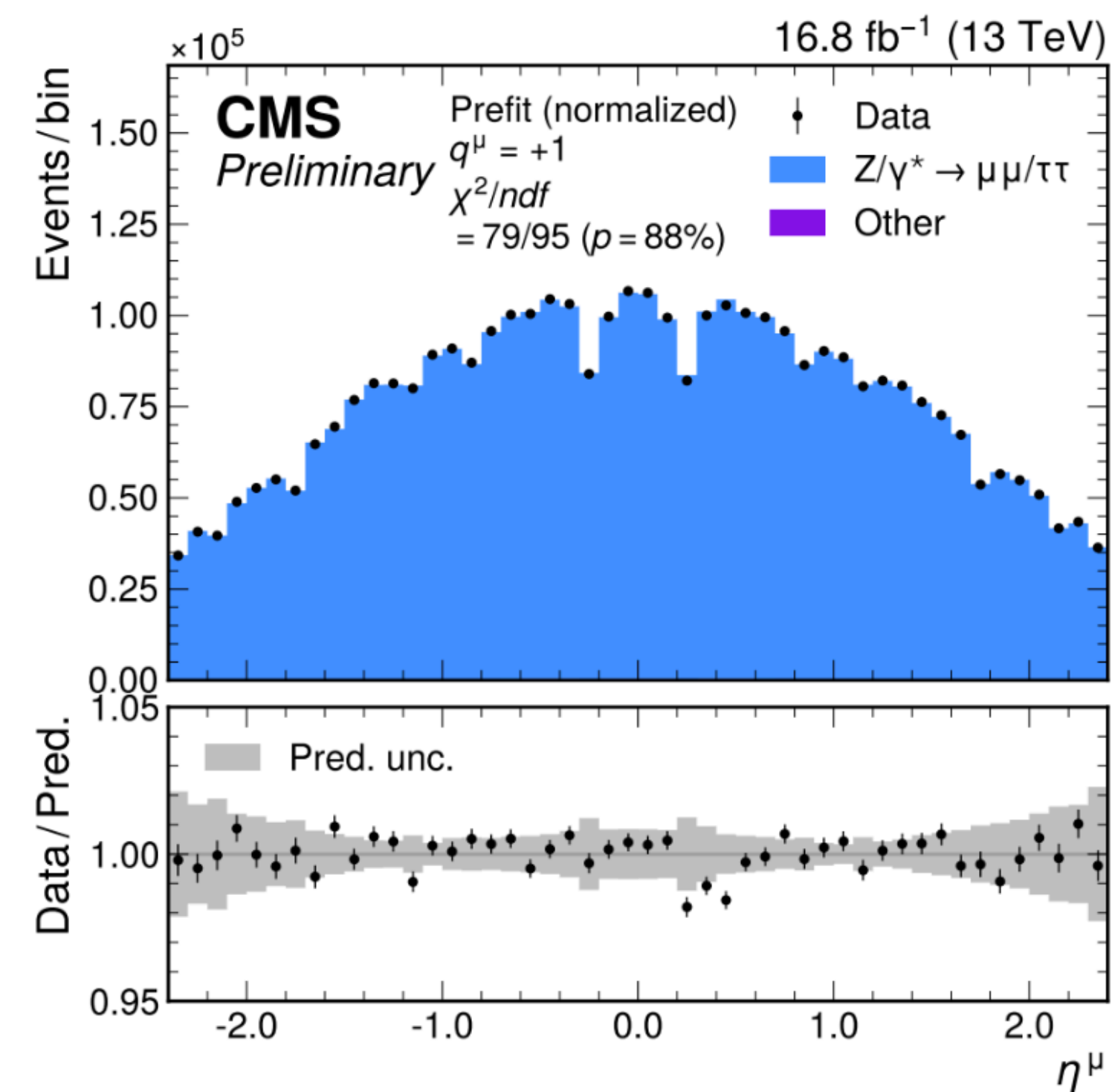

- p_T^{miss} enters the analysis via the signal ($m_T > 40$ GeV)
 - DeepMET gives improved resolution, better signal vs. background
- Calibrate p_T^{miss} in dimuon data
 - Hadronic activity must balance $p_T^{\ell\ell}$
 - Parameterised corrections in bins of boson p_T
 - Applied to Z (validation) and W MC using generator-level p_T^W

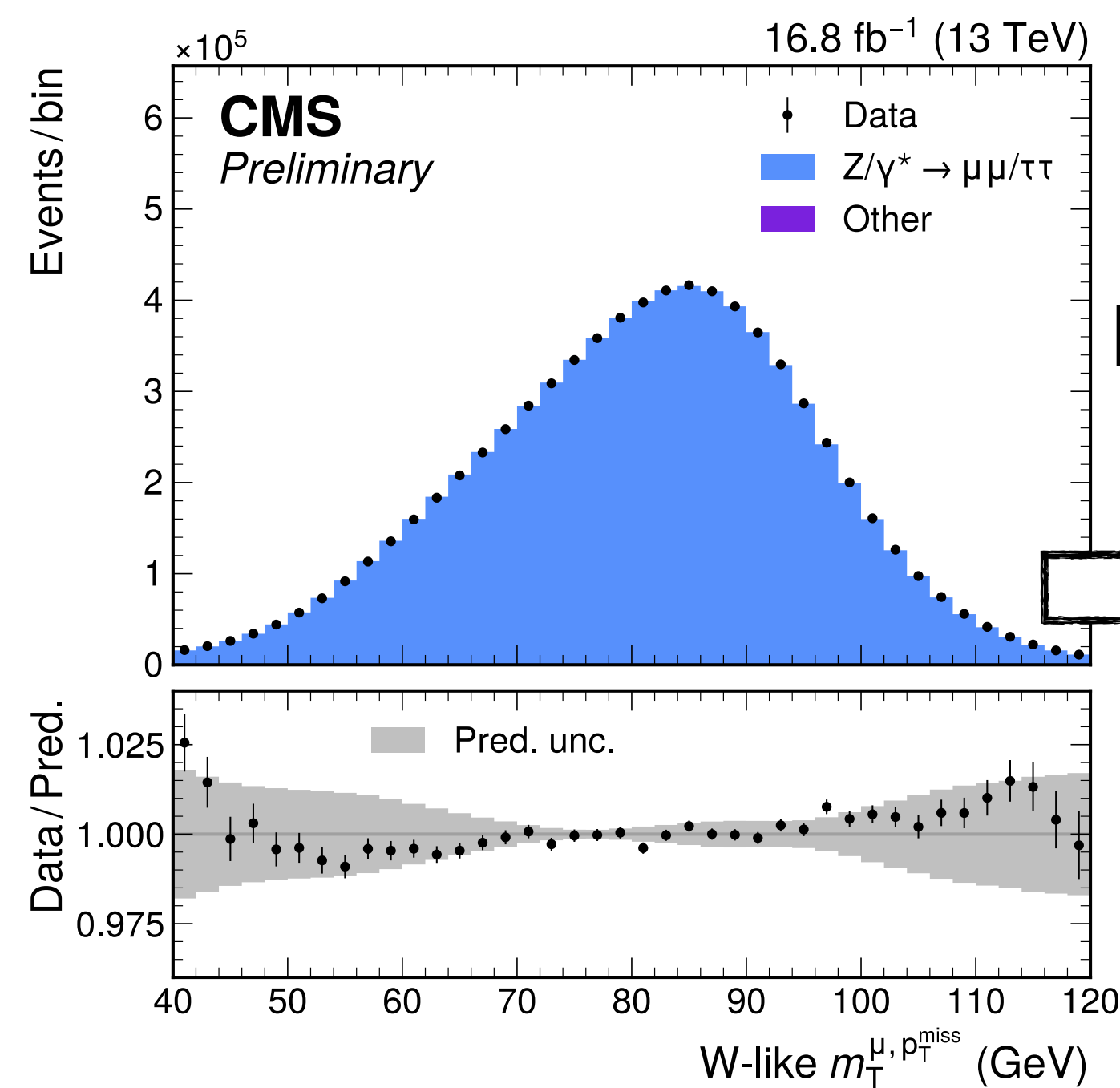
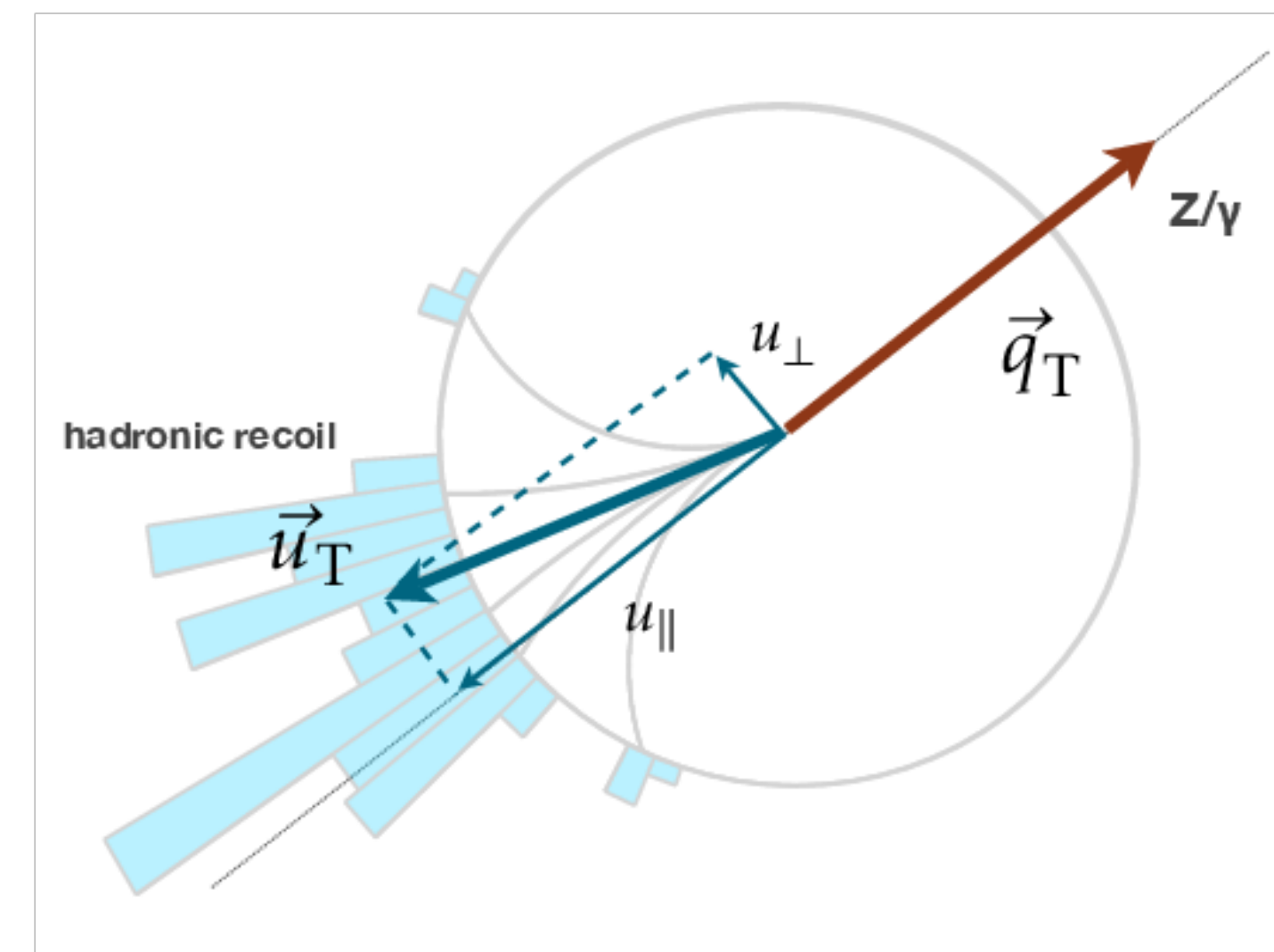

Derived from Z applied to W

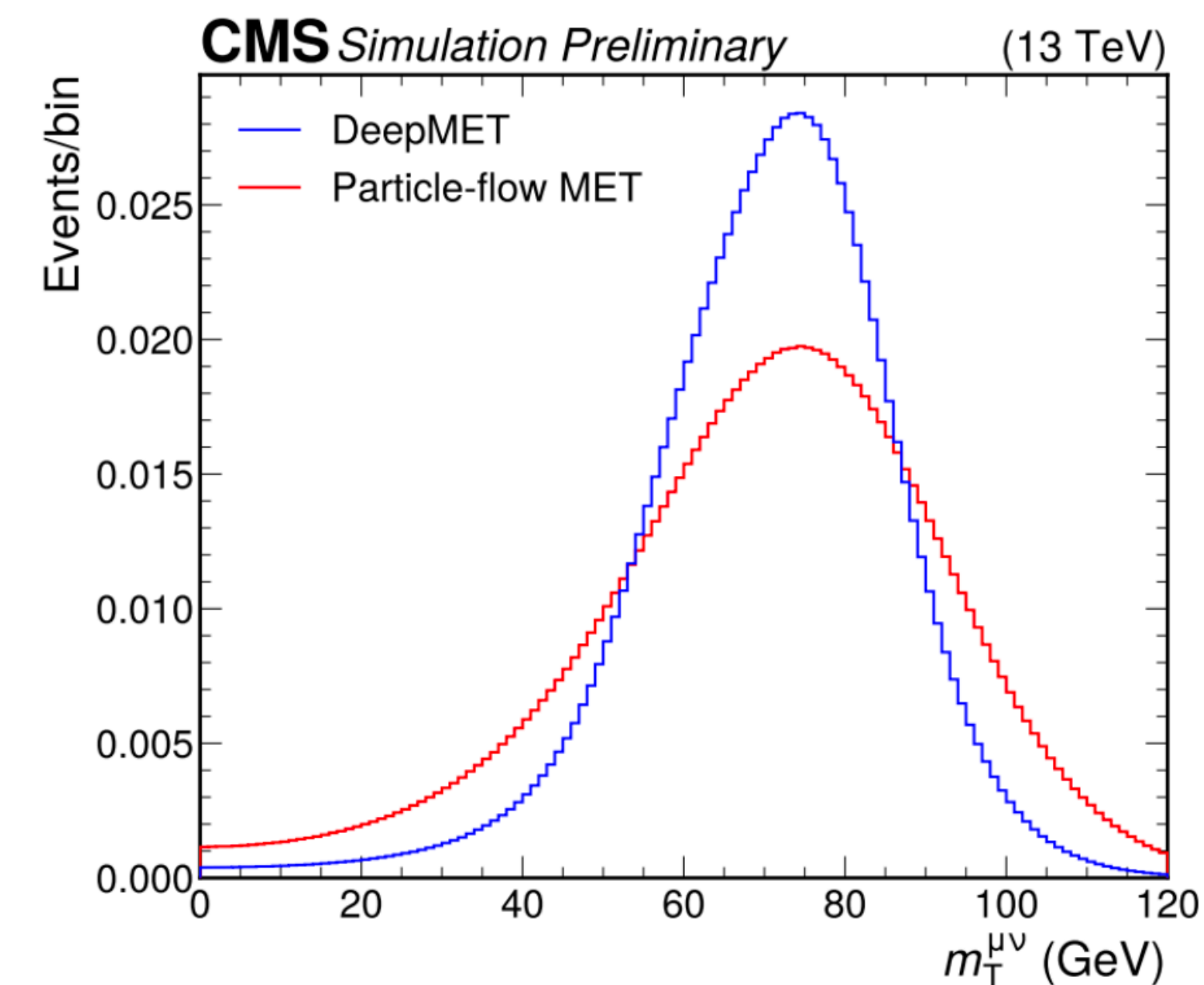
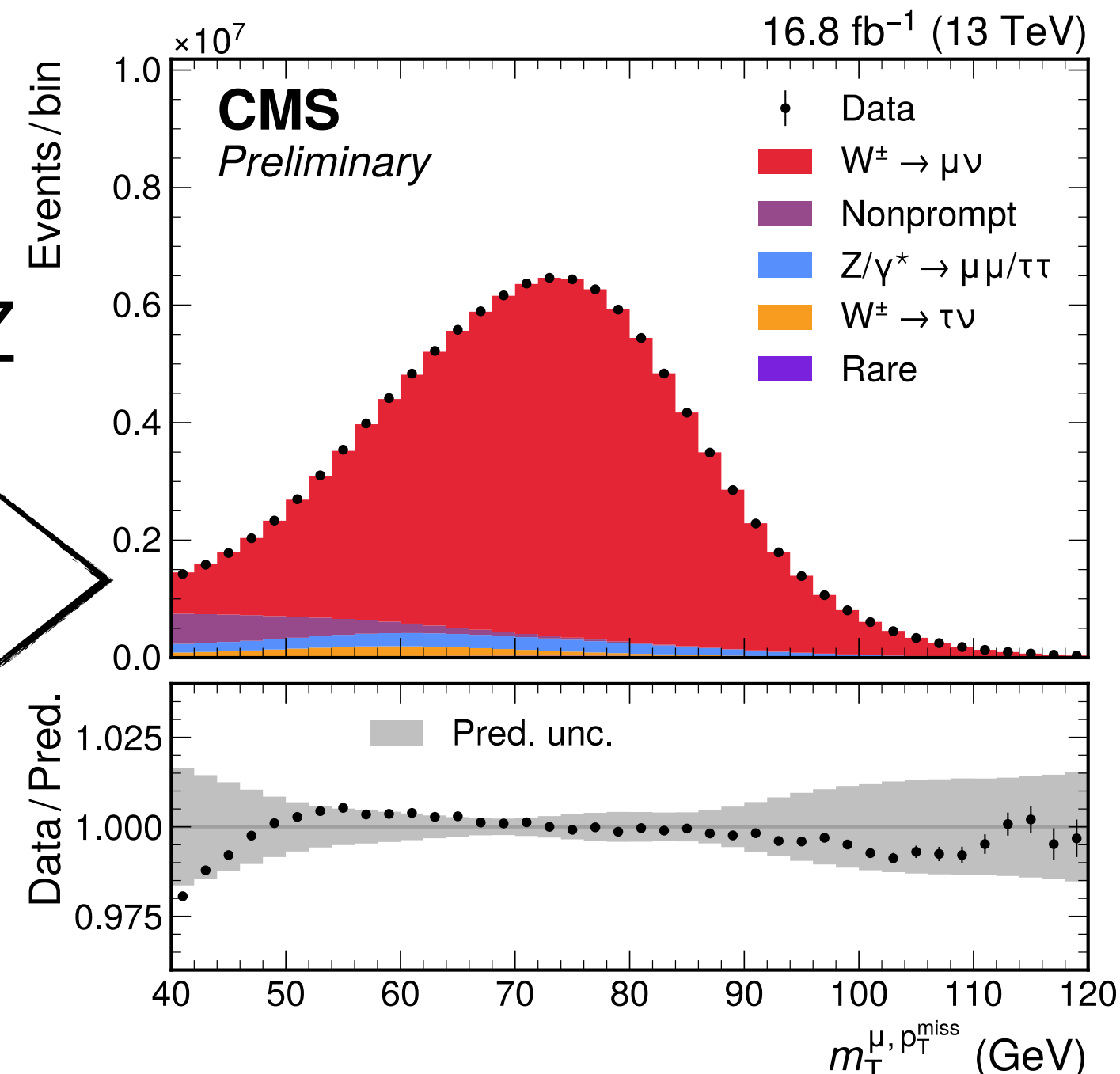

Nonprompt background estimation

- Data driven estimate with “extended ABCD method”
 - 5 (+1 signal) regions of isolation/ m_T to correct for correlations
 - Smoothing to reduce stat. fluctuations

➔ **3.2 MeV unc. in m_W**

- Full **uncertainties of prompt subtraction** propagated to 5 regions
 - Dedicated efficiency measurement for iso-failing muons

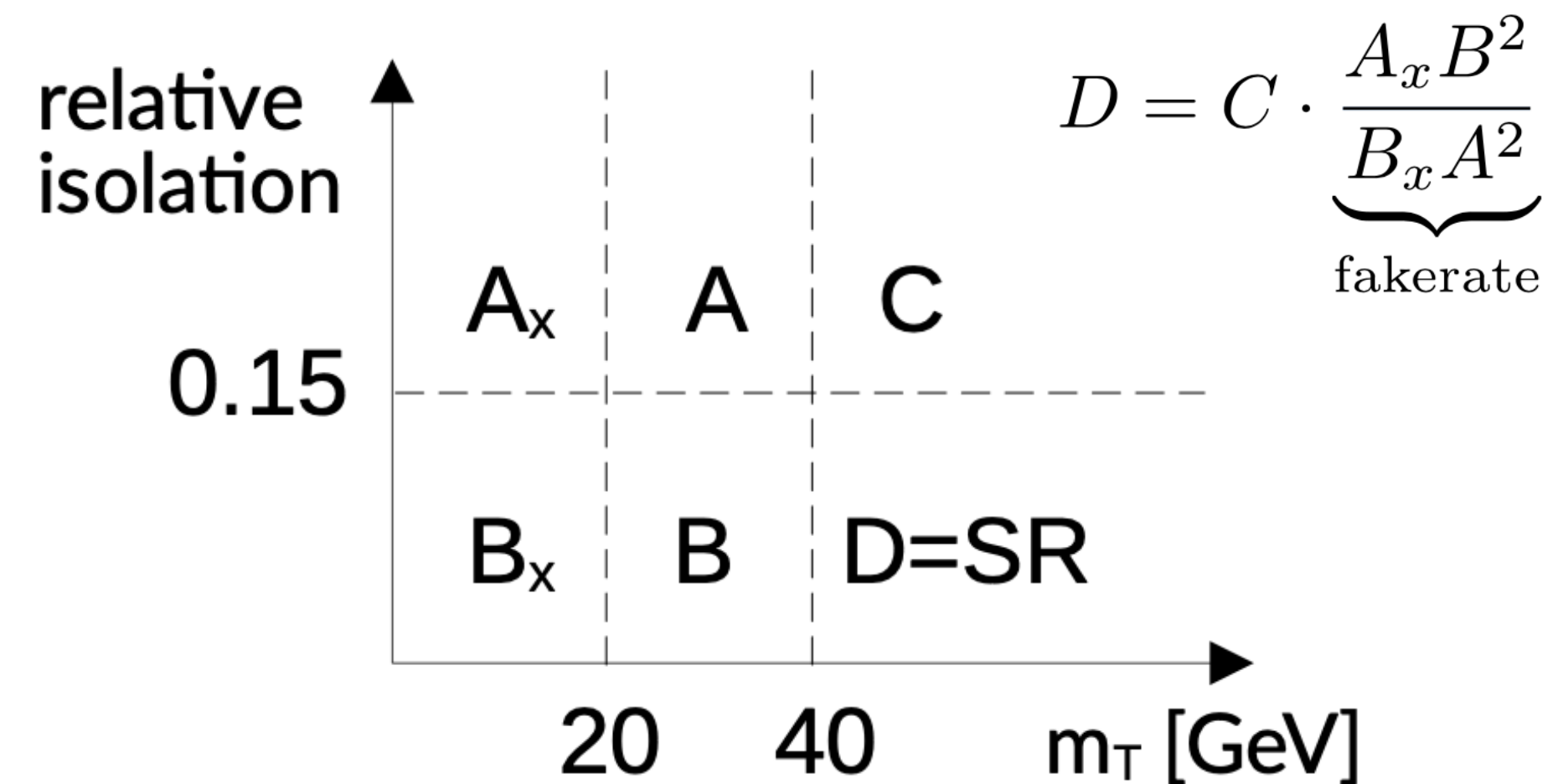

- Primarily heavy flavour decays to leptons in jets

➔ Validated in secondary vertex control region

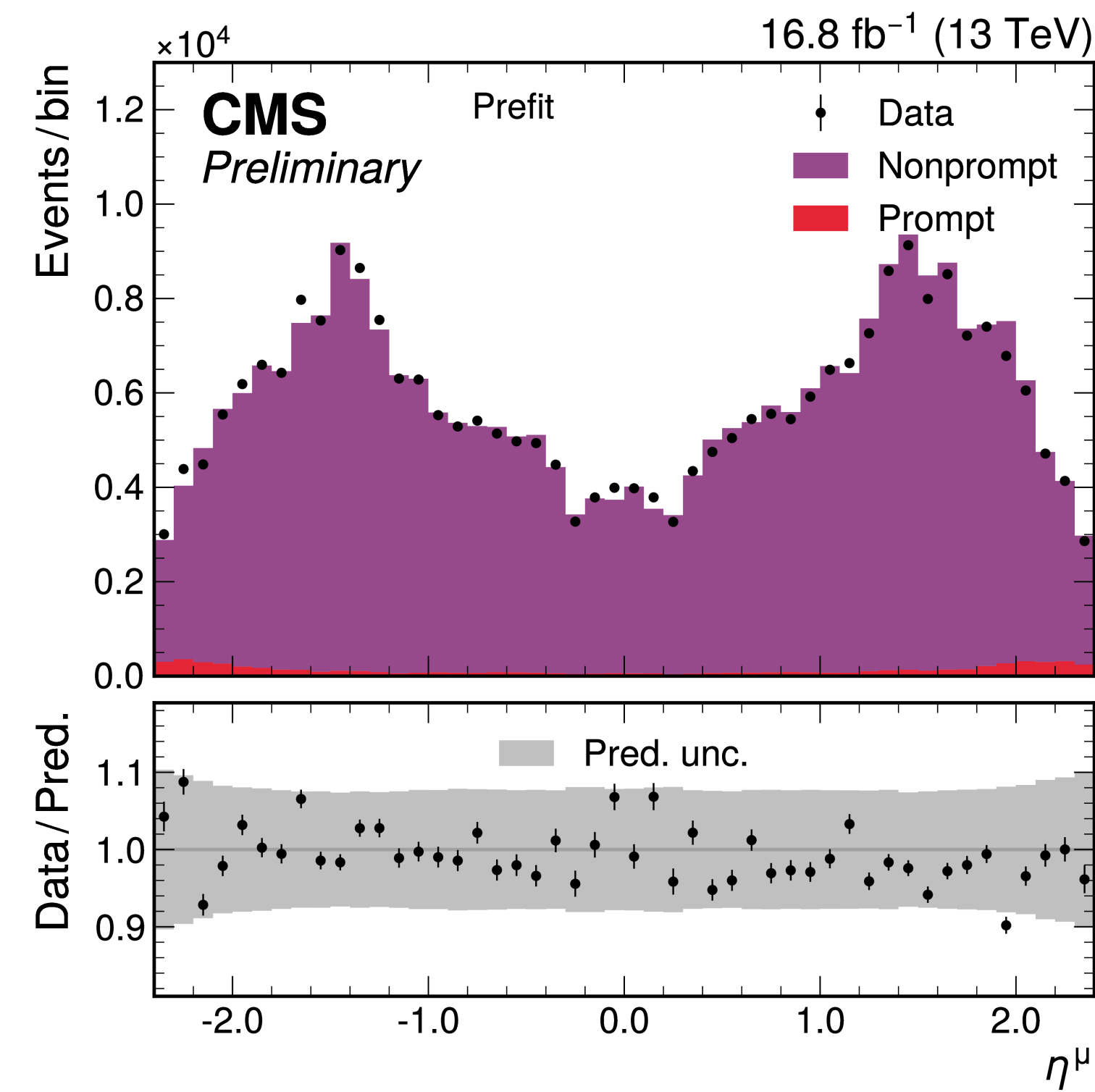
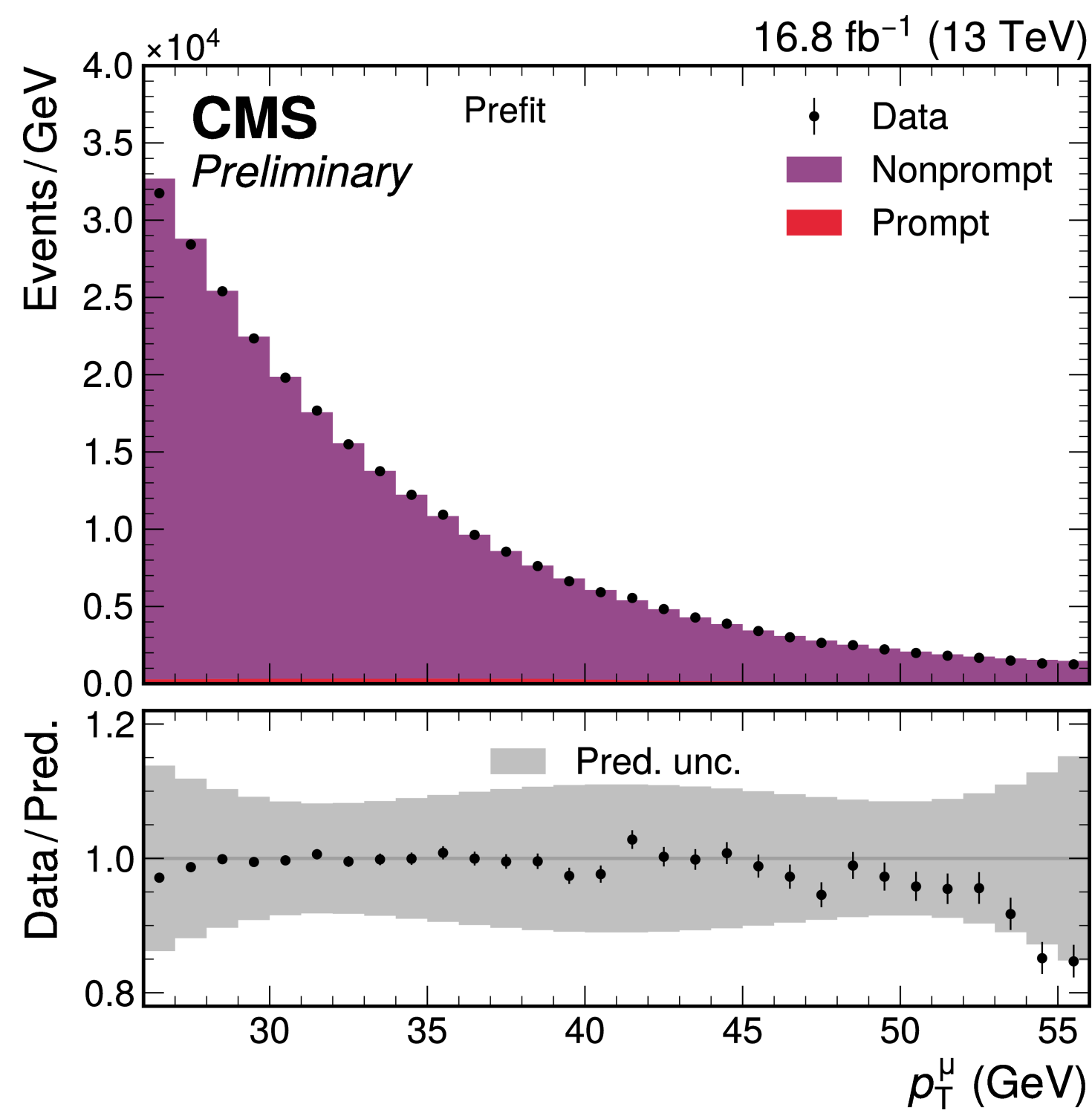

Higher-order EW uncertainties

- Main impact of EW corrections captured by Photos++
 - Includes QED @leading-log $\gamma \rightarrow ee/\mu\mu$ pair production and matrix element corrections (MEC) ~NLO QED
- Impact of higher-order EW evaluated by comparisons of full NLO EW calculation to MiNNLO+photos prediction. Factorized
 - **FSR** ~ **0.3 MeV** in m_W
 - Horace QED FSR
 - Photos++ MEC off
 - **ISR** < **0.1 MeV**
 - Switching on/off QED ISR in pythia
 - **Virtual** ~ **1.9 MeV**
 - Z: Powheg NLO+HO EW
 - W: ReneSANCe NLO+HO EW

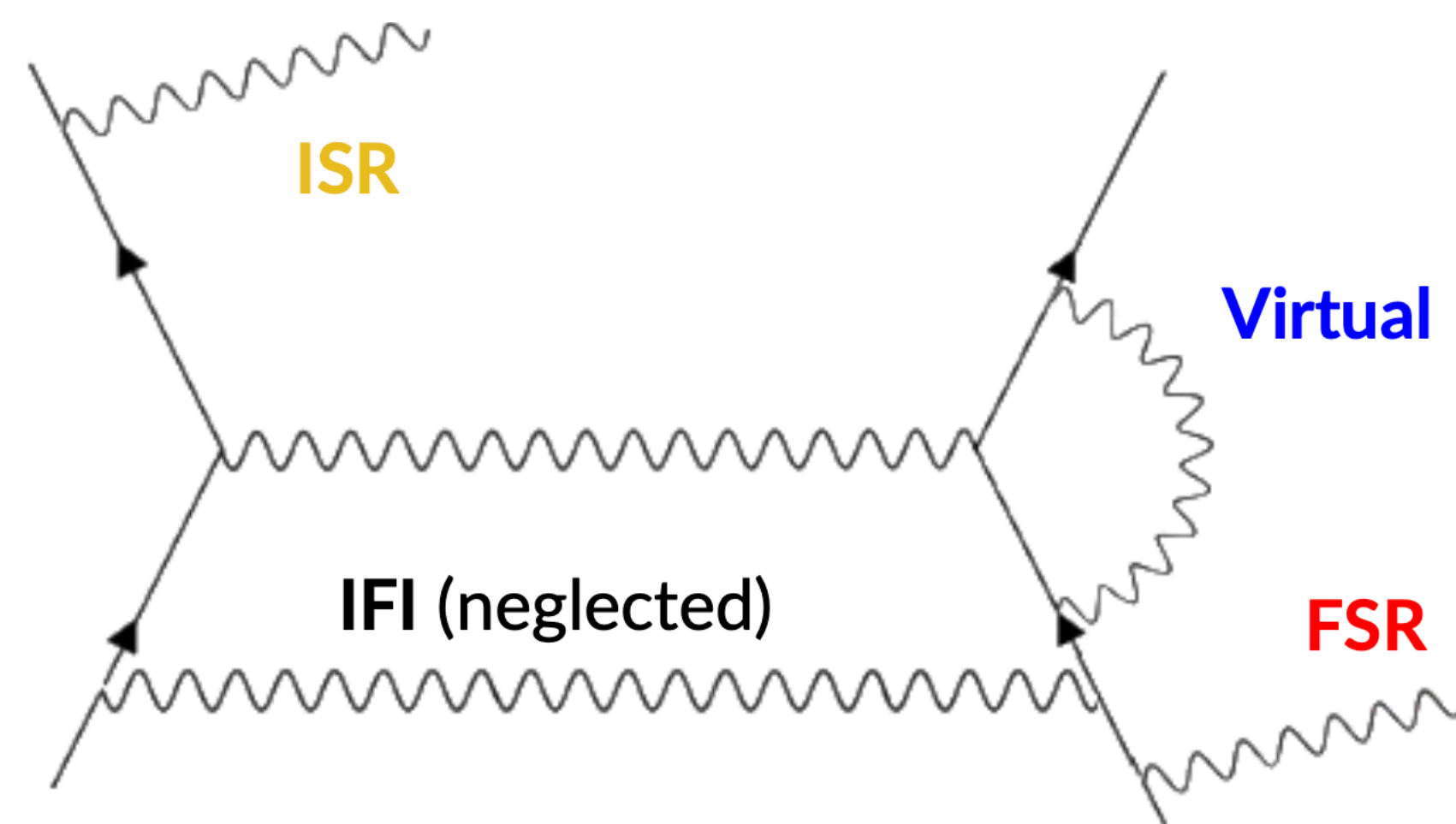
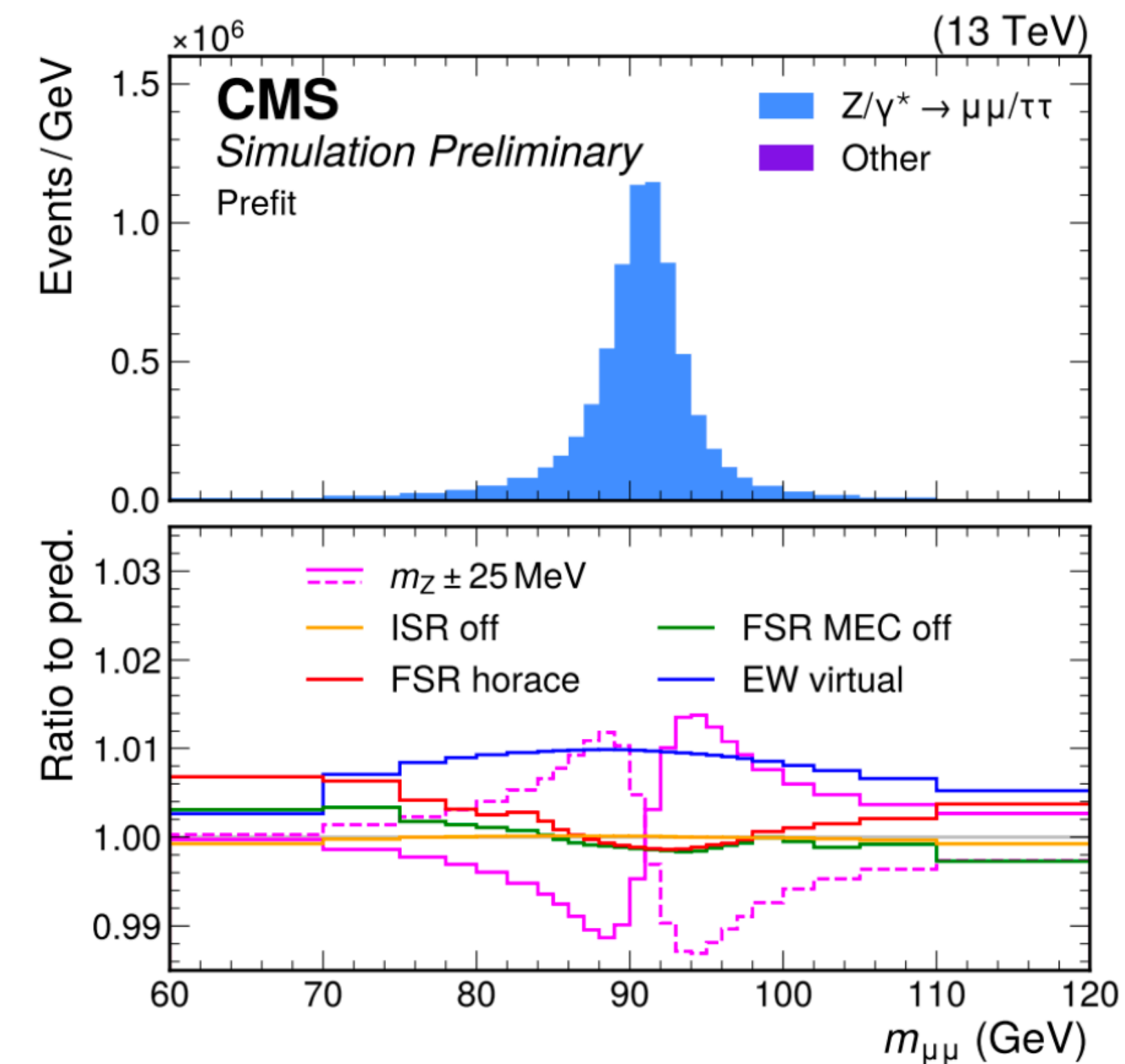

ATLAS: Pythia vs. Photos (6 MeV unc.)
 CDF: 2.7 MeV unc. (Horace)

Parameter level view of the theory model

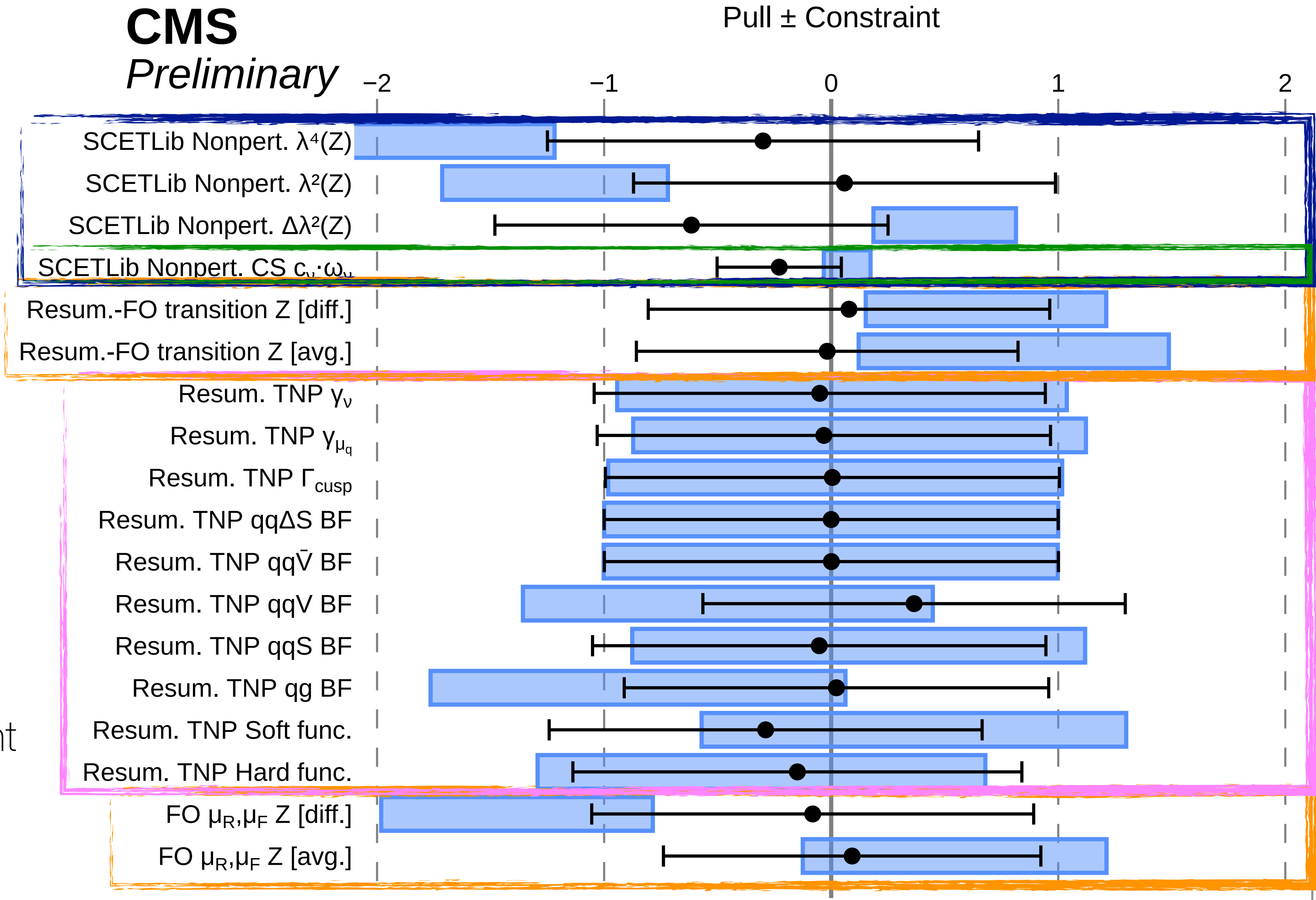
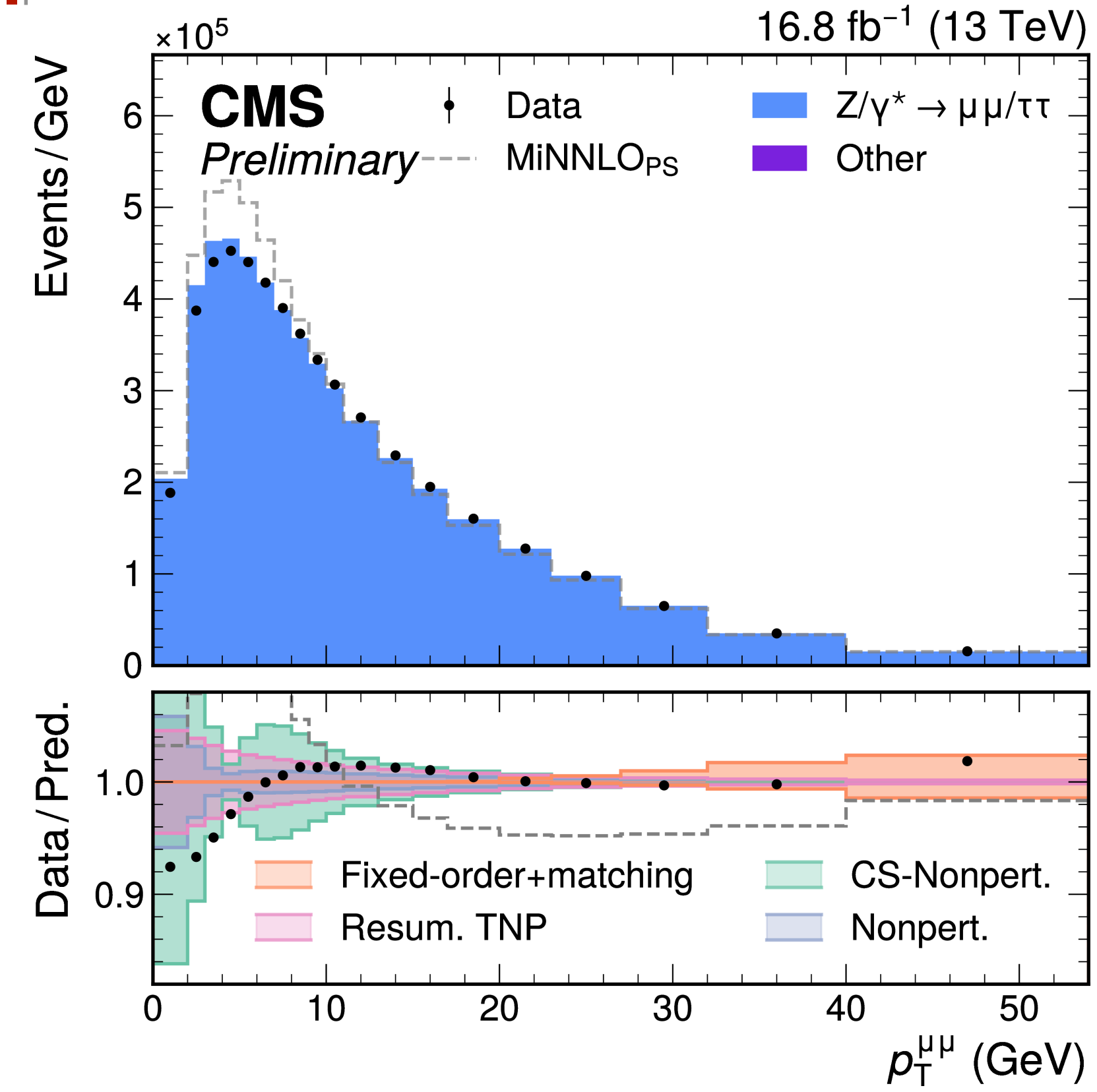

- Small pulls/constraints on TNPs
- Nonperturbative terms most important
 - Different behaviour of λ⁽²⁾ and CS terms due to degeneracy
- **Consistent impact on p_T^Z**

● m_Z (p_T^μ, η^μ, q^μ) fit ■ (p_T^{μμ}, y^{μμ}) fit

- **LEP combination (2013): 33 MeV unc.**
 - Semi-leptonic and fully hadronic WW decays
- **Tevatron (proton-antiproton):**
 - wrt LHC: Smaller W production uncertainty, better estimation of neutrino momentum
- **D0 (2013): (23 MeV unc.)**
- **CDF (2022): (9.4 MeV unc.)**
 - m_{T+pt^ℓ} ($e+\mu$); very precise ℓ calibration; 4.2 M events
- **LHCb (2021) (32 MeV unc.)**
 - 13 TeV, p_{T^μ} channel only; 2.4 M events
- **ATLAS (15.9 MeV unc.)**
 - Published 2017, updated earlier this year
 - 7 TeV data, m_{T+pt^ℓ} ($e+\mu$, 3 η categories); 14 M events
 - Driven by p_{T^ℓ} channel (~90%)
- **CMS (9.9 MeV unc.)**
 - 13 TeV data, p_{T^ℓ} (μ only, 48 η categories); 100 M events

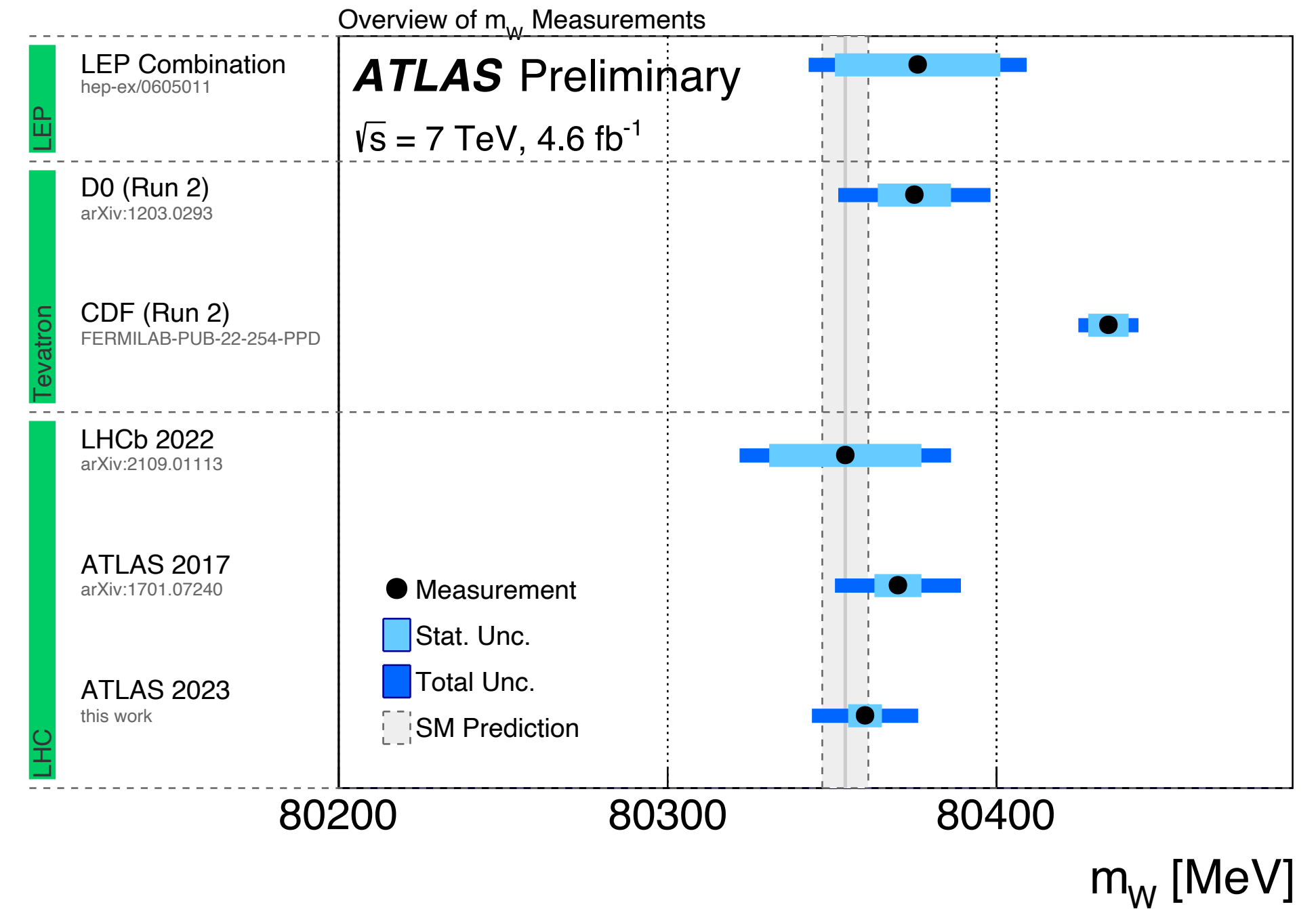

Source	Uncertainty (MeV)
Lepton energy scale	3.0
Lepton energy resolution	1.2
Recoil energy scale	1.2
Recoil energy resolution	1.8
Lepton efficiency	0.4
Lepton removal	1.2
Backgrounds	3.3
p_T^Z model	1.8
p_T^W/p_T^Z model	1.3
Parton distributions	3.9
QED radiation	2.7
W boson statistics	6.4
Total	9.4

CDF
uncertainty
breakdown

Comparison of measurements (previous ATLAS)

	ATLAS	LHCb	CDF
Collider	pp	pp	$p\bar{p}$
\sqrt{s}	7	13	1.96
\mathcal{L}	4.1–4.6	1.7	8.8
$N_{pileup} \sim$	9	2	3
Final states	e/μ	μ	e/μ
Fit variables	m_T, p_T^ℓ	$q/p_T^\ell, p_T^{\text{miss}}$	$m_T, p_T^\ell, p_T^{\text{miss}}$
$p_T^\ell > (\text{GeV})$	30	28	30
$p_T^\ell < (\text{GeV})$	50	52	55
$\eta^\ell >$	-2.5	2.2	-1.0
$\eta^\ell <$	2.5	4.4	1.0
$p_T^{\text{miss}} > (\text{GeV})$	30	N/A	30
$m_T > (\text{GeV})$	60	N/A	60
$m_T < (\text{GeV})$	100	N/A	100
$u_T < (\text{GeV})$	15	N/A	15
Selected events \sim	13.7M	2.4M	4.2M
MC generator	POWHEG-PYTHIA 8	POWHEG-PYTHIA 8	RESBOS
PDF set	NNPDF3.0	NNPDF3.1	NNPDF3.1

Comparison of uncertainties (previous ATLAS)

Source	ATLAS (MeV)	LHCb (MeV)	CDF (MeV)
Lepton uncertainties	9.2	10	3.5
Recoil energy scale & resolution	2.9	N/A	2.2
Backgrounds	4.5	2	3.3
Model theoretical uncertainties	9.9	17	3.5
PDFs	9.2	9	3.9
Statistical	6.8	23	6.4
Total	18.5	32	9.4

Pileup

- Multiple pp interactions in one LHC bunch crossing
 - Critical to the LHC push to high luminosity, but not “for free”
 - **“Is pileup really such a big deal?”** — Anonymous theory colleague
 - Most measurements: it’s worth the hit
 - Precision measurements: it’s a huge challenge!
- ➔ More stuff in the detector \Rightarrow more chances for confusion (e.g., tracks built from wrong hits), higher chance to mis-measure
- Balancing act between lumi. and performance

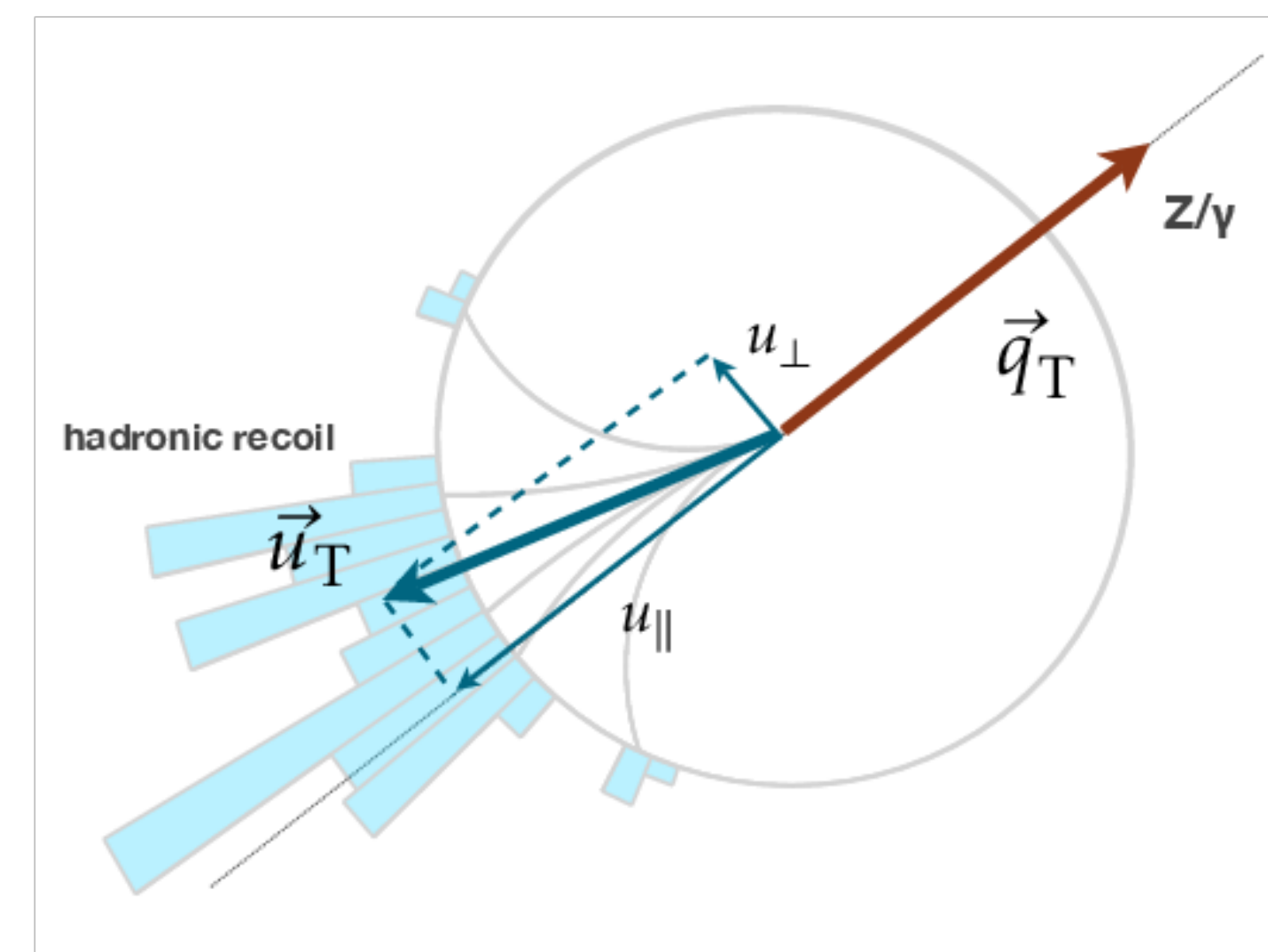
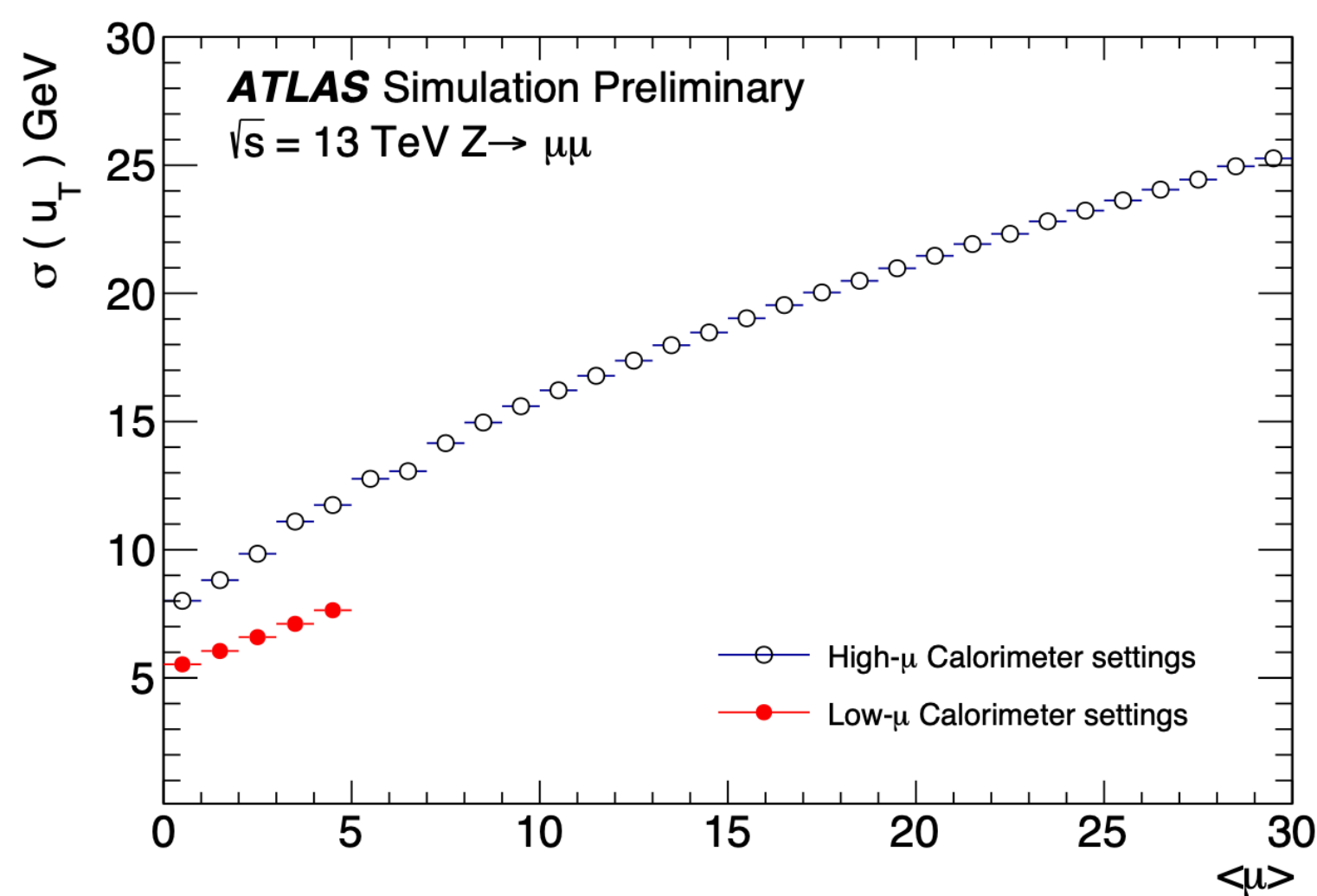
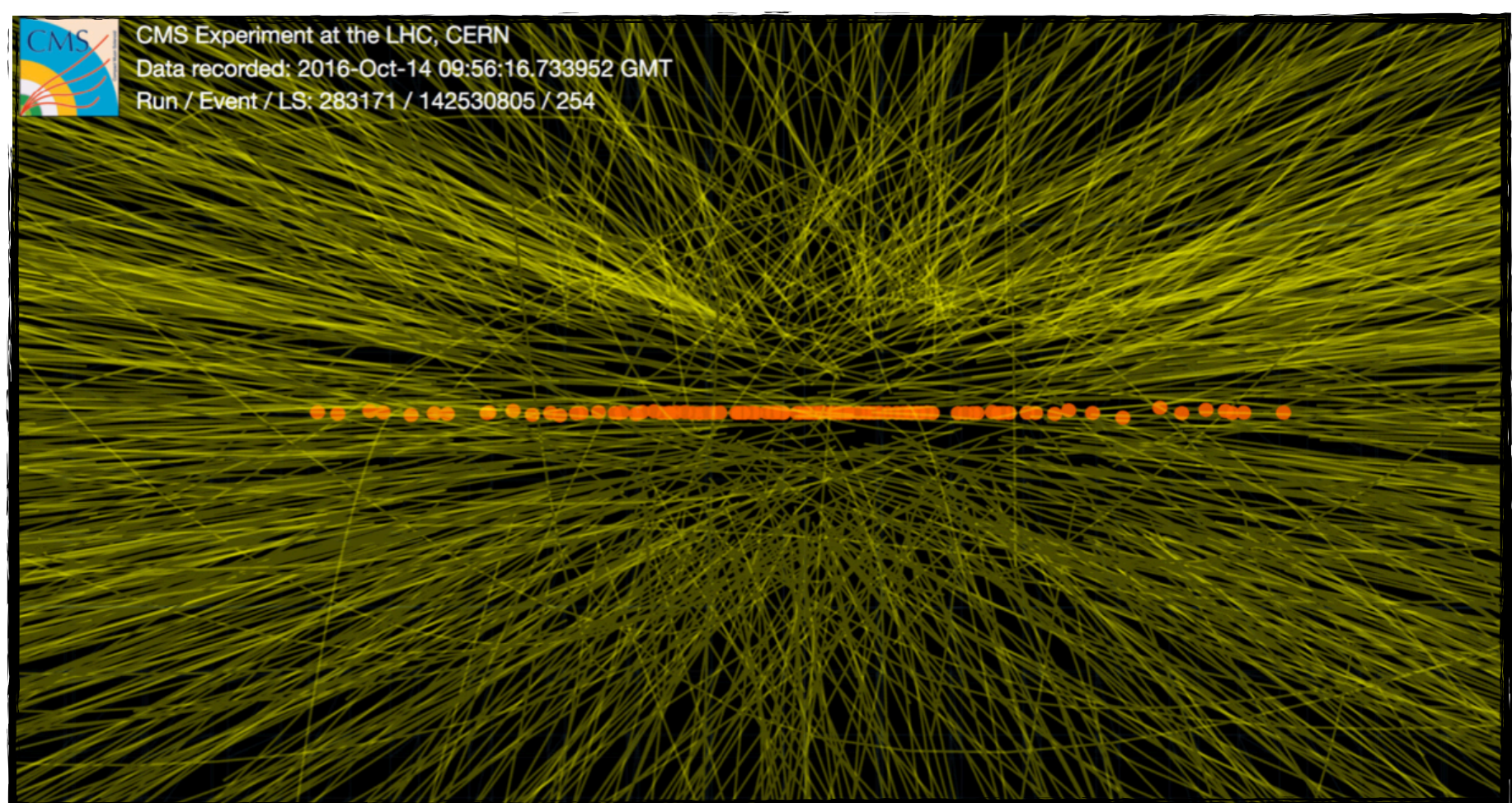
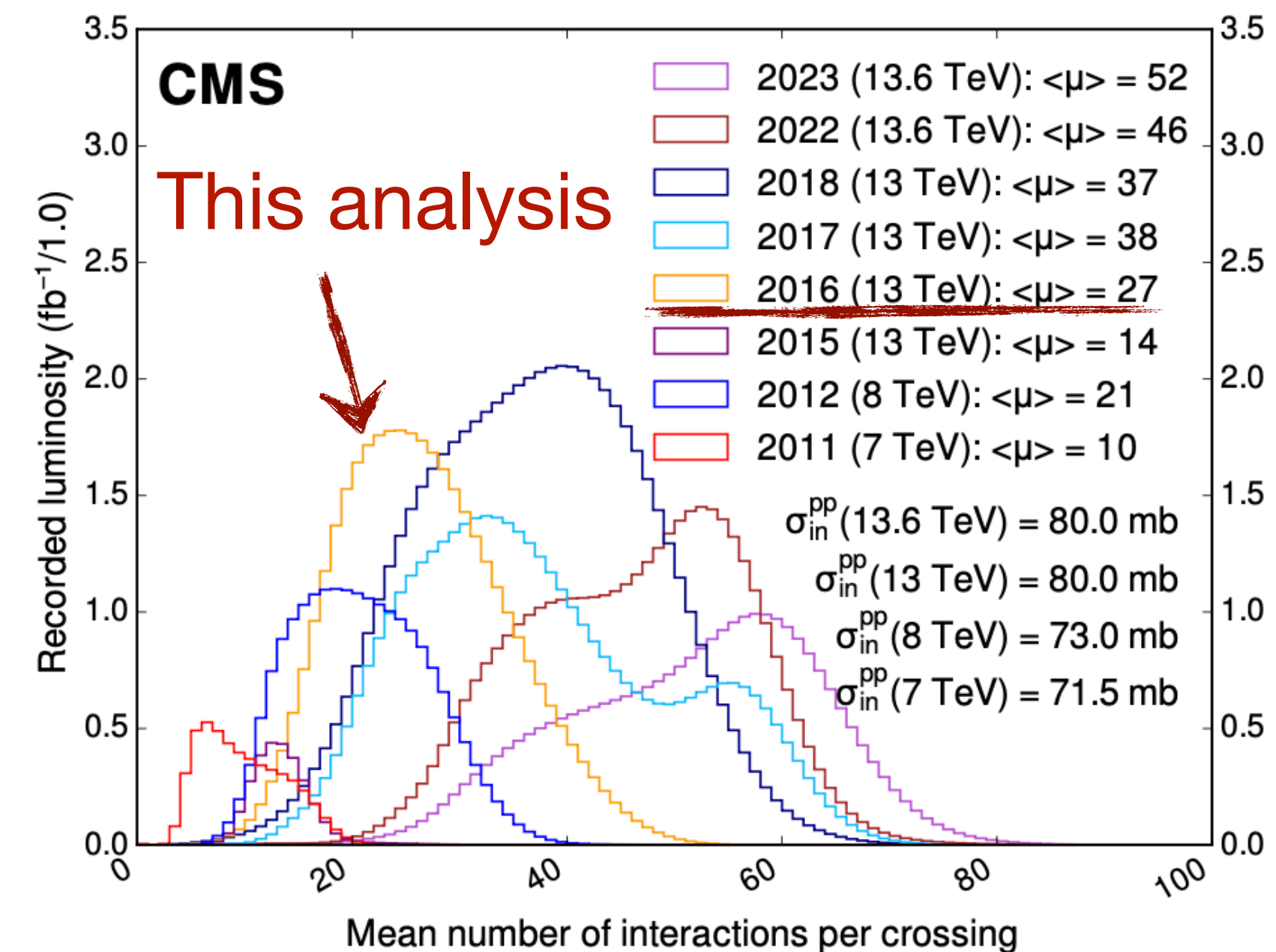

Theory nuisance parameters

- **Level 1:** At given order vary parameters around their known values

$$c_0 + \alpha_s(\mu) [c_1 + \alpha_s(\mu) c_2 + \dots] \rightarrow c_0 + \alpha_s(\mu) (c_1 + \tilde{\theta}_1)$$

- ▶ Simpler but perhaps less robust

- **Level 2:** Implement the full next order in terms of unknown parameters

$$c_0 + \alpha_s(\mu) [c_1 + \alpha_s(\mu) c_2 + \dots] \rightarrow c_0 + \alpha_s(\mu) [c_1 + \alpha_s(\mu) \theta_2]$$

- ▶ More involved, but also more robust, allowing for maximal precision

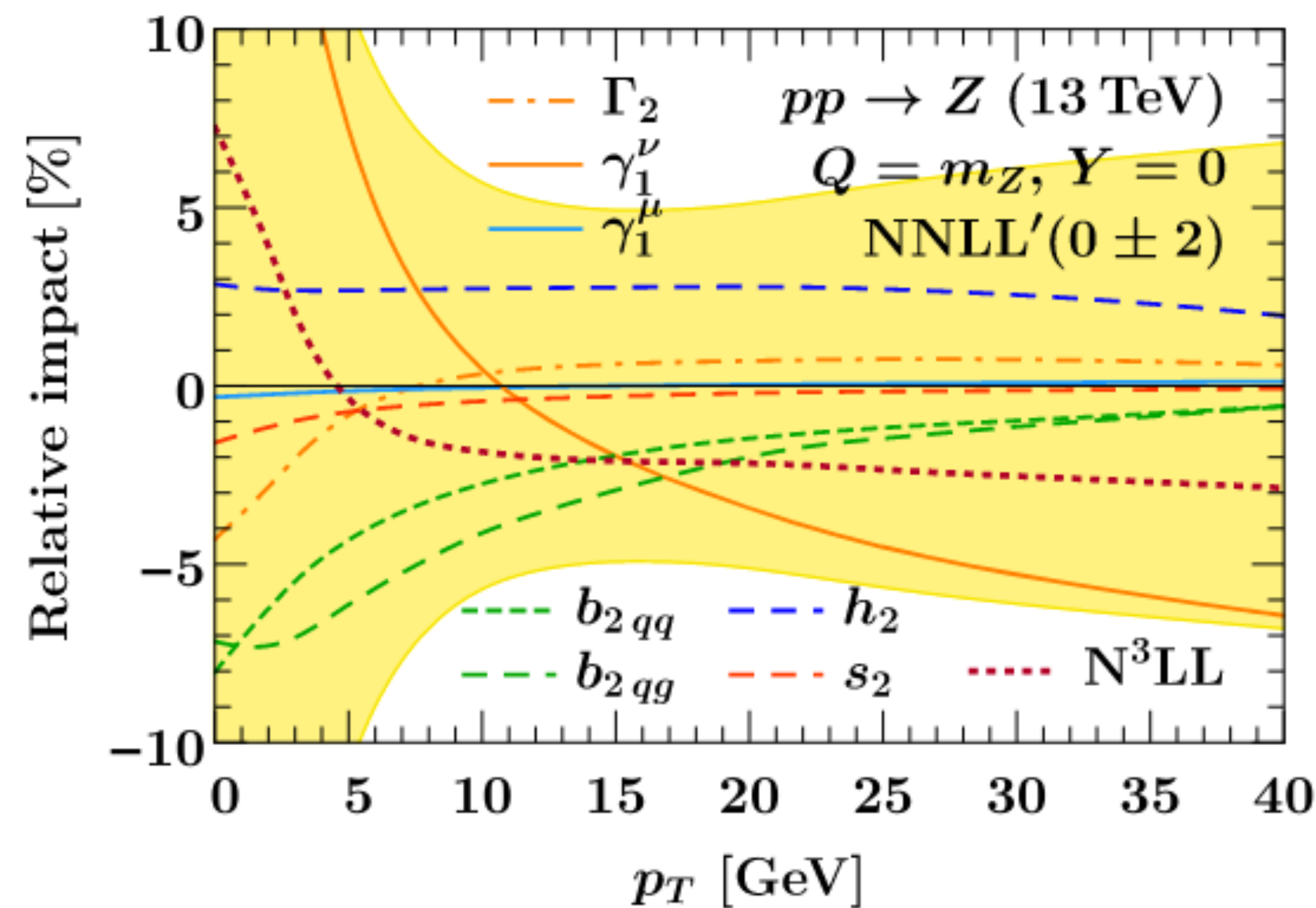

Statistical analysis

- Results from binned maximum likelihood fits to distributions sensitive to parameter-of-interest (m_W or m_Z)
 - **Using tensorflow-based** implementation of binned maximum likelihood fit
 - Avoid numerical instabilities due to fit complexities
- **O(3k) template bins in m_W fit and ~ 4000 nuisance parameters**
- **m_W (m_Z) uncertainty ± 100 MeV shift computed in simulation and propagated via event weights**
 - Unconstrained in fit
 - Extrapolation within range using log normal shape (validated to within < 0.1 MeV)
 - Consistent with typical χ^2 minimization
- **Measurement performed “blind”**
 - Likelihood fit with m_W only performed on data in final steps
 - m_Z and m_W values hidden, “unblinded” in sequence after finalising all inputs

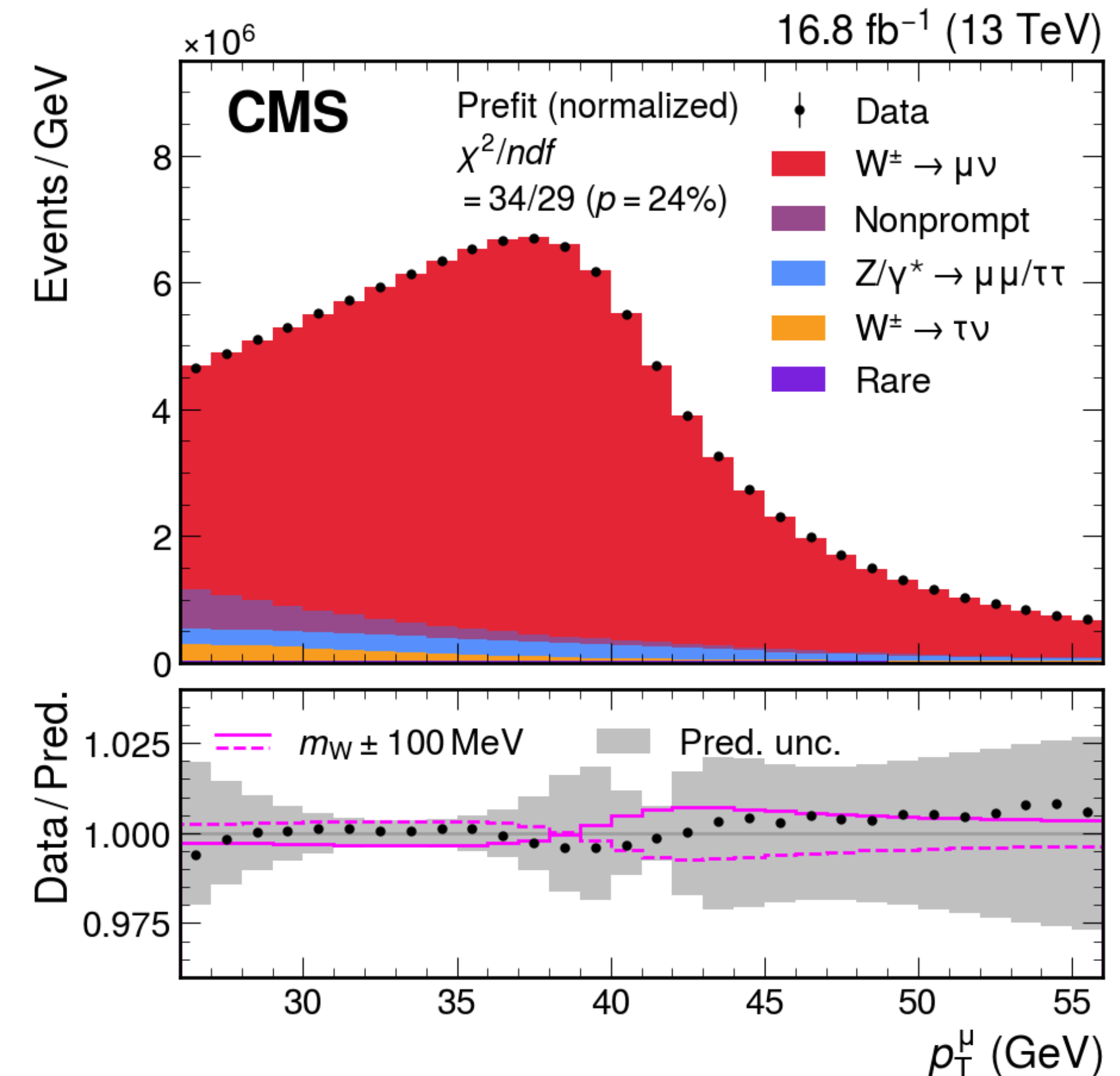

Heavy quark masses

- SCETlib calculation assumes massless quarks
 - Full calculation at comparable accuracy not known
- ➔ Estimate impact by varying quark mass thresholds in PDF (dedicated MSHT20 PDF sets)
 - Impact ~ 0.7 MeV

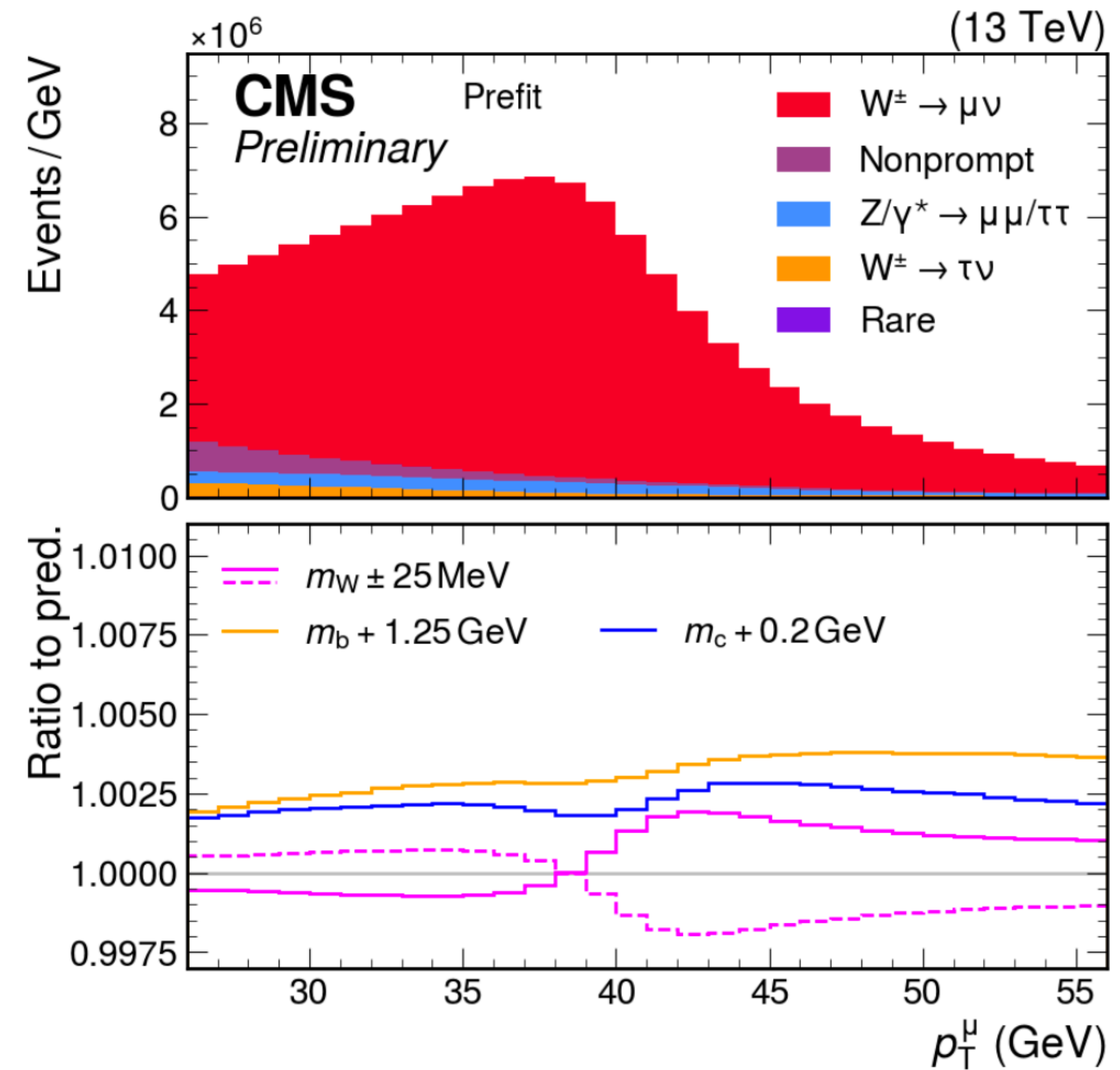
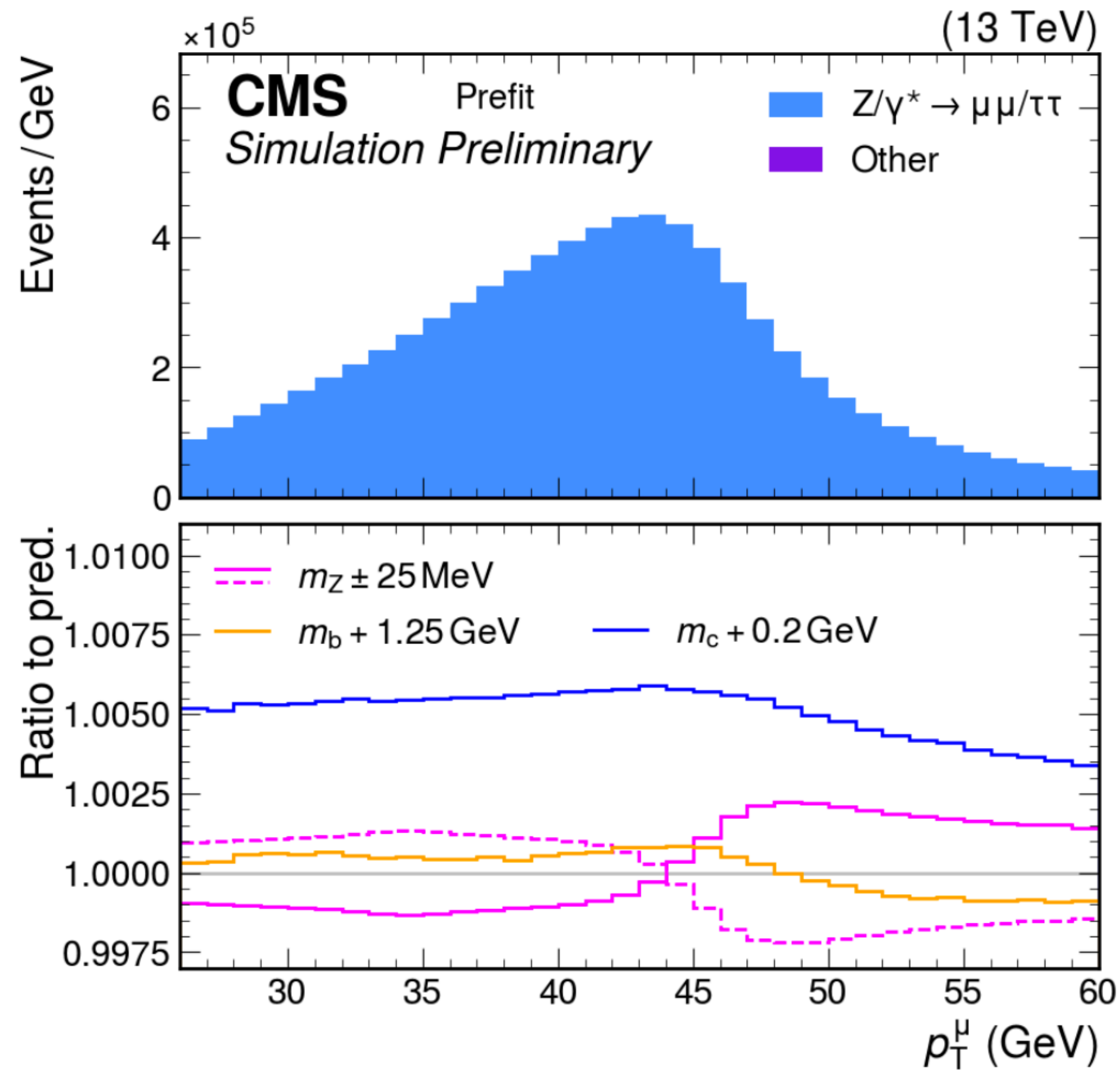

CMS W-like Z measurement

- Measurement of the Z mass in a “W-like” way: add one lepton to the p_T^{miss}
- First effort towards a W mass measurement
- Focused on calibration of muon momentum scale and recoil
- **Limited to central muons**
- In principle, a demonstration that this is possible at CMS
- Combination of technical issues (MC production) and sociological ones (loss of person power) meant the effort stopped here

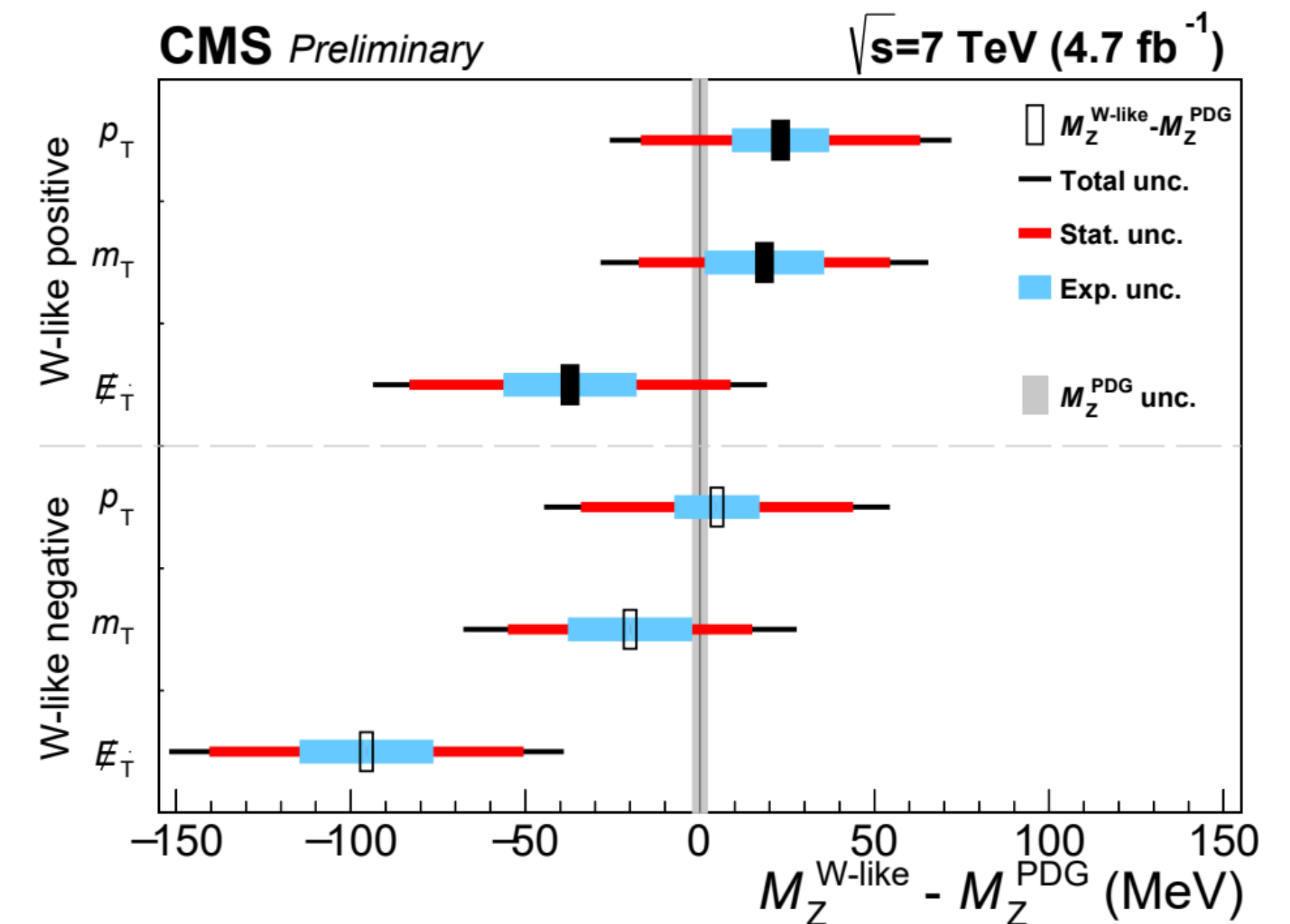
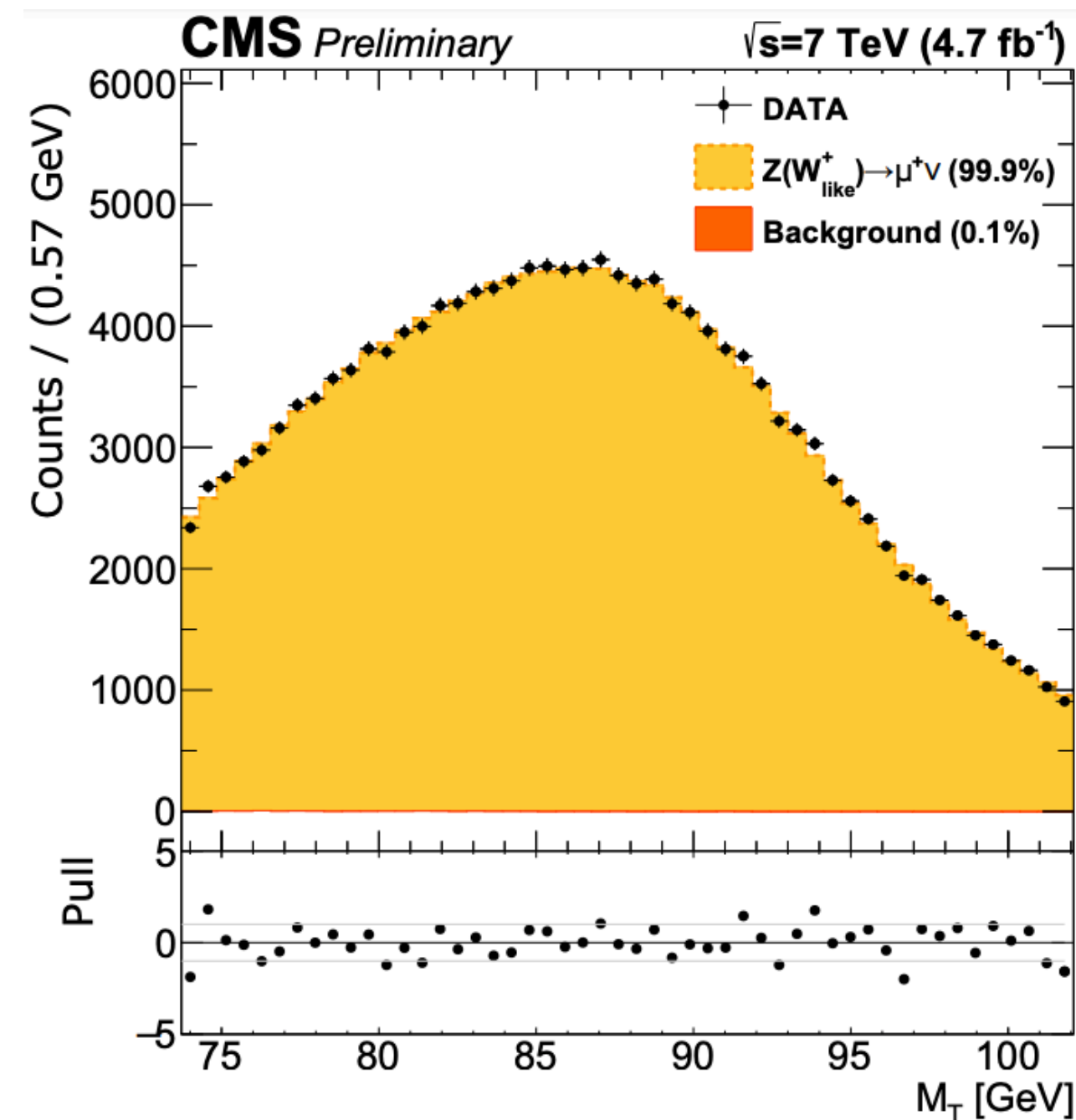
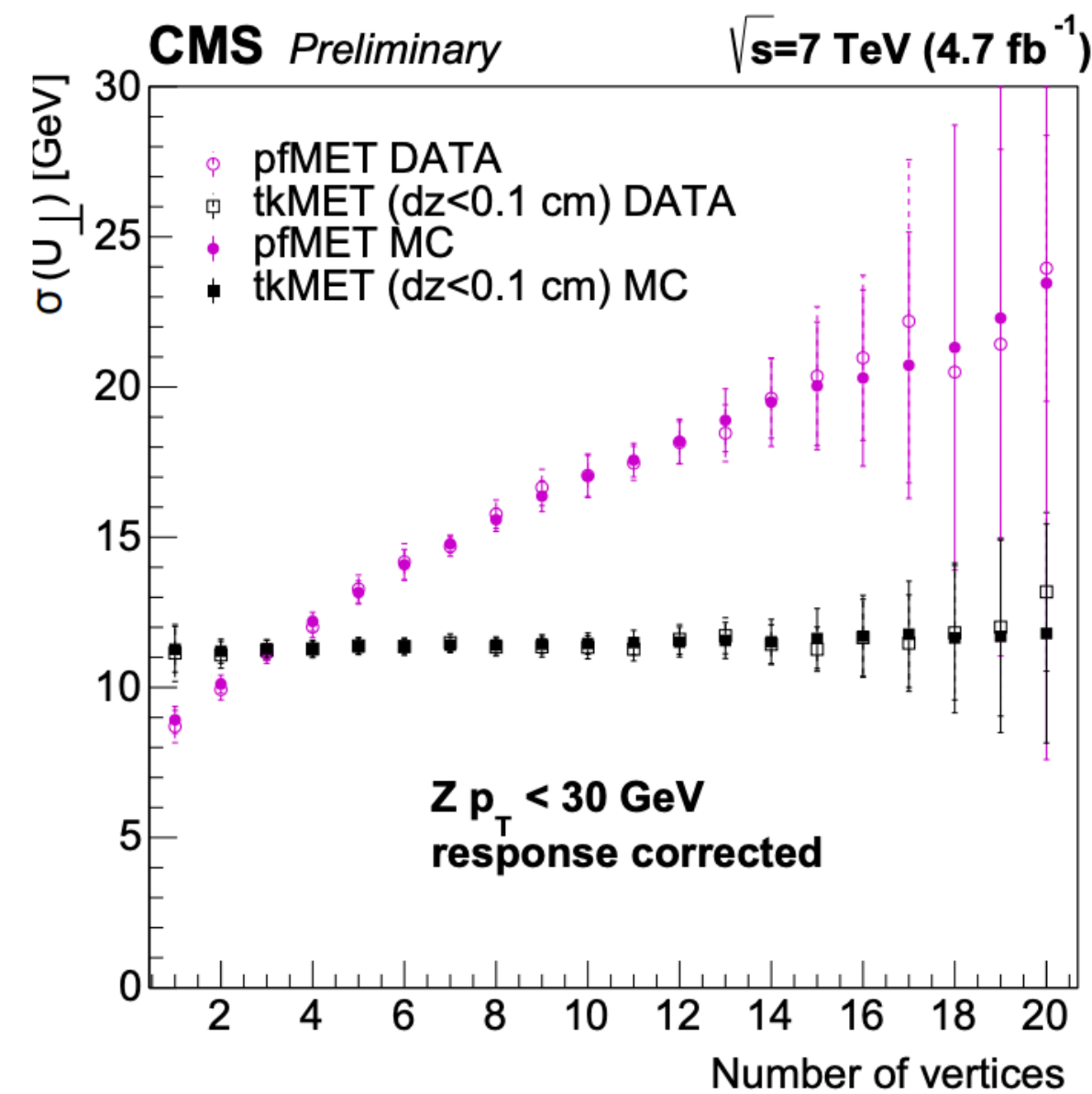

Electrons vs. Muons

- Significantly larger statistical+experimental uncertainties for electrons already in W helicity measurement
- Energy calibration is also more challenging
- Will be difficult to be competitive with muons for m_W measurements

Phys. Rev. D 102 (2020) 092012

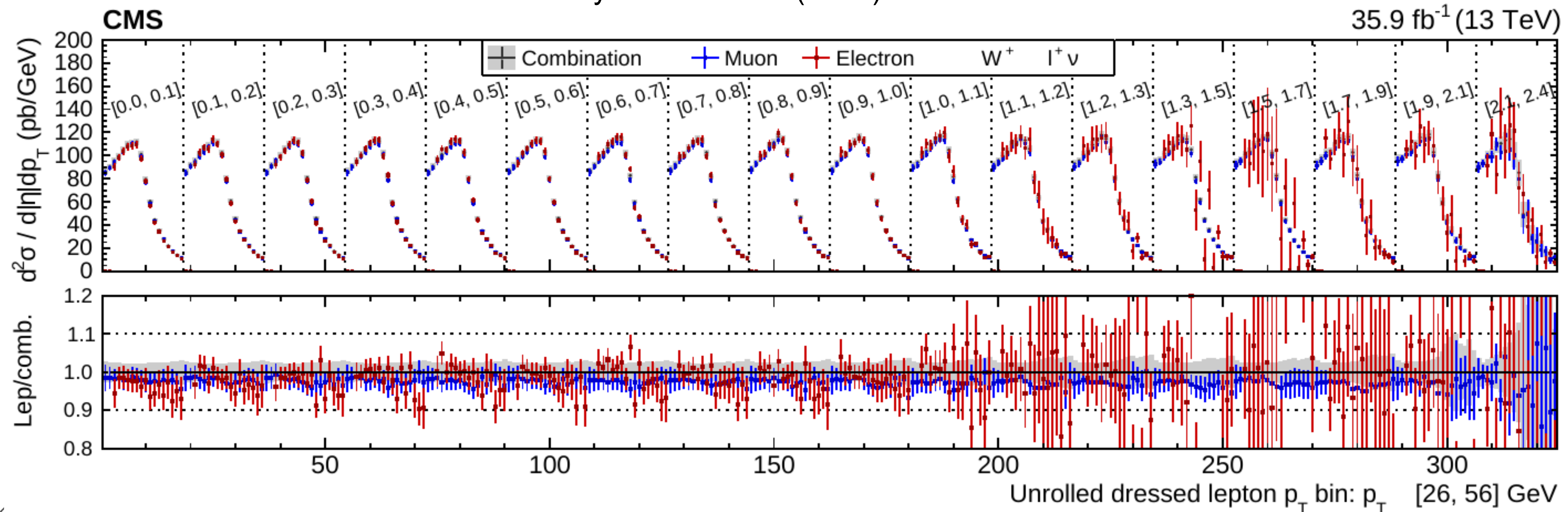

Electron energy scale calibration in CDF and ATLAS

- CDF quotes systematic uncertainties on electron energy scale $< 1e-4$
- Achieved by transporting ultra high precision tracking calibration from muons to electron tracks and then using E/p
- CDF has < 0.2 radiation lengths of material in the tracking volume
- Quoted ATLAS electron energy scale uncertainties are approaching $1e-4$, but rely maximally on $Z \rightarrow ee$ for calibration

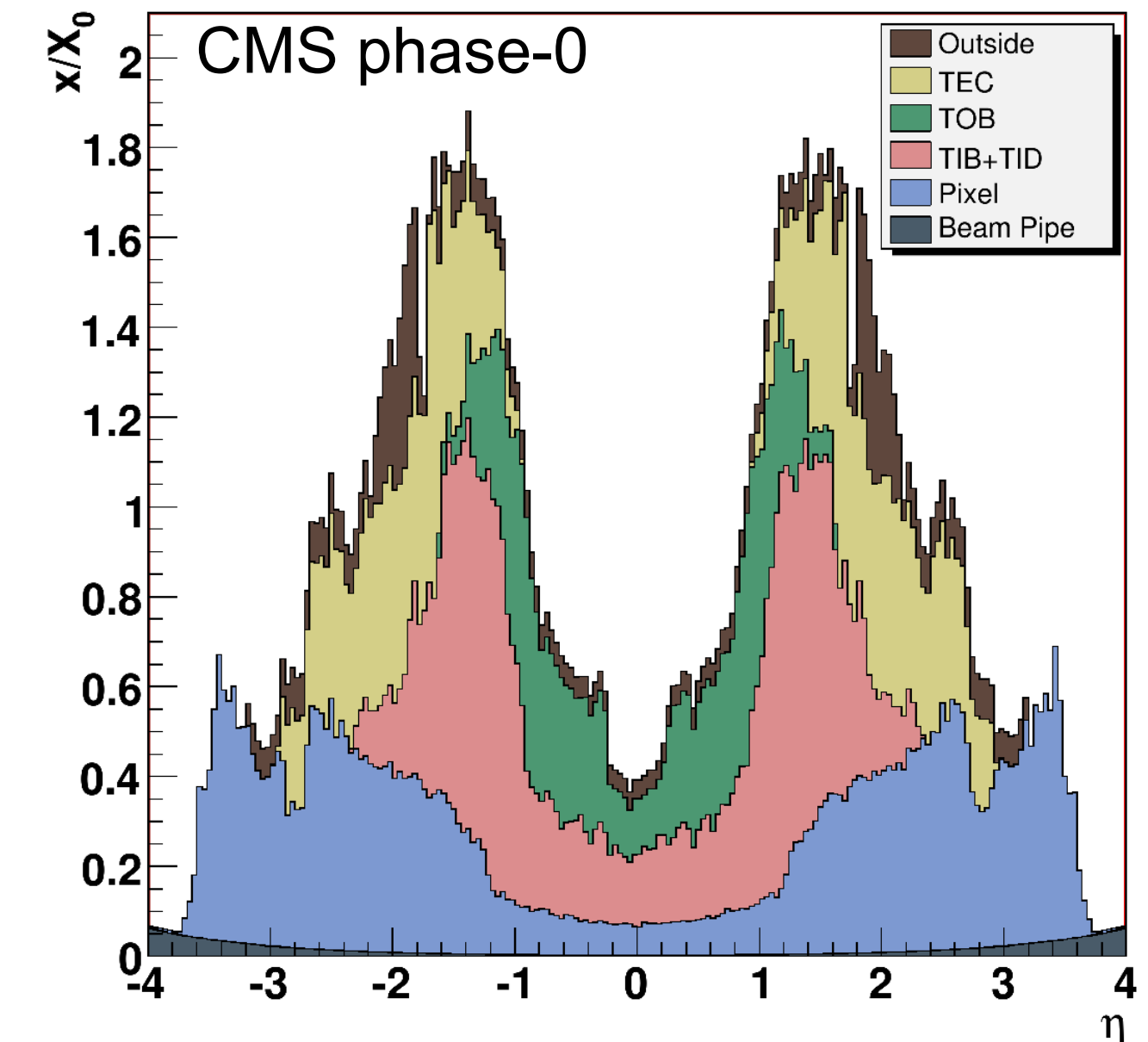
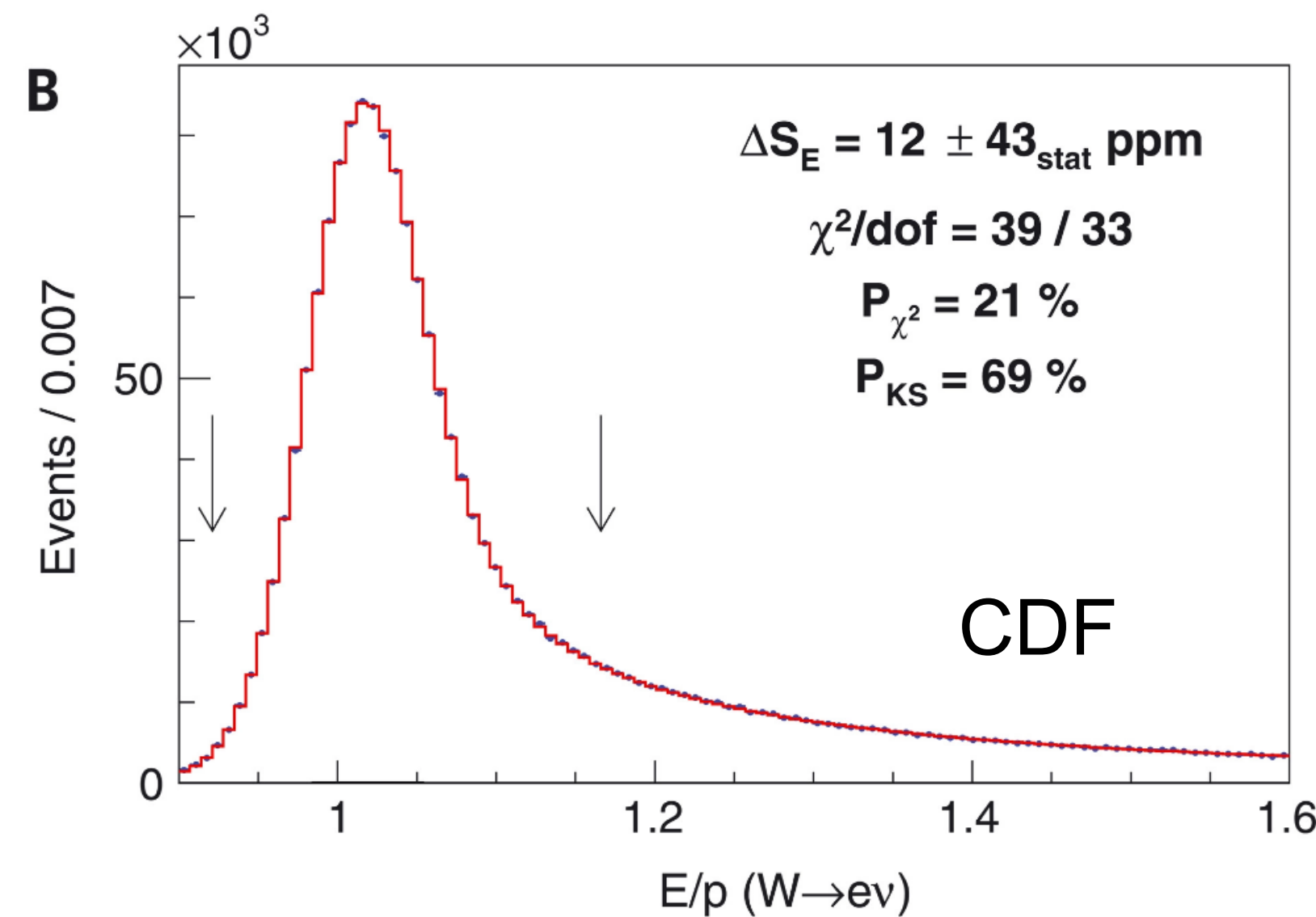
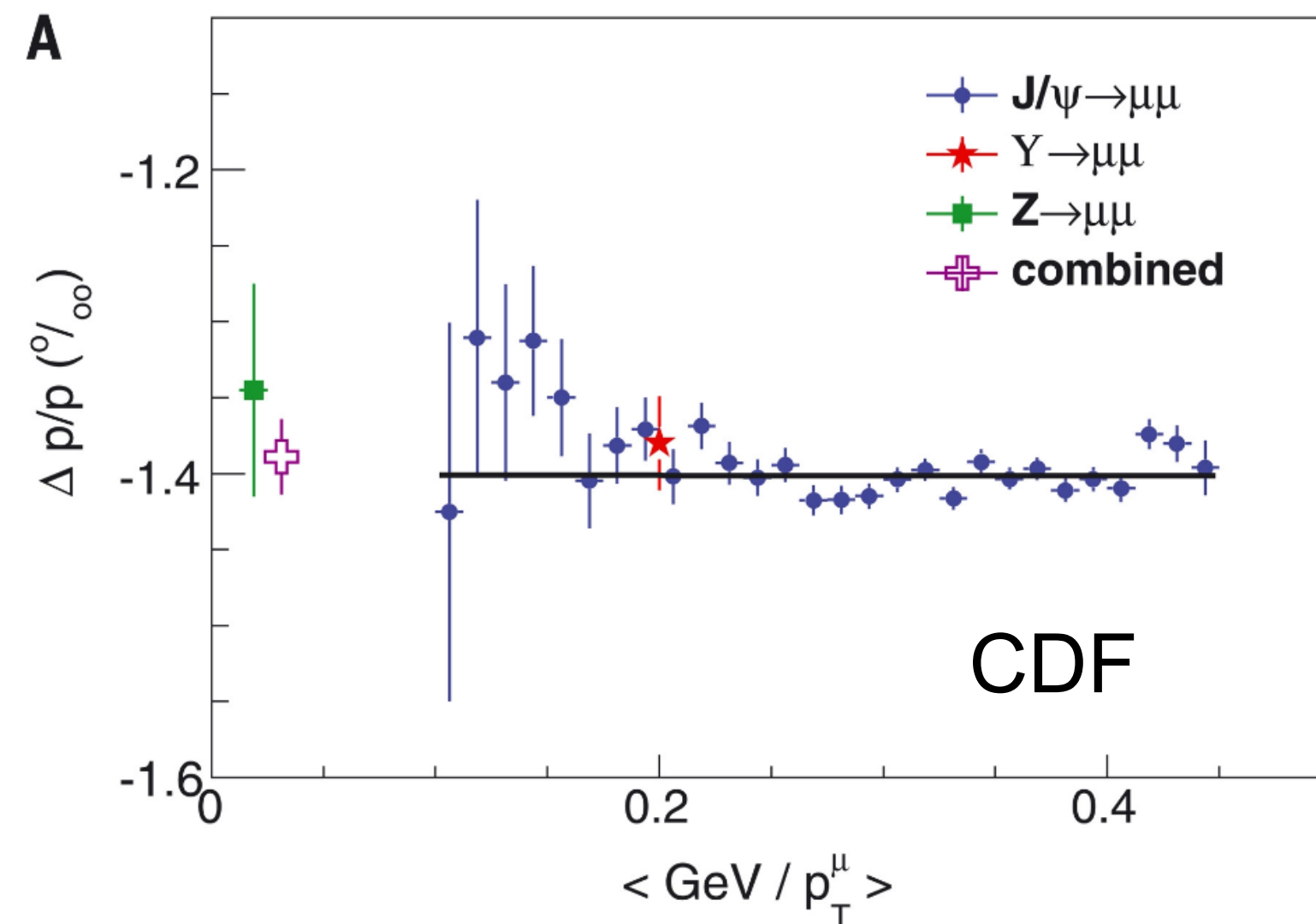
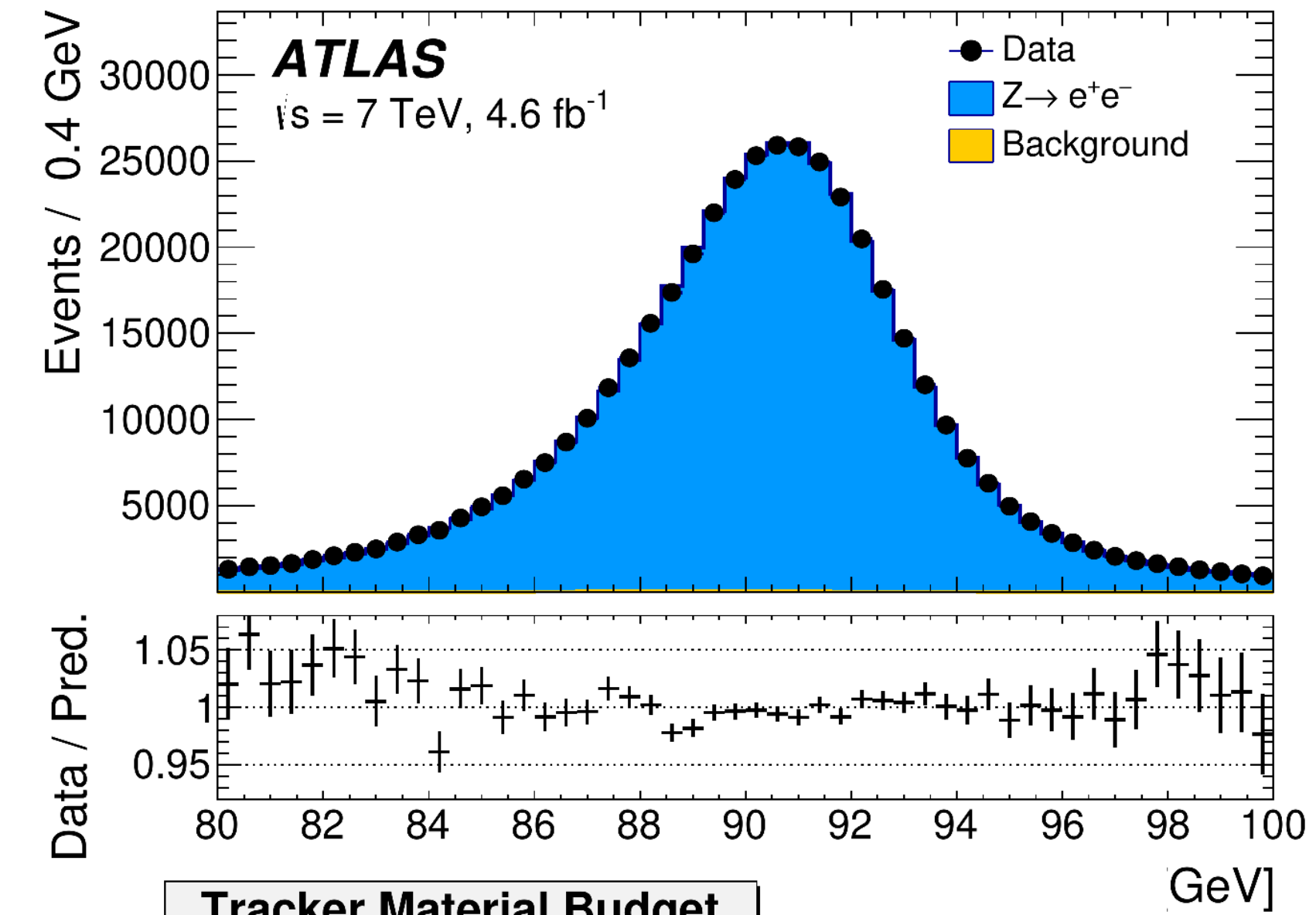

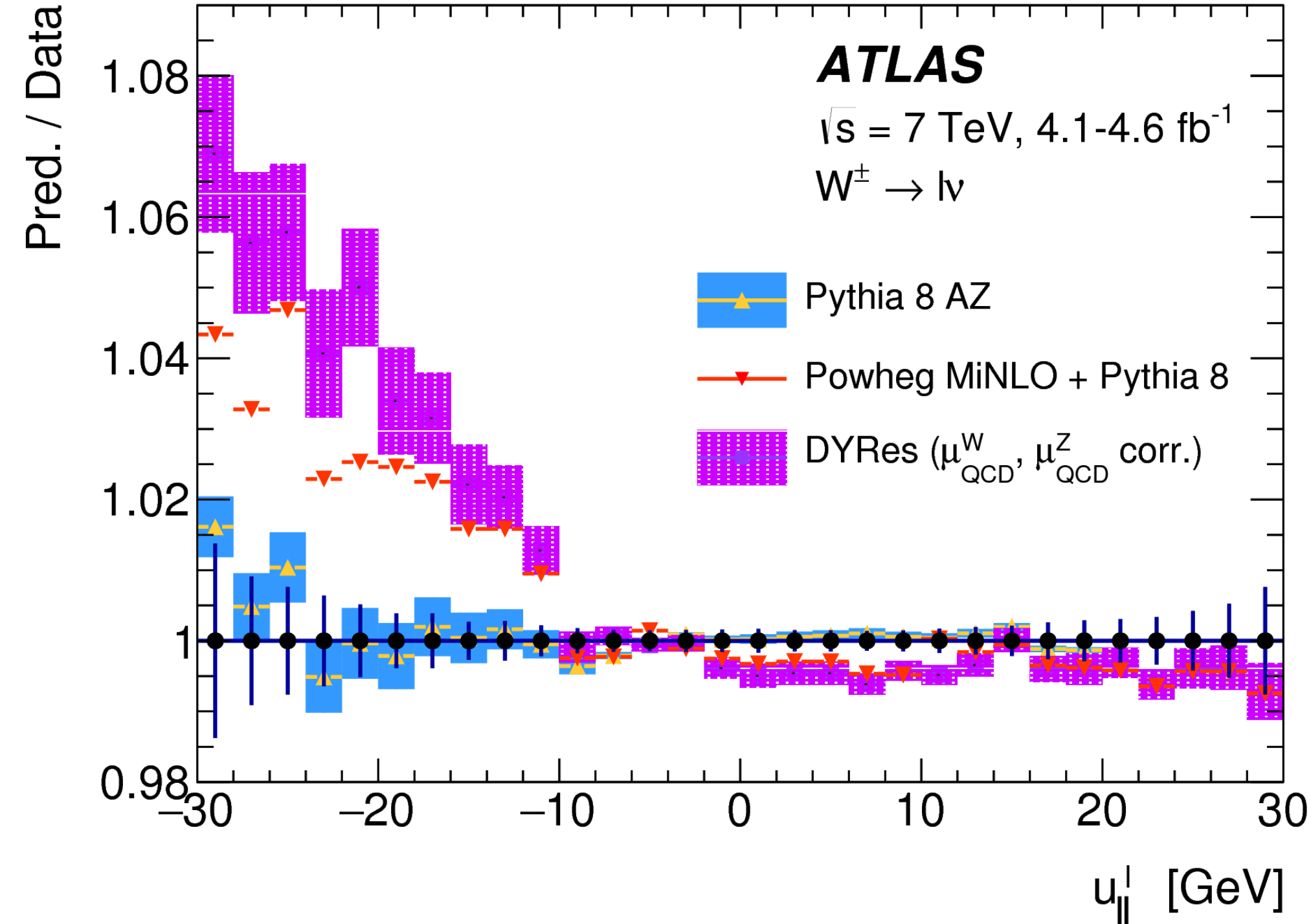
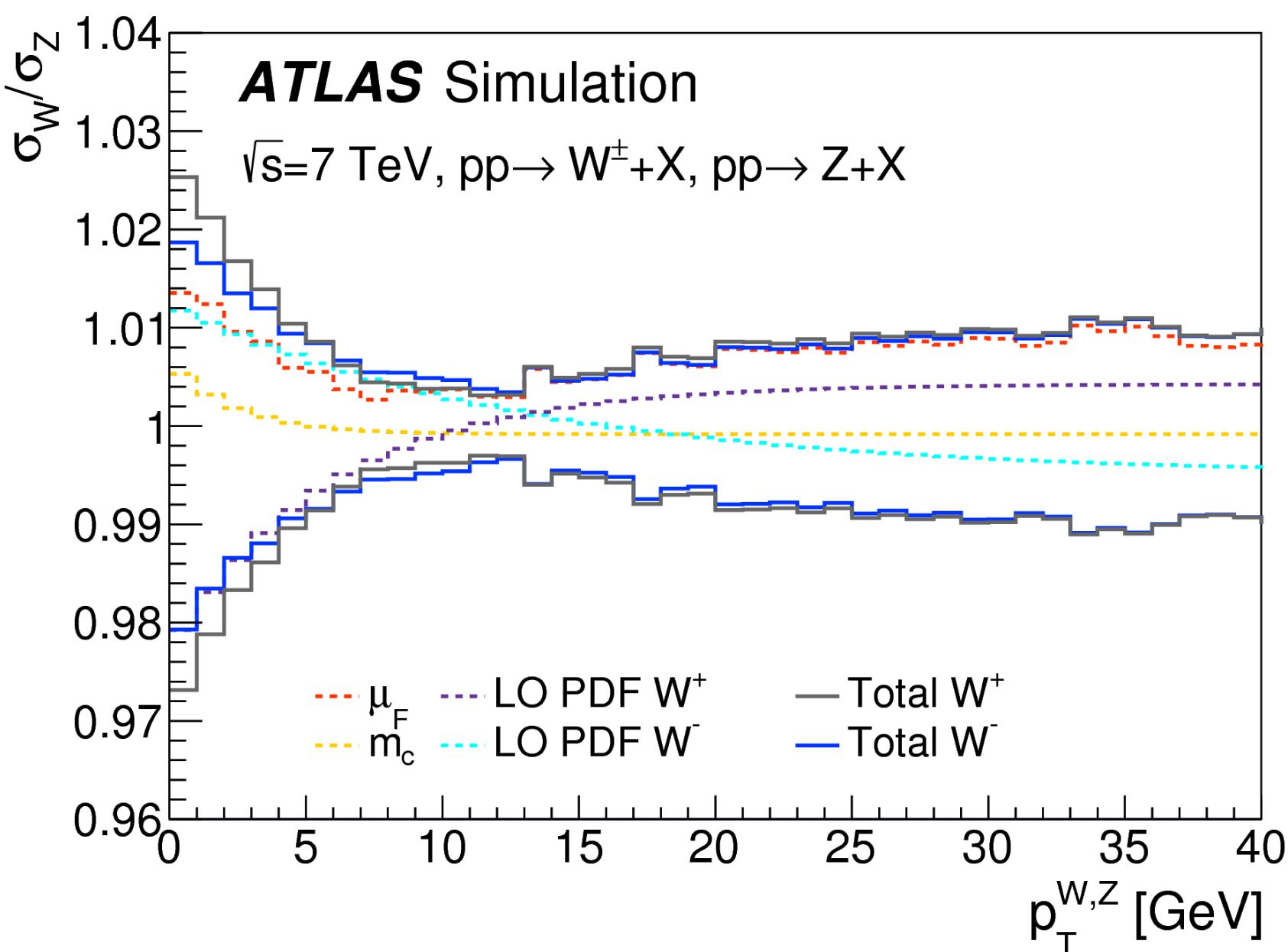
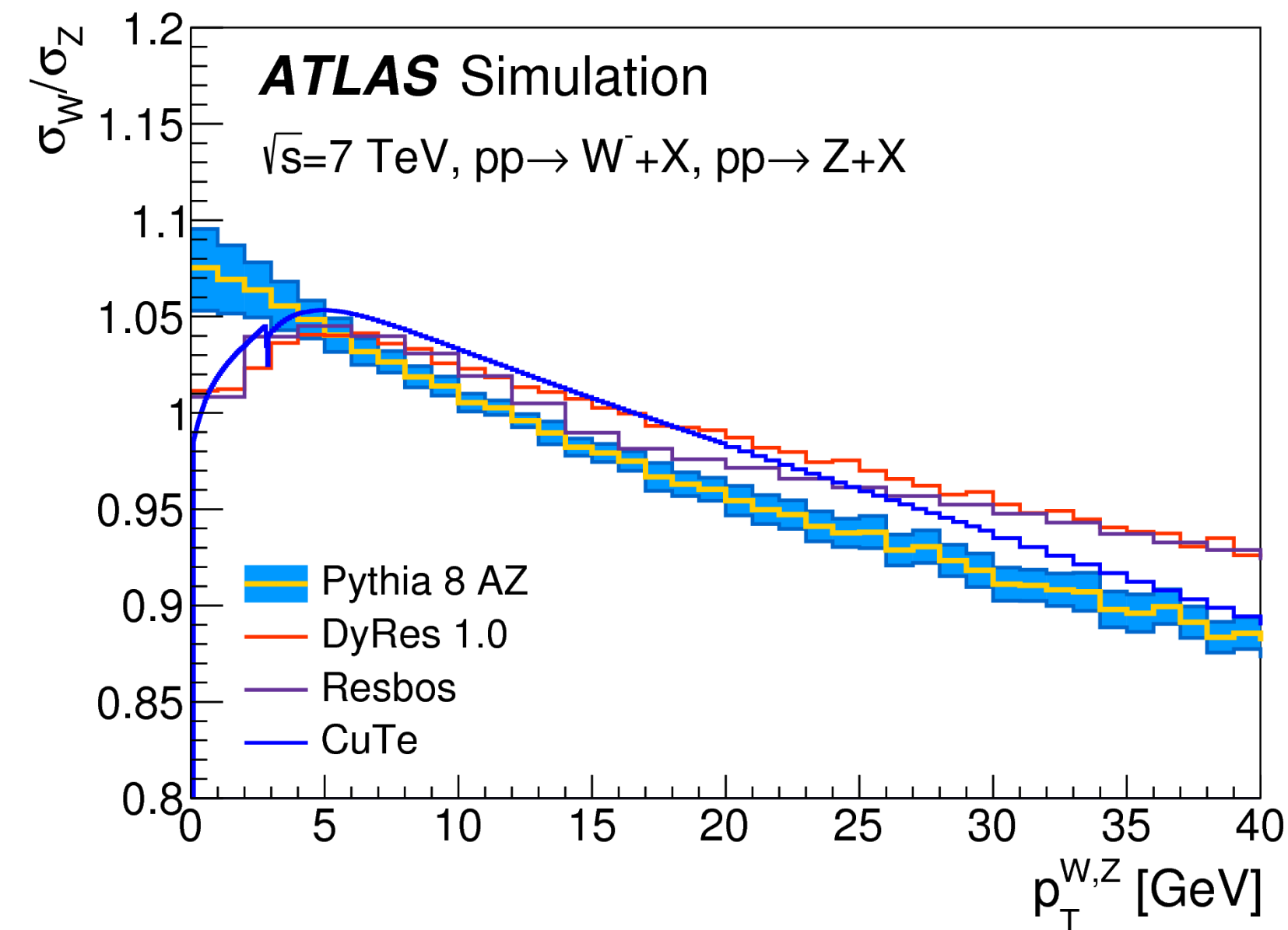

- Measured hadronic recoil distribution has some sensitivity to W p_T distribution, appears to disfavour more advanced calculations of W/Z p_T ratio
- Measurement relies on Pythia model tuned to Z p_T , with residual uncertainties for $W \rightarrow Z$ extrapolation

W -boson charge	W^+		W^-		Combined	
	p_T^ℓ	m_T	p_T^ℓ	m_T	p_T^ℓ	m_T
Kinematic distribution						
δm_W [MeV]						
Fixed-order PDF uncertainty	13.1	14.9	12.0	14.2	8.0	8.7
AZ tune	3.0	3.4	3.0	3.4	3.0	3.4
Charm-quark mass	1.2	1.5	1.2	1.5	1.2	1.5
Parton shower μ_F with heavy-flavour decorrelation	5.0	6.9	5.0	6.9	5.0	6.9
Parton shower PDF uncertainty	3.6	4.0	2.6	2.4	1.0	1.6
Angular coefficients	5.8	5.3	5.8	5.3	5.8	5.3
Total	15.9	18.1	14.8	17.2	11.6	12.9

- Detector design limits measurement to muon transverse momentum, but excellent calibration possible with quarkonia
- Unique forward phase space

$$m_W = 80354 \pm 23_{\text{stat}} \pm 10_{\text{exp}} \pm 17_{\text{theory}} \pm 9_{\text{PDF}} \text{ MeV.}$$

Source	Size [MeV]
Parton distribution functions	9
Theory (excl. PDFs) total	17
Transverse momentum model	11
Angular coefficients	10
QED FSR model	7
Additional electroweak corrections	5
Experimental total	10
Momentum scale and resolution modelling	7
Muon ID, trigger and tracking efficiency	6
Isolation efficiency	4
QCD background	2
Statistical	23
Total	32

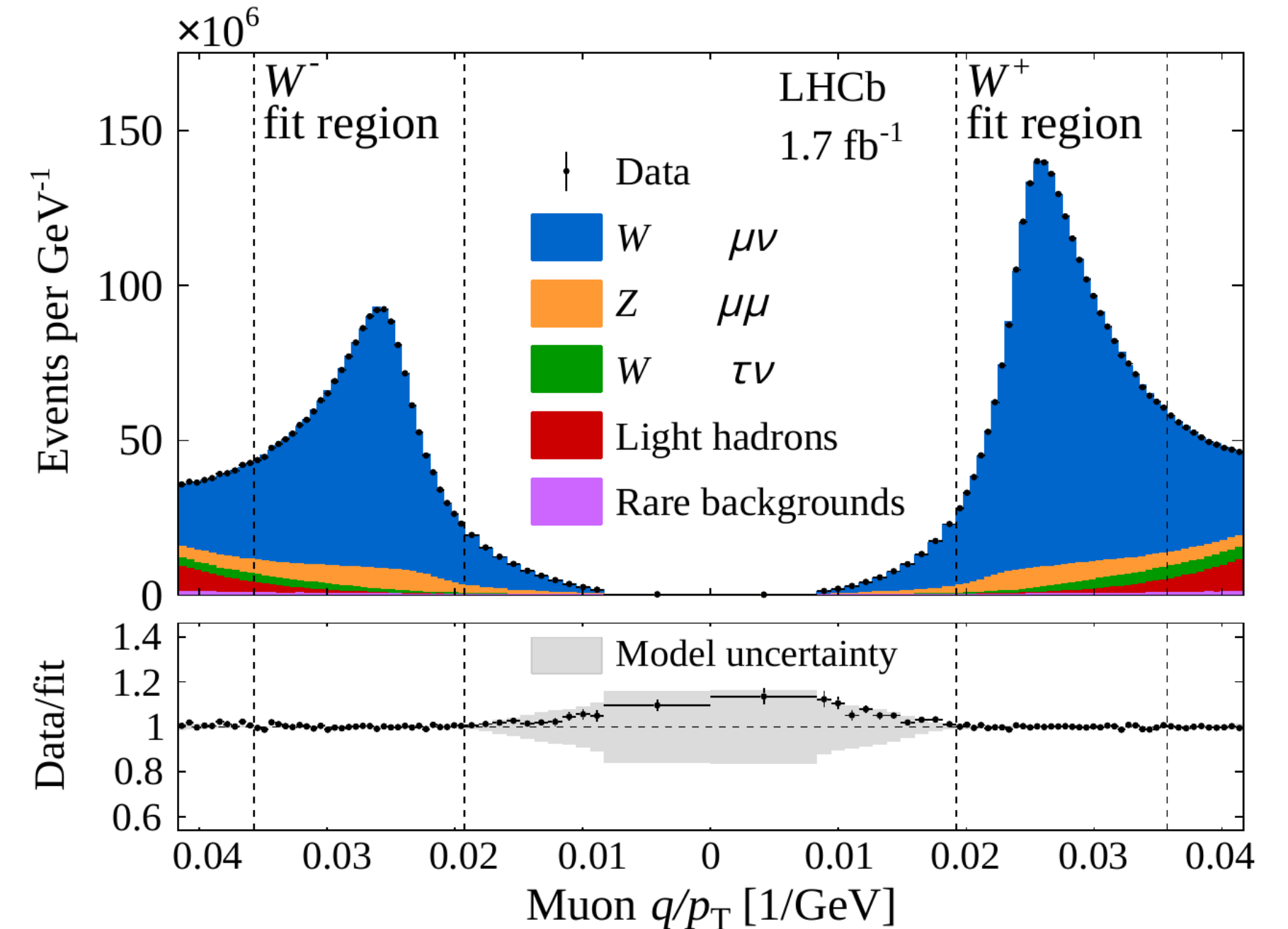
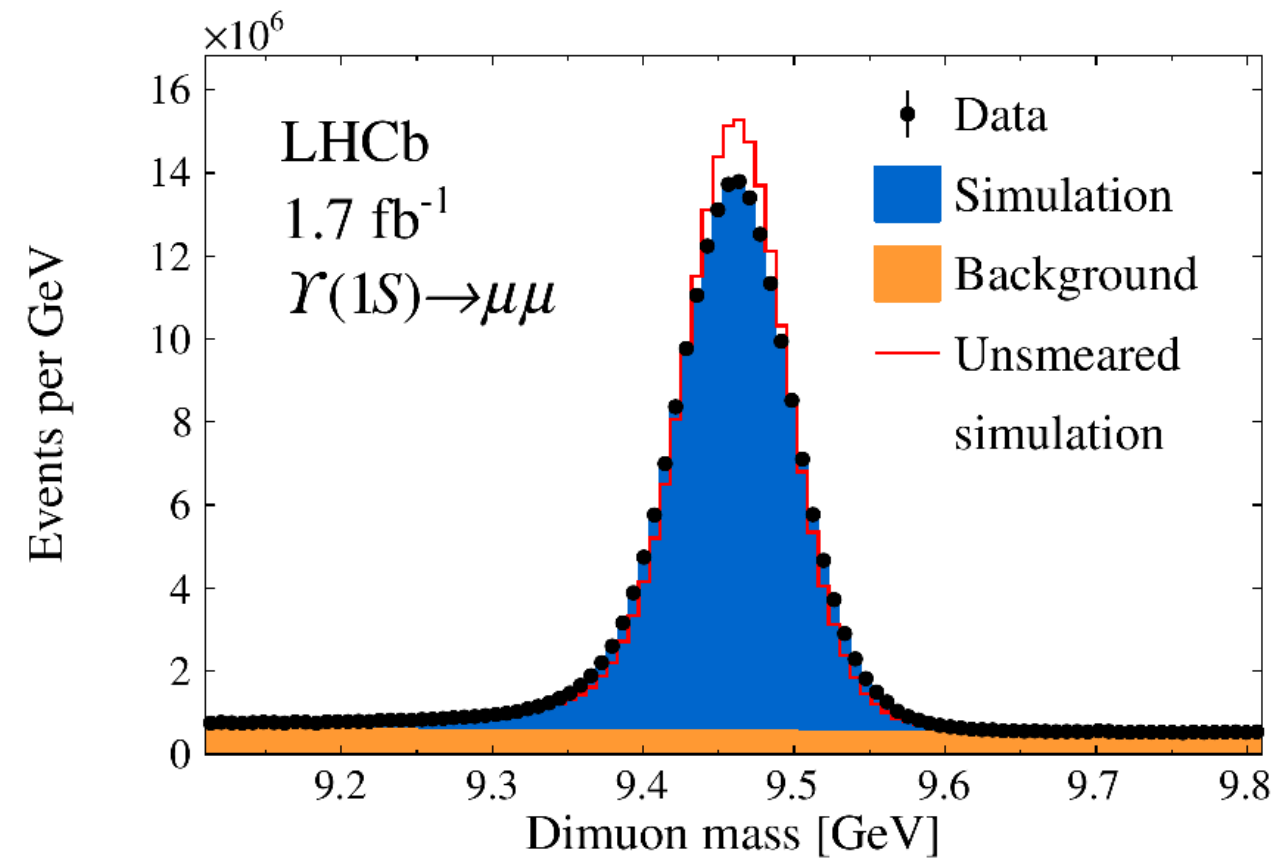
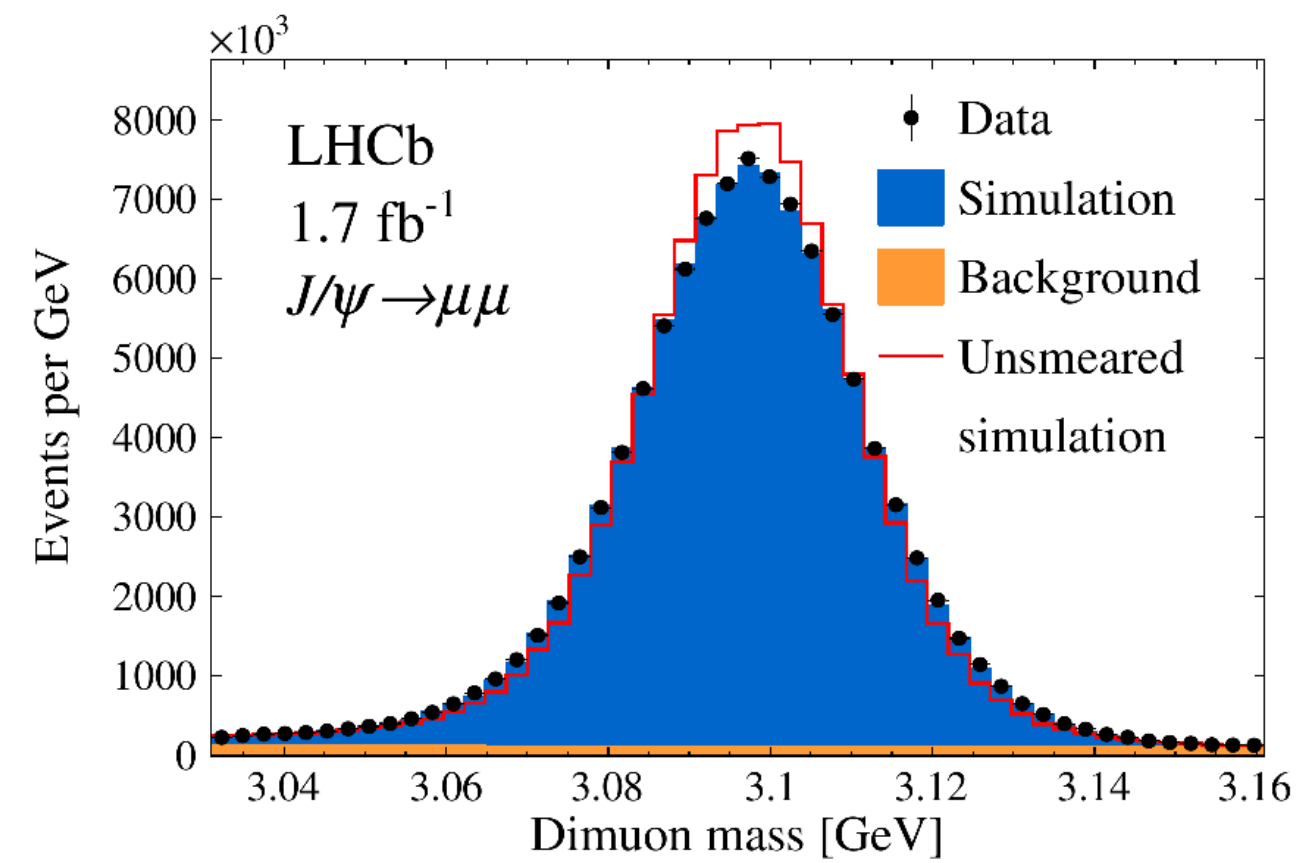

LHCb Combination prospects

- Forward phase space with respect to ATLAS and CMS leads to an anti-correlation of PDF uncertainties
- PDF uncertainties can be further reduced in combination

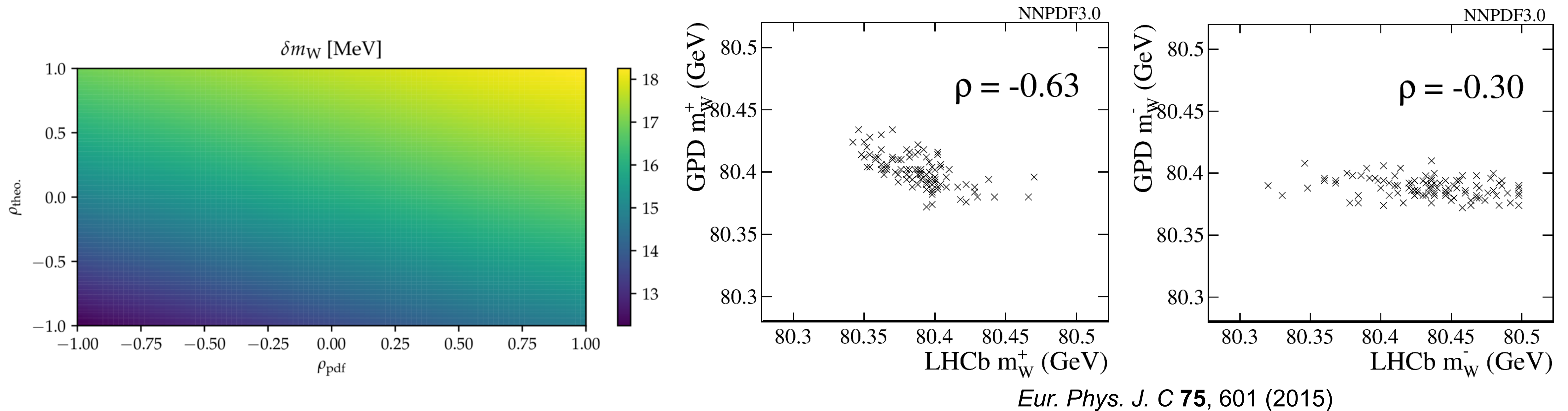

D0

- Measurement with 4.3 +1.0/fb in electron channel
- Electron energy scale, hadronic recoil, theory model calibrated/tuned with Z->ee

$$M_W = 80.375 \pm 0.023 \text{ GeV.}$$

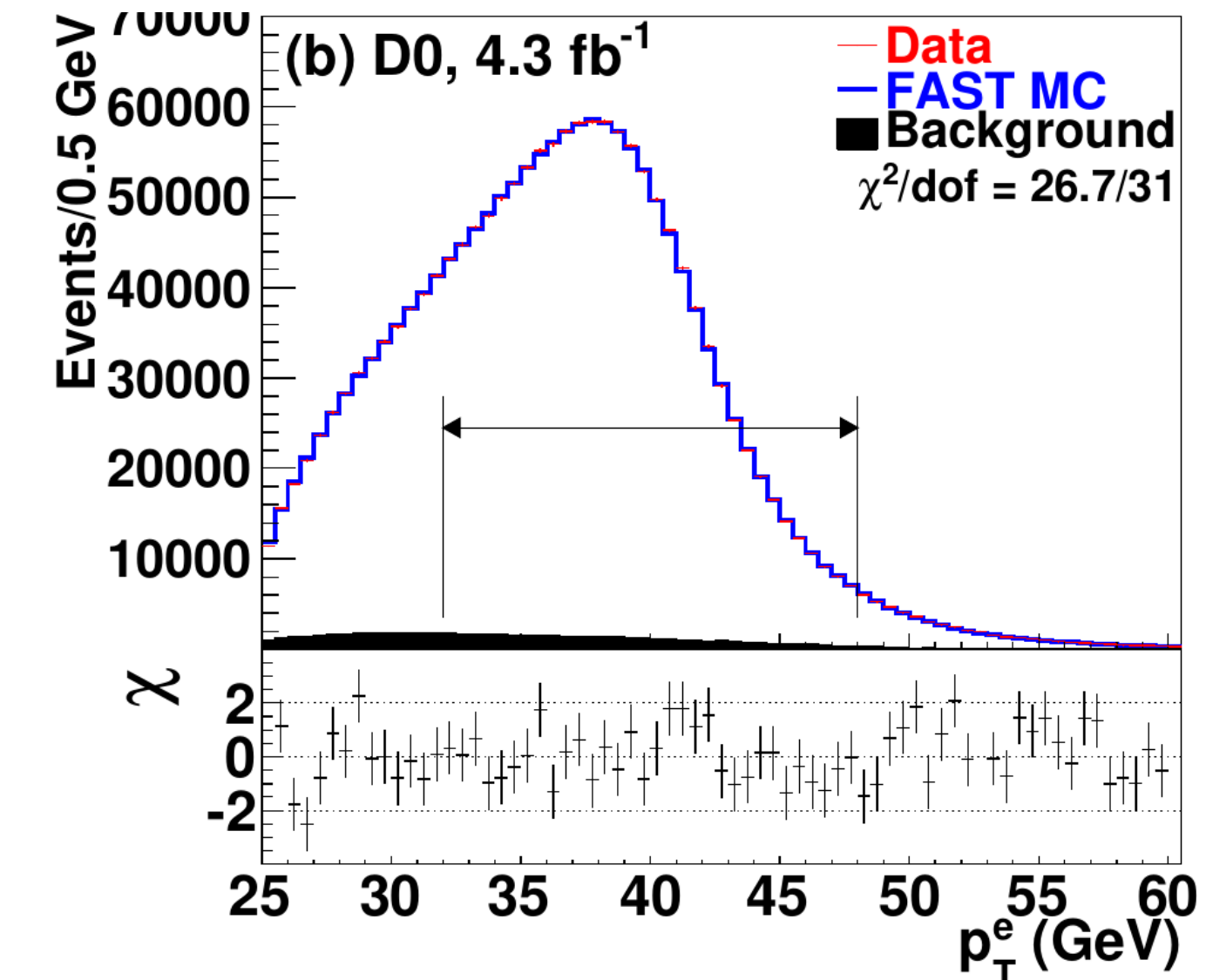
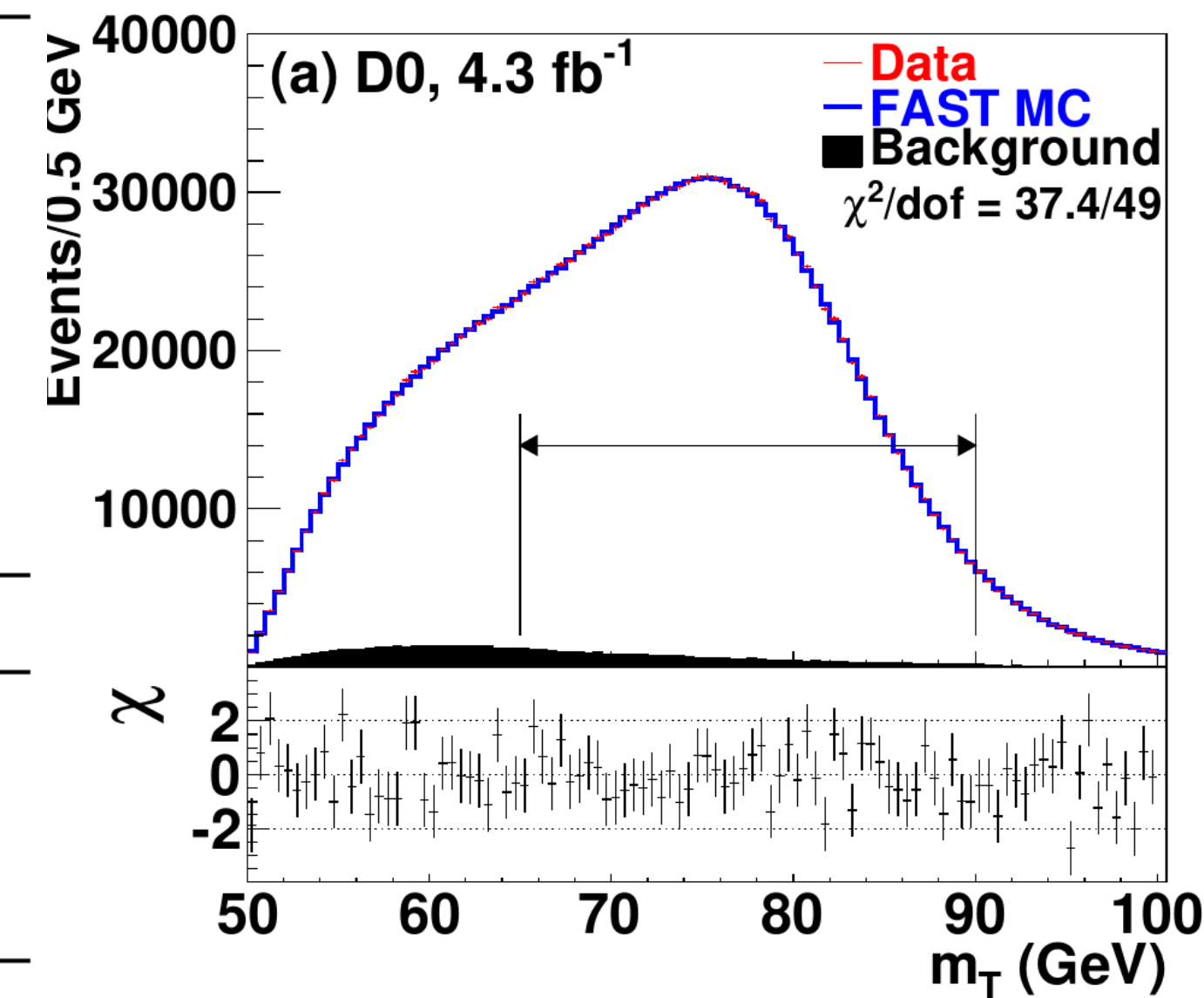
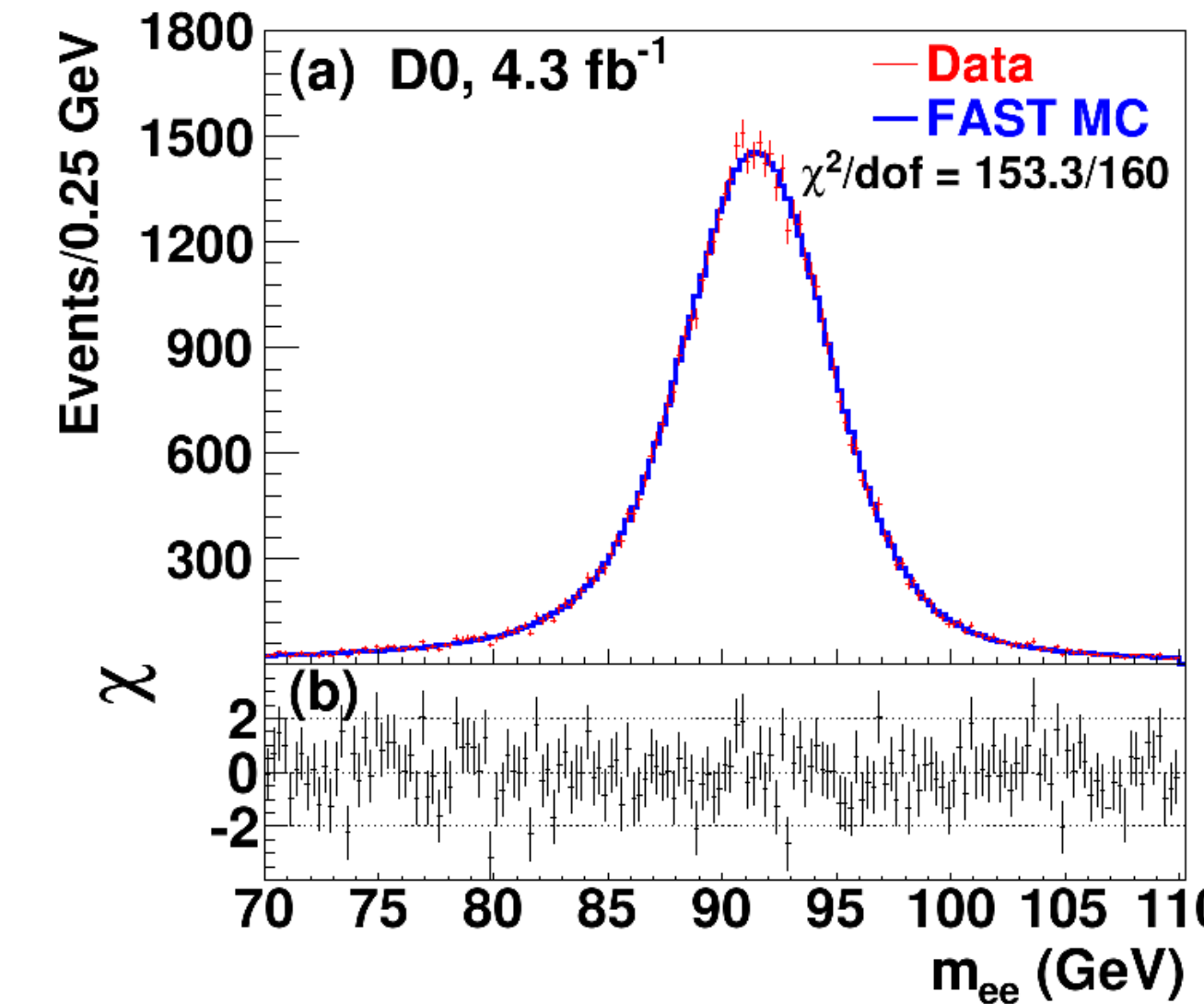
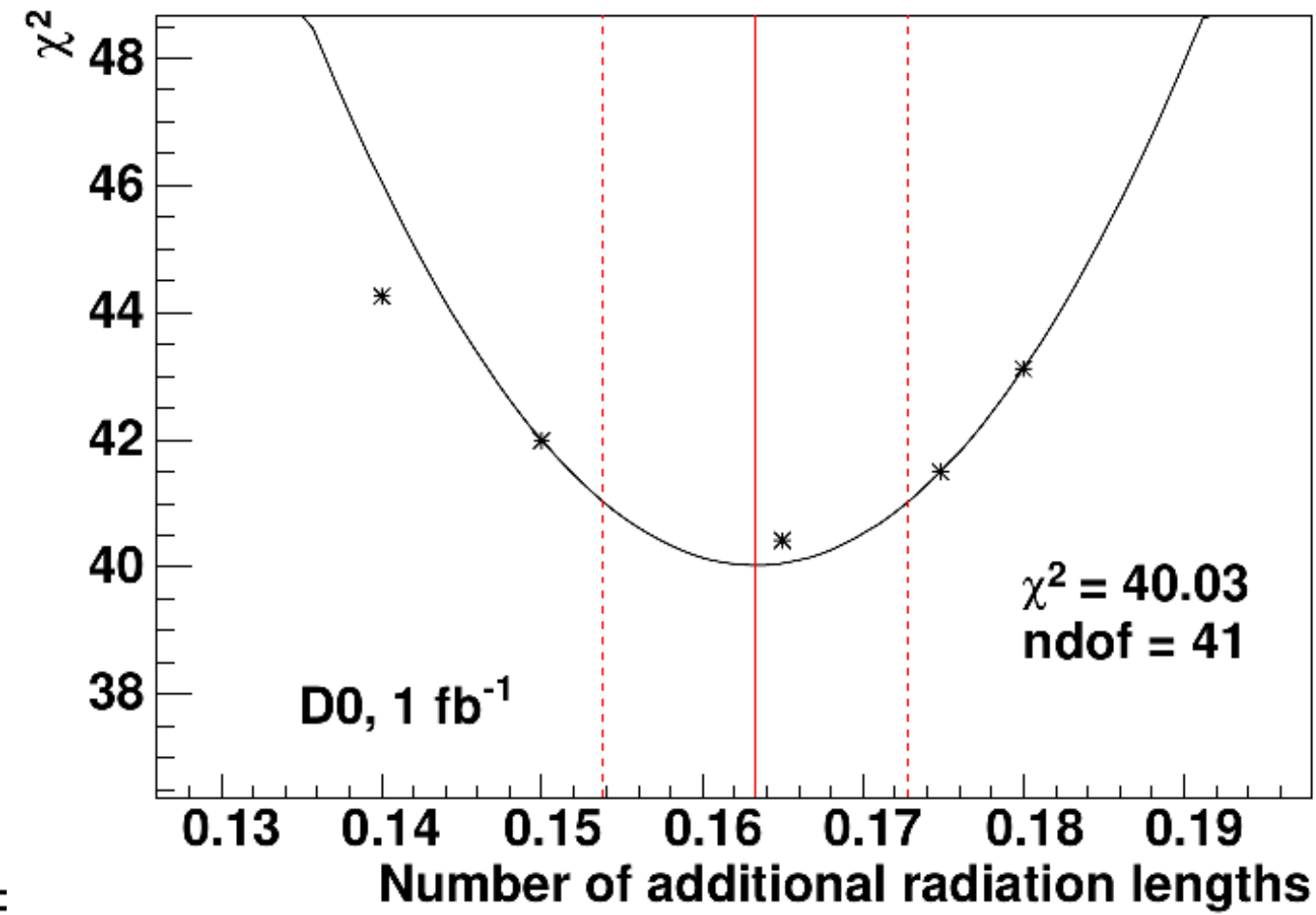

Source	m_T	p_T^e	\cancel{E}_T
Experimental			
Electron Energy Scale	16	17	16
Electron Energy Resolution	2	2	3
Electron Shower Model	4	6	7
Electron Energy Loss	4	4	4
Recoil Model	5	6	14
Electron Efficiencies	1	3	5
Backgrounds	2	2	2
$\Sigma(\text{Experimental})$	18	20	24
W Production and Decay Model			
PDF	11	11	14
QED	7	7	9
Boson p_T	2	5	2
$\Sigma(\text{Model})$	13	14	17
Systematic Uncertainty (Experimental and Model)	22	24	29
W Boson Statistics	13	14	15
Total Uncertainty	26	28	33

Variable	Fit Range (GeV)	Result (GeV)	$\chi^2/\text{d.o.f.}$
m_T	$65 < m_T < 90$	80.371 ± 0.013	37/49
p_T^e	$32 < p_T^e < 48$	80.343 ± 0.014	27/31
\cancel{E}_T	$32 < \cancel{E}_T < 48$	80.355 ± 0.015	29/31

Measurement	NNPDF3.1	NNPDF4.0	MMHT14	MSHT20	CT14	CT18	ABMP16
CDF y_Z	24 / 28	28 / 28	30 / 28	32 / 28	29 / 28	27 / 28	31 / 28
CDF A_W	11 / 13	14 / 13	12 / 13	28 / 13	12 / 13	11 / 13	21 / 13
D0 y_Z	22 / 28	23 / 28	23 / 28	24 / 28	22 / 28	22 / 28	22 / 28
D0 $W \rightarrow e\nu A_\ell$	22 / 13	23 / 13	52 / 13	42 / 13	21 / 13	19 / 13	26 / 13
D0 $W \rightarrow \mu\nu A_\ell$	12 / 10	12 / 10	11 / 10	11 / 10	11 / 10	12 / 10	11 / 10
ATLAS peak CC y_Z	13 / 12	13 / 12	58 / 12	17 / 12	12 / 12	11 / 12	18 / 12
ATLAS $W^- y_\ell$	12 / 11	12 / 11	33 / 11	16 / 11	13 / 11	10 / 11	14 / 11
ATLAS $W^+ y_\ell$	9 / 11	9 / 11	15 / 11	12 / 11	9 / 11	9 / 11	10 / 11
Correlated χ^2	75	62	210	88	81	41	83
Total χ^2 / d.o.f.	200 / 126	196 / 126	444 / 126	270 / 126	210 / 126	162 / 126	236 / 126
$p(\chi^2, n)$	0.003%	0.007%	$< 10^{-10}$	$< 10^{-10}$	0.0004%	1.5%	10^{-8}

Table 6: χ^2 per degree of freedom for the Tevatron Z -rapidity and W^- and l -asymmetry measurements at $\sqrt{s} = 1.96$ TeV, and the LHC Z -rapidity and W lepton-rapidity measurements at $\sqrt{s} = 7$ TeV. The total χ^2 is the sum of those quoted for individual measurements along with a separate contribution for correlated uncertainties, where the latter is extracted using a nuisance parameter representation of the χ^2 [47]. The CT14 and CT18 PDF uncertainties correspond to 68% coverage, obtained by rescaling the eigenvectors by a factor of 1/1.645. The probability of obtaining a total χ^2 at least as high as that observed is labelled $p(\chi^2, n)$.