



CMB-S4: overview and proposed IN2P3 involvement

R. Stompor (CPB), Damien Prêle (APC)

on behalf of the CMB-S4@IN2P3 team

Horacio Arnaldi⁽¹⁾, James Bartlett⁽¹⁾, Olivier Bourrion⁽⁴⁾, Andrea Catalano⁽⁴⁾, Céline Combet⁽⁴⁾, Jacques Delabrouille⁽²⁾, Elena de la Hoz⁽²⁾, Cyrille Doux⁽⁴⁾, Josquin Errard⁽¹⁾, Ken Ganga⁽¹⁾, Xavier Garrido⁽³⁾, Manuel Gonzalez⁽¹⁾, Jean-Christophe Hamilton⁽¹⁾, Sophie Henrot-Versillé⁽³⁾, Julius Hrivnac⁽³⁾, Marine Kuna⁽⁴⁾, Fabian Lambert⁽⁴⁾, Sotiris Loucatos⁽¹⁾, Thibaut Louis⁽³⁾, Juan Macias Pérez⁽⁴⁾, Frédéric Mayet⁽⁴⁾, Jérôme Odier⁽⁴⁾, Julien Peloton⁽⁴⁾, Laurence Perotto⁽⁴⁾, Michel Piat⁽¹⁾, Damien Prêle⁽¹⁾, Fatah Rarbi⁽⁴⁾, Radek Stompor⁽²⁾, Jean-Pierre Thermeau⁽¹⁾, Steve Torchinsky⁽¹⁾, Matthieu Tristram⁽³⁾, Christophe Vescovi⁽⁴⁾

- (1) AstroParticule et Cosmologie (APC)
- (2) Centre Pierre Binétruy (CPB)
- (3) Laboratoire de Physique de 2 infinis, Irène Joliot-Curie, (IJCLab)
- (4) Laboratoire de Physique Subatomique et Cosmologie, (LPSC)



Overview



- An “ultimate”, ground-based CMB polarization experiment aiming at key science goals:
 - primordial gravitational waves, number of relativistic species of particles, neutrino mass scales (hierarchy), ...
- Provide a significant leap in the precision/reach and set the reference for the next few decades and prepare the ground for post-2050 and complement whatever happens in space for ~2030 ...
- Multi-telescope, multi-site, multi-survey, long operation length, community-wide ...
 - ~500, 000 detectors, decade-long observations, huge redundancy, validated technologies.
 - ~\$500 - \$700 M, decade+ of development/preparations.

History



- Started in 2013 as a white paper for the Snowmass process resulting in the endorsement from the Particle Physics Project Prioritization Panel (P5) in 2014 and National Academy reports in 2015.
- A scientific collaboration established in 2015.
- Science and Technology books made public in 2016 and 2017, respectively.
- In 2017 Concept Definition Task Force set up by DOE and NSF.
- “Science Case, Reference Document, and Project Plans” published in 2019.
- Since 2019 accepted as DOE project (Critical Decision 0) and NSF project (Project development funds) – a target deployment date 2028.
 - In 2020 LBNL appointed the DOE-lead and Chicago the NSF-lead.
- In late 2021/early 2022, overhaul of the design following the NSF OPP inputs – Analysis of Alternatives.
- In late 2022 new, post-AoA, concept accepted by DOE and NSF: a new baseline design and a revised schedule (deployment in 2031).

Science Drivers



sufficient on-the-sky sensitivity to

- either set a limit on the amplitude of the primordial gravitational waves of $r < 0.001$ (95σ)
- or detect $r > 0.003$ with more than 5σ significance;

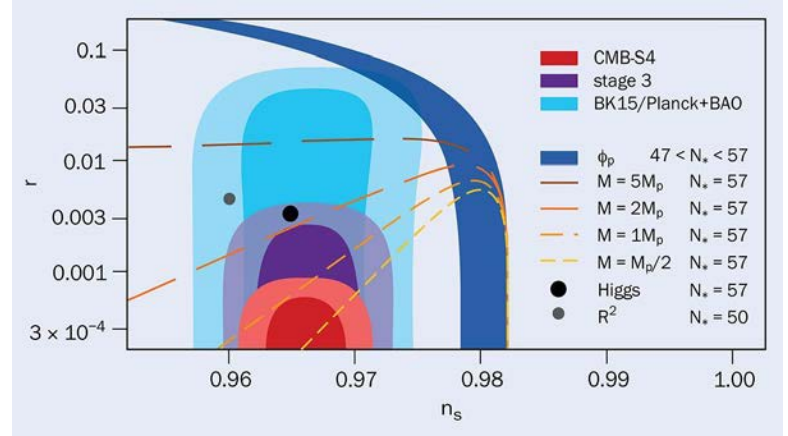
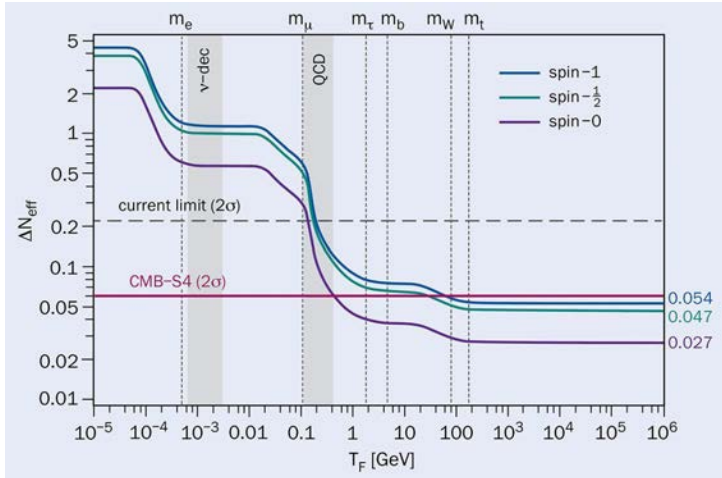

constraining the effective number of relativistic species of light particles (N_{eff}) in the early Universe down to $\Delta N_{\text{eff}} < 0.06$ (95σ).

Science Impact

- Four major scientific themes:

1. primordial gravitational waves and inflation;

2. the dark Universe;

- neutrino mass scale
- dark matter.

3. mapping matter in the cosmos;

- lensing
- clusters

4. the time-variable millimeter-wave sky.

- multi-messenger campaigns

+ legacy maps

+ joint analyses with other surveys.

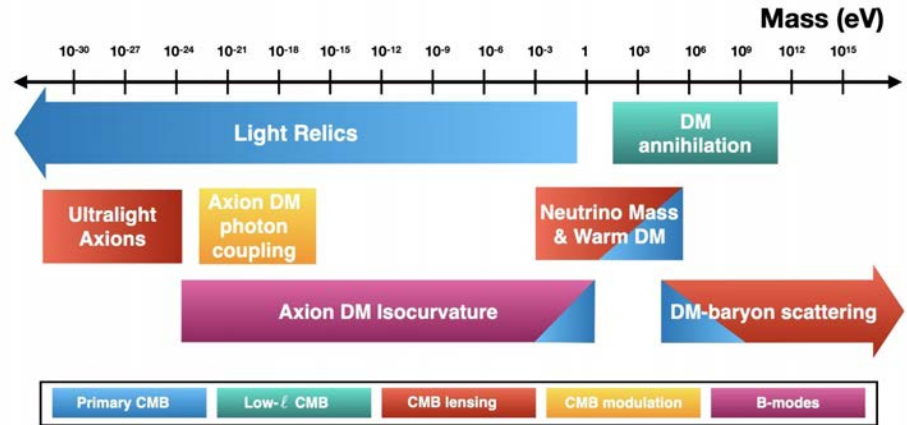

arXiv: 1907.04473

CMB-S4 experiment (post-AoA)



South Pole:

1-3% of the sky

1 Large (5m) Aperture Telescope
20, 25, 40, 90, 150, 220, 280 GHz

3 (3 tubes each) Small Aperture Telescopes
20, 40, 85, 145, 90, 150, 220, 280 GHz

Operations: up to 10 years

Atacama:

40-60% of the sky

2 Large Aperture (6m) Telescopes
25, 40, 90, 150, 220, 280 GHz

Operations: 7 years



South Pole Site (NSF/OPP)

1 Large Aperture
(5 m) Telescope

3 Small Aperture Telescopes
(9 0.5-m aperture optics tubes)



Chile (Atacama) Site

2 Large Aperture (6 m)
Telescopes

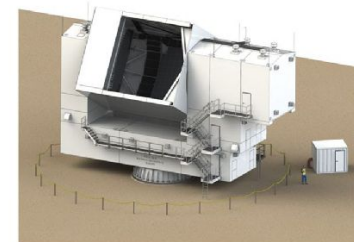
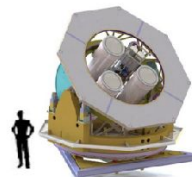
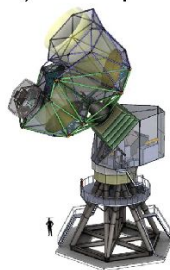

CMB-S4

CMB-S4 experiment: organization



Collaboration:



- Best-of-effort involvement
- 459 scientists
- 122 institutes
- 16 Countries; 5 (+1) continents

preparations of and scientific exploitation of the data sets

Project:



- Led by Integrated Project Office
- ~70 scientists/engineers
- Mostly US-based, so far international contributions on individual basis (informal)
- Global workflow + international participation
 - Data rights etc
 - Buy-ins + in-kind contributions

instrument development/construction, operations, data management, low-level data analysis (up to single frequency maps of the sky)

Cost: ~\$770 M (DOE+NSF+international partners)

CMB-S4: scientific collaboration



- Low-ell B-mode AWG
- Systematic AWG
- Clusters and Point Sources AWG
- LiteBIRD-CMB S4 Task Force

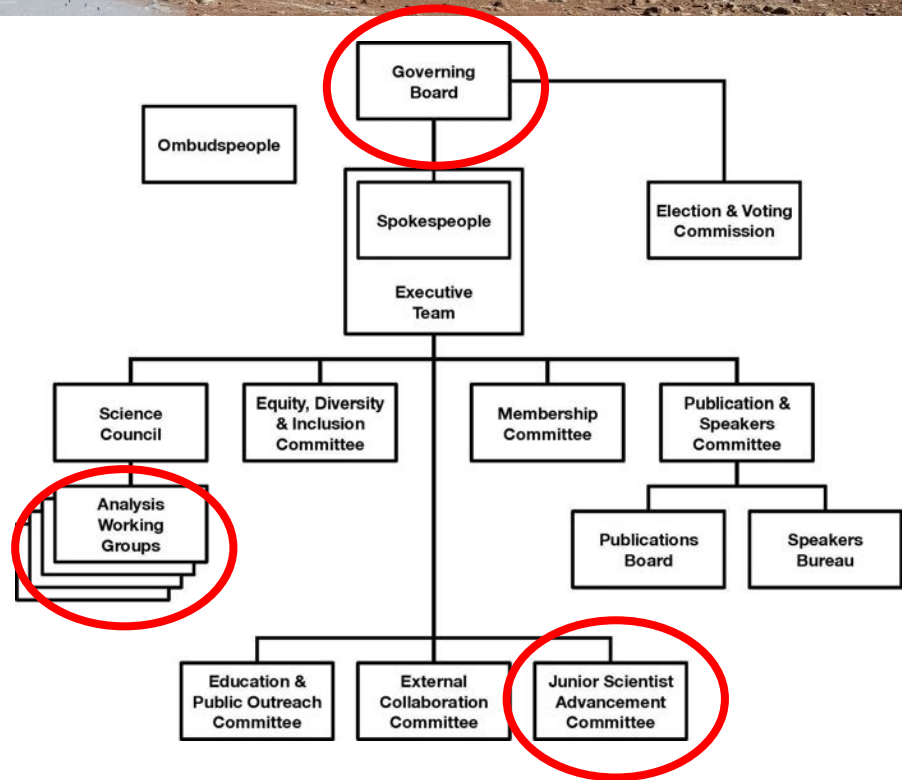

CMB-S4: DOE/NSF project

CMB-S4 Integrated Project Office

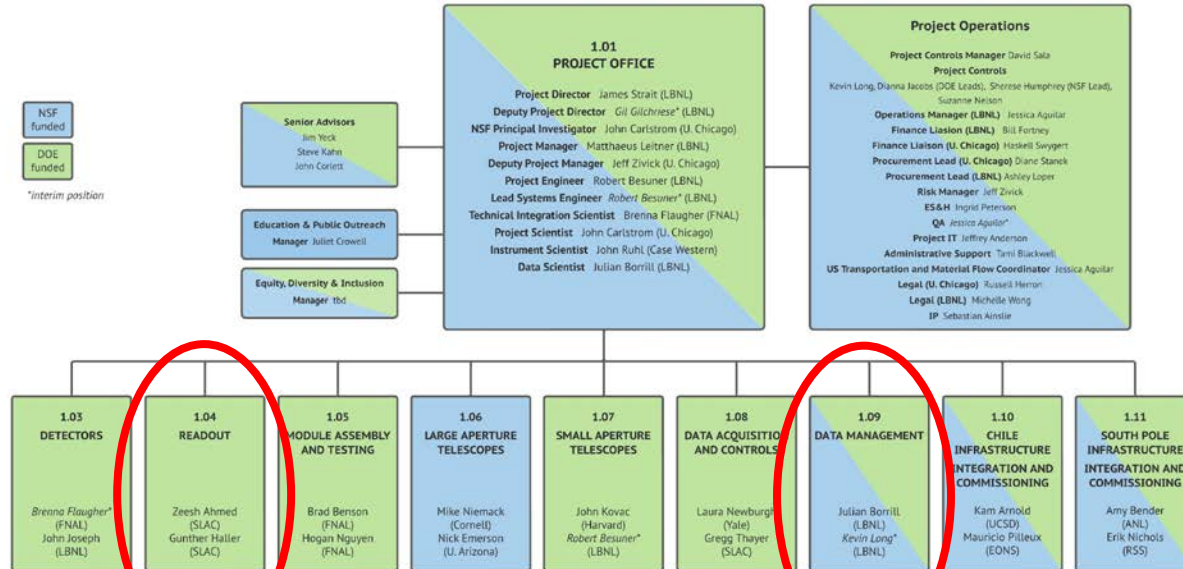

Date:

Approved:

Global project timeline (1)

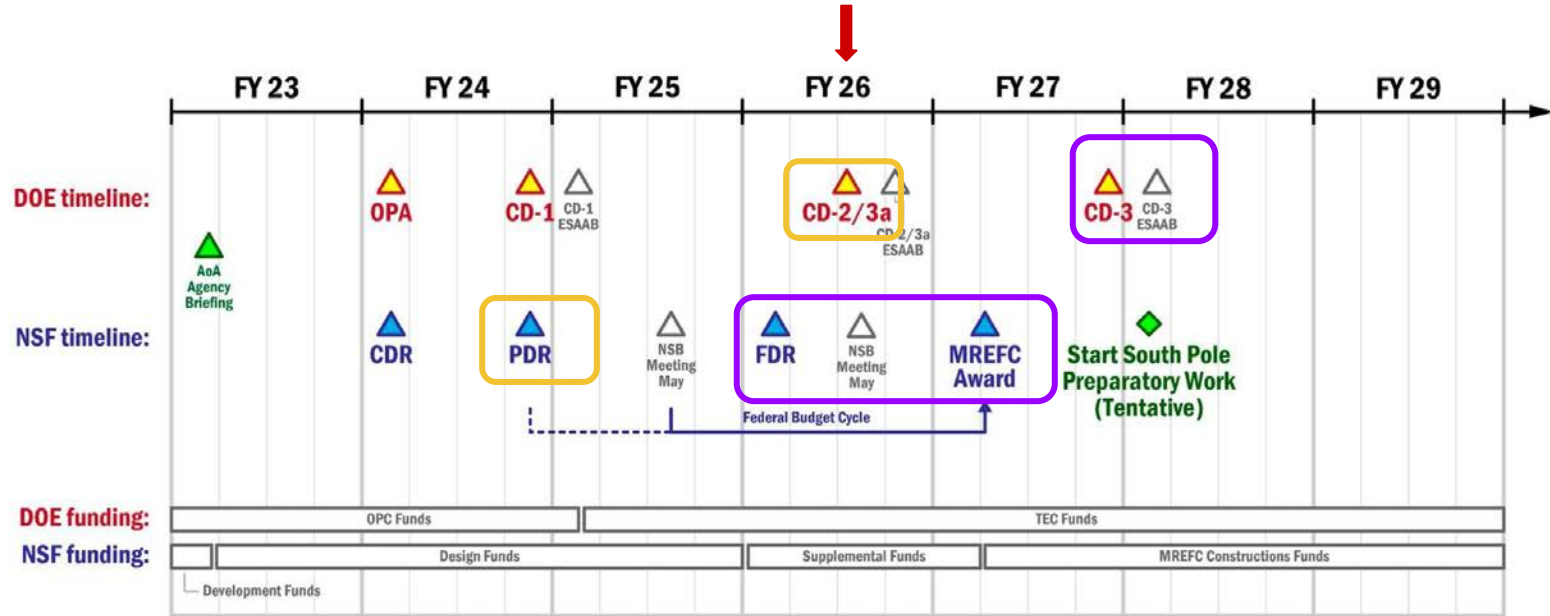



 CD1 DR1

Current Status (1)

Technical Areas Continue To Accomplish Major Design Advancements

Wiring vacuum feedthrough

New 300K Electronics

300K

50K

DR frame

Wiring looms

4K SSA and addressing PCBs

1K

100 mK readout module

100 mK

~ 1m

Cold Load

MUX+NYQ+TES

Current Status (2)



Technical Areas Continue To Accomplish Major Design Advancements 

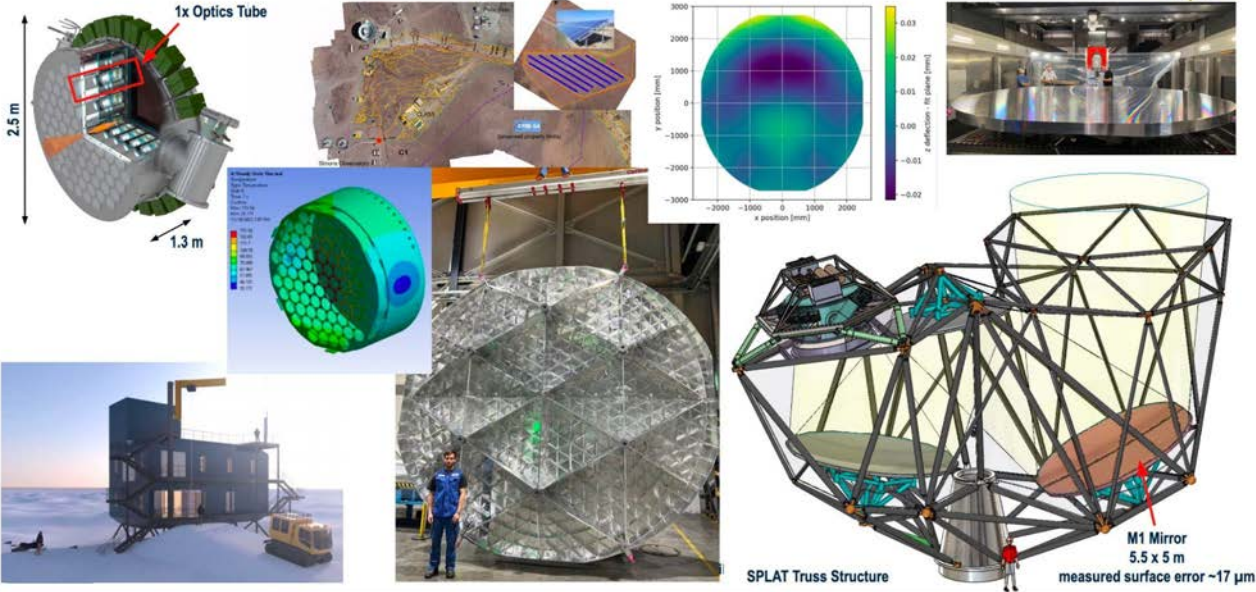

1x Optics Tube
2.5 m
1.3 m

x-deflection: 10 plane (mm)

M1 Mirror
5.5 x 5 m
measured surface error ~17 μm

SPLAT Truss Structure

The field/context (major/funded expts)

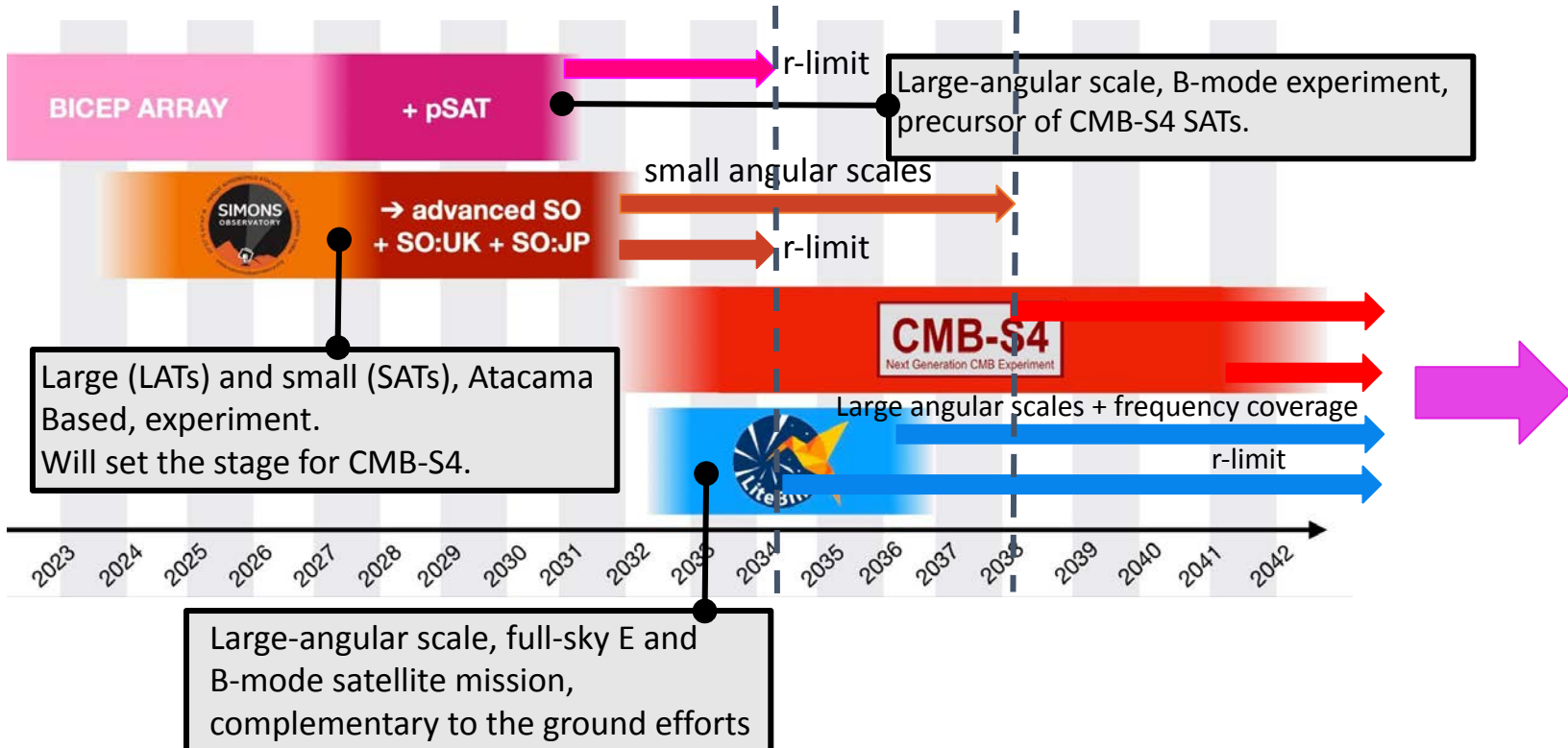

CMB-S4@IN2P3



- Individual-level involvement since 2015 (~5).
 - Contributions to the experiment design and the science case.
- Internal, regular IN2P3-wide discussions and teleconferences since 2019.
- Letter of interest sent by the IN2P3 direction to the CMB-S4 Project Office on the behalf of the CMB-S4@IN2P3 group in 2021
- Direct discussions with the CMB-S4 Project Office Managers to identify areas of common interest and potential contributions.
 - Work towards an MOU (CRADA) with the CMB-S4 Project Office (to converge later this summer).
- In-person and remote meetings with the L2 leads, including a meeting with the RO L2 at SLAC in November '22.

4 Laboratories: APC, IJCLab, LPSC, CPB

~30 researchers/research engineers

Potential IN2P3 involvement



- Ensure our significant presence (on the institutional) in the scientific exploitation of the CMB-S4 data sets ~2035-2045.
- Capitalize on the long standing expertise and experience at IN2P3:
 - Readout: QUBIC, ATHENA, Concerto, ...
 - DM: Planck, POLARBEAR, ACT, NIKA, Simons Observatory, LiteBIRD ...
- Contribute to both the collaboration work (“best-of-effort”) and the project work (formal commitment).
 - Project work: ‘In-kind’ contributions (project cost offsets) -> data rights in the proprietary period.
- Focused : two major Level 2 tasks of the WBS: 1.04 Readout and 1.09 Data Management.
- Immediate plan fo the initial 3 year period in preparation of the long-term involvement all the way to the deployment and beyond.

Potential IN2P3 contributions

CMB-S4 Collaboration meeting (remote)
April 3-6, 2023

1.09.02 Highlights

- Coordinating with Simons Observatory & REUNA on Chile site connectivity, leading to multiplexed path to ALMA and beyond.
- Discussion on software registration/replication/archiving about repurposing their software (eg. RUCIO + AMI from ATLAS and others)
 - Potential French partnership on AMI
- Prototype CMB-S4 data portal stood up
- Google Earth image showing planned fiber path from ALMA to Cerro Toco.

Note: The text 'Potential French partnership on AMI' is circled in red in the original image.

Superconducting Flex Cables Are Being Developed at Hightec And CEA/France

80 NB trace pairs at 140 um pair pitch (70 um trace pitch)

Flex prototype from Hightec in characterization setup. Wirebonded by FNAL. Low yield because of over-etching (will be addressed in next run)

Performance: Superconducting ~ O(10) μ Ohm residual resistance at 4K, but critical current low in this run.

Next prototype run planned (US procurement, CEA vendor management and measurements).

Julian Bonfil (daphni) to Everyone 12:08
@Gregg How much computing do you need? We might be able to find some NESC time.

Katie Harrington to Everyone 12:13
with OCS you just need to write an agent to run each device

Ex: S0 has "agents" that run/write data for FTS

S4 will need similar

Exploring Drop-In ASIC For Analog Front-End With IN2P3/France

ASIC designed for Athena (APC) with 7000 channels per chip.

Potential drop in for: 200K LNA, 4K SSA bias, 100mK SQ1 bias

- Differential
- Low 1/f noise
- Thermal drift compensation

Exploring form factor (APC + APC) and compatibility with proto electronics:

- BGA-like packaging and integration
- Design of a daughter board with 4 ASICs to be integrated in proto electronics.

Potential IN2P3 contributions - projected FTEs



person-year(*)	07/2023-07/2024	07/2024-07/2025	07/2025-07/2026
TOTAL	4	5.25	5.3
DM	1.5	2.75	2.5
READOUT	1	2	1.5
COLLABORATION	1.5	0.5	1.3

(*) only permanent (researchers+research engineers) and fully funded postdocs

A total of 12 FTEs of the Project work during the period of 3 years.



IN2P3 support

The proposed plans cannot be implemented without significant and active support from IN2P3.

Including human resources:

- postdoctoral researchers; (there are three (1 current and 2 forthcoming) at this time).
- PhD students (3 part time).
- engineers (software and electronics); (needed basically from now)
- permanent researchers to support the CMB research on some regular basis.

Mostly collaboration

In the second phase (2026+) funding support depending on agreed level of involvement.





Proposed IN2P3 DM contributions to CMB-S4



DM Breakdown

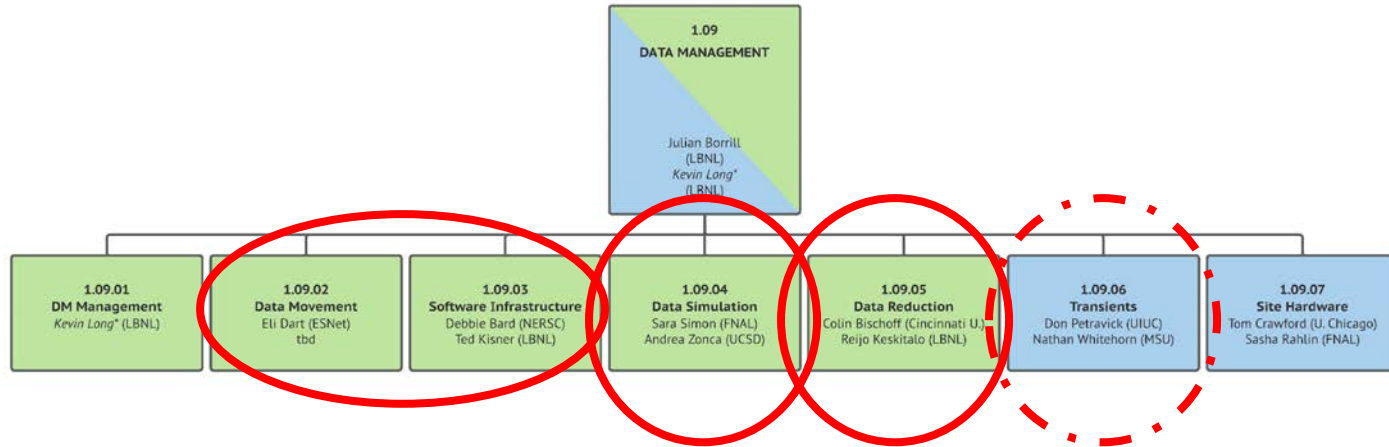

Currently discussed:

- 1.09.02. Data Movement
- 1.09.03. Software Infrastructure
- 1.09.04. Data Simulations
- 1.09.05. Data Reduction

More long term:

- 1.09.06. Transients

IN2P3 contributions: 1.09.02 and 1.09.03

Data movement (1.09.02) and **Software infrastructure** (1.09.03) – these tasks cover all data storage and (local) data movement infrastructure for the project work and the collaboration. Led by Ted Kisner (LBL) and Debbie Bard (NERSC) at the Project Office level.

Our potential contributions:

- implementing the Atlas Metadata Interface (AMI) for tracking and managing the CMB-S4 database on the metadata level, (LPSC)
- porting and adapting RUCIO as an actual data movement tool originally developed for ATLAS.

Specific, level 4 and 5 tasks covering these contributions are:

- Registration for Data Movement, 1.09.02.01;
- Data and Metadata Indexing, 1.09.03.01.3;
- Tracking of Workflows and Data Products, 1.09.03.04.2.

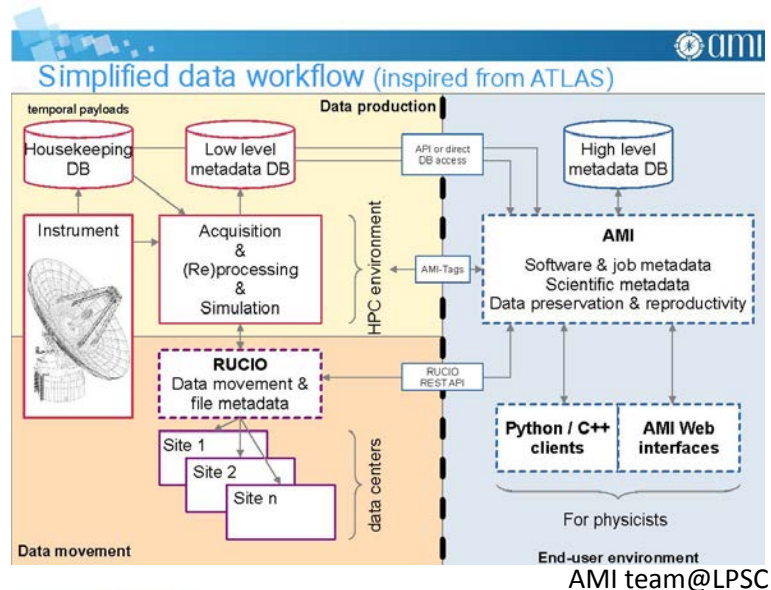

IN2P3 contributions: 1.09.04



Data Simulations (1.09.04) – development and implementation of progressively more realistic, in terms of data volumes and complexity of numerical tools, and production of data sets with increasing level of realism to validate design choices, set requirements, and demonstrate data analysis tools.

This effort is led at the Project Office by Andrea Zonca (UCSD) and Sara Simon (Fermilab).

The specific areas we plan on contributing to are:

- development, implementation and validation of new sky, realistic sky models;
- development, implementation and validation of numerical modules simulating instrumental effects.

These correspond to WBS Level 4 tasks: 01.09.04.02-04.

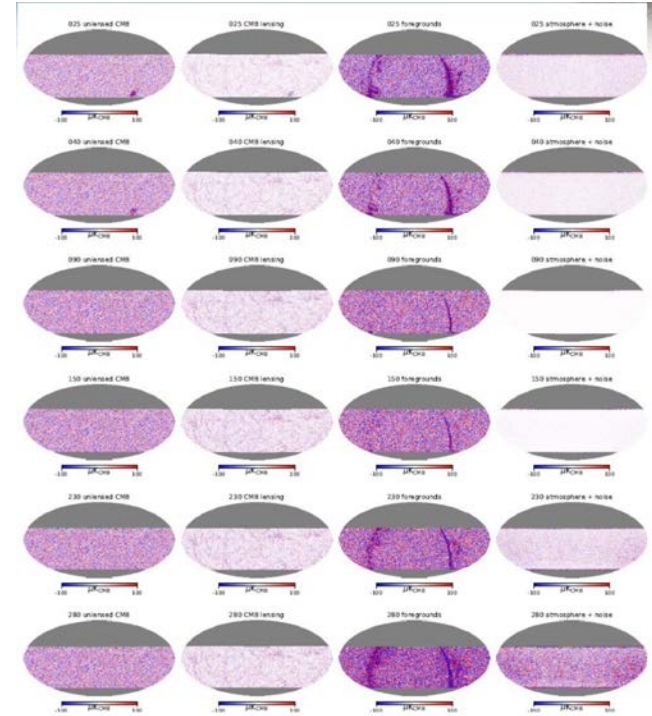

IN2P3 contributions: 1.09.05

Data Reduction (1.09.05) – development and implementation of progressively more capable, precise, and efficient numerical tools for characterization of the raw CMB-S4 data and of reducing them to more manageable, pixel-domain objects, together with their sufficient statistical characterization, including residual systematic effects.

The leads of this effort are Reijo Keskitalo (LBNL) and Colin Bischoff (Cincinnati).

The specific contributions we envisage here include:

- development, implementation, and validation of new generalized map-making techniques and codes, including methods for statistical characterization of all the derived pixel domain products;
- development, implementation, and validation of new techniques for systematic effects mitigation;
- application of the developed tools to the project-wide Data Challenges as those become available, starting with DC0 which will become available this summer.

These contributions correspond to the level 4 tasks 1.09.05.03 and 1.09.05.04 in the WBS. We expect to play eventually coordinating role on some of these tasks.

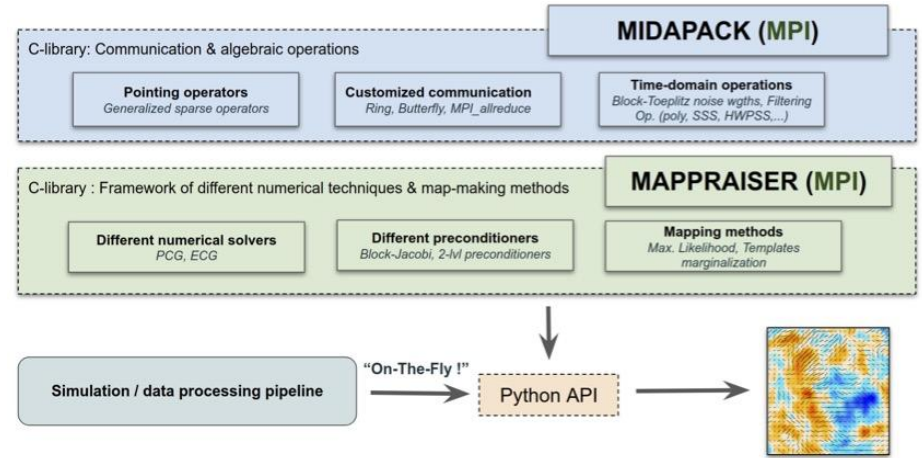

IN2P3 contributions: others

Transients (1.09.06):

The real-time event detection software, FINK7, (J.Peloton, IJCLab). FINK is one of the leading so-called brokers, selected for use by Rubin Observatory and is currently validated on data of Zwicky Transient Factory.

The proposed work would include extending the software to allow for an efficient, candidate event; determination in microwave band and porting and maintaining it in the CMB-S4 software infrastructure.

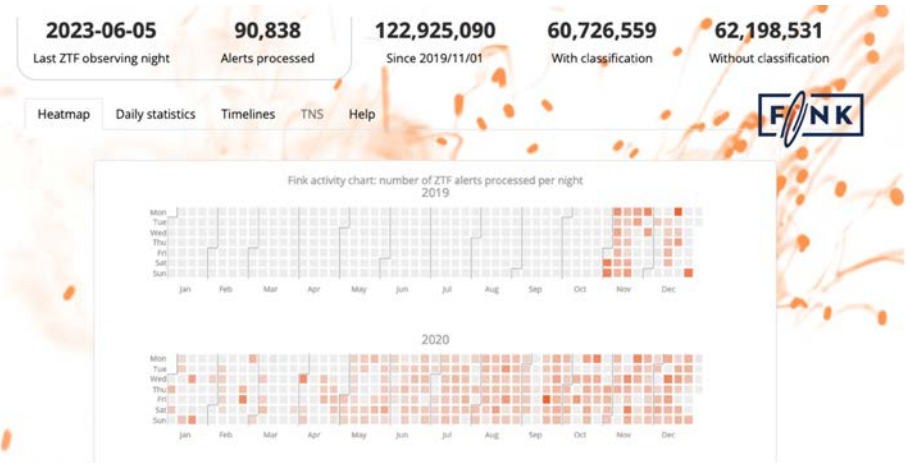

IN2P3 contributions: Collaboration work

Low-ell BB: working toward developing tools and techniques appropriate for the B-mode detection, using predominantly data from Small Aperture Telescopes envisaged to operate from the South Pole. The work of this AWG will be a key for constraining the physics of inflation and therefore fundamental physics laws at the extremely high energies.

Maps to power spectra: working on techniques and software for CMB power spectrum estimation and targeting Large Aperture Telescopes (high resolution/large sky coverage). This AWG will play a key role in constraining the properties of relativistic particles present in the Universe, including neutrinos, and those from beyond the standard model of particle physics.

Maps to other statistics: working on higher order statistics, which will allow to improve on the constraints on inflation (via e.g., delensing and constraints on primordial non-Gaussianity) and provide clues about the nature of dark energy via characterization of the kinematic and thermal Sunyaev-Zel'dovich effects.

Clusters: studying the properties of clusters and therefore contributing to the constraints on cosmology from clusters.

Joint LiteBIRD CMB-S4 Task Force: exploring synergies between the two experiments.





CMB-S4 Instrument Description and IN2P3 Hardware contributions to CMB-S4

CMB-S4 Instrument Description after AoA

- **500 k deployed detectors** (483344)
- **363 wafers** (All wafers are dichroic except the ULF wafer)
- **3 LATs**
 - 2 x 6 m CD* Chile > 50% sky
 - 1 x 5 m TMA** Pole ~3% sky)

-> 3x85 tubes_{20cm} ; 255 wafers ; 400 k detectors

- 200 TES ULF; 5k LF; 280k MF; 120k HF

- **3 SATs**

-> 3x3 tubes_{50cm}; 108 wafers ; 80 k detectors

- 500 TES LF; 40k MF; 40k HF

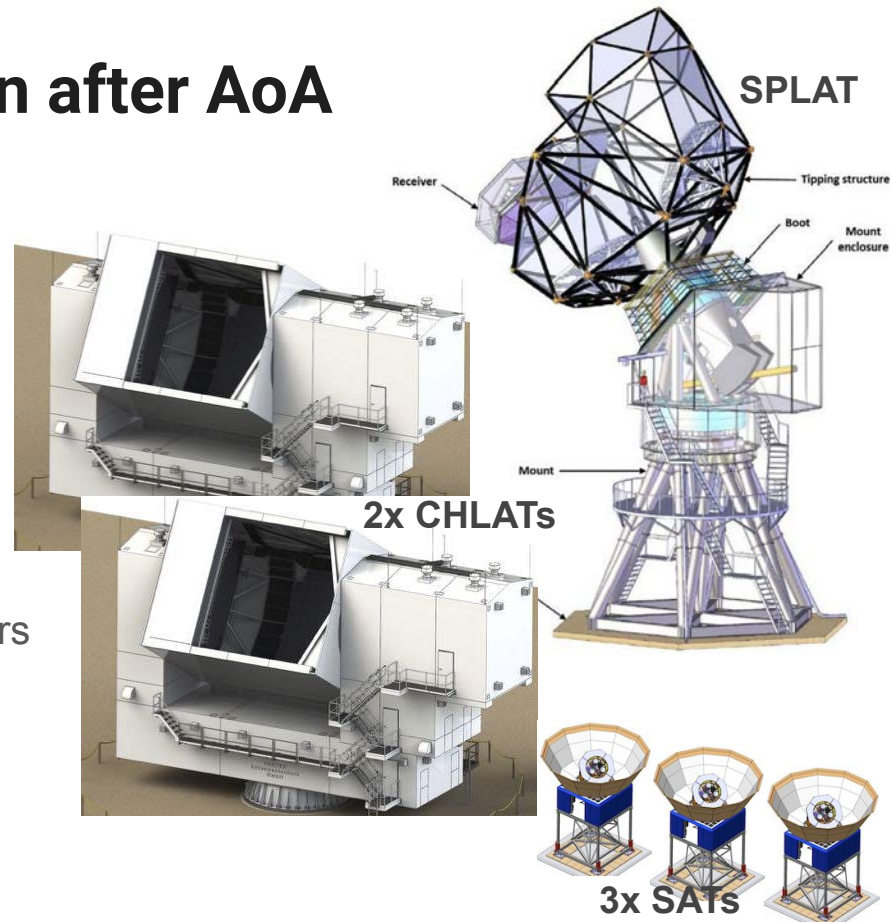

[1] Large Aperture Telescopes Update - M. Niemack

[2] <https://cmb-s4.org/experiment/>

*CD - high-throughput off-axis crossed-Dracone

**TMA - five-meter diameter three-mirror anastigmatic telescope

CMB-S4 LAT and SAT receiver cryostat design

LAT - Large Aperture Telescope

SAT - Small Aperture Telescope

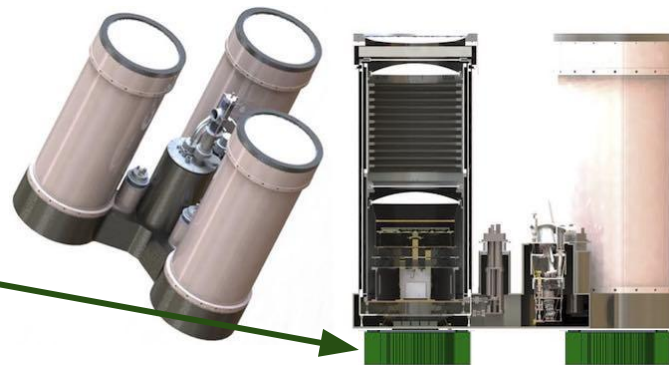
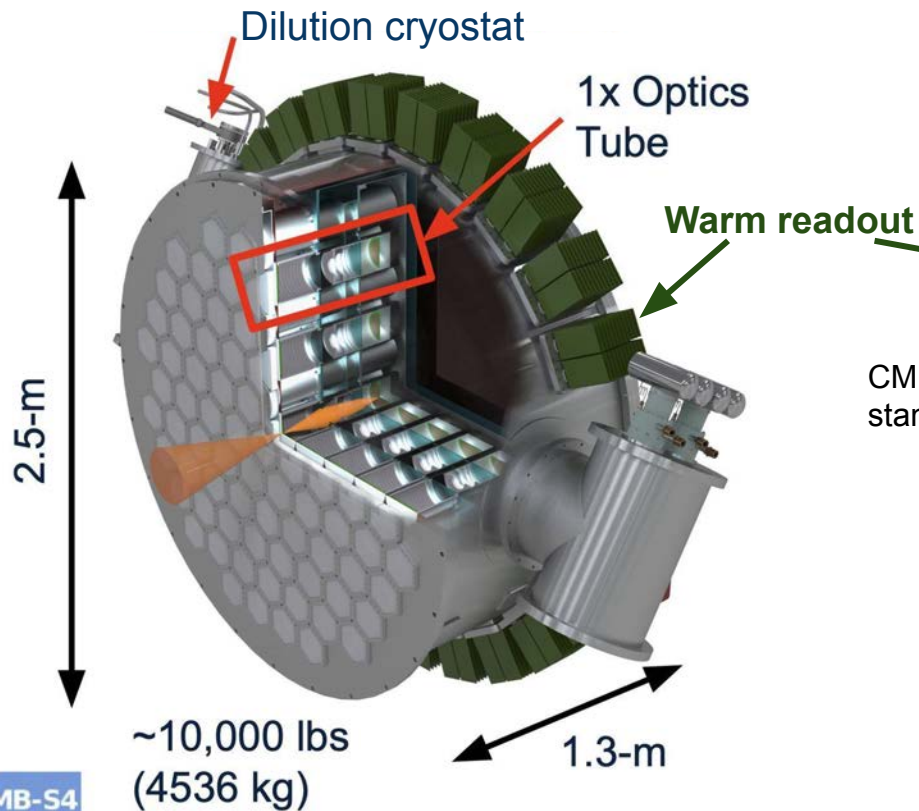

CMB-S4 tubes, detection chain and interfaces must respect S4 standards different from the SAT and LAT SO :

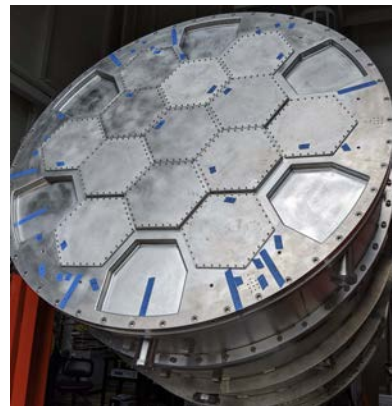

Polarization sensitive & Multi-Chroic concept

6 mm

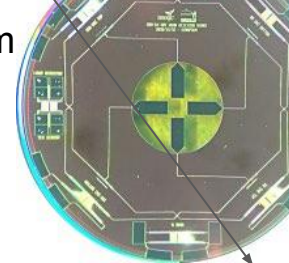

Sky Signal spline-profiled Horn* array

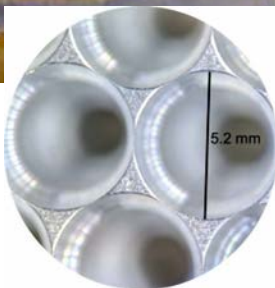
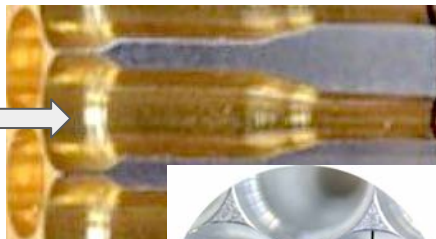
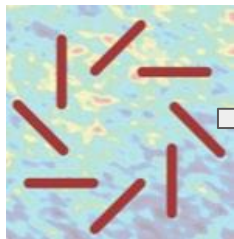

Interfaces layers**

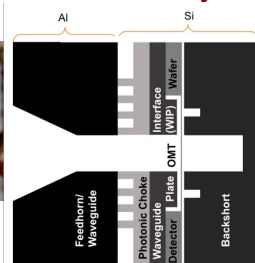

OMT***

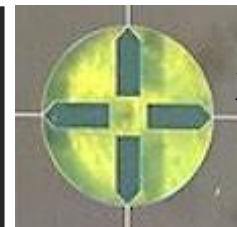

Diplexer****

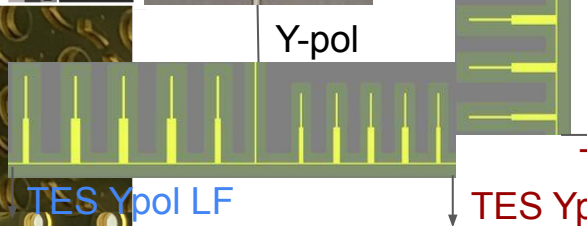

TES Xpol HF

TES Xpol HF

TES Ypol HF

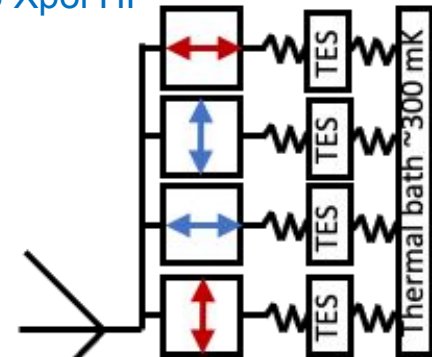

- Sensitive to **polarisation** antenna
- Superconducting **Channelizer** / Diplexer
- End line **dissipator** + Thermalization
- **Bolometer** + Superconducting thermometer

*Feedhorn dev. and scalability for SO and beyond - S. M. Simon et al.

** Conceptual Design ...for the CMB-S4 survey experiment, D. Barron et al.

*** JLTP 2022 DOI: 10.1007/s10909-022-02731-x

****Multi-Chroic Detectors for Observing the CMB - A. Traini, M. Piat et al.

Transition Edge Sensors

- Quadratic detection at the line end
- Bias dissipation $\rightarrow P_J = V_{\text{bias}}^2 / R_{\text{TES}}$
 - auto adjustment in an array @ T_c
 - response homogenisation response
 $\partial I_{\text{TES}} / \partial P_J = 1 / V_{\text{bias}}$
 - Improve time response $< C/G$

Strong Electro Thermal Feedback - ETF

**\rightarrow Voltage biasing
= detection transfer function**

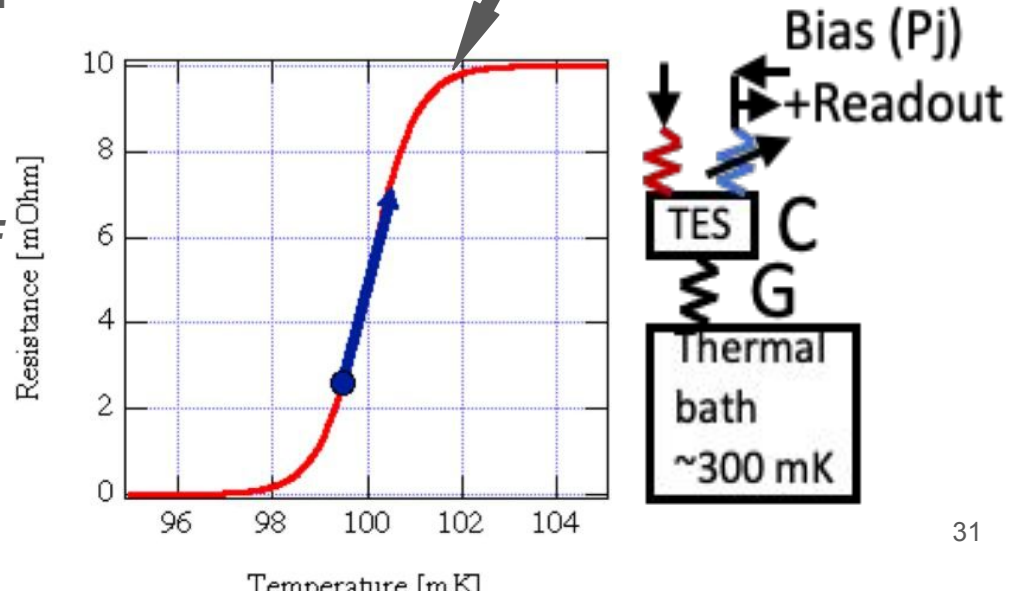
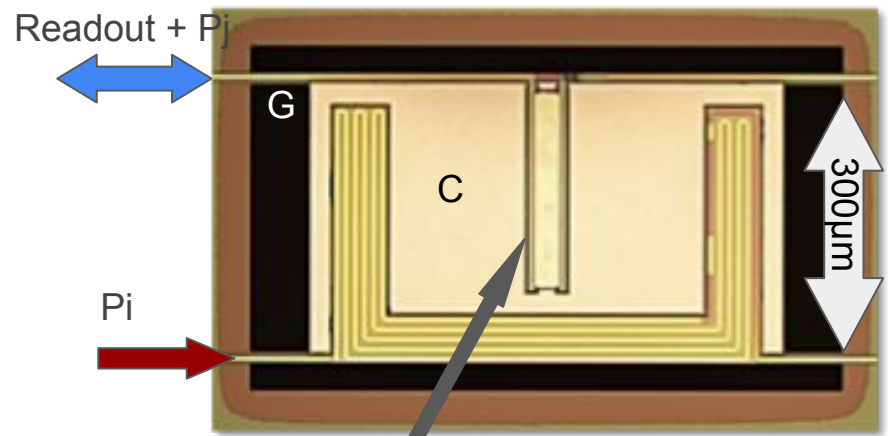

TES : polarisation sensitive + multichroic

6 fabrication sites : NIST, Argonne, UCB, LBNL/SQC, JPL

SAT : 30/40 GHz, 85/145 GHz, 95/155 & GHz 225/278 GHz

LAT : 20 GHz, 30/40 GHz, 90/150 GHz & 225/278 GHz

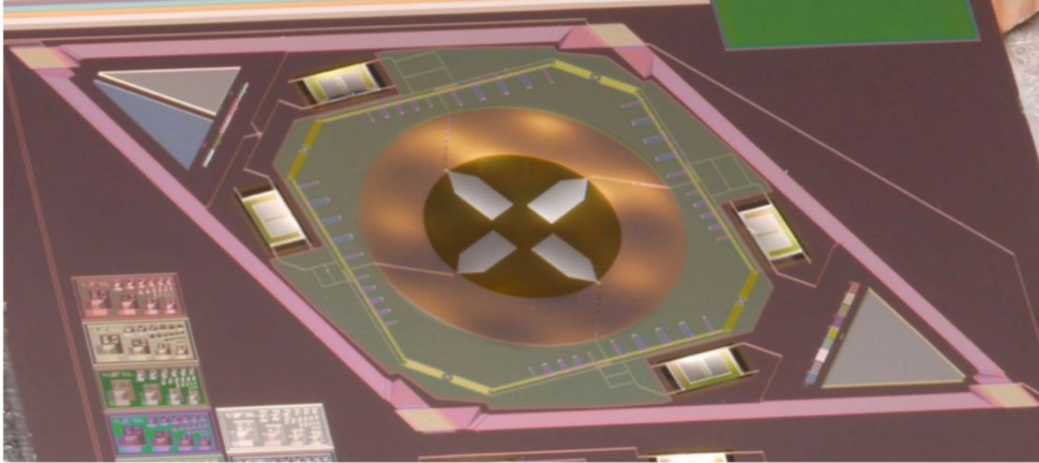
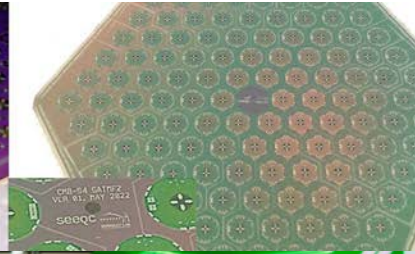
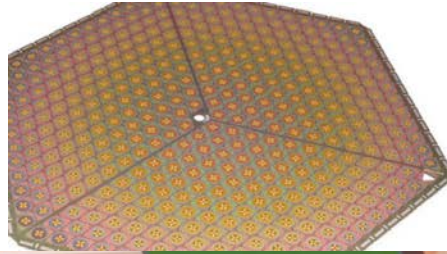

CMB S4 detection chain : TES + SQUID TDM + warm readout

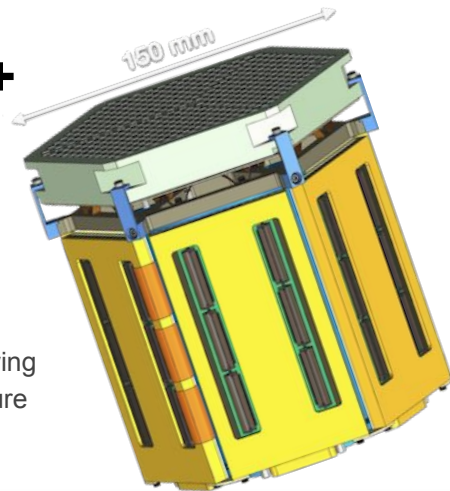

SQUID amplification and multiplexing circuit for one TDM readout column (SLAC responsibility):

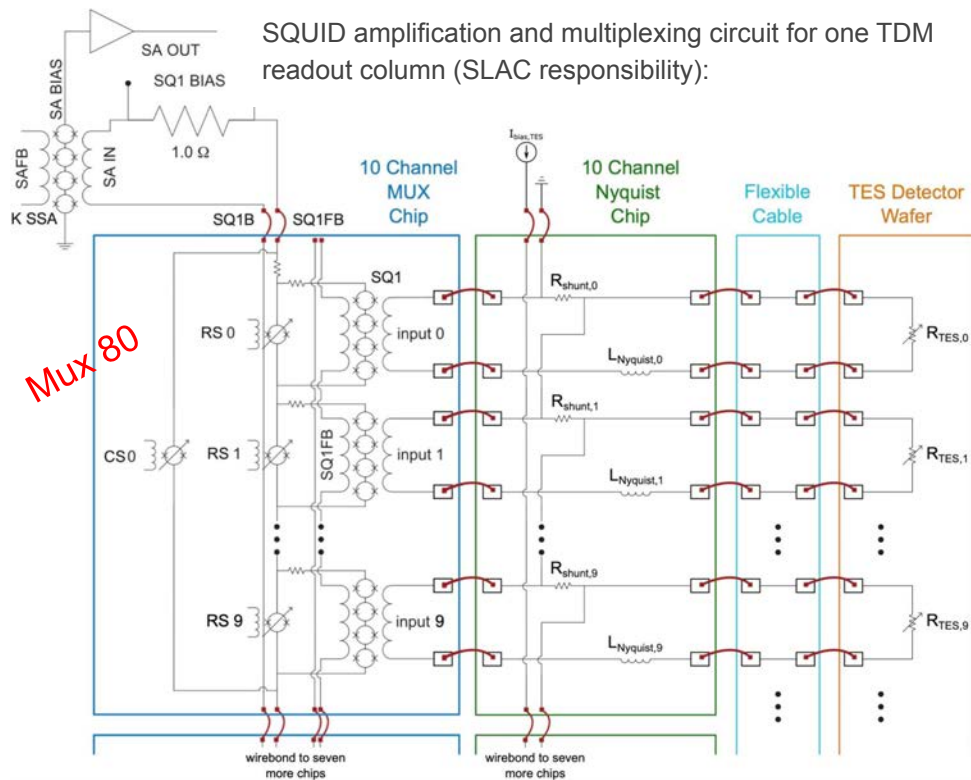

Modular readout scheme showing components at each temperature stage and interconnects :

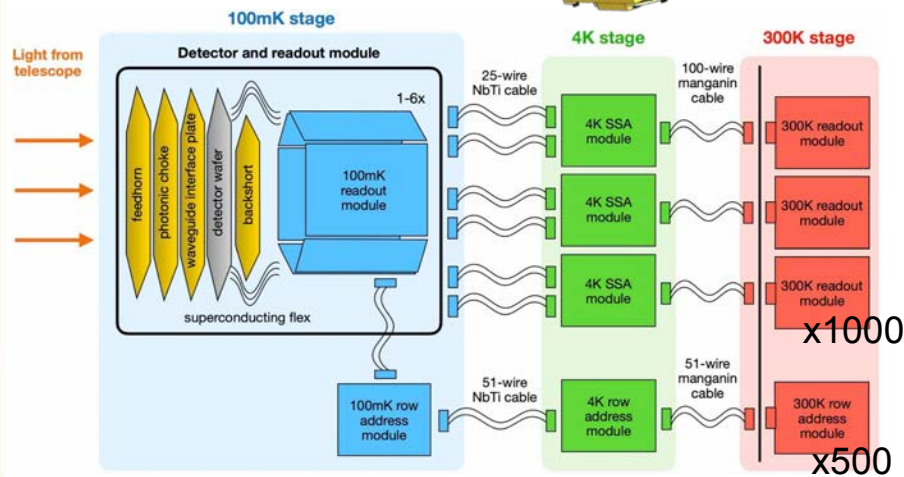

100 mK readout

[readout] CMB-S4 Readout WG Telecon every 2 weeks

- NIST SQUID fabrication
- SLAC assembly
- Test :
 - UIUC
 - FNAL
 - UNM
 - SLAC

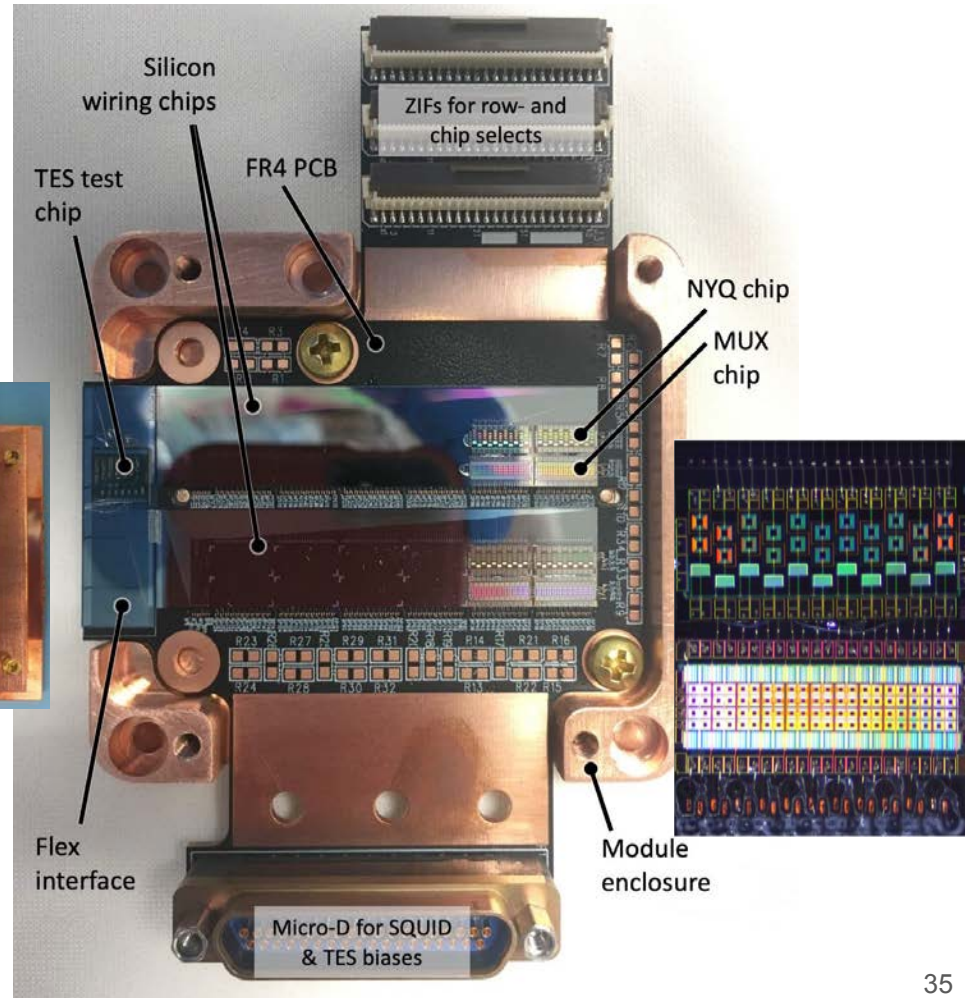
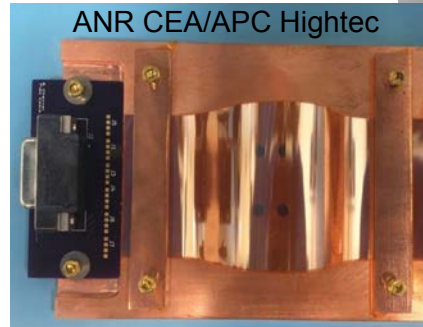
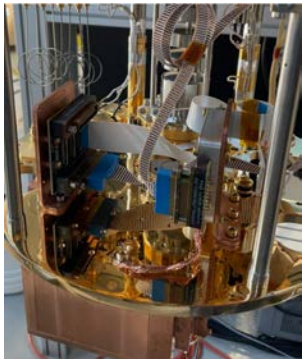

Current cryogenic detection chain

Flat assembly

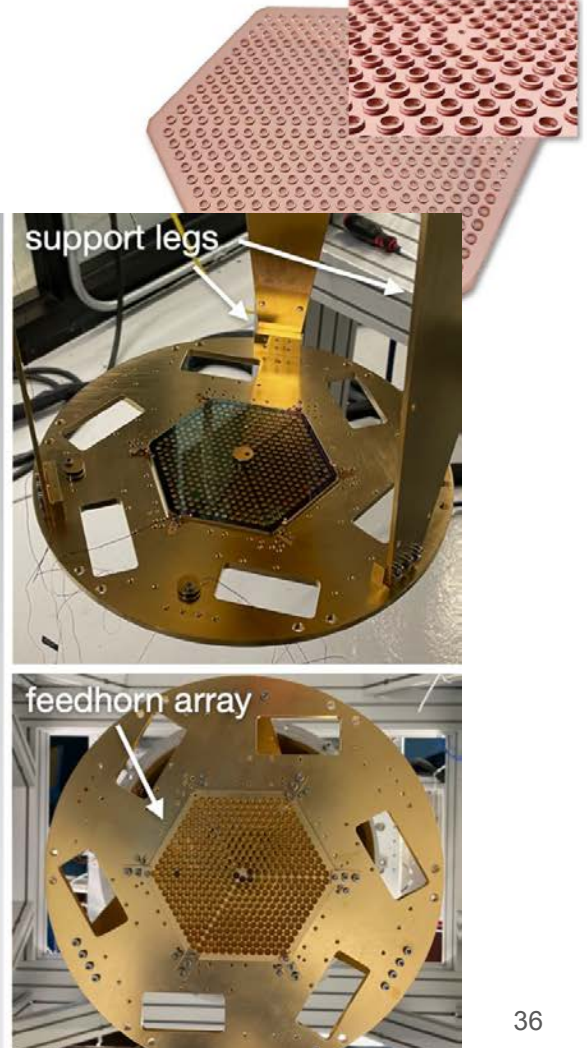
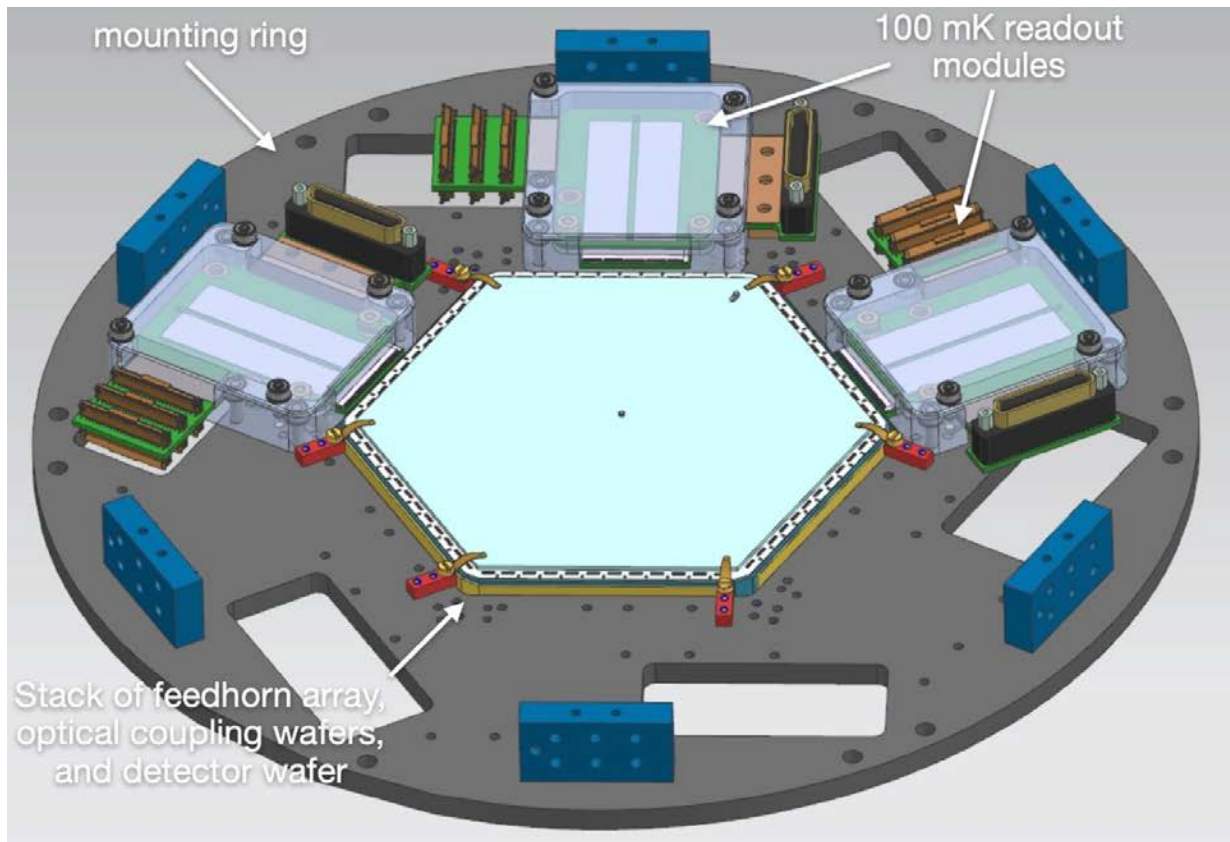

Warm readout : front end outside the cryostat

First row revision SLAC (evolution of MCE) Basic functionality (performances must be consolidated)

Readout : ultra low noise amplification and SQUID/TES bias

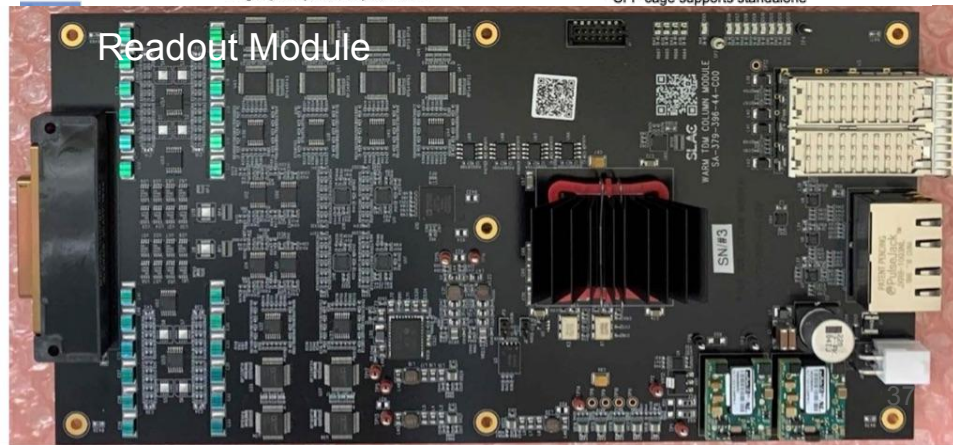
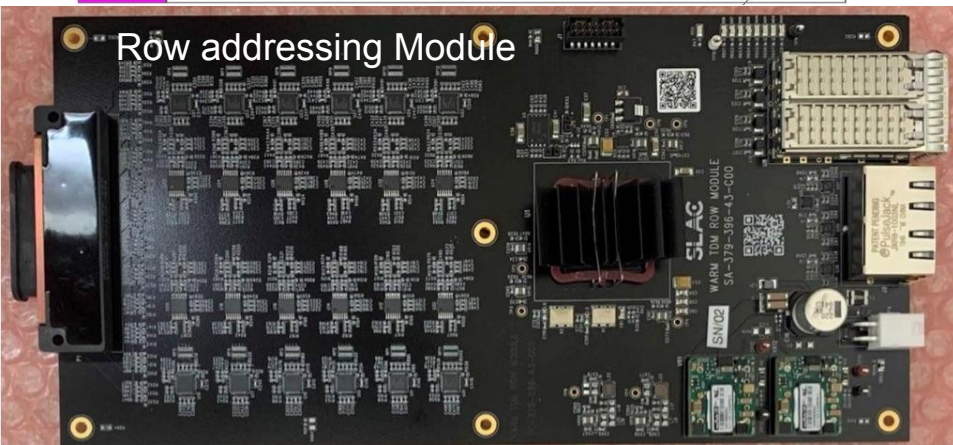
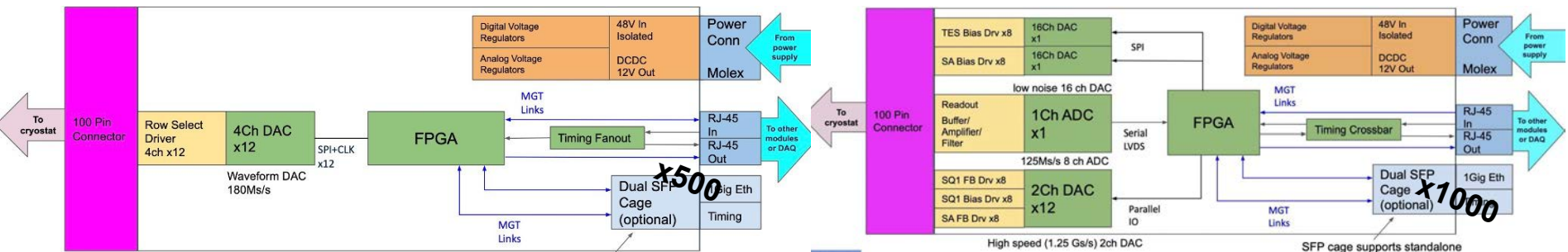

Use of integrated circuit for front-end analog readout



Specific Integrated Circuit for the X-IFU Warm Front-End Electronics

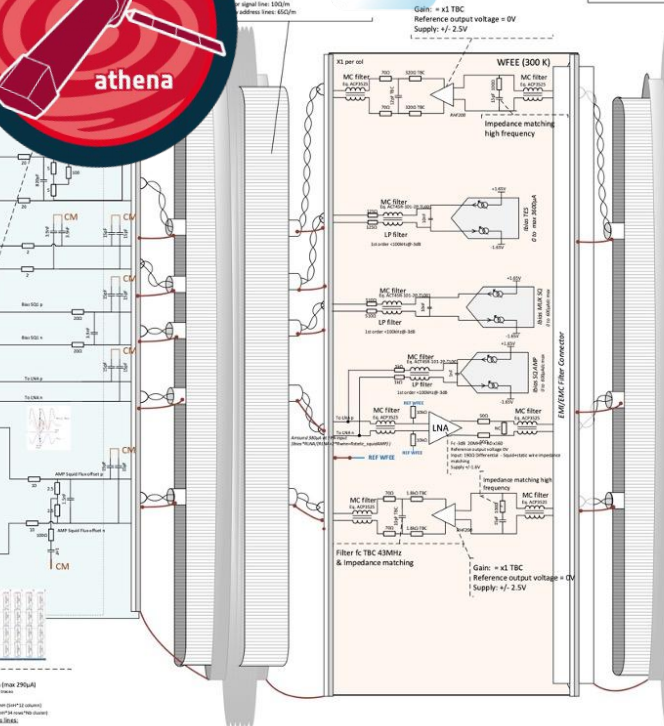

Damien Prêle (APC, Paris) on behalf of the WFEE and X-IFU detection chain team.

The X-IFU (X-ray Integral Field Unit) instrument of the Athena mission is designed to operate with 3168 superconducting microcalorimeters (read out by Transition Edge Sensors - TES) cooled to 50 mK, providing an imaging spectrometer for X-ray astronomy. The unprecedented spectral resolution of 2.5 eV up to 7 keV requires low noise readout electronics. Located immediately outside the cryostat, the Warm Front End Electronics (WFEE) is a key component of the readout electronics.

The WFEE amplifies the detection chain signal, adjusts the operating points of the cryogenic devices (Superconducting QUantum Interference Devices - SQUIDs), and feeds through the TES bias and feedback loop. Using Frequency Domain Multiplexing (FDM, see Athena Nugget #28 for more details), 40 microcalorimeters are read out per channel and 40 carriers between 1 to 5 MHz are injected to 40 sensors. As a result, the detected X-ray pulses are transposed into 40 different frequencies. Ultimately, about one hundred channels are needed for the full readout of the TES array.

To meet the energy resolution of the cryogenic sensors, the WFEE, like the whole readout chain, has to exhibit ultra-low noise and extremely small gain-drift. At the same time, the size, the mass, and the dissipation must be minimized as required for a space mission. For this reason, an Application-Specific Integrated Circuit (ASIC) has been designed for the WFEE. "350nm BiCMOS SiGe" ASIC technology is used for the core of the WFEE. "BiCMOS" means that both bipolar transistors and complementary (N and P) MOS transistors can be built using this technology. Finally, "SiGe" indicates that Silicon-Germanium alloy is used to make the base-emitter junction of the bipolar transistor. Such a hetero-junction increases the speed of the transistors allowing the design of a wide-band amplifier covering the frequency range of the carriers used for the FDM. The micro-photograph illustrates an ASIC chip design for the WFEE. Eight independent readout channels will be integrated on a chip of one square centimetre.

The noise degradation of WFEE is minimized by reducing any parasitic resistance and thanks to fine-tuning of the transistors biasing to operate in an optimal noise condition.

The gain drift is also a significant contributor to the energy resolution budget. At large time scale (> 1s), the thermal drift is the main cause of electronic parameter shifts. The entire circuit is based on a specific design including thermal compensation techniques.

The WFEE with its custom designed ASIC is a compact, light-weight component with minimal power consumption and it delivers the high performance required for Athena's X-IFU readout electronics.

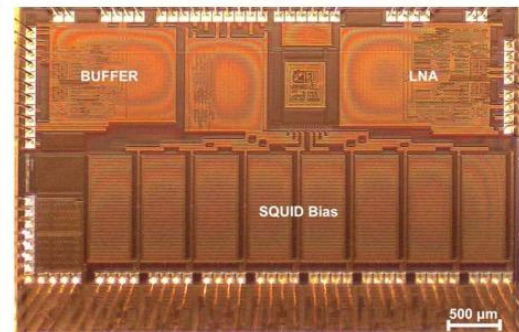

Micro-photograph of one WFEE readout channel in an integrated circuit: *AwaXe_v2.5*. The figure shows the LNA (Low Noise Amplifier) to amplify the multiplexed signal; the Buffer to drive the biasing of the sensors; and finally four differential quasi-DC SQUID Bias with associated bus decoders to adjust the operating points of the readout chain. Credit: Damien Prêle.

Expected improvement with IN2P3 ASIC daughter board

- Input LNA noise <math> < 0.7 \text{ nV}/\sqrt{\text{Hz}} </math> , gain x bandwidth > 4 GHz
- Bias noise and stability
- Differential architecture \rightarrow common mode rejection
- Thermal drift monitoring
- + Compactness
- + Ease the integration



Demonstration of these improvements on a single channel + new package LPSC/APC with SLAC + postDoc IN2P3 Horacio Arnaldi

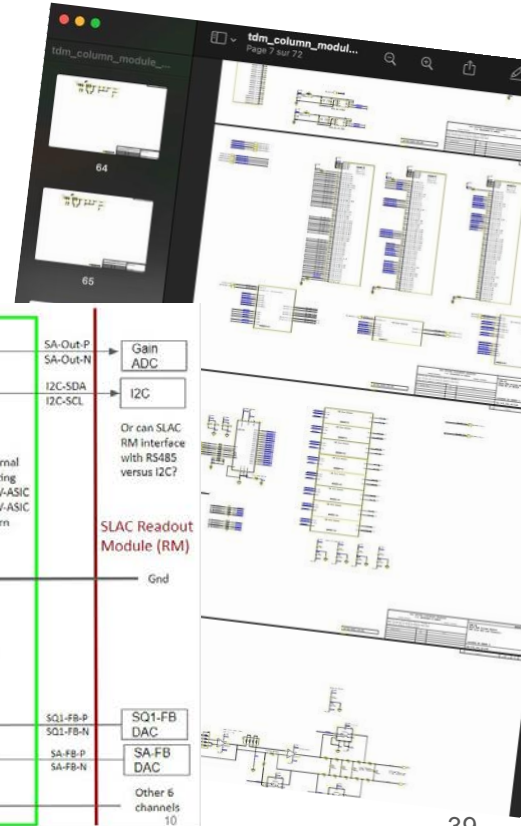
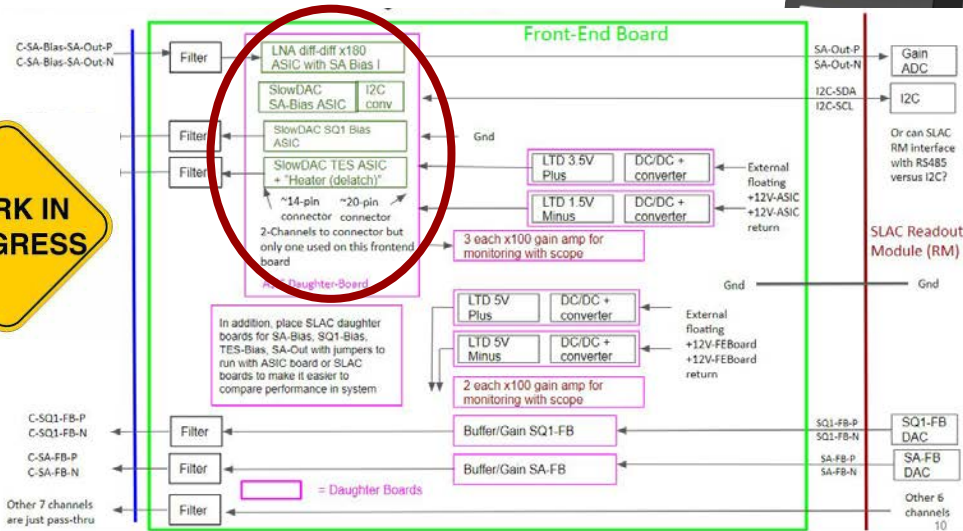

Collaboration with SLAC on the detection chain

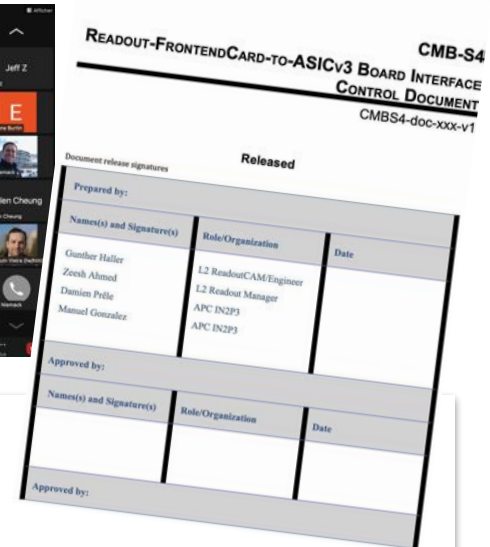
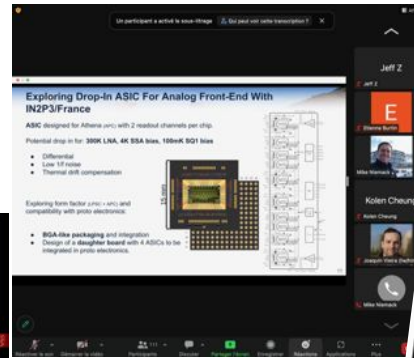
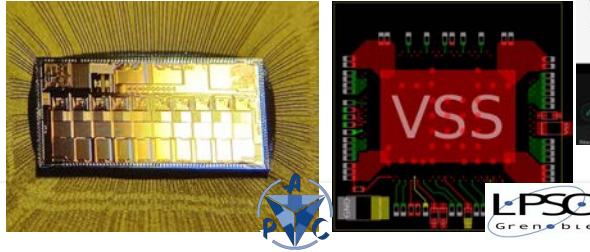

DELIVERABLES

1. WBS 1.04 Readout
 - a. DOE
 - i. Front-End module schematic/layout/fab with ASIC front-end board
 - ii. Functionality/performance test with IN2P3 ASIC daughter board with ASIC_v3 in CQFP208 package on front-end card
 - iii. Functionality/performance test with IN2P3 ASIC daughter board with ASIC_v3 in new smaller package on front-end module (same daughter board foot-print and IO)
 - iv. Modification of warm readout module (schematic/layout/fab) to incorporate In2P3 ASIC daughter board with ASIC_v4
 - v. Functionality/performance test of readout module with In2P3 ASIC daughter board with ASIC_v4
 - b. IN2P3
 - i. Schematic/layout/fab/bench test of **ASIC daughter board with ASIC_v3** in CQFP208 package for front-end module
 - ii. **Package ASIC** in new smaller package
 - iii. **Schematic/layout/fab/bench test of ASIC daughter card** with ASIC_v3 in new smaller package for front end module
 - iv. **Design/fab/test ASIC_vS4**
 - v. Schematic/layout/fab/bench test of ASIC daughter card with ASIC_vS4 in new smaller package for warm readout module.

IN2P3 labs involved in hardware for CMB S4

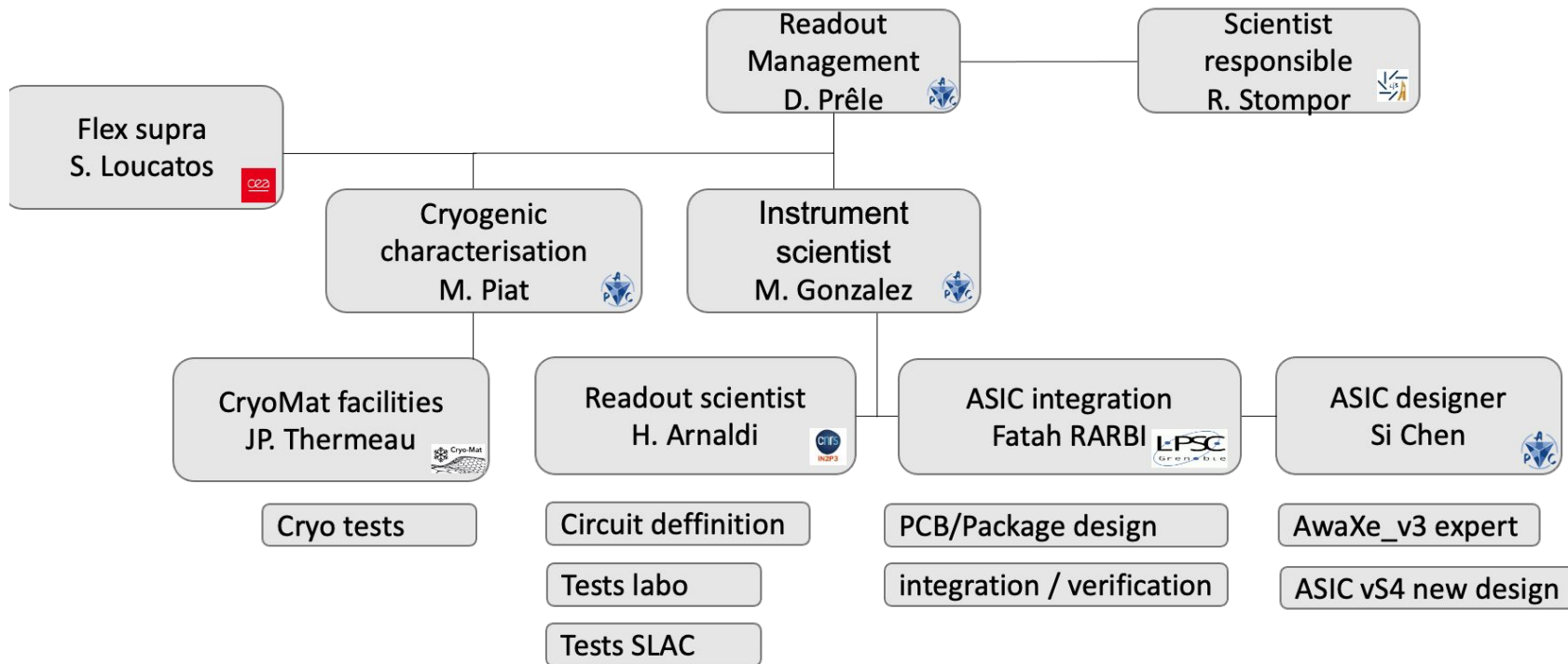

CMB S4 @ IN2P3



CMB-S4 collaboration on the instrument beyond data analysis

- Relevant expertise from past/current projects considered:
ATHENA, CONCERTO, QUBIC, NIKA2 ... PLANCK

- Strategic involvement on the long term // SO - short/mid term

Collaboration in the whole CMB-S4 instruments readout opportunity

1) need a **fast and significant involvement in the next 3 years** to guarantee our involvement in the next phase

2) need to **anticipated a more long term and massive involvement** for the productions/tests/deployment of the readouts for all the CMB-S4 instruments

– *involvement in intermediate term projects, like SO, is a complementary effort for observational data access before CMB-S4*

IN2P3 contribution to CMB-S4: summary



Strengths/opportunities

- Excellent, high-visibility, high-impact science with long lasting legacy.
- Excellent collaboration prospects and opportunities.
- Cost-effective, in-kind contributions.
- Capitalizes and adds to the expertise already within the CMB@IN2P3 team.
- Well-matched with other big-scale CMB efforts of interest @IN2P3.
- 3-year initial period to define a long-term commitment.

Weakness

- Need resources on a short timescale.
- Undefined funding sources for the post-2026 phase.

Threats

- No final funding decision in the US as of today yet.