



Présentation LISM (focus numérique)

PV. BONZOM (LISM)

Quelques exemples de réalisations

Transducteurs Imagerie US haute température
TUSHT, MUSHT

600°C
150 bars
10²¹ n.cm-2

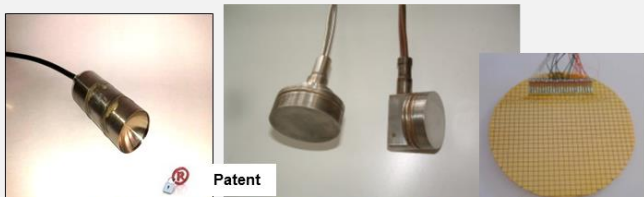

Patent

Focused Ø15mm, Plane Ø40mm and multi-elements transducers

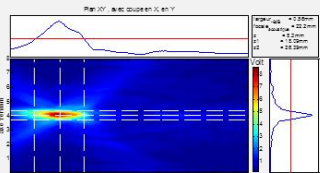

Acoustic pressure

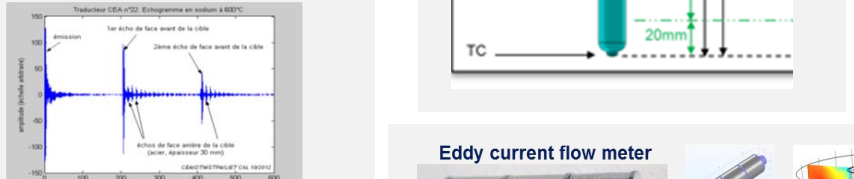

Echogram -acoustic signal

Dispositifs multiphysique
US, EM, FibreOptique,
TomolmpElec, ...

Dispositif de mesure de débitmétrie
DDF, US

Dispositifs de mesures de T°
CTD, CTS

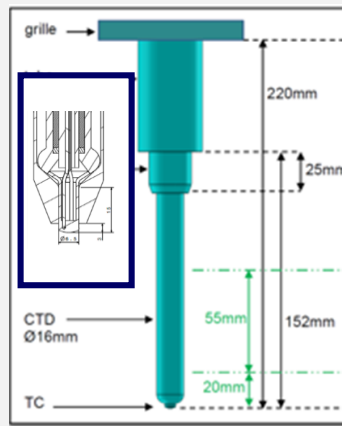

Eddy current flow meter

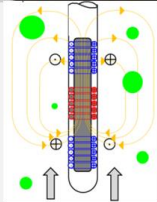

Numerical modelling

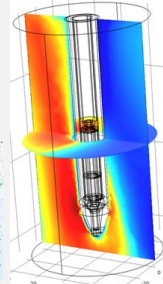
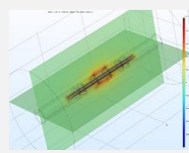

Mesures de débit d'eau par inter-corrélation bruit thermique



Data Logger sur réseau LoRa



Exemples d'applications

Contrôle non destructif
ultrasons

Ex : soudures inox. Épaises
(photos) ou inspection de
service en milieu opaque

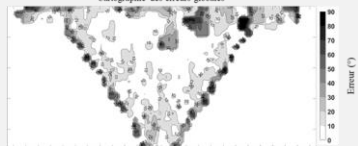
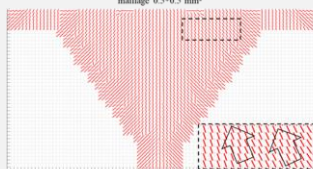
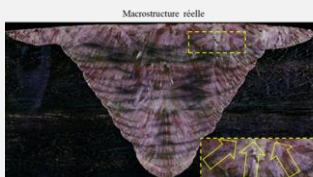
Imagerie acoustique en milieux
extrêmes

Ex : capteur acoustique (600°) +
robot de manipulation

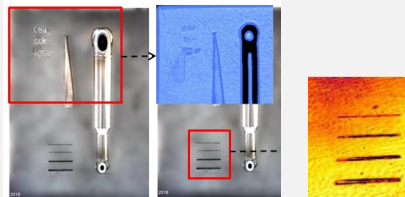
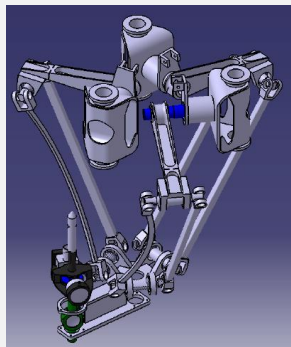

FinCoefH

Mesure de transferts
de chaleurs



ITIE

Méthode de mesure innovante qui
multiplie par 100 la résolution
temporelle pour l'imagerie

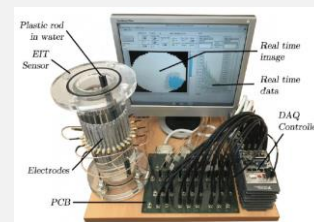

collaborations



LISM leader de la
thématique « contrôle et
surveillance acoustique »



« du capteur au traitement de la donnée »
Contribuer et s'intégrer dans la transformation numérique des réacteurs et installations nucléaires

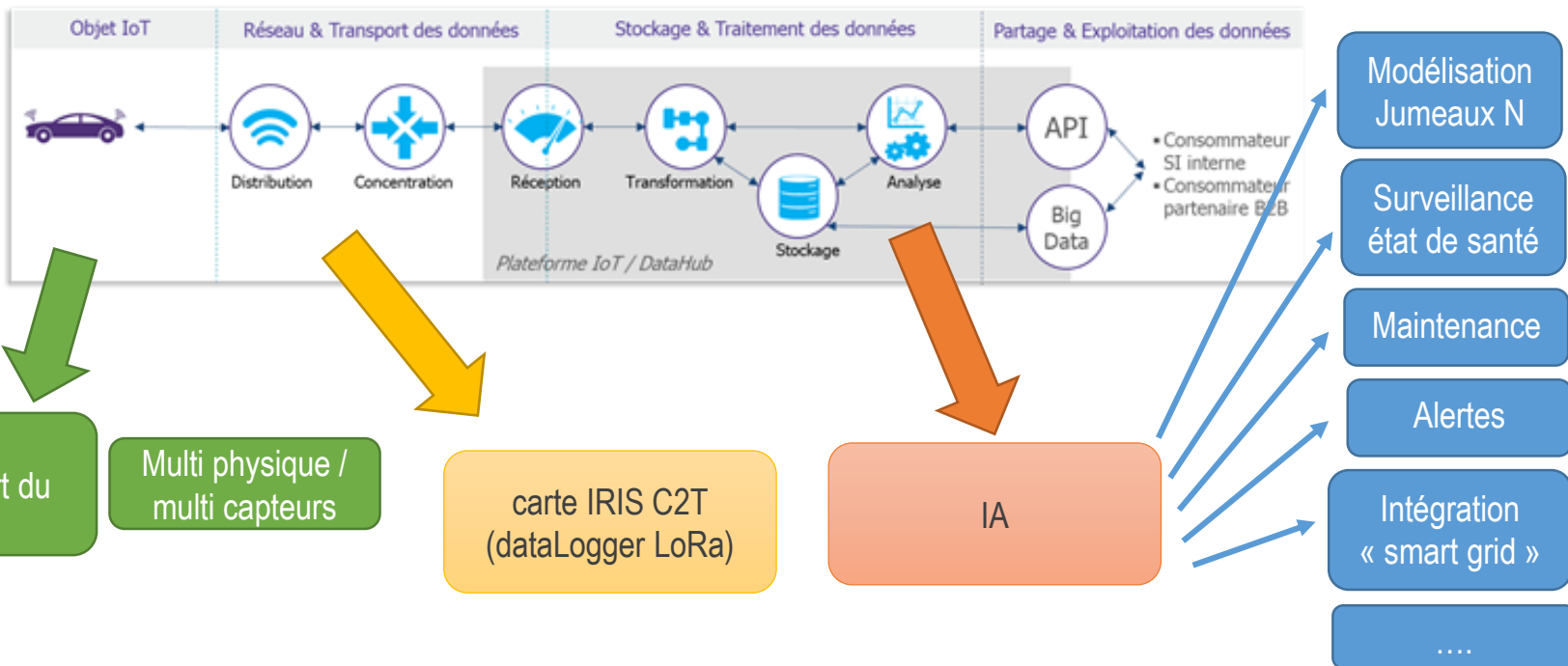

CONSTELL'EAU

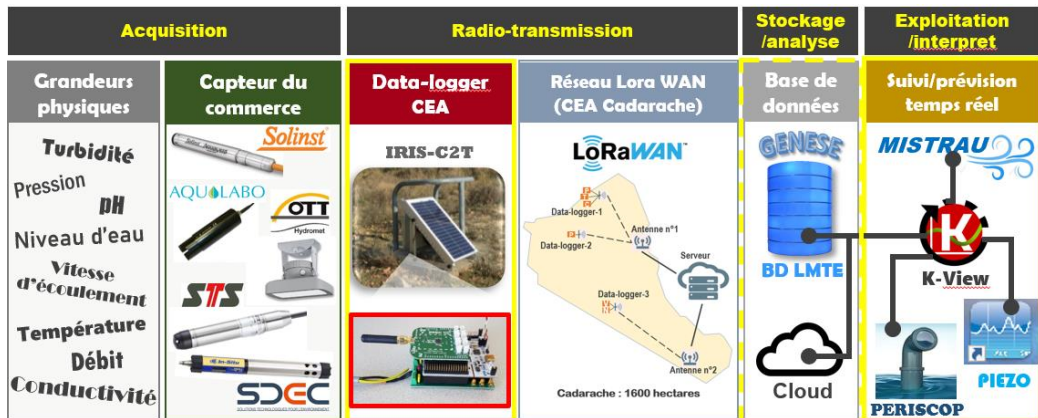

ESFR - SIMPLE

IA
 Fusion de données multi capteurs
 Détection anomalies sur boucle refroidissement

ITIE

2 thèses en IA
 Capteur tomographe par impédance électrique

Surveillance Pompe



IA embarquée (IRMA, Oxytronic)
 Maintenance préventive

MultiMod'Air

