

# Nuclear Physics Overview

## Journées de Rencontre Jeunes Chercheurs 2023

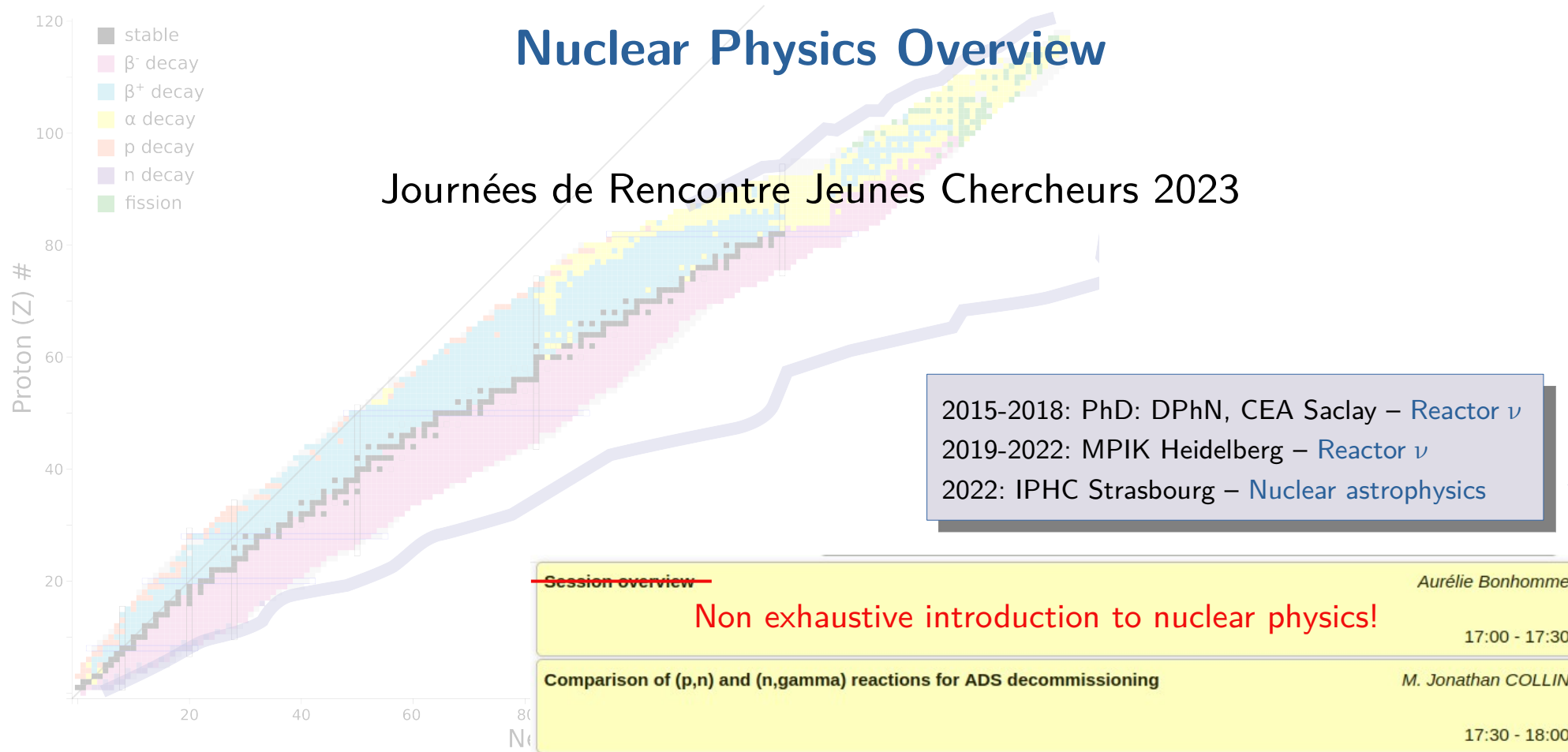

# The nuclear physics landscape

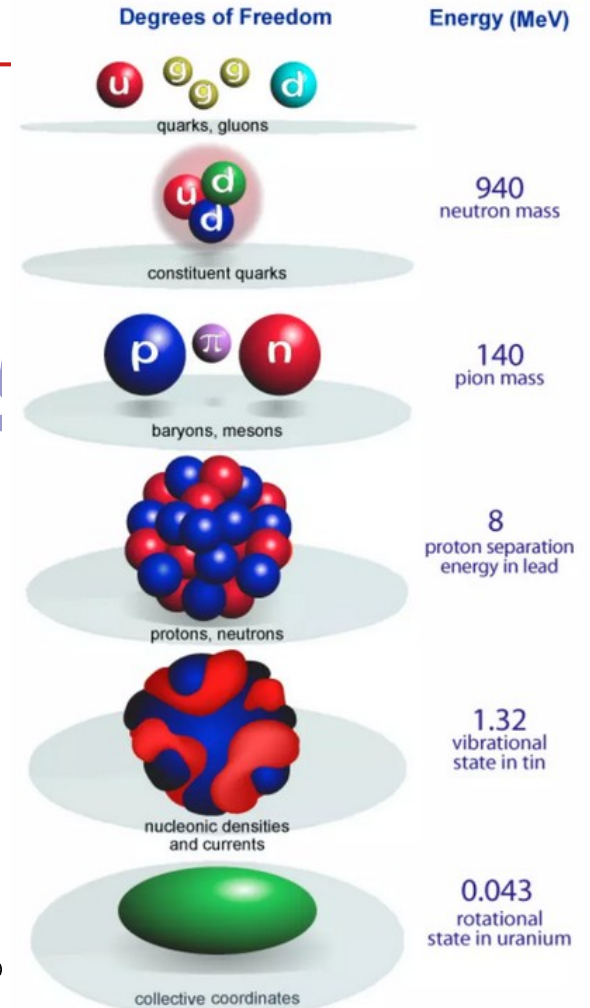
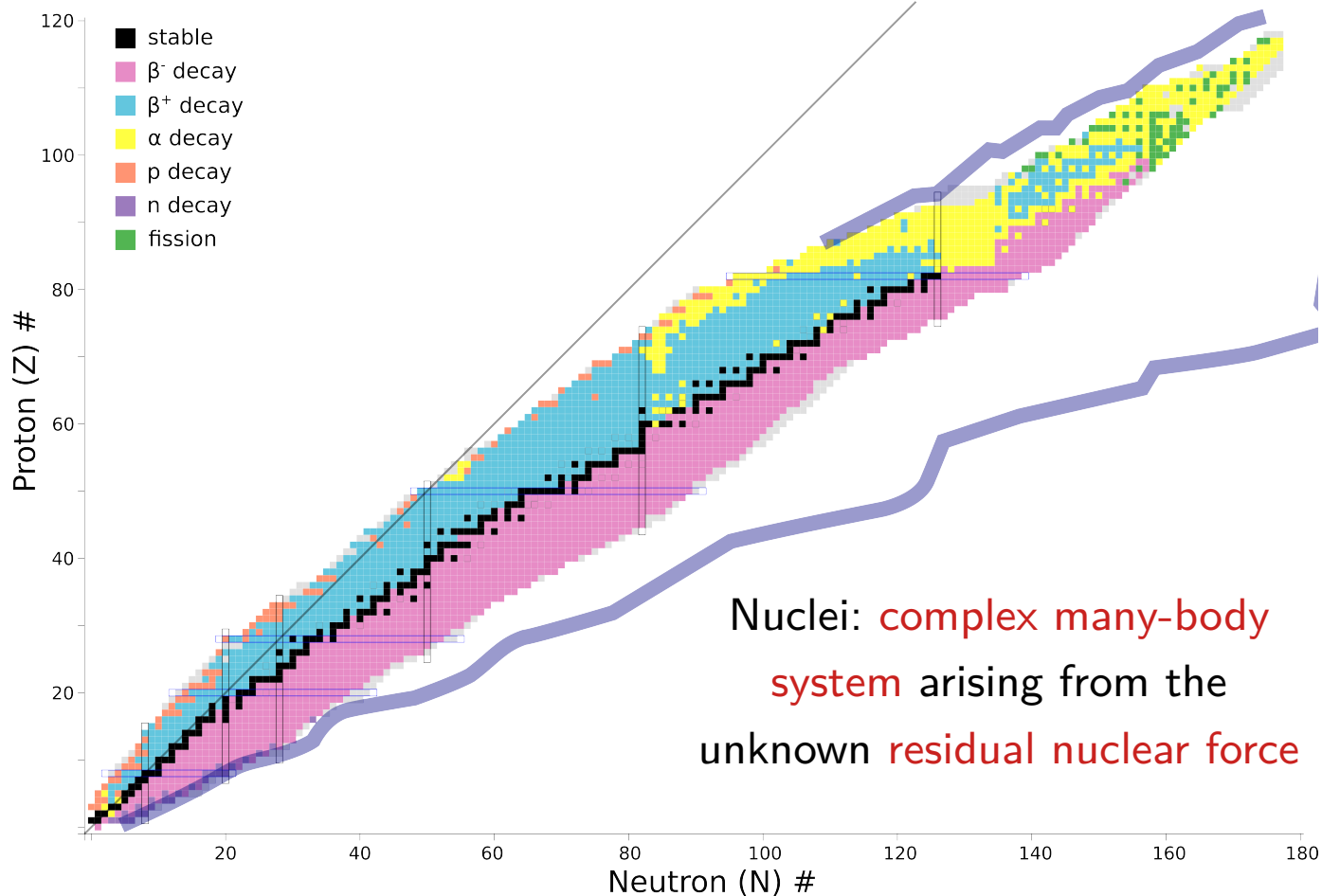

# The liquid drop model (1939)

Semi-empirical approach to describe binding energy  
→ understand fission

$$B(Z, A) = a_V A - a_S A^{2/3} - \frac{a_C Z^2}{A^{1/3}} - \frac{a_A (N - Z)^2}{A} + \delta$$

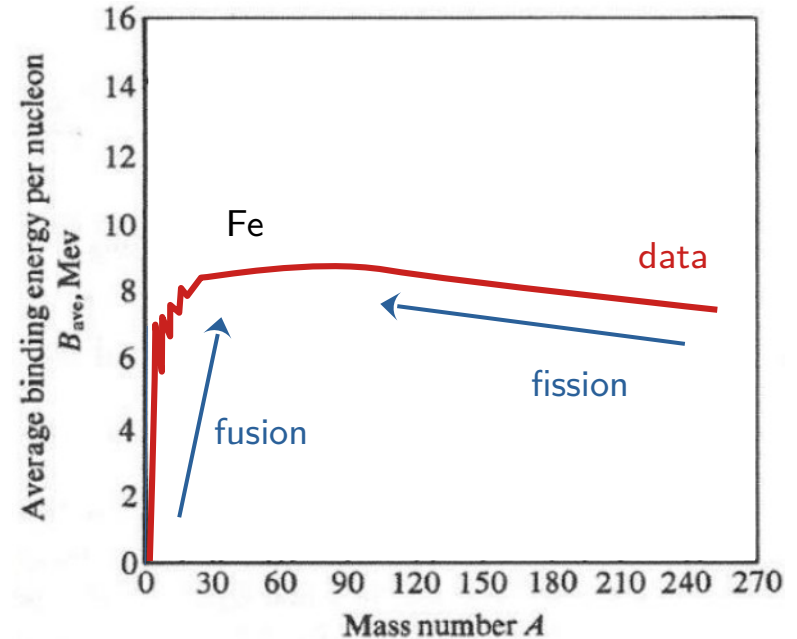
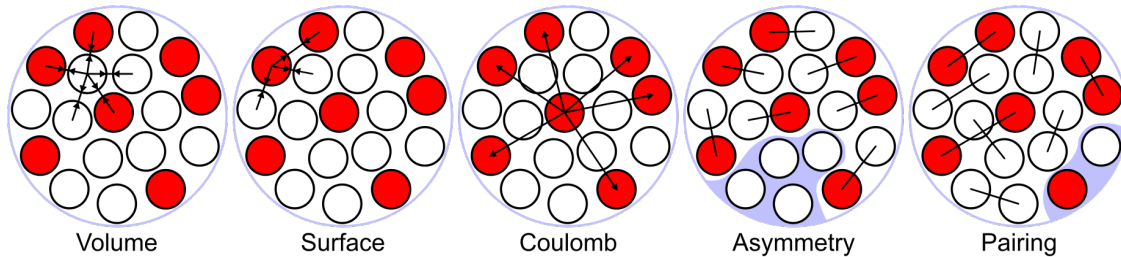

# The liquid drop model (1939)

Semi-empirical approach to describe binding energy  
→ understand fission

$$B(Z, A) = a_V A - a_S A^{2/3} - \frac{a_C Z^2}{A^{1/3}} - \frac{a_A (N - Z)^2}{A} + \delta$$

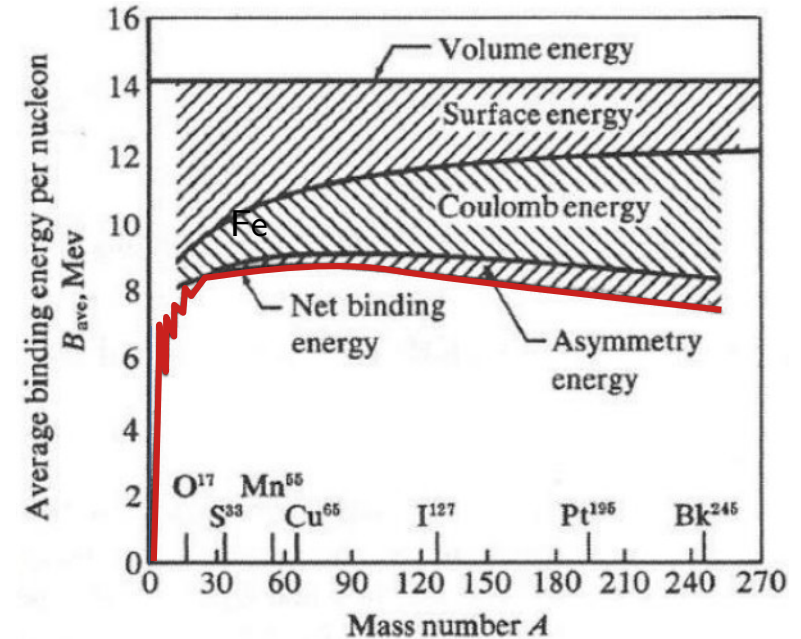
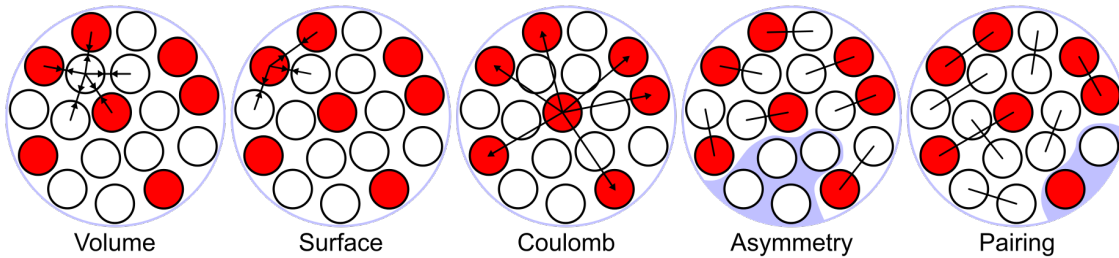

# The liquid drop model (1939)

Semi-empirical approach to describe binding energy  
→ understand fission

$$B(Z, A) = a_V A - a_S A^{2/3} - \frac{a_C Z^2}{A^{1/3}} - \frac{a_A (N - Z)^2}{A} + \delta$$

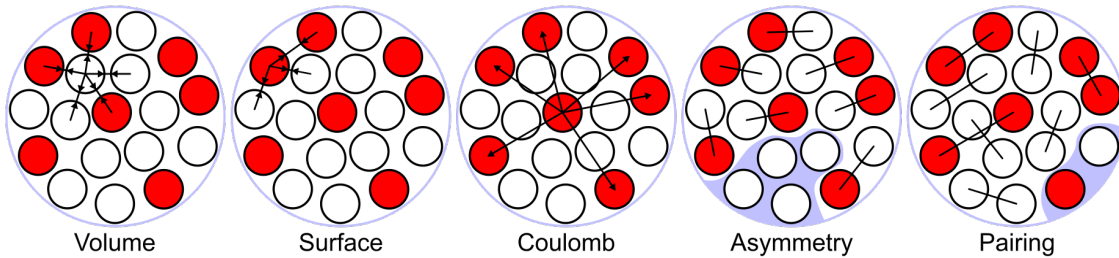

Deviation for **magic numbers** in protons/neutrons  
→ Evidence of a **shell structure**

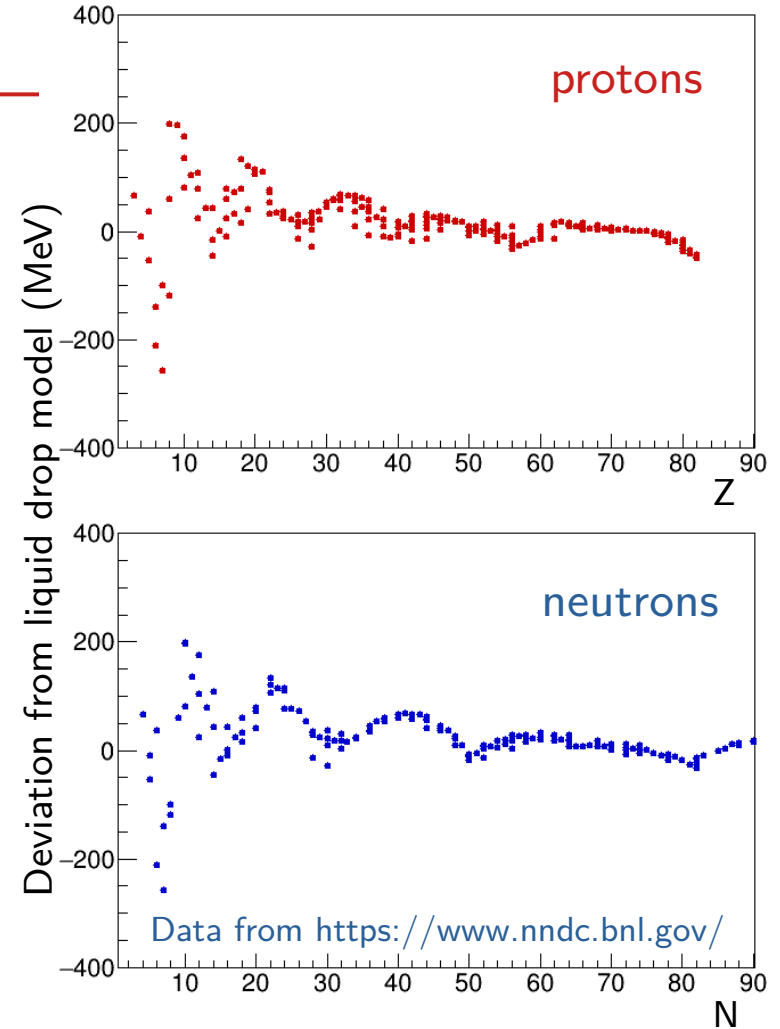

# The shell model (from 1949)

Magic numbers (2, 8, 20, 28, 50, 82, 126) → Evidence of a shell structure

- HO (or Wood-Saxons) + spin-orbit (SO) coupling  
→ reproduces magic numbers !

**Mayer and Jensen: Nobel Prize 1963**



2<sup>nd</sup> Nobel woman

- Successful for closed shells ~ spherical nuclei
- Outside closed shells (90% of the nuclei!) deformations, collective excitations

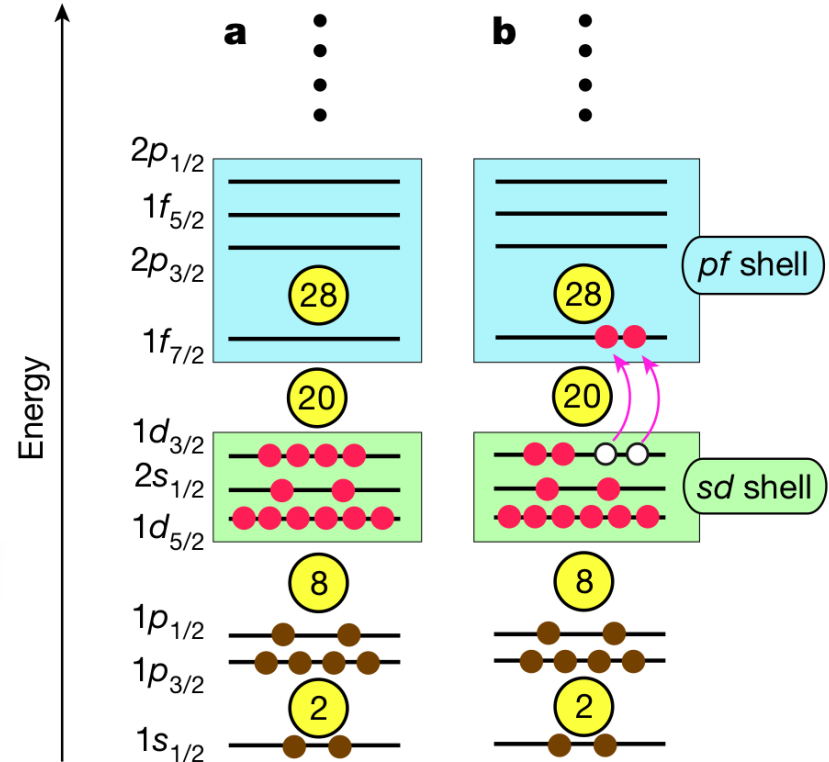
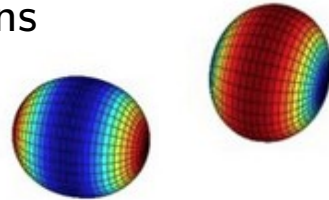
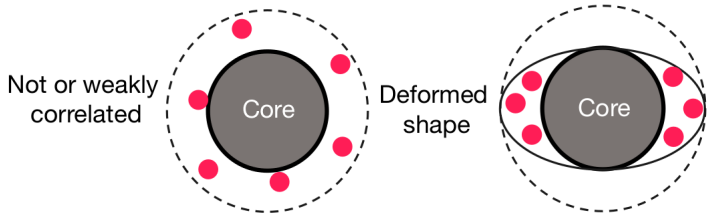

Tsunoda et al. Nature 587 (2020)

# The shell model (from 1949)

Magic numbers (2, 8, 20, 28, 50, 82, 126) → Evidence of a shell structure

- HO (or Wood-Saxons) + spin-orbit (SO) coupling  
→ reproduces magic numbers !

**Mayer and Jensen: Nobel Prize 1963**



2<sup>nd</sup> Nobel woman

- Successful for closed shells ~ spherical nuclei
- Outside closed shells (90% of the nuclei!) deformations, collective excitations

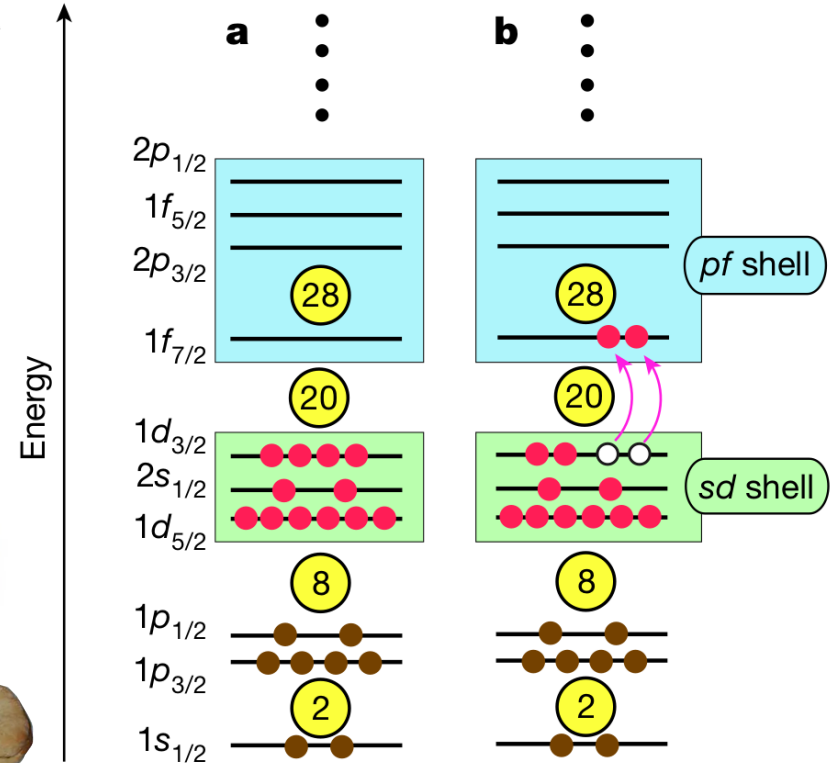
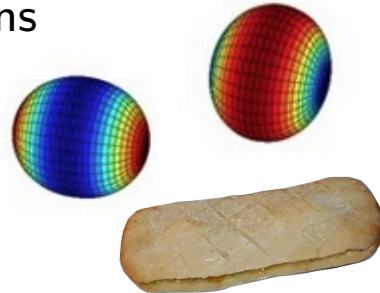
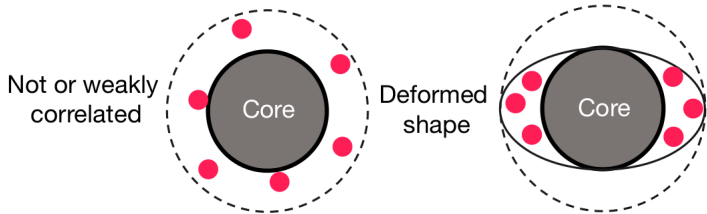

Tsunoda et al. Nature 587 (2020)

# Open questions

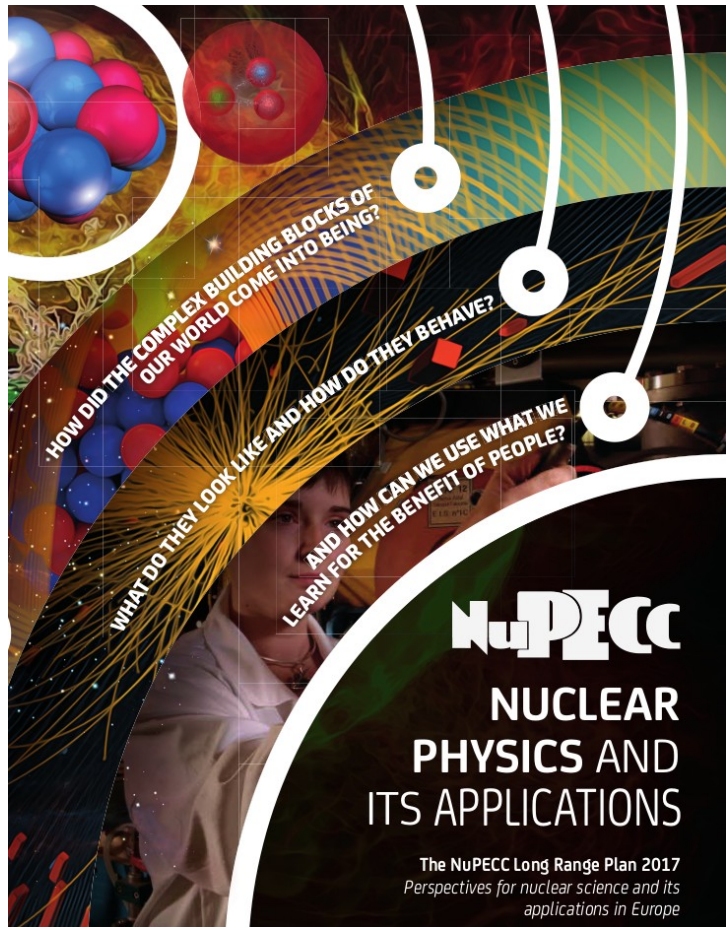

- How does the **complexity of nuclear structure** emerge from the interactions between the nucleons?  
*Nuclear structure and reactions*
- What are the **limits of nuclear stability** in terms of the numbers and proportions of protons and neutrons in a nucleus?  
*Exotic / super-heavy nuclei*
- How and where in the Universe are the **chemical elements produced**?  
*Nuclear astrophysics*
- What are the **benefits for society**?



# Facilities and instruments

CURRENT EUROPEAN  
NUCLEAR RESEARCH  
FACILITIES

- ★ **ISOLDE @CERN** → **HIE-ISOLDE**
  - ★ **GANIL** (*Grand Accélérateur National d'Ions Lourds*)  
Heavy-ion accelerator complex  
→ **SPIRAL2**: intense beams of rare isotopes
  - ★ **GSI**: light and heavy ions for exotic nuclei  
→ **FAIR** (*Facility of Antiproton Research*), **NUSTAR**
  - ★ **INFN Legnaro**: neutron-rich nuclei
  - ★ **JNR** (Dubna): dedicated for heavy-ion collisions for super heavy elements
- + **FRIB** (US) **RIKEN** (Japan)...

+ instruments (AGATA, EUCLID, PARIS...)

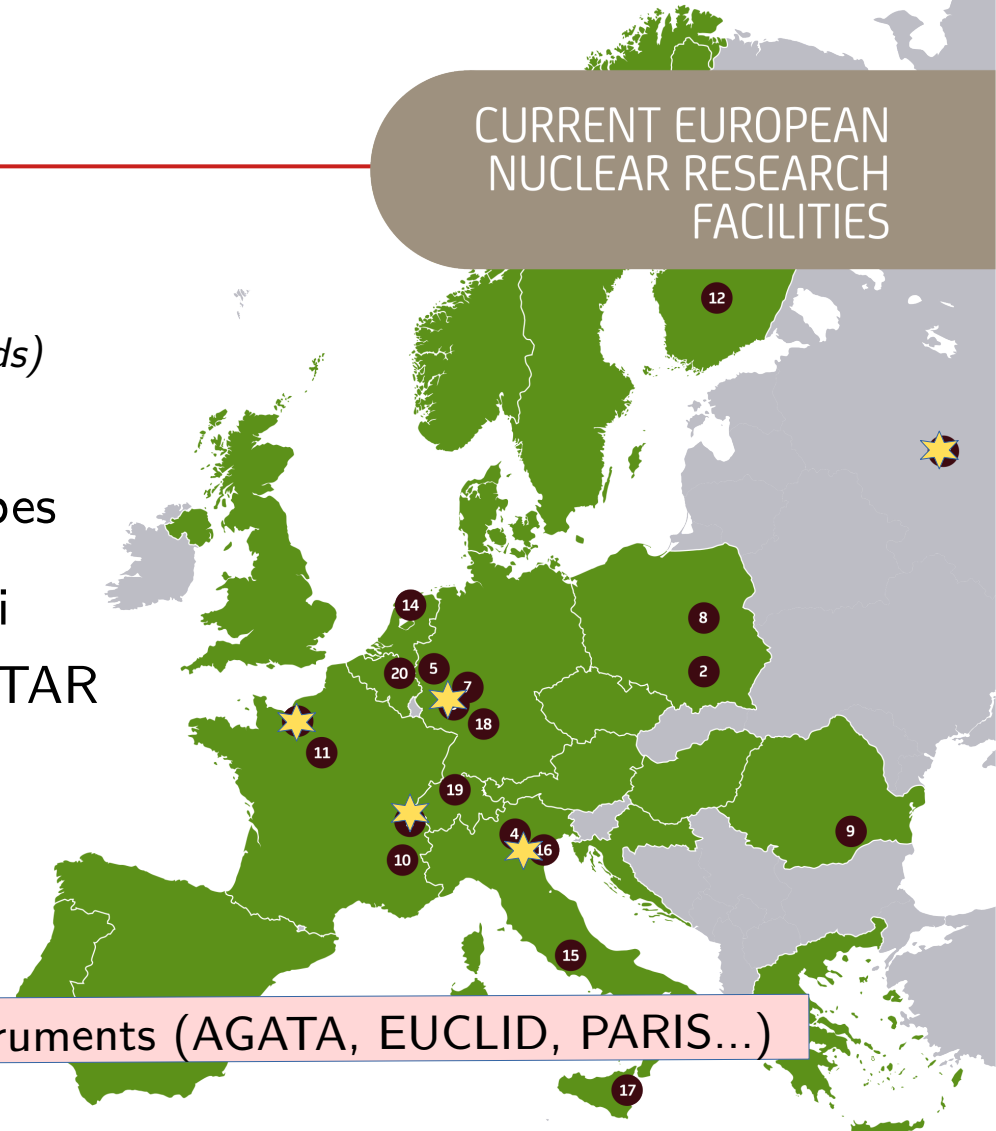

# Nuclear structure: selected topics

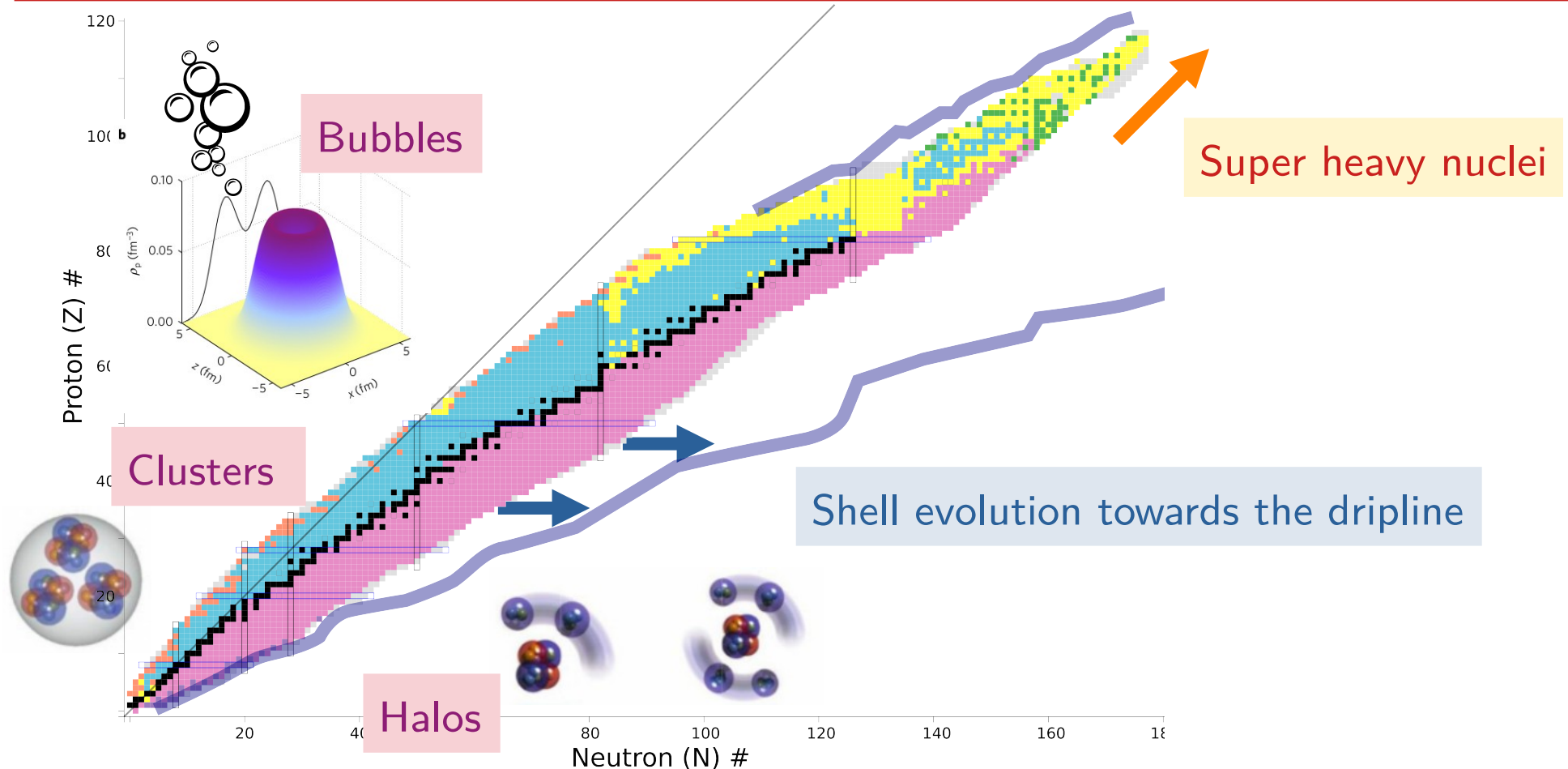

# Exploring the extremes: the neutron drip line

Energy of the first  $2^+$  excited state

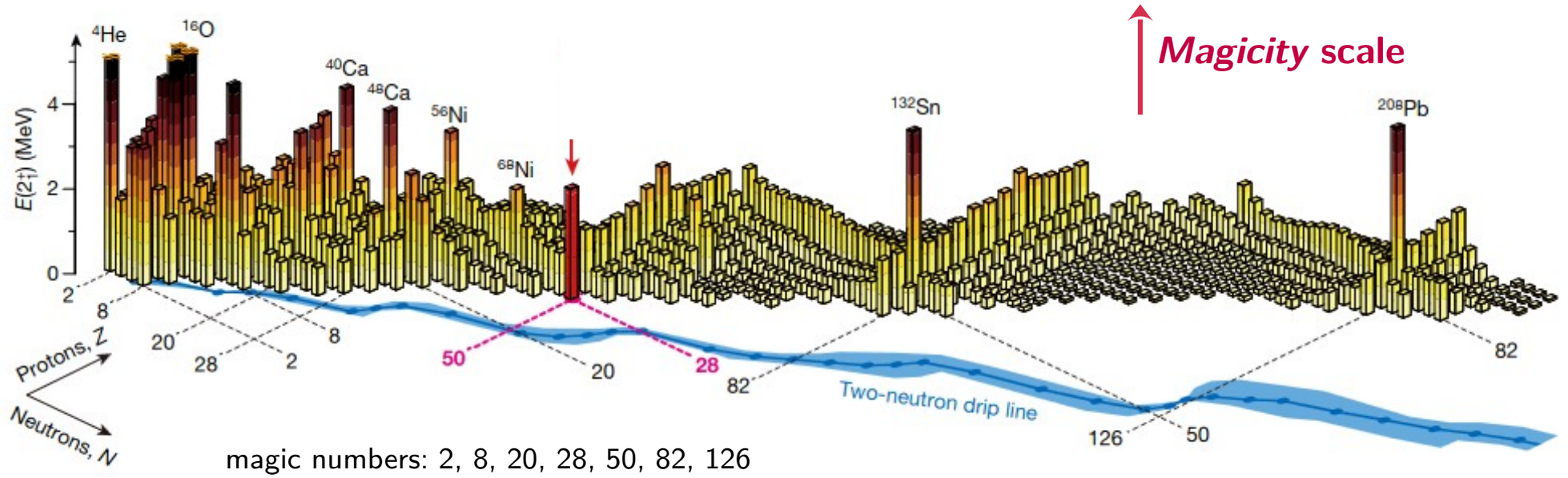

Taniuchi et al. Nature 569, 53–58 (2019)

# Exploring the extremes: the neutron drip line

Energy of the first 2+ excited state

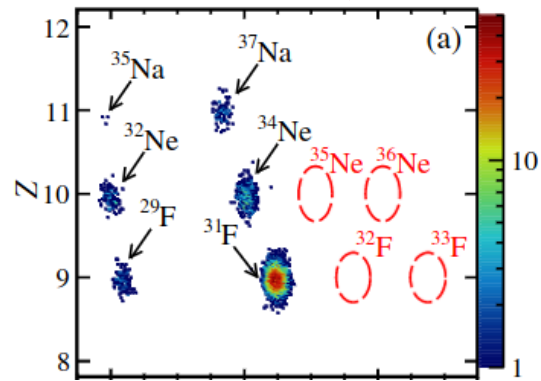
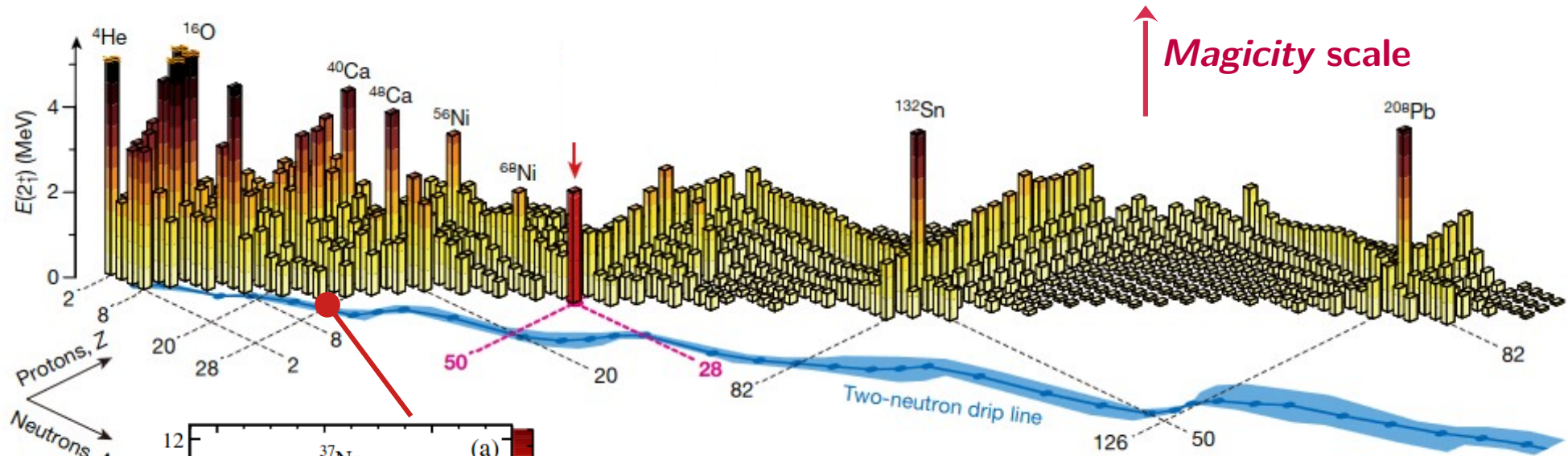

- Experimentally measured only until Ne ( $Z=10$ )  
*Ahn et al. Phys. Rev. Lett. 123 (2019)*

Taniuchi et al. Nature 569, 53–58 (2019)

# Exploring the extremes: the neutron drip line

Energy of the first  $2^+$  excited state

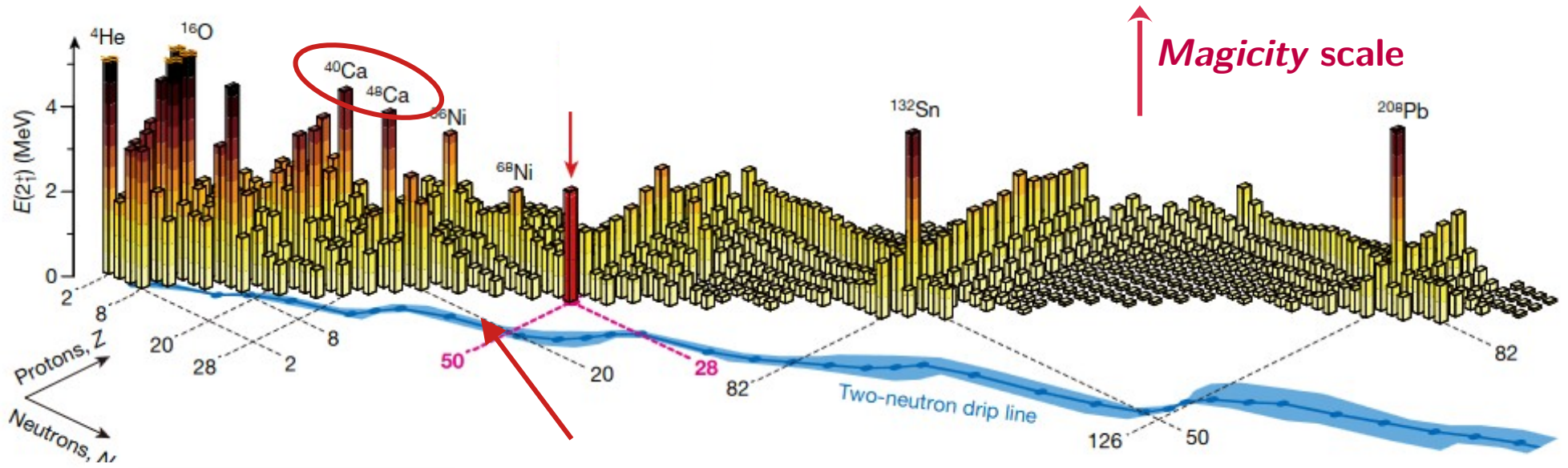

Taniuchi *et al.* Nature **569**, 53–58 (2019)

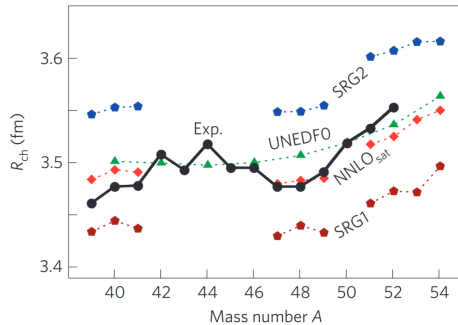

- Ca: exemplary case of shell evolution  
*Caurier et al. PRC 75 (2007)*
- New neutron magic numbers?  $N=32, 34$   
*Garcia-Ruiz et al. Nature Phys 12 (2016)*

# Exploring the extremes: the neutron drip line

Energy of the first  $2^+$  excited state

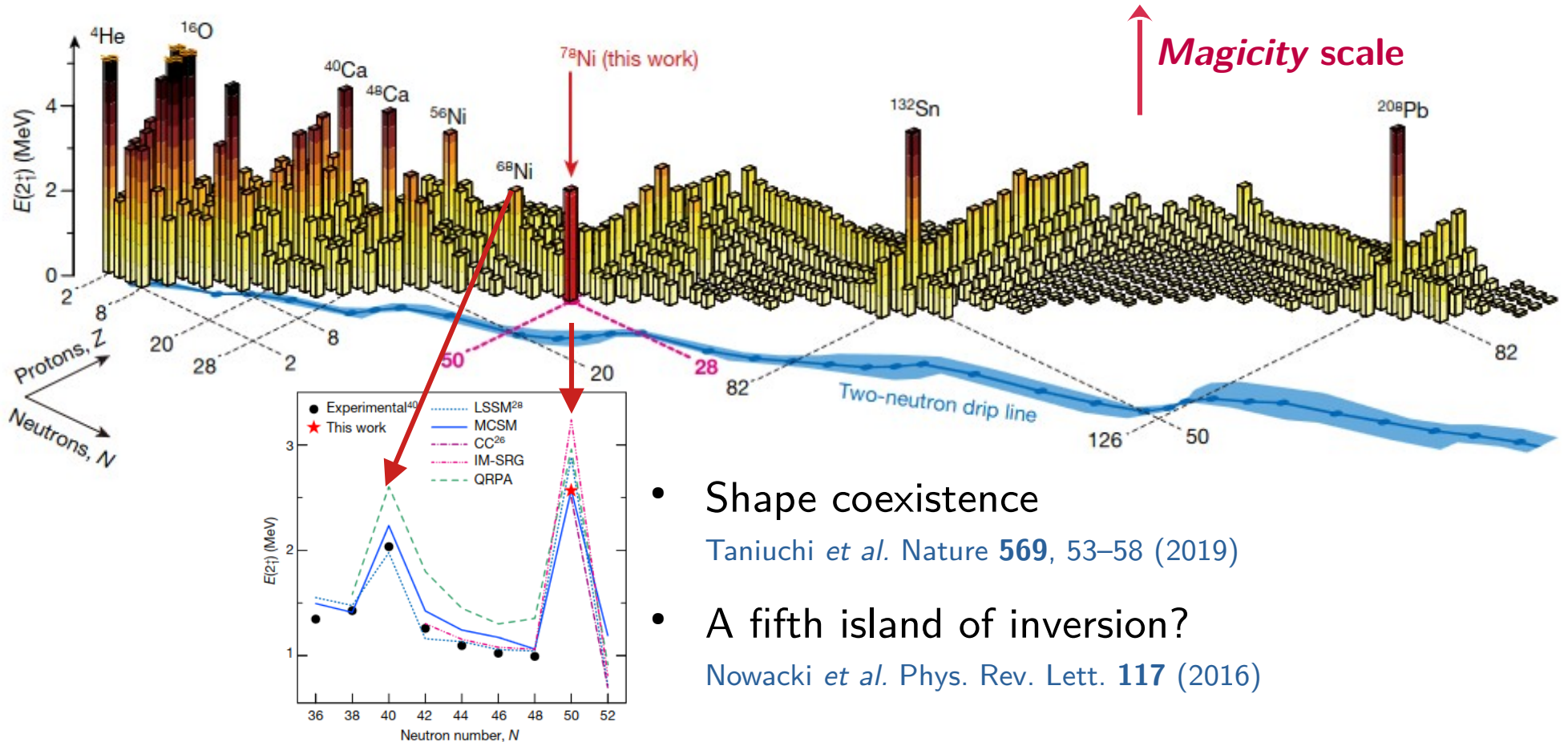

Taniuchi *et al.* Nature **569**, 53–58 (2019)

- Shape coexistence  
Taniuchi *et al.* Nature **569**, 53–58 (2019)
- A fifth island of inversion?  
Nowacki *et al.* Phys. Rev. Lett. **117** (2016)

# Exploring the extremes: super heavy nuclei

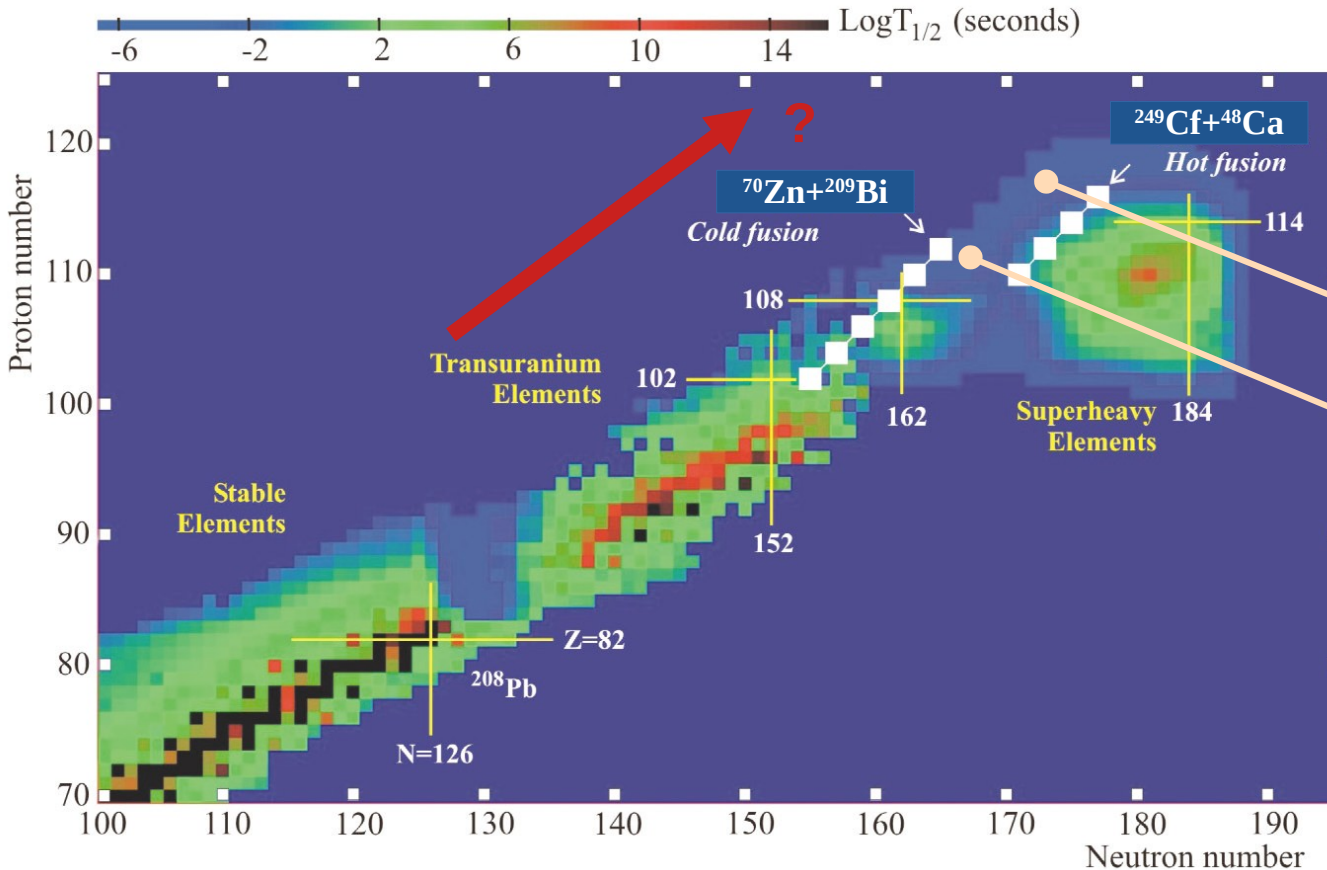

- What is the **heaviest element?**

2002, Dubna  
 $Z=118$  (Oganesson)

2003, RIKEN  
 $Z=113$  (Nihonium)  
3 atoms in 553 days...

Oganessian Pure Appl. Chem., **78**, 5 (2006)

# Exploring the extremes: super heavy nuclei

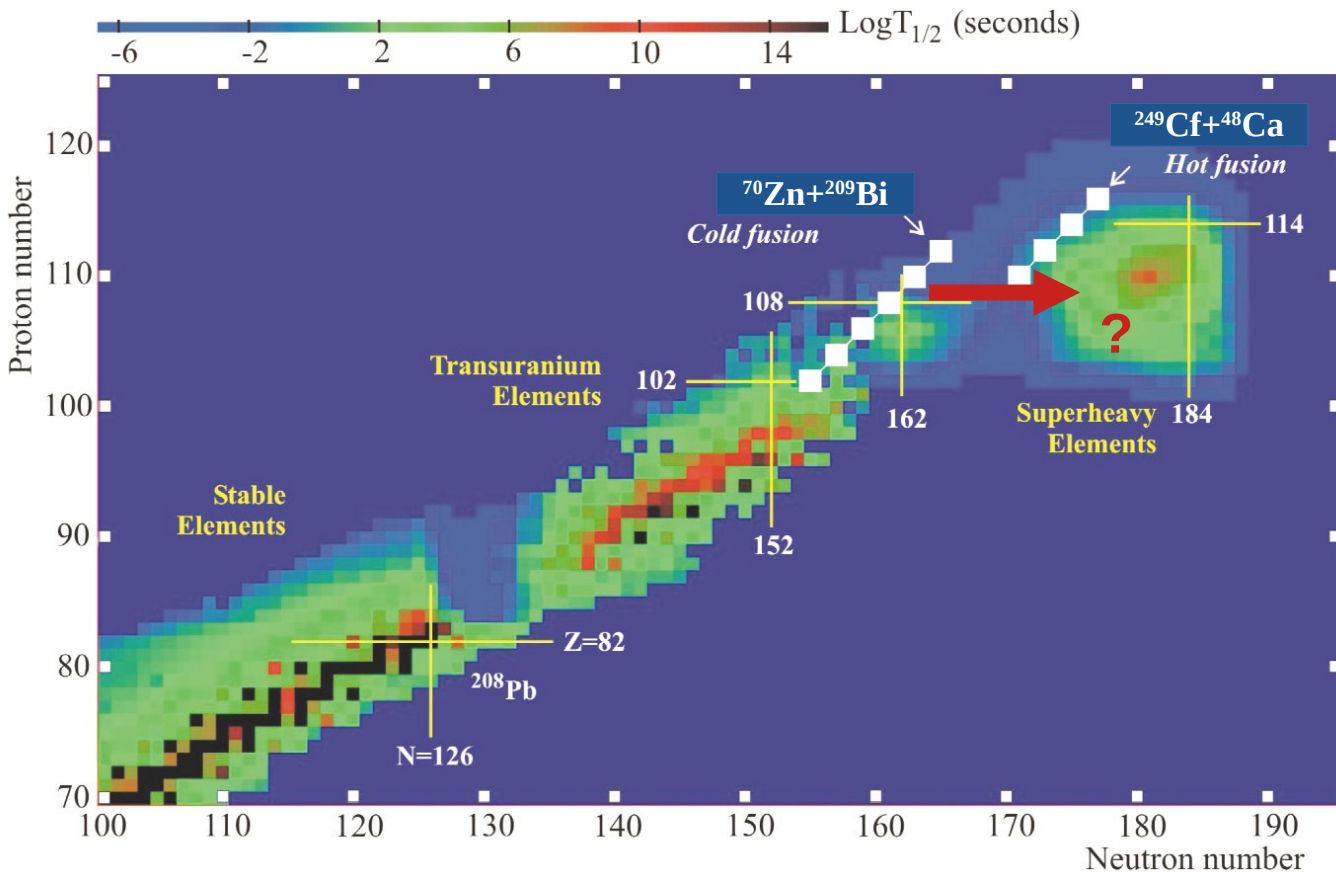

- What is the **heaviest element**?
- Is there an **island of stability** and where?

	Z	N
HFB	126	184
RMF	120	172
WS	114	184
FRLD	114	178

Oganessian Pure Appl. Chem., **78**, 5 (2006)



# Reaction dynamics : modern fusion studies

- Fusion hindrance :  
cross-sections falling off faster as expected: **repulsive core?**

Mișicu and Esbensen,  
PRL **96** (2006)

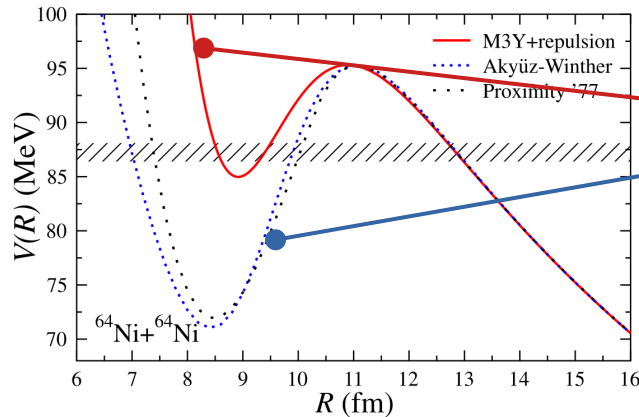

Jiang *et al.* Phys. Rev. Lett. **93** (2004)

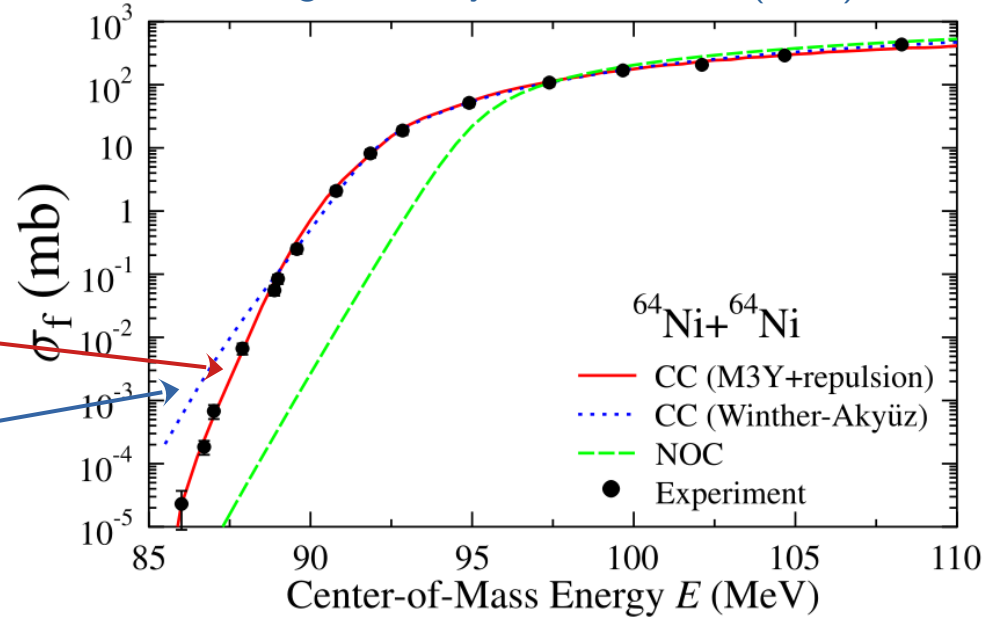

Pauli repulsion! Simenel *et al.*, PRC **95** (2017)

# Reaction dynamics : modern fission studies

- Mechanism of spin generation of fission fragments?

Wilson *et al.* Nature **590** (2021)

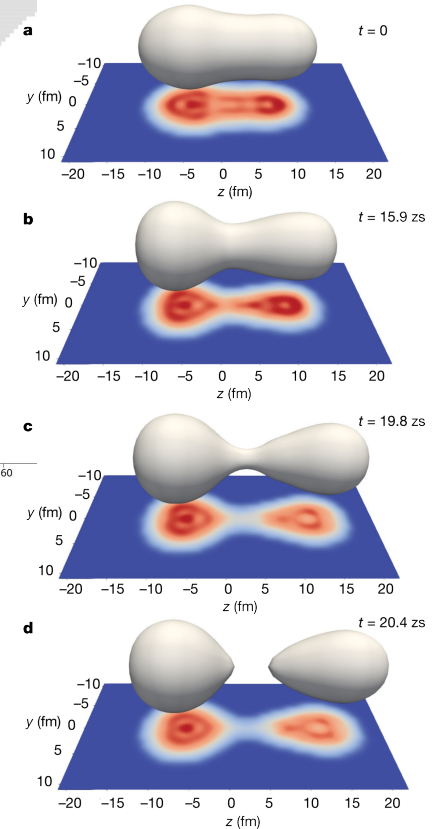
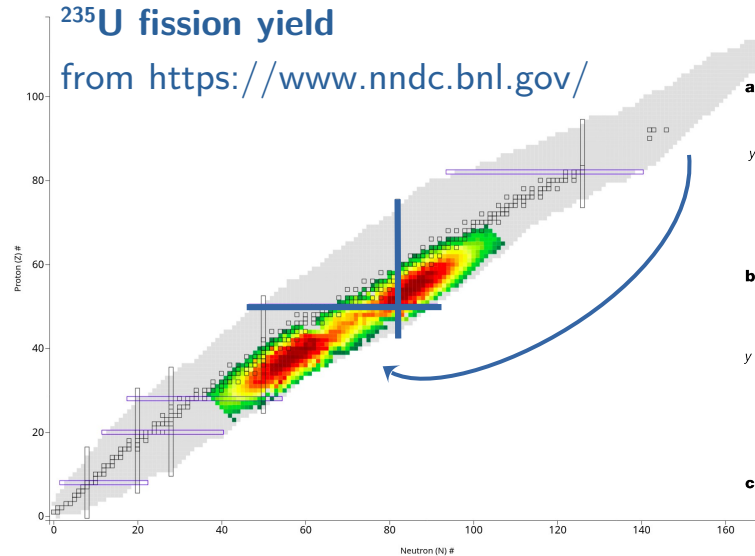
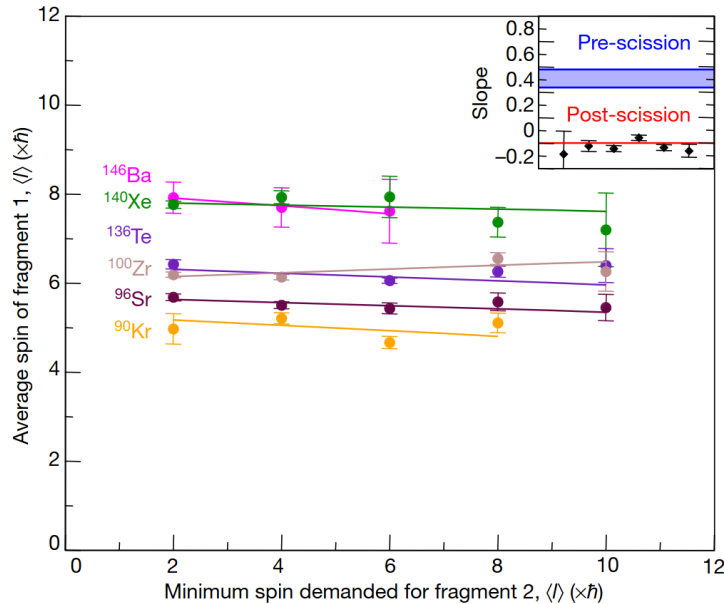

- Towards a microscopic description?

Scamps and Simenel Nature **564** (2018)

# Nuclear astrophysics

Understand **chemical abundance** evolution and  
astrophysical **production sites**

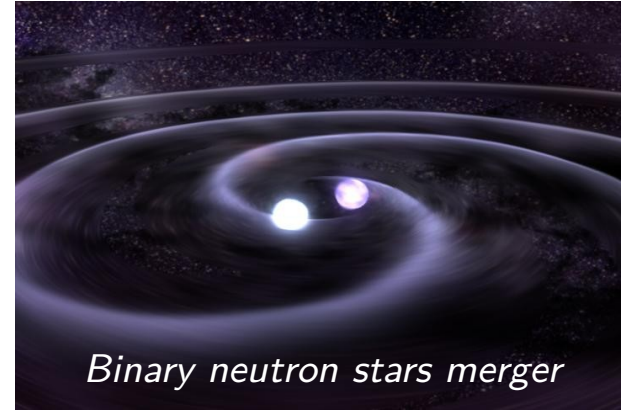

Reifarth\_ejc2014.sciencesconf.org

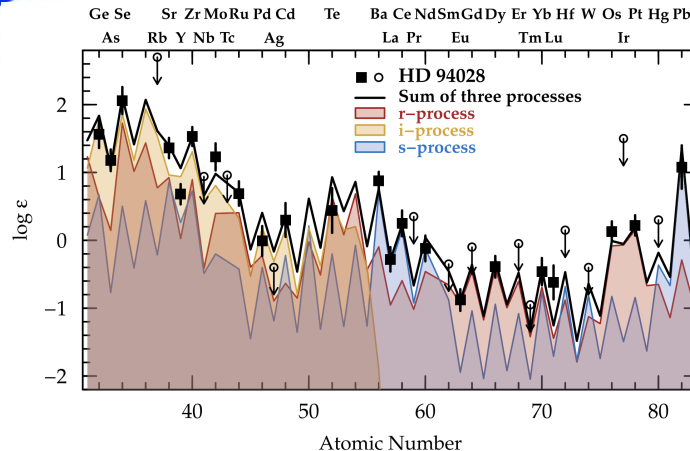
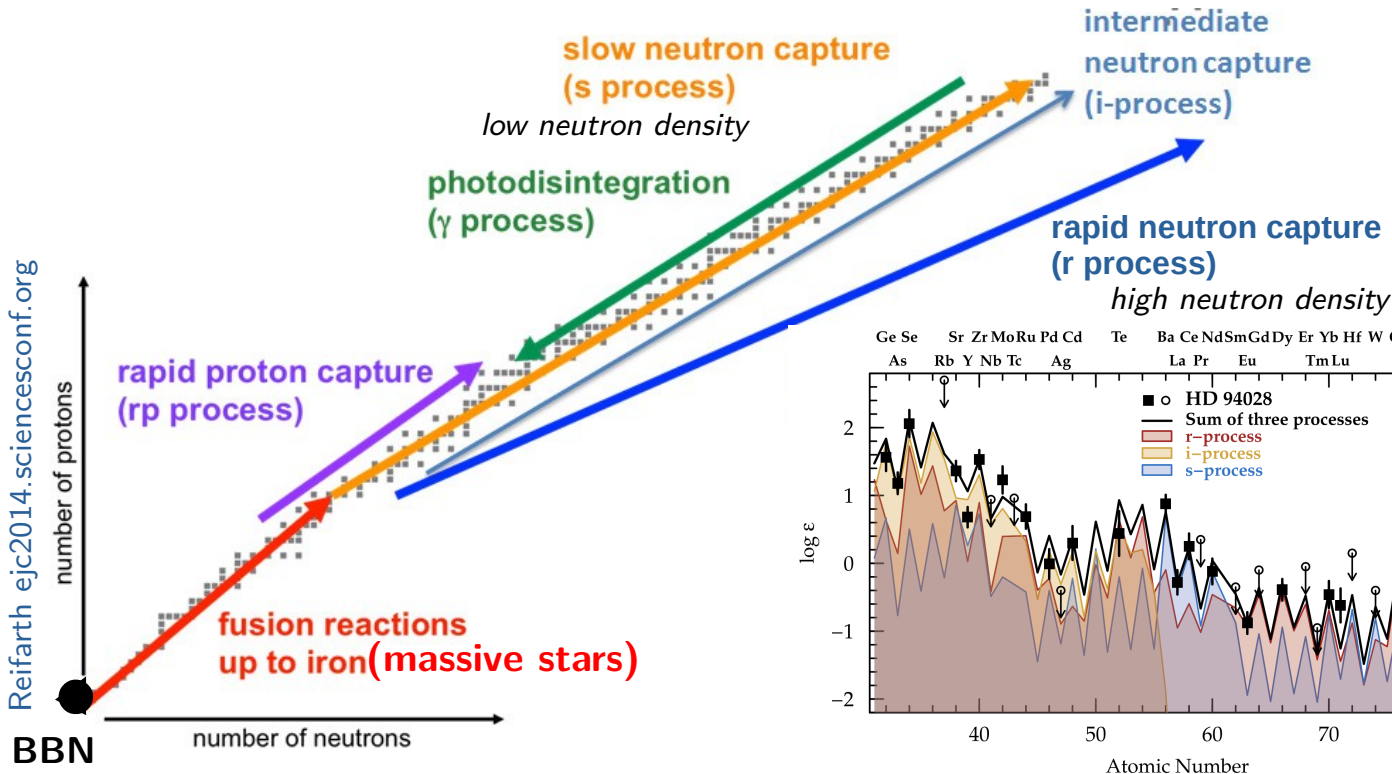

arXiv:2205.07996

# Nuclear astrophysics

Nuclear reaction rates governs **energy production**,  
**creation of elements**  $r = N_x N_y \langle \sigma v \rangle (1 + \delta_{xy})$

**nuclear physics!** 

Available energy = **thermal energy (kT)**  
→ depends on astrophysical scenario!

- **Neutron captures:**  $E \sim$  **thermal energy (kT)**
  - Nuclear reactions between **charged particles:**  
**thermal energy (kT)** vs. **Coulomb barrier:** TUNNELLING  
→ Relevant energy = **Gamow windows**  
Ex:  $T_{\text{sun}} \sim 15 \cdot 10^6 \text{K}$ ,  $kT \sim 1 \text{keV}$   $E_C = 500 \text{keV}$  →  $E_G = 5.9 \text{keV}$
1. Quiescent burning (fusion in stars) →  $\sigma \sim$  (pbarn-nbarn)
  2. Explosive burning → unstable species!

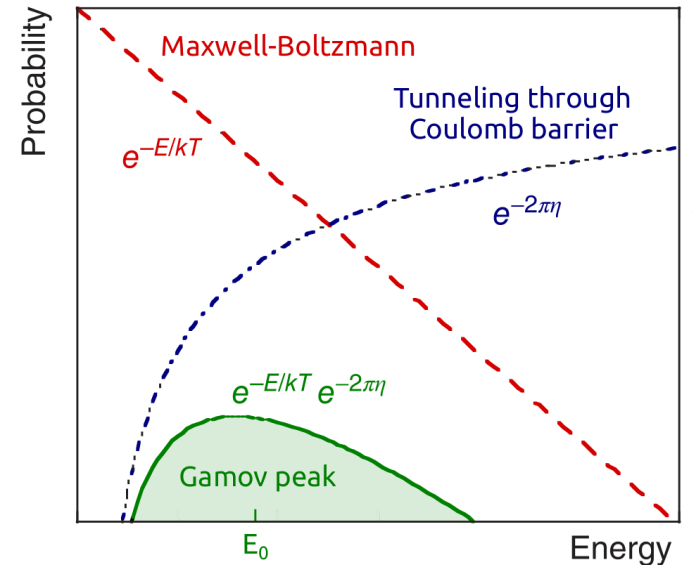

# Quiescent stellar burning

- The special case of  $^{12}\text{C} + ^{12}\text{C}$



Hubert  
Reeves  
PhD  
(1960)

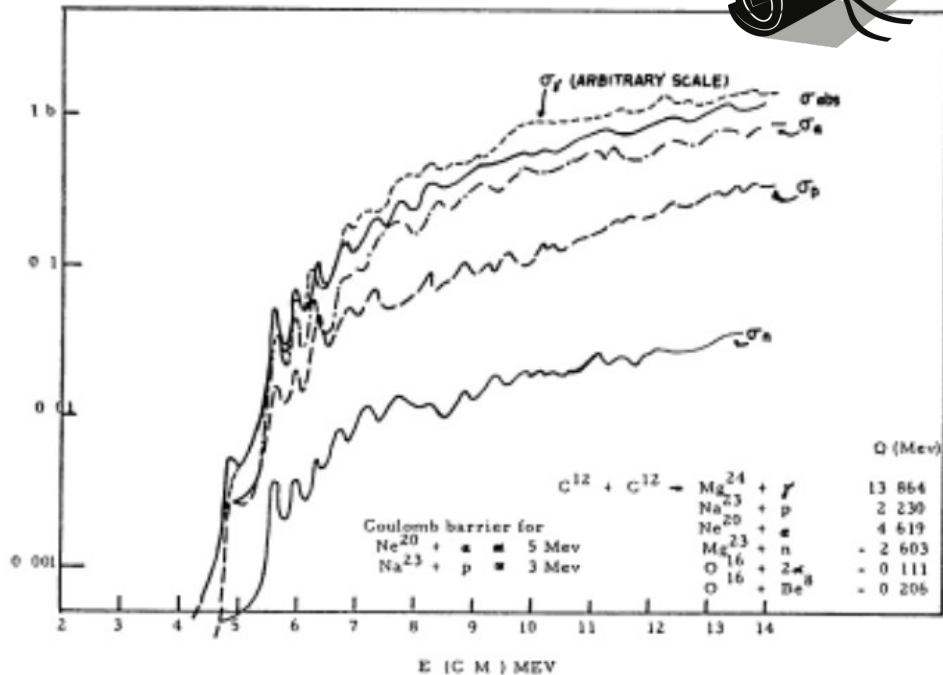

FIG. 1.—Experimental cross-sections for the  $\text{C}^{12} + \text{C}^{12}$  reactions

## CARBON, OXYGEN, AND NEON THERMONUCLEAR REACTION RATES

HUBERT REEVES\*

Département de Physique, Université de Montréal, Montréal, P.Q.

Received October 7, 1961; revised November 20, 1961

### ABSTRACT

Recent experimental results obtained with the Chalk River Tandem accelerator are used to calculate the rate of thermonuclear reactions involving carbon, oxygen, and neon nuclei. The astrophysical relevance of these reactions and of the subsequent processes is discussed briefly.

### I. INTRODUCTION

Extensive measurements of the nuclear reactions between  $\text{C}^{12}$ ,  $\text{N}^{14}$ , and  $\text{O}^{16}$  and heavier nuclei have recently been carried out with the Chalk River Tandem accelerator (Almqvist, Bromley, and Kuehner 1960; Bromley, Kuehner, and Almqvist 1960). Although an analysis of the properties of these reactions appears to be complicated, it might still be possible to extract from the data at least some crude estimates of certain thermonuclear reaction rates which are of importance for the understanding of stellar evolution. Such reactions are expected to provide the energy sources for the stars in the red giant branches. It is expected, for instance, that, following the helium-burning stage, the stellar core, composed mainly of carbon and oxygen, will contract until it reaches temperatures that are high enough to guarantee the nuclear reaction rate corresponding to the radiation output of the star. In this paper we want to compute the thermonuclear rate of energy generation from isotopes of carbon, oxygen, and neon.

Several papers have been written on the carbon and oxygen thermonuclear reactions, prior to the advent of the Chalk River results (Hayashi *et al.* 1958; Cameron 1959a). Rather indirect methods had then been used to evaluate the rates. In one of these papers (Reeves and Salpeter 1959) an upper and a lower limit to the rates of  $\text{C}^{12} + \text{C}^{12}$  had been evaluated, and the subsequent discussion had been extensive enough to encompass both the upper and lower limit. Since the present estimate falls in between these limits, a part of this discussion can be carried out, and will be summarized later in this paper.

### II. DATA

#### a) $\text{C}^{12} + \text{C}^{12}$

In Figure 1 are shown the cross-sections for the various outcomes of the  $\text{C}^{12} + \text{C}^{12}$  reaction. Although the relative accuracy between various neighboring points of these curves is excellent (the uncertainty is less than 10%), the absolute values and the relative accuracy are not so good. The data of Almqvist (1960) represent the yield of neutrons (due to the thresholds of the counters) at  $42^\circ$  and  $27^\circ$ , and of neutrons of all energies at  $30^\circ$ . The  $\alpha$  and  $p$  missed because of the bias on the total number of  $\alpha$  and  $p$  emitted is an  $\alpha$  first states in  $\text{Ne}^{20}$  could always be detected, at these levels and the next higher levels, the  $\alpha$  is more probable. Alphas could also come from the  $\text{C}^{12} + \text{C}^{12}$  reaction at low  $\text{C}^{12}$  energy ca. 10 Mev, as will be discussed in a later paragraph.

\* During a stay at Theoretical Physics, A.E.C.L.,

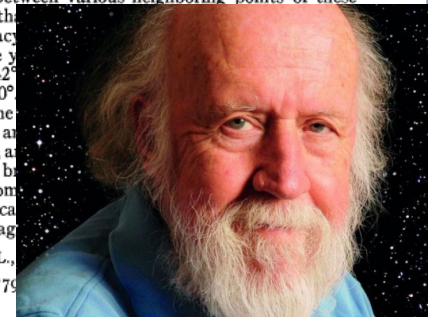

# Quiescent stellar burning

- The special case of  $^{12}\text{C} + ^{12}\text{C}$

Fruet *et al.* PRL **124** (2020)

Hint of a low energy resonance?

Fusion hindrance?

Relevant range for massive stars

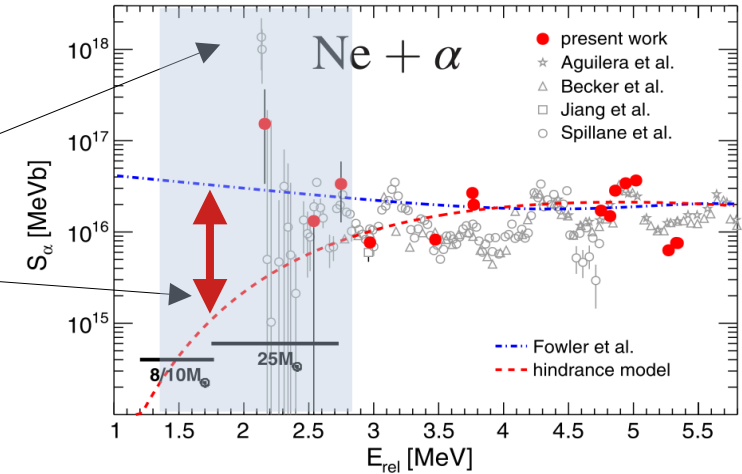

# Quiescent stellar burning

- The special case of  $^{12}\text{C} + ^{12}\text{C}$

Fruet *et al.* PRL **124** (2020)

Hint of a low energy resonance?

Fusion hindrance?

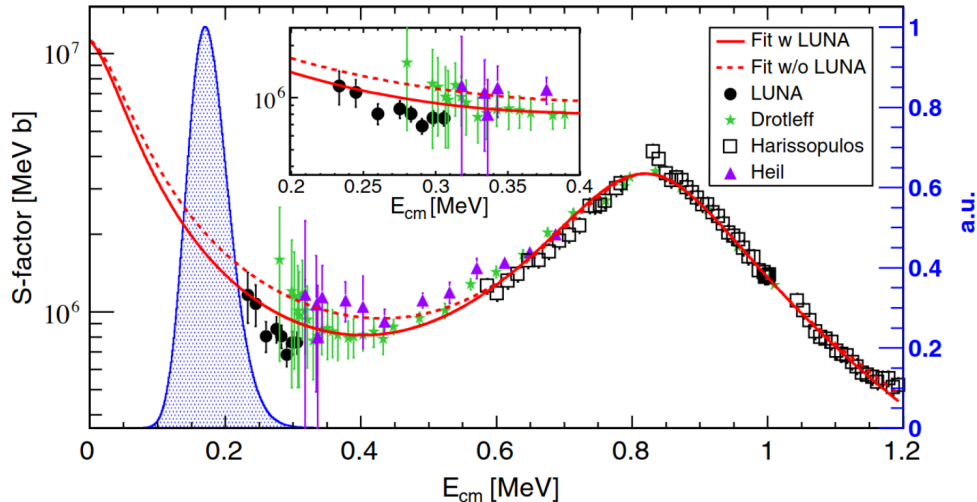

Relevant range for massive stars

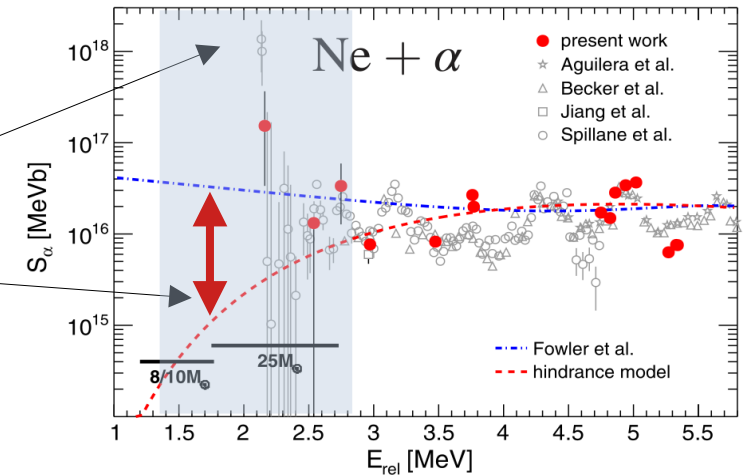

- A main neutron source for the s-process:  
 $^{13}\text{C}(\alpha, n)^{16}\text{O}$  Ciani *et al.* Phys. Rev. Lett. **127** (2021)

Going **underground!** LUNA

# Explosive burning

- Kilonova associated with GW170817: EM transient ( $\sim 1-10$  days)
- Identification of strontium: support of r-process *Watson et al. Nature 574 (2019)*
- Complex modelling

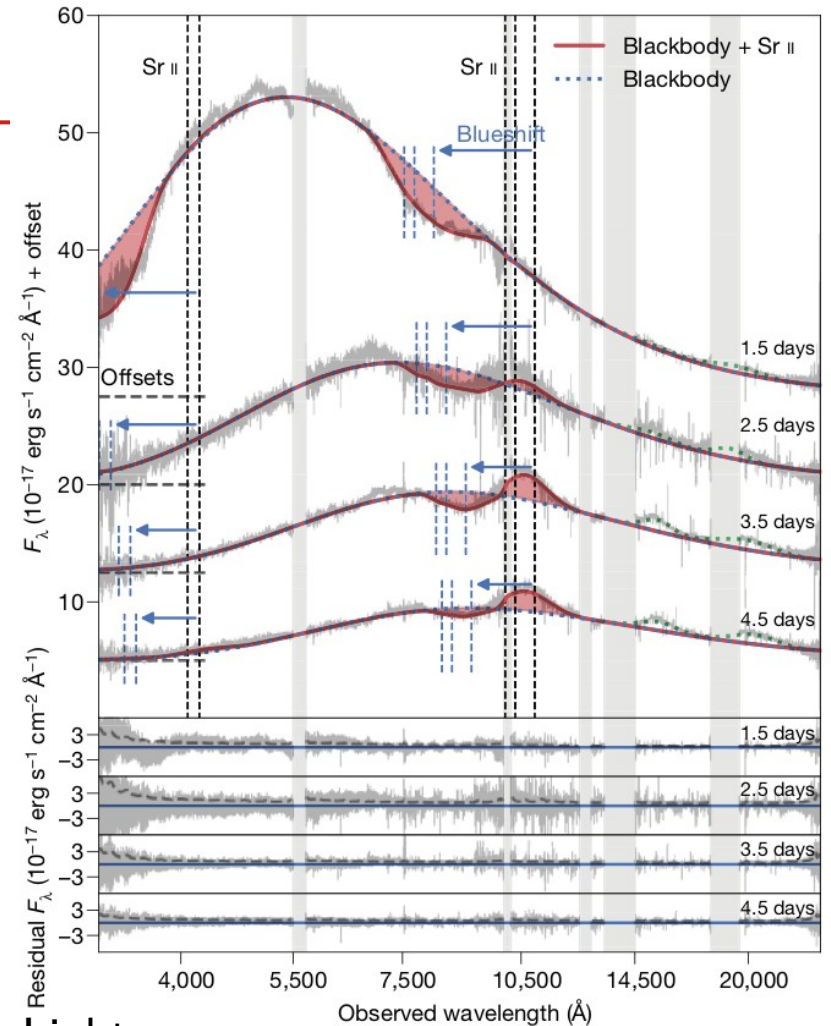
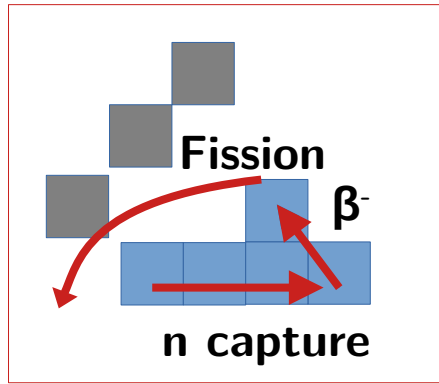
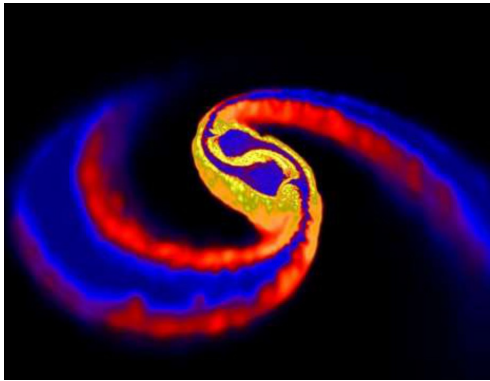

Astrophysical simulations  $\longleftrightarrow$  Nucleosynthesis  $\longleftrightarrow$  Light curves



# On the relevance of nuclear databases...

- Low energy neutron physics



JEFF-33  
ENDF/B-VIII  
JENDL  
...

- Improved data for medicine, nuclear technology...

JANIS Web <https://www.oecd-nea.org/janisweb/>

Comparison of (p,n) and (n,gamma) reactions for ADS decommissioning  
Jonathan COLLIN

- Reactor **antineutrino** flux prediction



arXiv:2304.14992 (2022)

Estienne *et al.* Phys. Rev. Lett. **123** (2019)

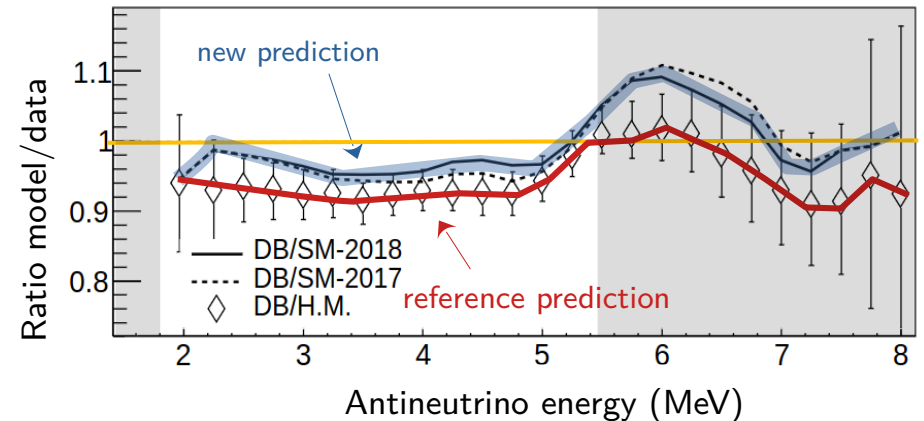

# The end!

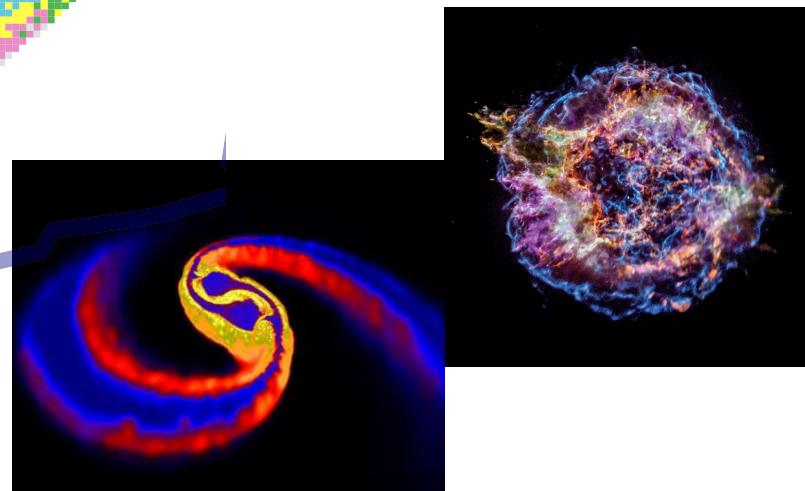
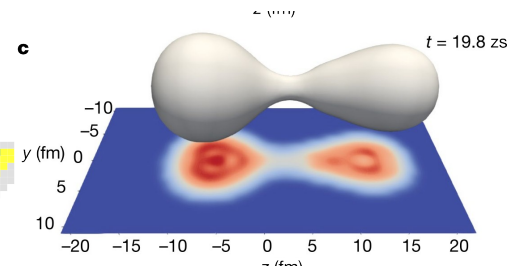
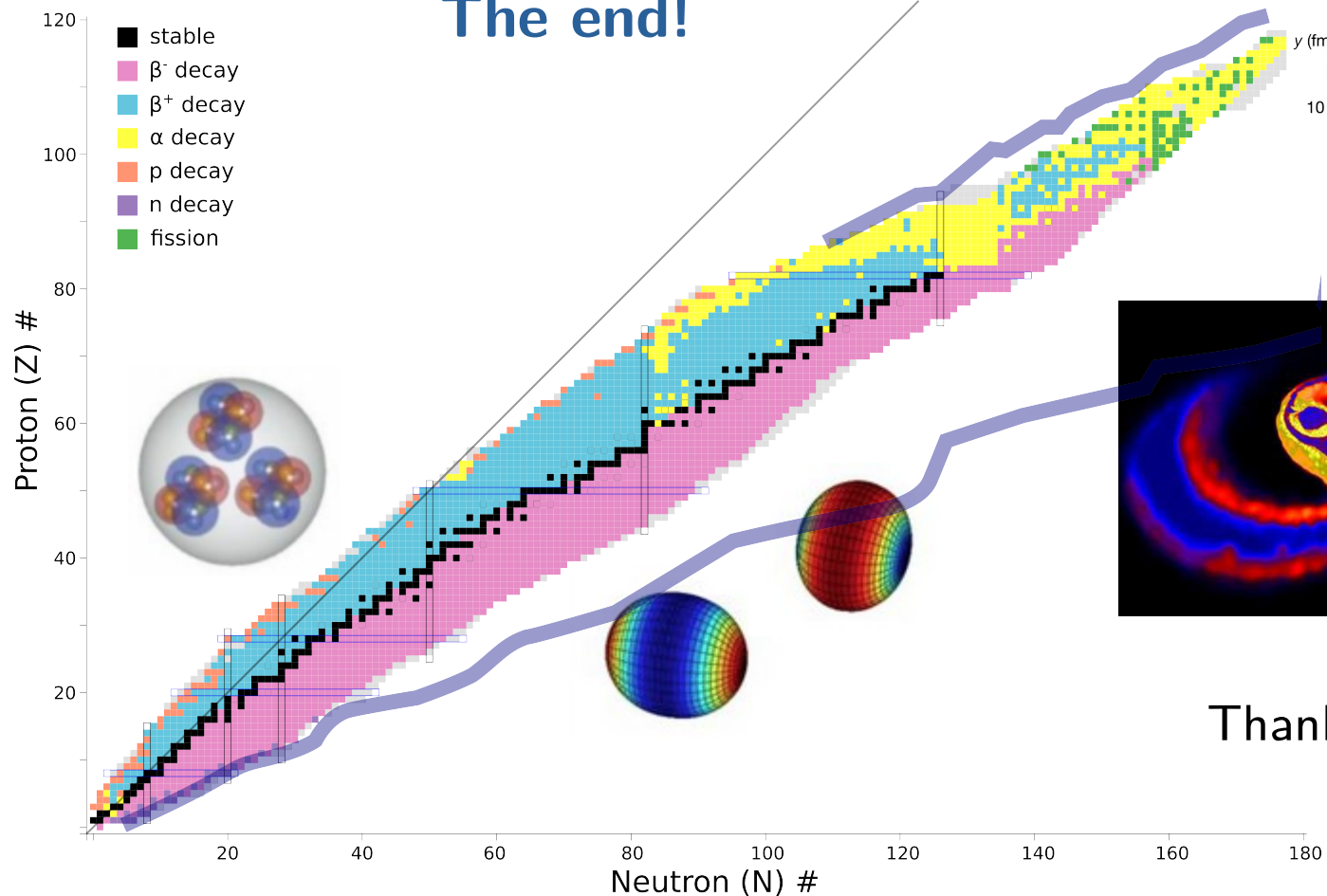

Thanks for your attention!

# Complexity of nuclear structures

- Central density depletion : “bubble” observed in  $^{34}\text{Si}$  by proton removal  
Mutschler *et al.* *Nature Phys* **13**, 152–156 (2017)
- Z/N dependency test of the SO potential

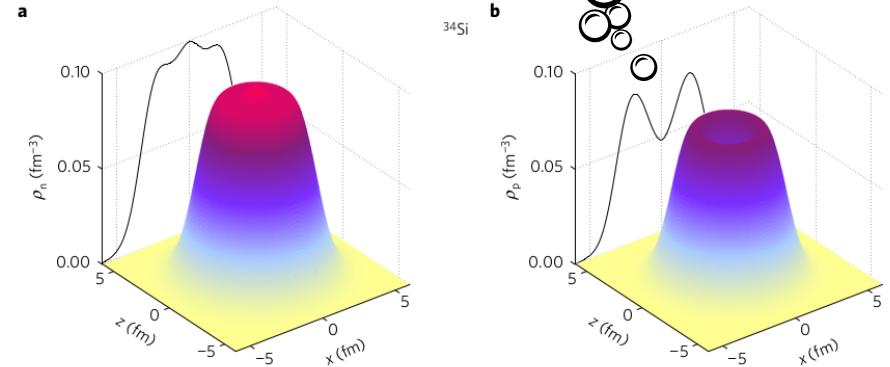

Ebran *Phys. Rev. C* **90** (2014)

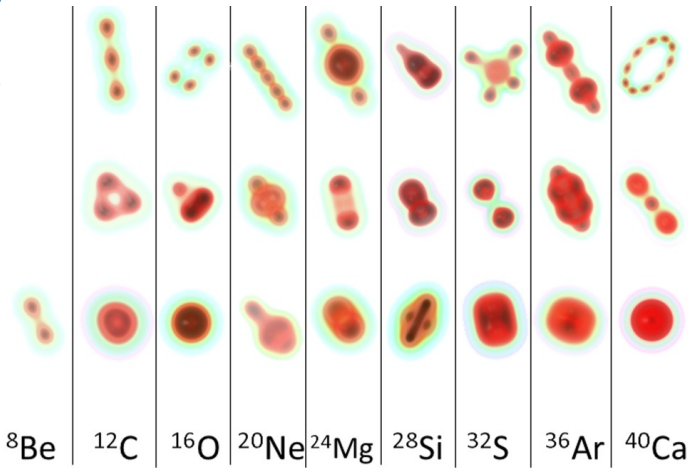

- Nuclear clustering : Ikeda  
Ikeda *et al.* *Prog. Theo. Phys. Suppl.* **E68** (1968)
- Theoretical predictions now from first principles  
Ebran *et al.* *Nature* **487**, 341–344 (2012)

*The triple alpha*  
 $^{12}\text{C}$  Hoyle state

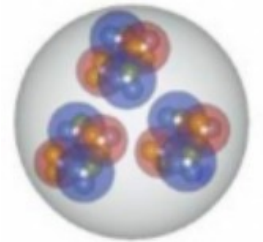

# Exploring the extremes: the neutron drip line

Energy of the first 2+ excited state

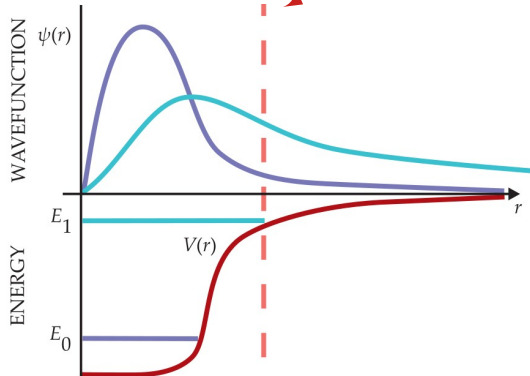
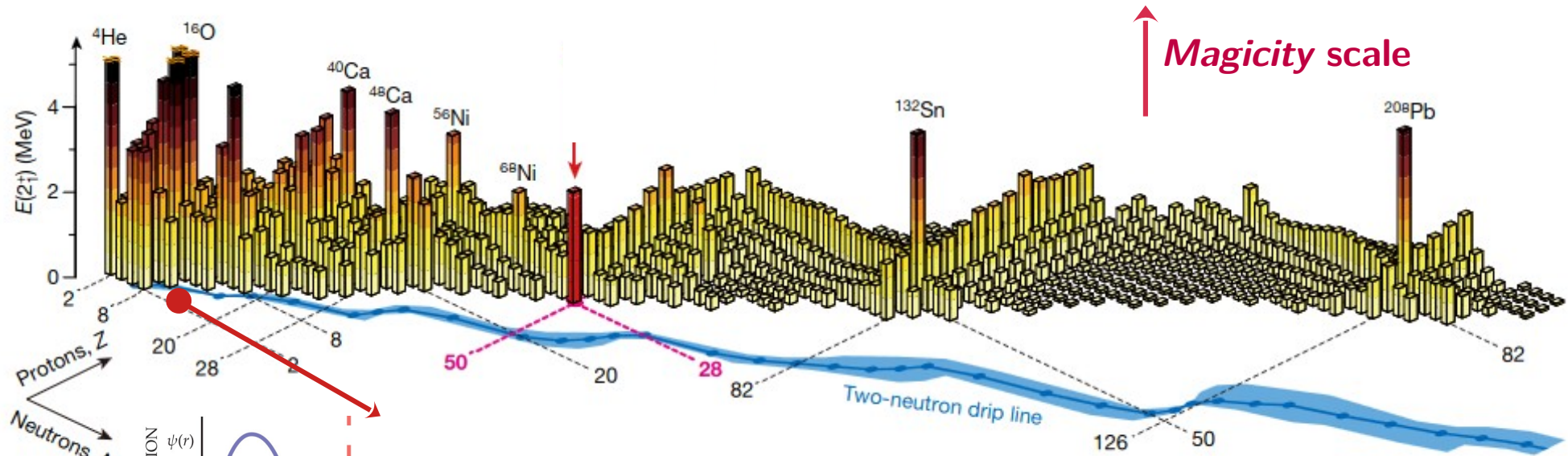

- Exotic structures : halos, neutron skins

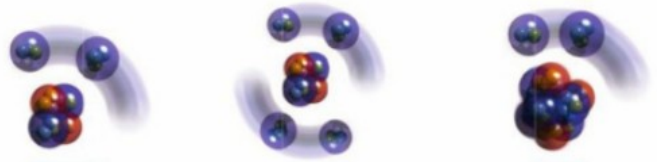

Taniuchi et al. Nature 569, 53–58 (2019)

# The shell model

Bohr and Mottelson (1998)

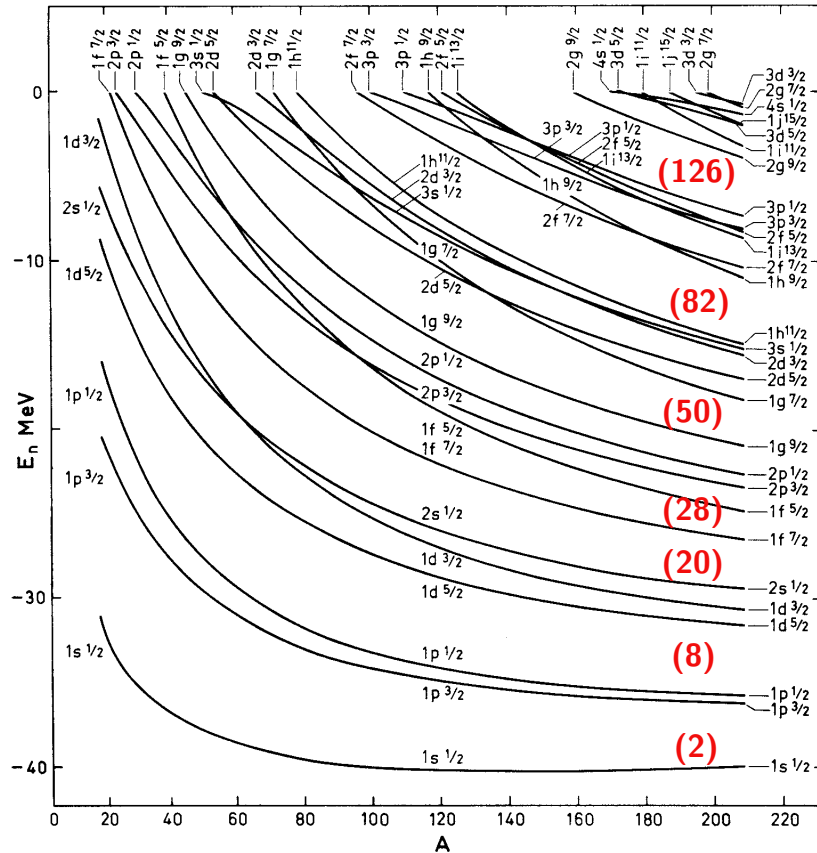

$$H = H_0 + H_1 \longrightarrow \text{residual interaction}$$

easy to solve

Evolution of the shell structure

- Single particle excitations
- Collective excitations

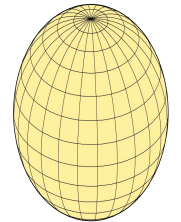
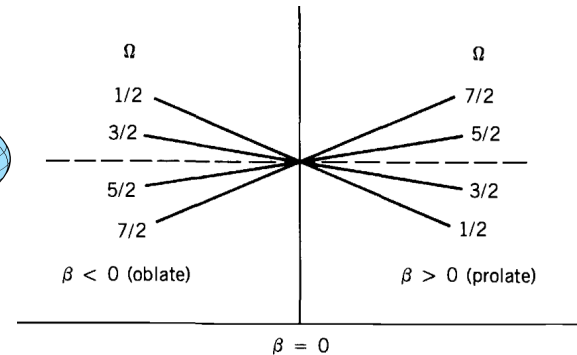
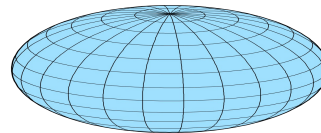
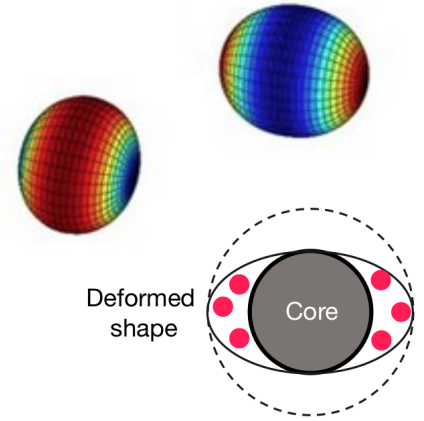

# GANIL Facility

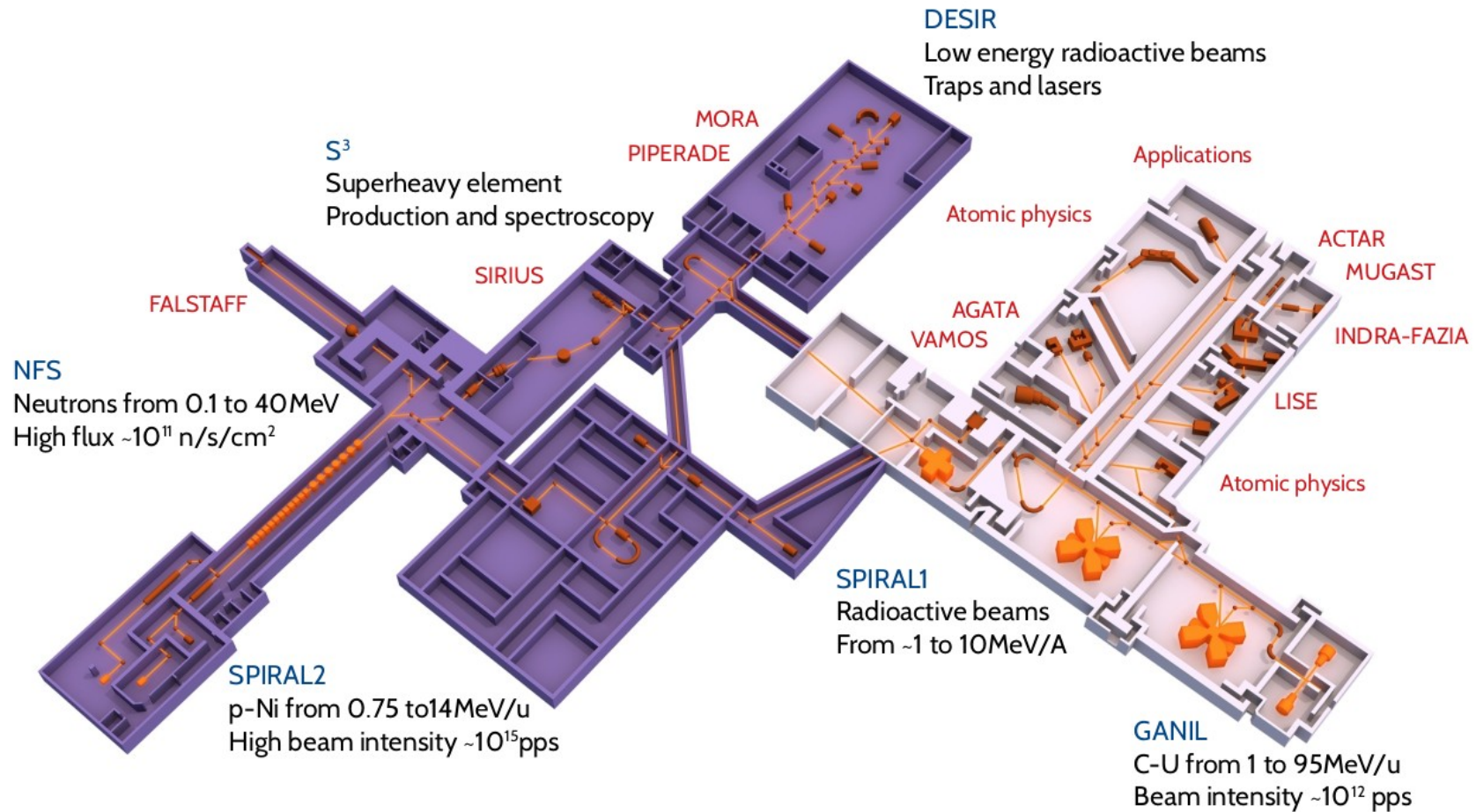

From Diego Gruyer, JRJC2021