



Les contributions envisagées pour de nouvelles jouvences pour LHCb à haute luminosité

Renaud Le Gac (CPPM)
pour la communauté LHCb France

Conseil scientifique IN2P3 – Amphithéâtre Charpak, Jussieu -- 6 février 2023

The three phases of the LHCb Experiment

	Date	Runs	Instantaneous \mathcal{L} [$\text{cm}^{-2} \text{s}^{-1}$]	Integrated \mathcal{L} [fb^{-1}]	pp Interaction per crossing
LHCb	2010 – 2018	Run 1 & 2	4×10^{32}	9	1
LHCb Upgrade I	2022 – 2032	Run 3 & 4	2×10^{33}	60 – 70	6
LHCb Upgrade II	2035 –	Run 5 & au delà	1.5×10^{34}	325	Up to 50

In this talk, we will concentrate on the interests of the LHCb France community for the LHCb Upgrade II

Plan

- ▶ Community LHCb-France
- ▶ Scientific project
- ▶ Interests in Calorimetry (ECAL Upgrade II)
- ▶ Interests in Trajectory (UT Upgrade II)
- ▶ Interests in DAQ and Real Time Analysis
- ▶ Milestones, staff and budget
- ▶ Laboratory's Scientific Councils
- ▶ Conclusions

Community LHCb-France

LHCb France

- ▶ We joined the LHCb Collaboration at the beginning in 1997. On average, we are 105 people from 6 institutes.

The % of authors is 6.7% in 2023 (41 / 608)

CPPM	
IJCLab	
LAPP	
LLR	≥ 2015 (Heavy Ion)
LPC	
LPNHE	
CC IN2P3	

- ▶ Associated institutes:
 - LPNHE → Universidad Nacional de Colombia, Bogota
- ▶ Technical associates:
 - IJCLab → Taras Shevchenko National University of Kyiv, Ukraine
 - LLR → Département de Physique Nucléaire (DPhN), IRFU

Evolution of the population

- ▶ The population of physicists is relatively stable over 10 years:

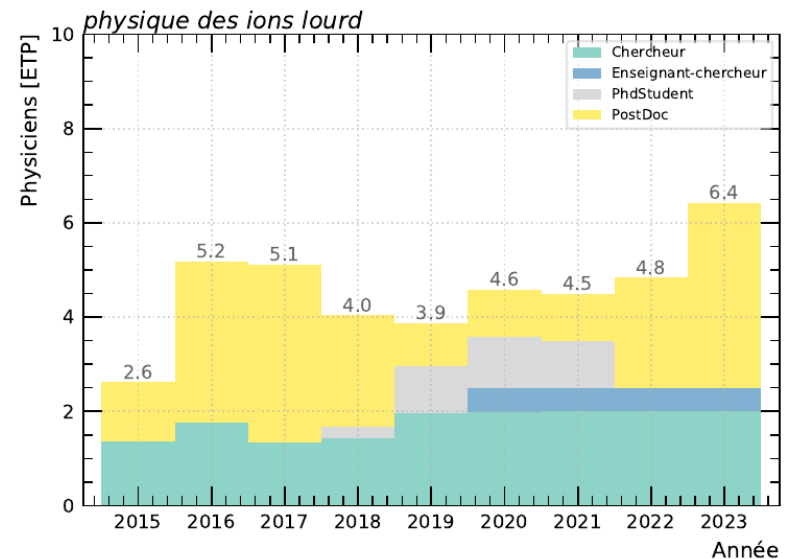
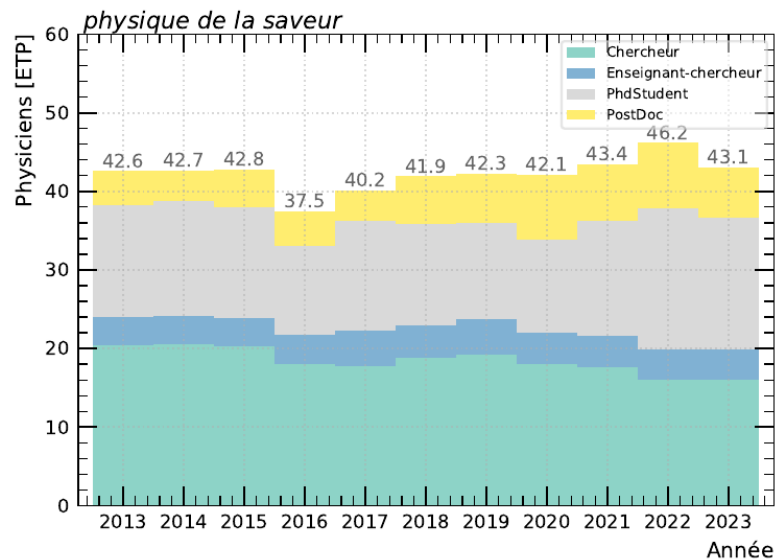

- ▶ The LHCb Upgrade II project attracts newcomers from the ALICE collaboration:
 - SUBATECH, 4 physicists with expertise in the ALICE / MFT detector
 - LPC, 3 physicists have expressed their interest in joining LHCb by LS3
 - IRFU, 3 physicists with expertise in the ALICE / MFT detector. Interested by the R&D of LV CMOS sensors for UT Upgrade II

Scientific project

Main goals

- ▶ The primary goals of the LHCb collaboration is to reveal physics beyond the Standard Model by studying CP violation and rare, semileptonic decays in the beauty and charm sectors.
- ▶ With time, goals extended to physics in the forward direction ($2 < \eta < 5$):
 - Electroweak physics
 - Heavy Ion physics
 - Fixed target program (pNe, pHe, pAr, PbNe, ...)
 - Spectroscopy of exotic states
 - ...

Methodologies

- ▶ The main method is to measure precisely observables and to look for deviations with respect to accurate predictions of Standard Model, in particular:
 - Heavily suppressed in the Standard Model
 - Involving loop amplitudes like box and penguin diagrams
- ▶ New-physics processes depend mainly on two parameters:
 - a coupling
 - a mass scale

Use the large number of observables and the very rich phenomenology of beauty and charm decays to resolve this puzzle and to understand the nature of the new physics

- ▶ This approach is also complementary to direct searches since it can probe new physics beyond the mass scale directly accessible to the LHC

Publications with IN2P3 contributions

- ▶ It is a paper, submitted, signed by the LHCb collaboration for which at least one member of the LHCb-France community has signed the analysis note.

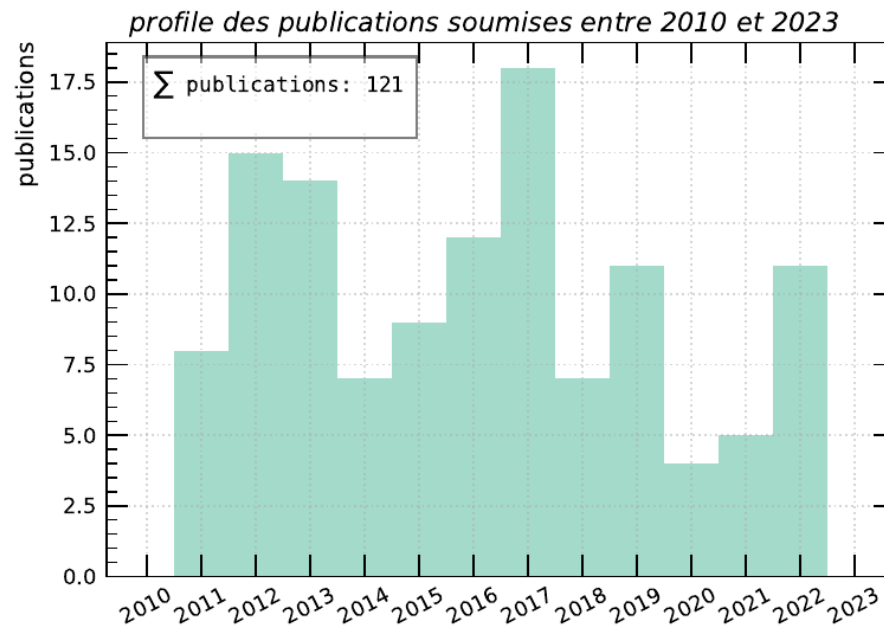

- ▶ We contributed to 121 / 655 papers or ~18% of LHCb publications

LHCb France contributes to many key measurements

CP Violation

- CKM angle γ
- Phase ϕ_s
- $A_{CP}(B_{(s)} \rightarrow \pi\pi\pi, K\pi\pi, \dots)$

Rare decays

- $\mathcal{B}(B_s \rightarrow \mu\mu, \mu\mu\gamma, \tau\tau)$
- Angular analysis of $B^0 \rightarrow K^* \mu\mu$ decay
- $R(K^+), R(K^*)$
- Search of LFV

Charm

- Mixing parameter
- CP violation in D^0 decays, ΔA_{CP}

Semileptonic $b \rightarrow cl\nu_l$

- $R(D^*)$
- $R(\Lambda_c)$

Photon polarisation

- $B^0 \rightarrow K^* \gamma$
- $B_s \rightarrow \phi \gamma$
- Angular analysis of $B^0 \rightarrow K^* ee$ at low q^2

Spectroscopy

- $\chi_{b1}(1P), \chi_{b2}(1P) (b\bar{b})$
- $\Xi_{cc}^{++} (ccu), \Xi_b^- (bsd)$
- $T_{c\bar{s}0}^a(2900)^{++} (c\bar{s}u\bar{d})$
- $T_{c\bar{s}0}^a(2900)^0 (c\bar{s}\bar{u}d)$

Heavy Ions see talk from F. Fleuret

Highlight of our contributions to *CP Violation*

► Angle γ

Publications IN2P3 contributions	
PAPER-2013-020	PAPER-2016-007
PAPER-2016-032	PAPER-2017-047
PAPER-2018-015	PAPER-2021-027
Analyses ongoing	

- By combining 15 beauty and 9 charm decays, simultaneous measurement of the angle γ and $D^0 - \bar{D}^0$ mixing parameters

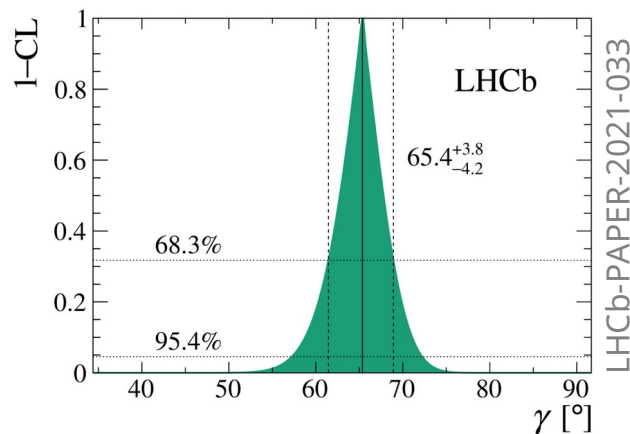

$$\gamma = (65.4^{+3.8}_{-4.2})^\circ$$

The most precise measurement of γ by a single experiment

► $\phi_s = 2 \arg[(V_{ts} V_{tb}^*) / (V_{cs} V_{cb}^*)]$

Publications with IN2P3 contributions	
PAPER-2011-021	PAPER-2013-002
PAPER-2014-059	PAPER-2022-010

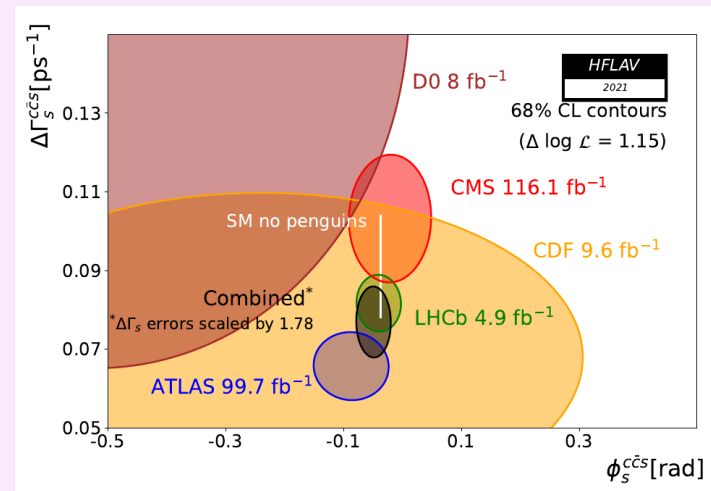

$$\phi_s^{LHCb} = -42 \pm 25 \text{ mrad}$$

$$\phi_s^{\text{SM no penguin}} = -37 \pm 1 \text{ mrad}$$

LHCb-PAPER-2019-013

Highlight of our contributions to *Rare decays*

► Branching ratio $\mathcal{B}(B_s \rightarrow \mu\mu)$

Publications with IN2P3 contributions	
PAPER-2011-004	PAPER-2011-025
PAPER-2012-007	PAPER-2013-046
PAPER-2014-049	PAPER-2017-001

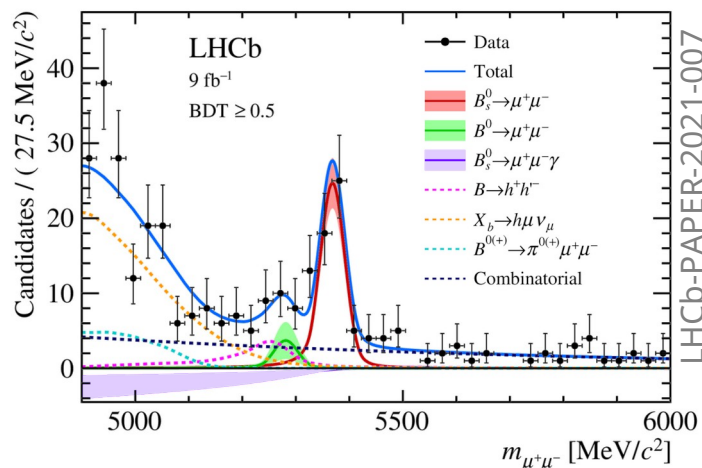

$$\begin{cases} \mathcal{B}(B_s^0 \rightarrow \mu^+ \mu^-) = (3.09^{+0.46+0.15}_{-0.43-0.11}) \times 10^{-9} \\ \mathcal{B}(B^0 \rightarrow \mu^+ \mu^-) < 2.6 \times 10^{-10} \text{ 95\%CL} \end{cases}$$

The most precise measurement of $\mathcal{B}(B_s \rightarrow \mu\mu)$ by a single experiment

► Angular analysis $B^0 \rightarrow K^* e e$ decay at low q^2

Publications with IN2P3 contributions	
PAPER-2014-066	PAPER-2020-020

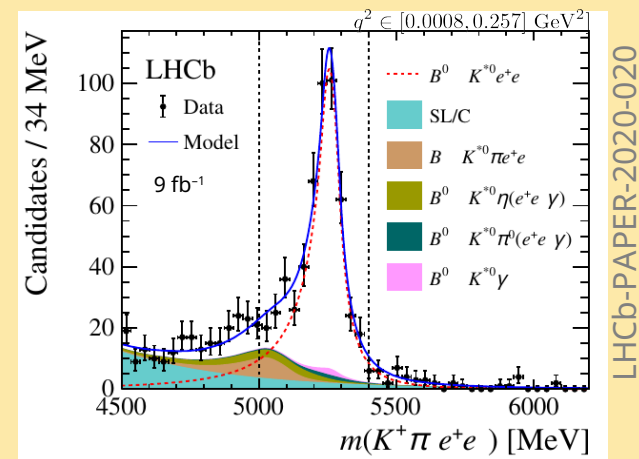

$$\begin{aligned} A_T^{(2)} &= +0.11 \pm 0.10 \pm 0.02 & \Rightarrow & \text{Re}(A_R/A_L) = 0.05 \pm 0.05 \\ A_T^{Im} &= +0.02 \pm 0.10 \pm 0.01 & & \text{Im}(A_R/A_L) = 0.01 \pm 0.05 \end{aligned}$$

The world most precise measurement of photon polarisation which is compatible with Standard Model predictions

Highlight of our contributions to *Lepton flavour universality*

▶ Test of $R(K^+)$ and $R(K^*)$

$$R_K = \frac{\int_{q_{\min}^2}^{q_{\max}^2} \frac{d\Gamma[B^+ \rightarrow K^+ \mu^+ \mu^-]}{dq^2} dq^2}{\int_{q_{\min}^2}^{q_{\max}^2} \frac{d\Gamma[B^+ \rightarrow K^+ e^+ e^-]}{dq^2} dq^2}$$

Publications with IN2P3 contributions	
PAPER-2017-013	PAPER-2022-045
PAPER-2022-046	

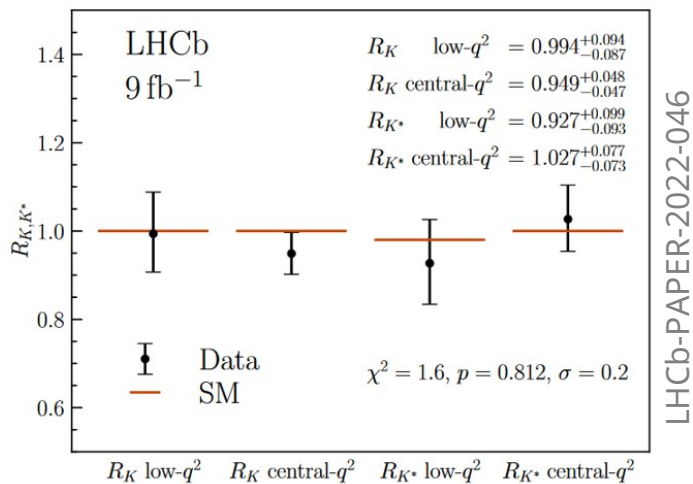

▶ In agreement with SM predictions

▶ Test of $R(D^*)$

$$\mathcal{R}(D^*) = \frac{\mathcal{B}(\bar{B}^0 \rightarrow D^{*+} \tau^- \bar{\nu}_\tau)}{\mathcal{B}(\bar{B}^0 \rightarrow D^{*+} \mu^- \bar{\nu}_\mu)}$$

Publications with IN2P3 contributions	
PAPER-2017-017	PAPER-2017-027
Analyses ongoing	

$$\mathcal{R}(D^*)^{2018} = (0.283 \pm 0.019 \pm 0.026 \pm 0.013)$$

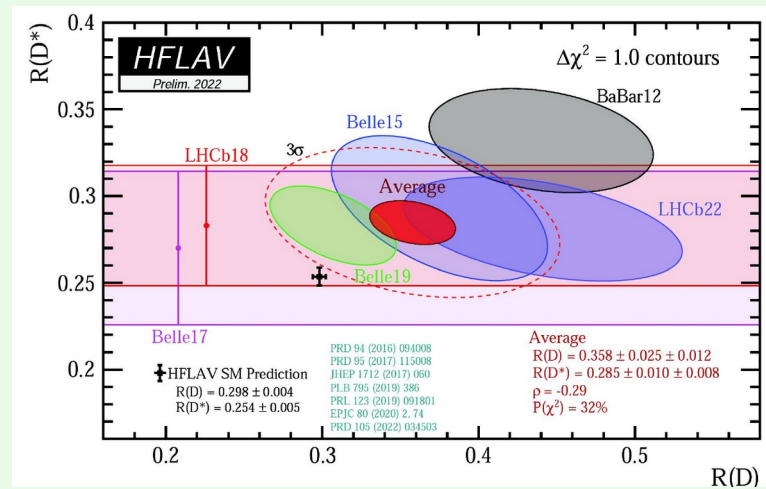

▶ Simultaneous measurement of $R(D)$ and $R(D^*)$, deviation at the level of 3.2σ

Many expertise, international collaborations, ...

► Expertise:

- Reconstruction of electrons, γ , π^0 and τ
- Amplitude analyses of multi-body decays
- Flavour tagging and time dependent analysis
- Luminosity

► International collaborations:

China	Peking University, Tsinghua, UCAS, Wuhan
Germany	Aachen, Dortmund, Heidelberg
Hungary	Budapest
Italy	Bologna, Ferrara, Milano
Netherlands	Maastricht
Poland	Krakow
Russia	Novossibirsk
Spain	Barcelona, Santiago de Compostela, Valencia
Switzerland	CERN
United Kingdom	Birmingham, Edinburgh, Glasgow, Manchester, Oxford, Warwick
USA	Cincinnati

- As well as grants for 4 ERCs and 7 ANR projects

Physics case for LHCb Upgrade II

- ▶ The LHCb Upgrade I will greatly improve the sensitivity of many flavour studies. However, the precision on most of measurements will still be limited by statistics, and other observables associated with highly suppressed processes will still be poorly known.

There is therefore strong motivation to build LHCb Upgrade II in order to fully realise the flavour-physics potential of the HL-LHC.

- ▶ This ambitious program matches:
 - 2020 Update of the European Strategy for Particles physics: *The full physics potential of the LHC and the HL-LHC, including the study of flavour physics and the quark-gluon plasma, should be exploited*
 - Science Drivers of *prospective nationale en physique nucléaire, physique des particules et astroparticules*: *Study of matter-antimatter asymmetry and flavor transitions in the quark sector + Test lepton universality and search for charged lepton flavour violation*
 - IN2P3 roadmap published end 2022: *Prepare a sustainable experimental flavour physics program beyond 2030.*

Our motivations for the LHCb Upgrade II

- ▶ Based on our strong expertise, push to the limit key measurements in order to reveal physics beyond the SM and to understand its nature
- ▶ Be agile and keep flexibility in selected analyses to follow a possible change of paradigm
- ▶ Continue to build collaborations within IN2P3 and with international institutes

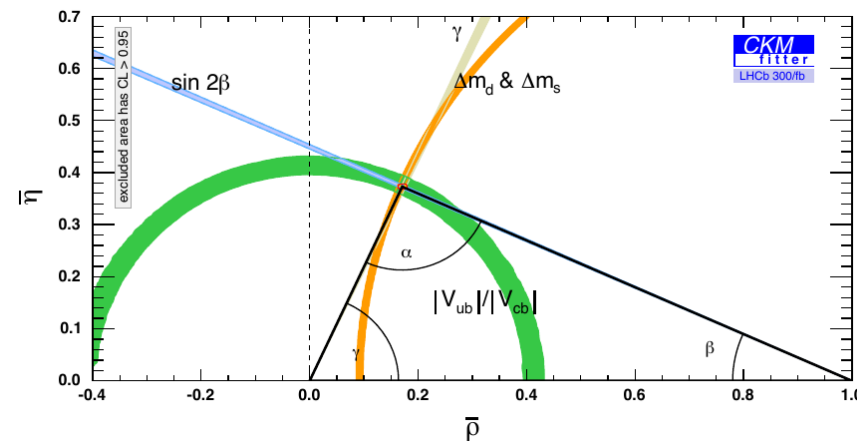
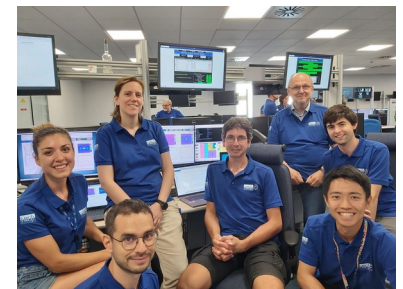
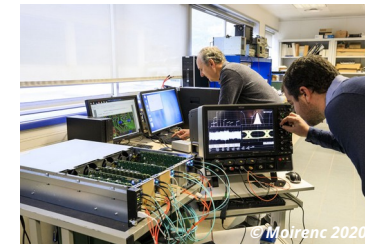

Anticipated uncertainties at future LHCb Upgrades

Observable	Current LHCb (up to 9 fb ⁻¹)	Upgrade I (23 fb ⁻¹)	Upgrade I (50 fb ⁻¹)	Upgrade II (300 fb ⁻¹)
CKM tests				
γ ($B \rightarrow DK$, etc.)	4° [9,10]	1.5°	1°	0.35°
ϕ_s ($B_s^0 \rightarrow J/\psi\phi$)	32 mrad [8]	14 mrad	10 mrad	4 mrad
$ V_{ub} / V_{cb} $ ($\Lambda_b^0 \rightarrow p\mu^-\bar{\nu}_\mu$, etc.)	6% [29,30]	3%	2%	1%
a_{sl}^d ($B^0 \rightarrow D^-\mu^+\nu_\mu$)	36×10^{-4} [34]	8×10^{-4}	5×10^{-4}	2×10^{-4}
a_{sl}^s ($B_s^0 \rightarrow D_s^-\mu^+\nu_\mu$)	33×10^{-4} [35]	10×10^{-4}	7×10^{-4}	3×10^{-4}
Charm				
ΔA_{CP} ($D^0 \rightarrow K^+K^-, \pi^+\pi^-$)	29×10^{-5} [5]	13×10^{-5}	8×10^{-5}	3.3×10^{-5}
A_Γ ($D^0 \rightarrow K^+K^-, \pi^+\pi^-$)	11×10^{-5} [38]	5×10^{-5}	3.2×10^{-5}	1.2×10^{-5}
Δx ($D^0 \rightarrow K_s^0\pi^+\pi^-$)	18×10^{-5} [37]	6.3×10^{-5}	4.1×10^{-5}	1.6×10^{-5}
Rare Decays				
$\mathcal{B}(B^0 \rightarrow \mu^+\mu^-)/\mathcal{B}(B_s^0 \rightarrow \mu^+\mu^-)$	69% [40,41]	41%	27%	11%
$S_{\mu\mu}$ ($B_s^0 \rightarrow \mu^+\mu^-$)	—	—	—	0.2
$A_\Gamma^{(2)}$ ($B^0 \rightarrow K^{*0}e^+e^-$)	0.10 [52]	0.060	0.043	0.016
A_Γ^{Im} ($B^0 \rightarrow K^{*0}e^+e^-$)	0.10 [52]	0.060	0.043	0.016
$\mathcal{A}_{\phi\gamma}^{\Delta\Gamma}$ ($B_s^0 \rightarrow \phi\gamma$)	$^{+0.41}_{-0.44}$ [51]	0.124	0.083	0.033
$S_{\phi\gamma}$ ($B_s^0 \rightarrow \phi\gamma$)	0.32 [51]	0.093	0.062	0.025
α_γ ($\Lambda_b^0 \rightarrow \Lambda\gamma$)	$^{+0.17}_{-0.29}$ [53]	0.148	0.097	0.038
Lepton Universality Tests				
R_K ($B^+ \rightarrow K^+\ell^+\ell^-$)	0.044 [12]	0.025	0.017	0.007
R_{K^*} ($B^0 \rightarrow K^{*0}\ell^+\ell^-$)	0.12 [61]	0.034	0.022	0.009
$R(D^*)$ ($B^0 \rightarrow D^{*-}\ell^+\nu_\ell$)	0.026 [62,64]	0.007	0.005	0.002

Framework TDR, LHCb-TDR-023

Interests in Calorimetry (ECAL Upgrade II)

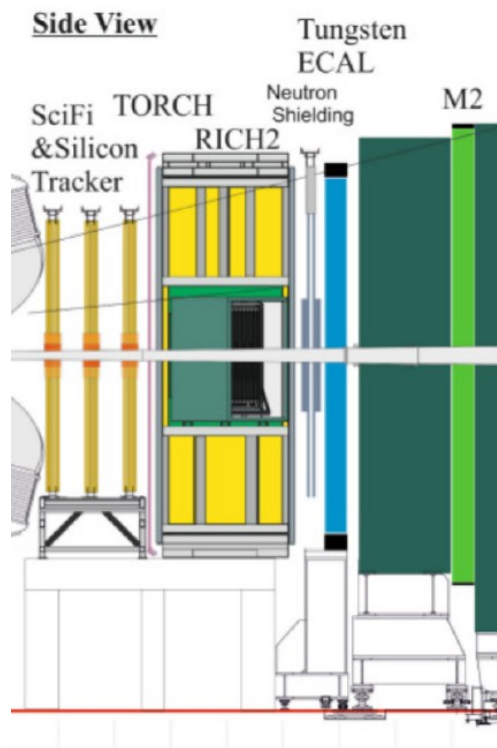

IJCLab
LAPP
LPC

Highlight of our contributions to Calorimetry

► LHCb:

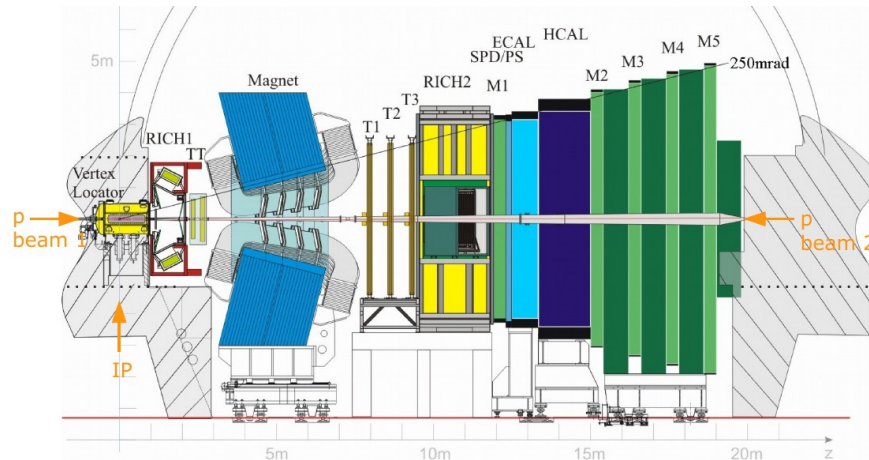

Qualification and tests of PMs CALO, MAPMTs PS/SPD	IJCLab, LPC
Mechanics CALO and PS/SPD	LAPP
Electronics FE CALO and PS/SPD running at 1 MHz	IJCLab, LAPP, LPC
Simulation and reconstruction of CALO objects	IJCLab, LPC
Project Leaders	IJCLab, LAPP, LPC

► LHCb Upgrade I:

Dismount PS/SPD + update mechanics CALO	LAPP, LPC
Electronics FE CALO running at 40 MHz	IJCLab
Readout firmware	LAPP
Reconstruction of CALO objects	LAPP
Project Leader	IJCLab

Current ECAL

Optimized for γ and π^0 reconstruction in the few to 100 GeV energy range at $\mathcal{L} = 2 \times 10^{32} \text{ cm}^{-2} \text{ s}^{-1}$

- 3312 shashlik modules and 6016 channels
- Radiation resistant up to 40 kGy
- Three sections (Inner, Middle, Outer) of cell size 4×4 , 6×6 and $12 \times 12 \text{ cm}^2$
- $\sigma_E/E \sim 10\%/\sqrt{E} \oplus 1\%$

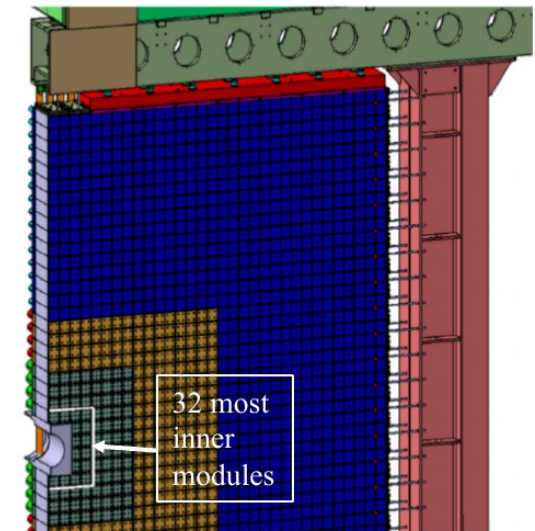
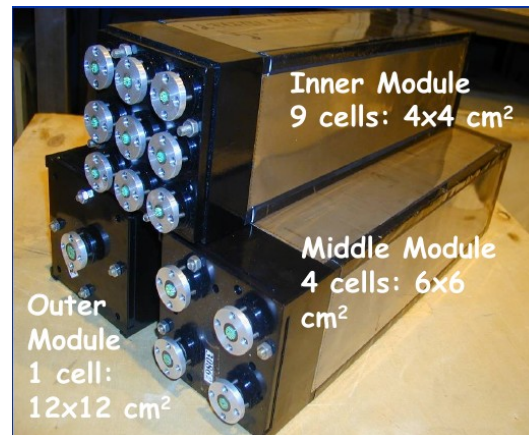
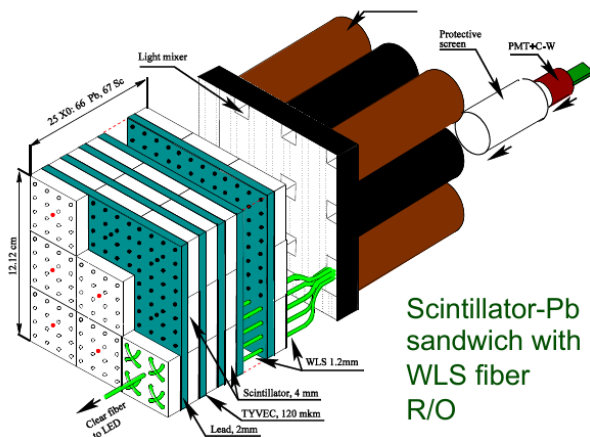
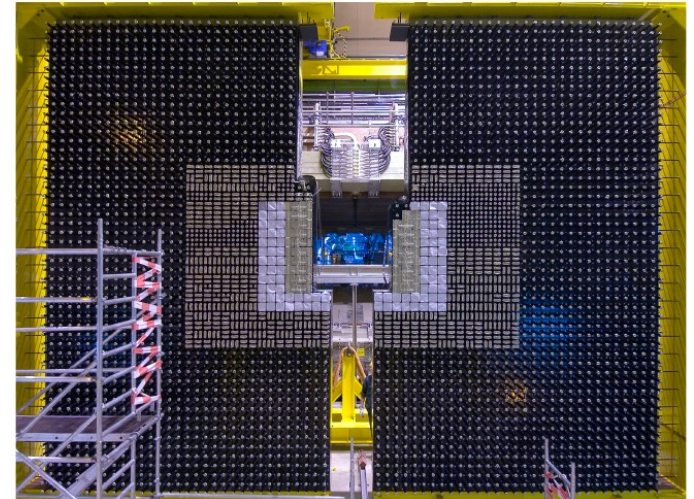

ECAL under Upgrade II conditions

- ▶ Operation up to $\mathcal{L} = 1.5 \times 10^{34} \text{ cm}^{-2} \text{ s}^{-1}$
- ▶ Keep current energy resolution and performance
- ▶ Sustain radiation dose up to 1 MGy
- ▶ Mitigate high occupancy and pile-up by:
 - Increasing granularity up to $1.5 \times 1.5 \text{ cm}^2$
 - Follow rhombic shape radiation map
 - Add timing capabilities $\mathcal{O}(10) \text{ ps}$
 - Improve PID by introducing Z segmentation

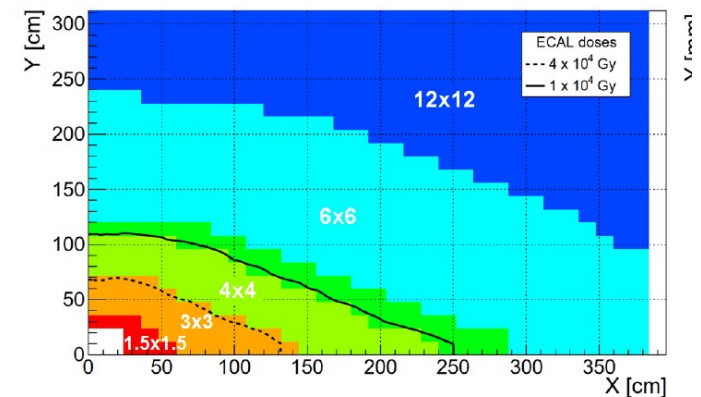

SPACAL

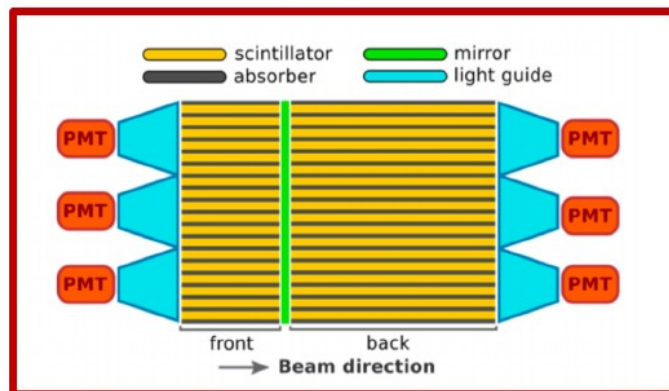

W or Pb absorber

Scintillating crystal or plastic fibres

Shashlik

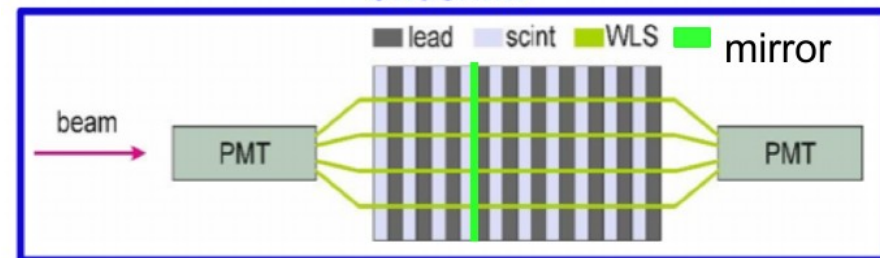

Evolution of ECAL during LS3

At the end of Run 3, the 32 inner most modules will be completely inefficient.

- ▶ Replace inner most (32) and adjacent modules (144) with SpaCal $2 \times 2 \text{ cm}^2$ and $3 \times 3 \text{ cm}^2$ modules, equipped with plastic scintillating fibres
- ▶ Rearrange the existing $4 \times 4 \text{ cm}^2$, $6 \times 6 \text{ cm}^2$, $12 \times 12 \text{ cm}^2$ Shashlik modules according to the occupancy map
- ▶ Equip new SpaCal modules with FE Electronics required for LS4 (timing, single R/O, no longitudinal segmentation) → 3 456 channels

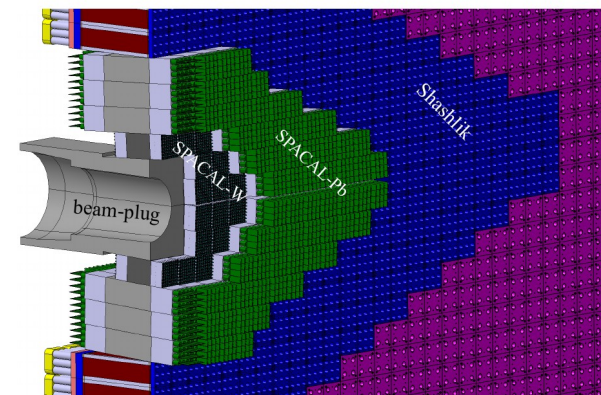
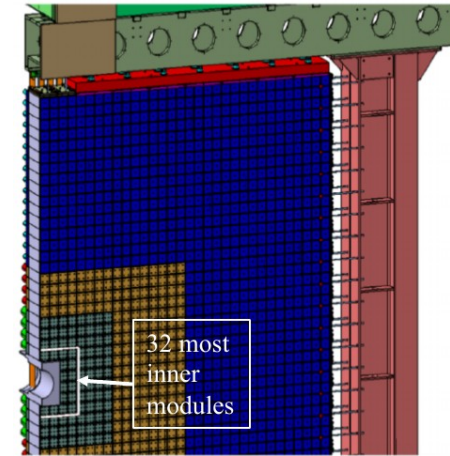

Evolution of ECAL during LS4

Configuration:

<u>Cell size:</u>	<u>Modules:</u>
1.5 x 1.5 cm ²	32 <i>new</i> W-SPACAL for extreme conditions of up to 1 MGy
3 x 3 cm ²	144 <i>new</i> Pb-SPACAL with “moderate” radiation requirements of up to \approx 200 kGy
4 x 4 cm ²	272 <i>new</i> Shashlik + 176 <i>refurbished</i> existing Shashlik with long. segmentation
6 x 6 cm ²	896 <i>new</i> Shashlik + 448 <i>refurbished</i> existing Shashlik with long. segmentation
12 x 12 cm ²	1344 <i>refurbished</i> Shashlik modules with long. segmentation

Number of channels SpaCal and Shashlik double-sided R/O	30 208
Number of FE boards (64 channels / board)	472

Proto-collaboration

Well advanced.

Definition of work packages is going on and groups are subscribing.

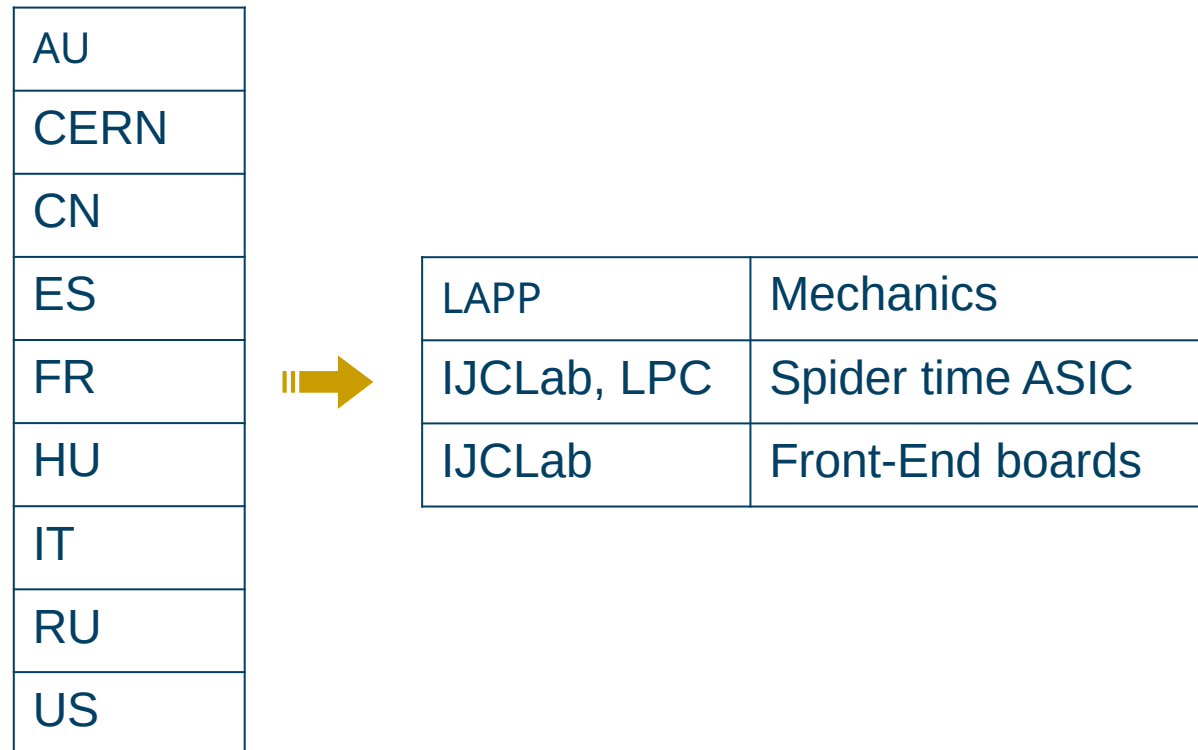

*Institutional interest
in the Framework TDR*

- ▶ The installation of the current ECAL modules was easy compared to the required infrastructure work for the Upgrade II configuration
- ▶ To be studied:
 - Dismantling of platforms
 - Dismantling of Shashlik modules
 - Modification of support structures
 - Design of required tooling
 - Cable routing and installation
 - Installing/Connecting modules
 - Confining modules
 - Beam plug installation
 - Installing platforms and racks on top
- ▶ Modifications in one go during LS3

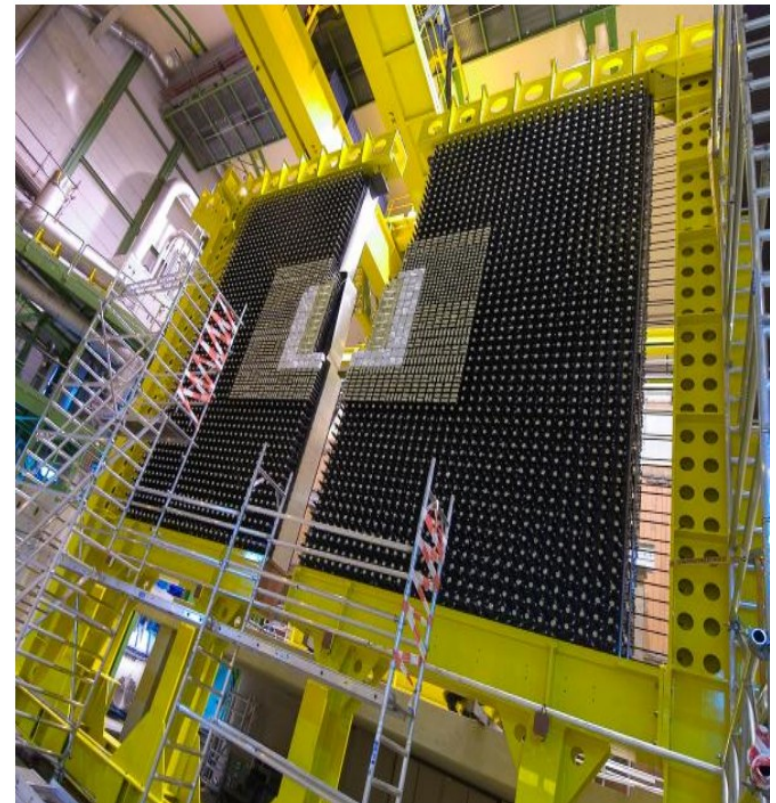

The Spider Time ASIC

IJCLab, LPC

- ▶ Challenging time measurement based on Waveform Time-to-Digital converter in analogue memories and a digital Constant Fraction Discriminator in FPGA

Resolution of entire chain	20 ps RMS
Dynamic range E_T	50 MeV up to 5 GeV
Average Cell occupancy	10 %
Process up to consecutive event	8

State-of-the art technology offering good resolution at high energy and allows to compensate for time walk effect

- ▶ R&T funded by IN2P3 for 2 years [2022, 2023]
IJCLab, LPC, LPCC, IP2I Lyon

- ▶ Prototype to be deployed during LS3:
500 ASIC

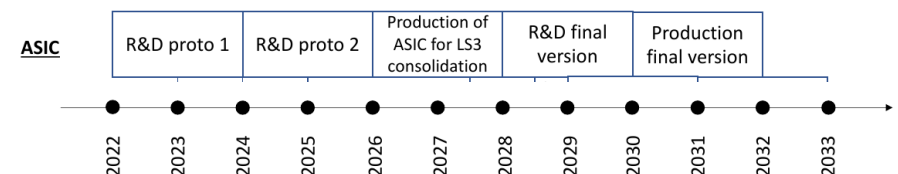

The new front-end electronics

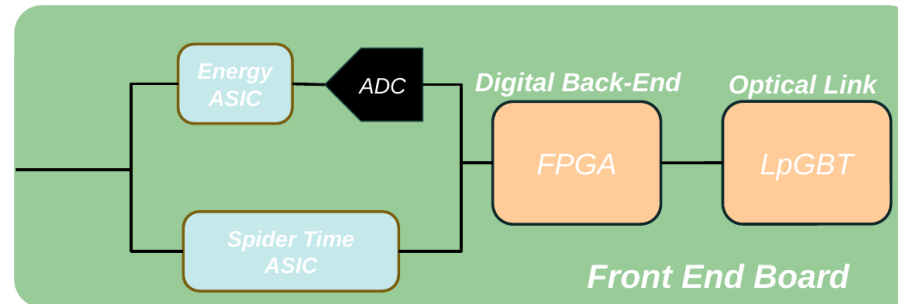

- ▶ Design of the Front-End board not yet covered in LHCb. Interest from IJCLab team to participate and to lead this project:
 - Re-use all experience acquired in the last 15 years
 - Ensure leadership on the electronics for ECAL Upgrade II
 - Interesting challenges: complex data processing in the board's FPGA for time measurement for example
- ▶ Big project: infrastructure, backplanes, crates, power supplies, ... Need to find collaborations in IN2P3 or in other LHCb groups
- ▶ Prototype to be deployed during LS3: 110 FE boards, 10 Controllers

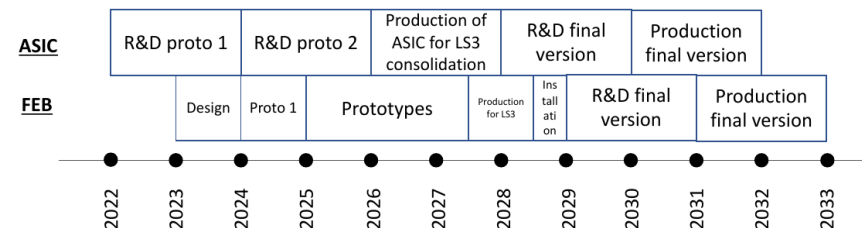

Technology interests for IN2P3

- ▶ IJCLab plays a world leading role in TDC with very high resolution:
 - Push this start-of-the art technology in harsh condition reaching resolution of $\mathcal{O}(10)$ ps while dealing with high input rate (40 MHz), large dynamic range (100) and many channels (30×10^3)
 - Opportunity to share expertise between IN2P3 laboratories

- ▶ Develop ASIC with 65 nm TSMC CMOS technology:
 - New standard for IN2P3
 - Pave the way to the future in ASIC design

Interests in Trajectory (UT Upgrade II)

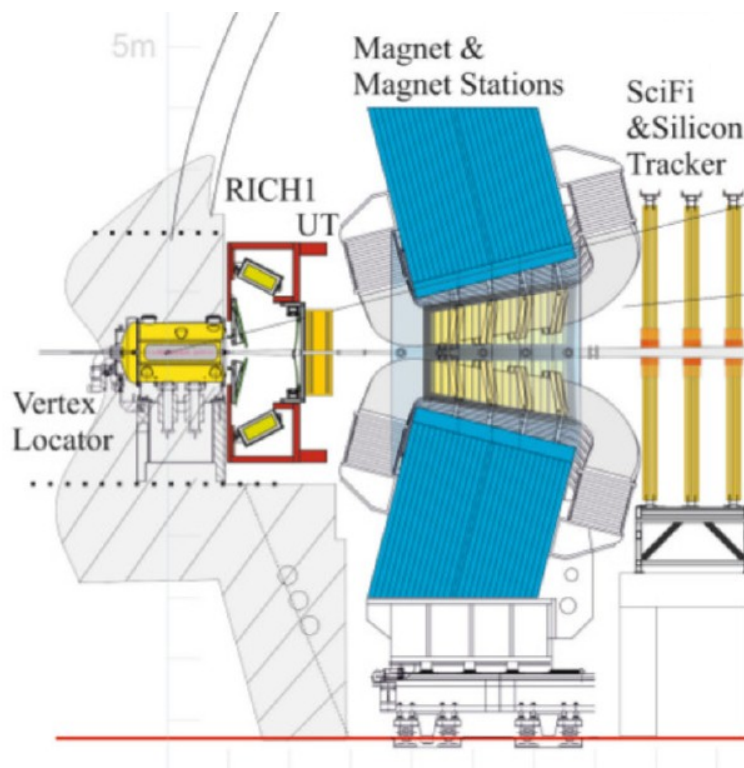

LLR
LPNHE
Subatech (applying for U II)
IRFU (Technical associated)

Highlight of our contributions to Trajectoryography

- ▶ LHCb:
 - Track reconstruction (IJCLab)

- ▶ LHCb Upgrade I – SciFi:

ASIC PACIFIC	LPC
FE boards and their cooling	LPC
Readout firmware	LPNHE
Detector simulation and pattern recognition	IJCLab, LPC, LPNHE

UT for Upgrade I

Facilitate the track matching between the VELO and SCiFi segments and therefore strongly reduce the fake matches, improve the momentum resolution and provide a fast estimate of momentum for trigger:

- $\mathcal{L} = 2 \times 10^{33} \text{ cm}^{-2} \text{ s}^{-1}$
- Radiation resistant up to $\int \mathcal{L} = 50 \text{ fb}^{-1}$
- 4 stereo planes $xuvx$ with a strip pitch $\sim 100 \mu\text{m}$ and length 50 to 100 mm
- 68 staves, 968 sensors, 4 192 ASICS

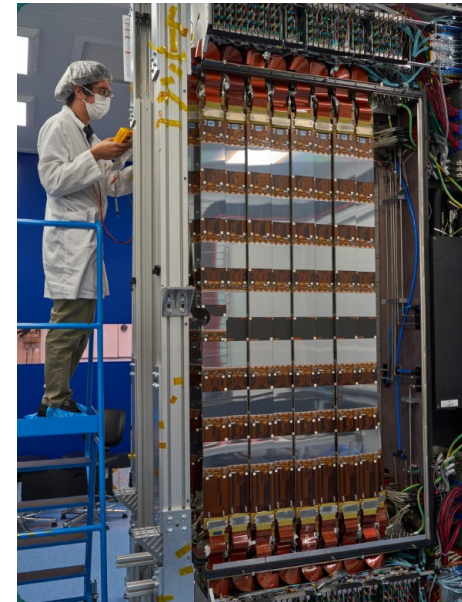
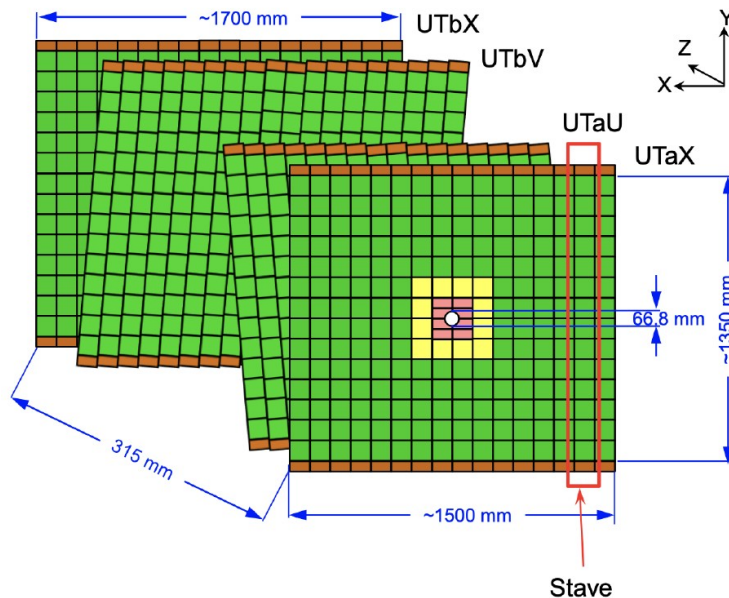

UT under upgrade II conditions

- ▶ Operation up to $\mathcal{L} = 1.5 \times 10^{34} \text{ cm}^{-2} \text{ s}^{-1}$
- ▶ Sustain radiation dose up to $3 \times 10^{15} \text{ n}_{\text{eq}}/\text{cm}^2$ in the inner region
- ▶ Mitigate high occupancy and pile-up by:
 - Replacing strip with CMOS MAP pixel
 - 4 planes, 48 staves, 1 728 modules, 21 192 ASICs

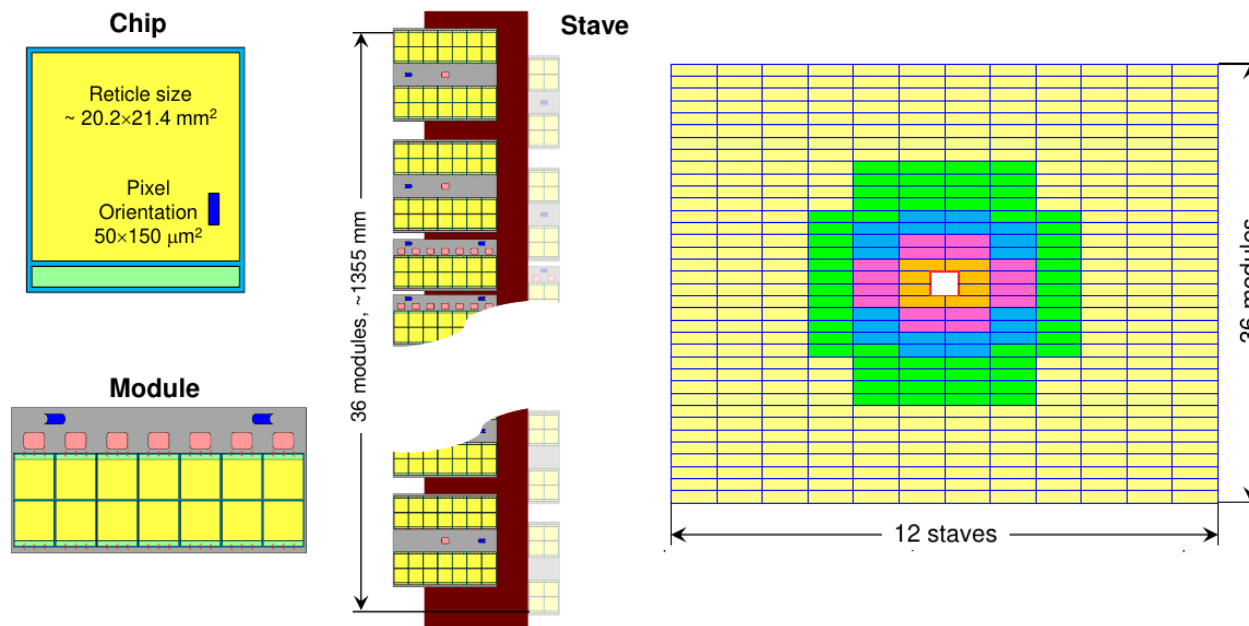

Technologies for CMOS Map

▶ HV-CMOS:

- Baseline for the Mighty Tracker
- Existing chips AMS/TSI 180: MuPix, ATLASPix

▶ LV-CMOS:

- Technology developed at CERN, IN2P3, IRFU, Bonn
- Existing chips Tower Jazz 180: ALPIDE, MALTA2, TJ-MONOPIX 2

Characteristics	LV-CMOS	HV-CMOS
Chip size	$3.5 \times 3.5 \text{ cm}^2$	$2.0 \times 2.0 \text{ cm}^2$
Pixel size	$30 \times 30 \text{ }\mu\text{m}^2$	$50 \times 150 \text{ }\mu\text{m}^2$
Chip thickness		100 μm
Position resolution	5–10 μm	15, 40 μm
Time resolution		O(1 ns)
Power consumption		100–300 mW/cm ²
Data rate per chip	Up to 30 Gb/s	Up to 9 Gb/s
Radiation dose	$3 \times 10^{15} \text{ n}_{\text{eq}}/\text{cm}^2$, and 240 Mrad TID	

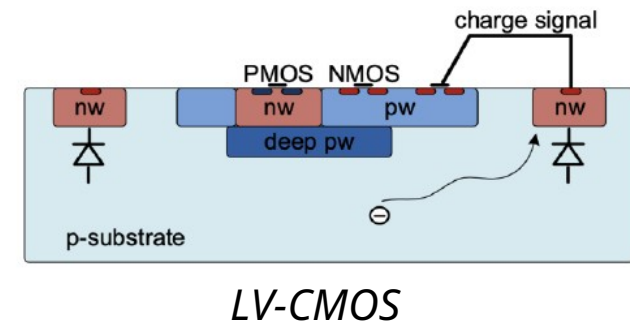

- ▶ Final choice on MAPS technology shall be based on refined and consolidated detector specifications and R&D
- ▶ Many overlapping requirements between UT and Mighty Tracker. Discussions have started to study the possibility of a common ASIC

Proto-collaboration

Incubation phase.

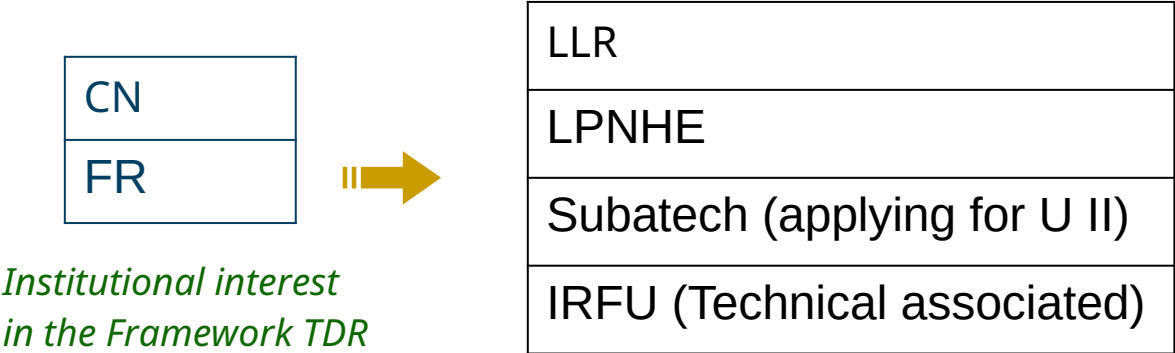

Our interests

Internal discussions between French teams to define work packages and possible contributions. Such organisation is not official within proto-collaboration

Work package	Task	FR Interest	ETP / y
WP0 – coordination			
WP1 – simulations and performances pp and PbPb	<ul style="list-style-type: none"> •Physics performances •Occupancy, Tracking and reconstruction •Geometry and material budget 	LLR LPNHE IRFU Subatech	~2 – 2.5
WP2 – chip design and characterization	<ul style="list-style-type: none"> •Pixel design and optimization •Chip design and simulation •Demonstrator and prototype production •Test bench design and building •Characterization of prototypes 	LLR IRFU	~1.5 – 2
WP3 – module stave and mechanical structure	<ul style="list-style-type: none"> •Flex (FPC) design and pototype production •Structure design and prototype production •Cooling studies 	IRFU Subatech	~1.5 – 2
WP4 – overall mechanics, integration and services	<ul style="list-style-type: none"> •Global mechanics design •Integration in LHCb •Power, cooling and readout services design 	Subatech	~0.5 – 1
WP5 – readout	<ul style="list-style-type: none"> •Data throughput studies •Architecture design •Data links optimization •Frontend/backend card design and prototypes •Integration into LHCb DAQ 	LPNHE Subatech	~1 – 1.5

Opportunity

- ▶ Taken apart, individual contributions foreseen by interested teams are relatively modest.
- ▶ But a joint venture between laboratories can provide larger human resources. Engineers and physicists from different laboratories work together on the same project independently of their locations.
- ▶ Although we are not able to take the full load of the UT for Upgrade 2, we can play a leading role in the organisation, in the the technical coordination as well as in technological choices of such a complicated detector.
- ▶ This ambitious approach is a strong scientific choice matching recommendation from *les Prospectives Techniques de l'IN2P3: renforcer l'approche multi-laboratoire, afin de mener les projets de taille significative en mettant en commun les savoirs et compétences*

Technology interests for IN2P3

- ▶ Preserve and improve current expertise:
 - Detector mechanics, integration and services
 - ASIC characterisation and qualification
 - Firmware development for leading edge macro FPGA
- ▶ Prepare the new generation of engineers and physicists to design, build and operate complex detectors in harsh environment

Interests in DAQ and RTA

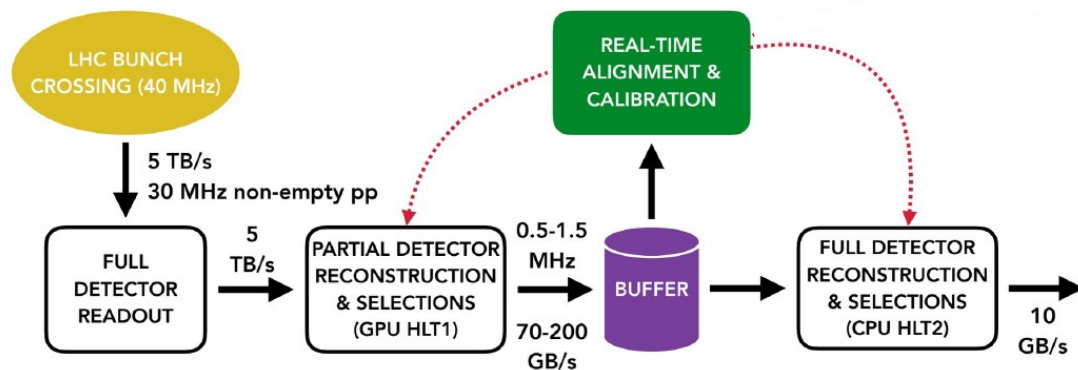

Data flow for LHCb Upgrade I

CPPM
IJCLab
LAPP
LPNHE

Highlight our contributions DAQ / RTA

► LHCb:

Trigger L0	Calo	IJCLab, LAPP, LPC
	Muon	CPPM
	Decision Unit	LPC
	Project Leader	CPPM

► LHCb Upgrade I:

Dismount L0	
Generic readout board PCIe40 + Project Leader	CPPM
Readout firmware framework and development	LAPP, LPNHE
HLT1 on GPU (Allen)	LPNHE, CPPM
Reconstruction of CALO objects + calibration	LAPP, IJCLab
Trajectory VELO, VELO-UT, etc	LPNHE
Project Leader RTA	LPNHE

Trigger less DAQ for Upgrade I

- ▶ In the Upgrade I conditions, large fractions of pp collisions contain interesting signals
- ▶ In such conditions, the DAQ system:
 - builds full event for each bunch crossing
 - selects interesting signal decays with optimal efficiencies by running in almost real time off-line quality reconstruction

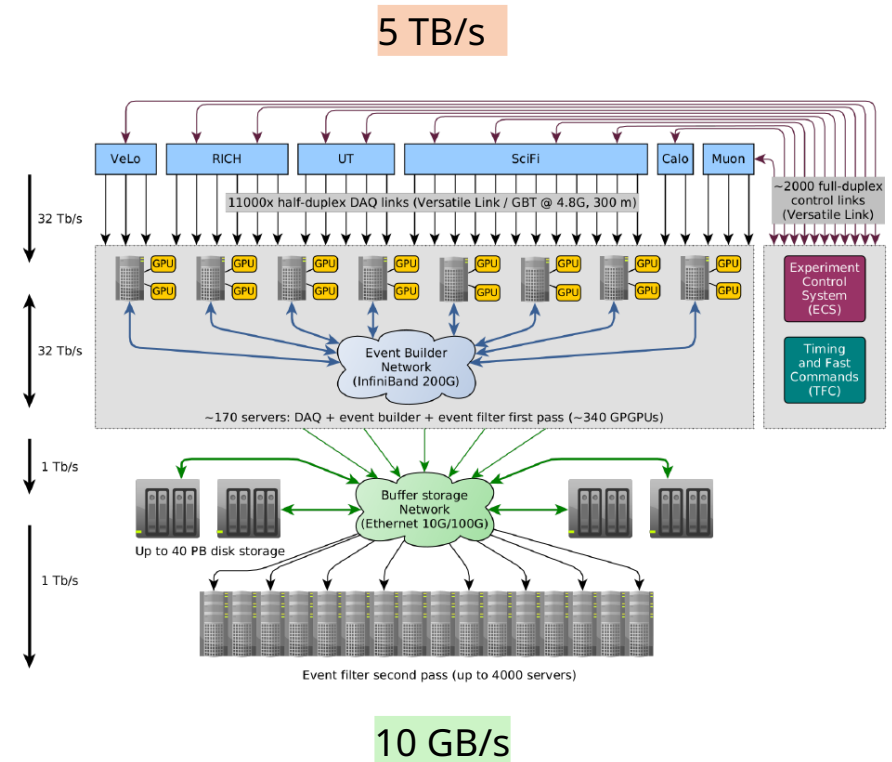

- ▶ Two stage processing:
 - Fast reconstruction and selection on farm of GPUs (HLT1)
 - Full reconstruction and selection on farm of CPUs (HLT2)

RTA project

- ▶ End 2018, the collaboration set-up the Real Time Analysis project. Software project to handle the software for HLT1 and HLT2
- ▶ The project is at the same level as a detector. It follows the same rules and it is part of the Technical Board
- ▶ We were the leading force to move to this new paradigm and we coordinated the project between 2018 and 2022

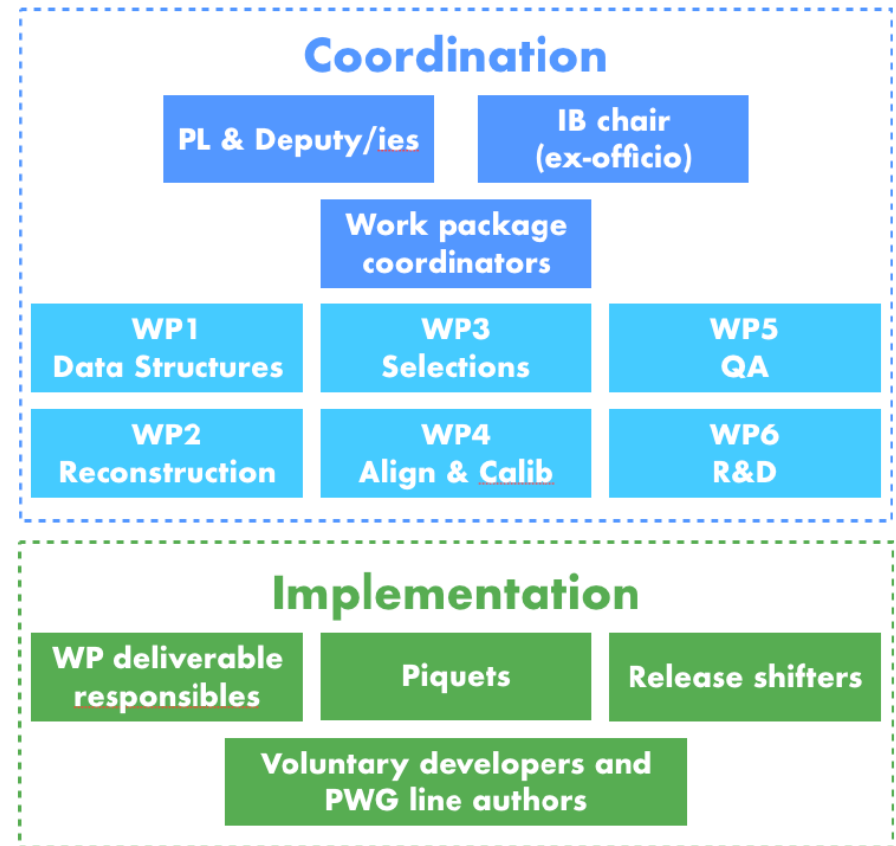

Allen - HLT1 - Fast reconstruction on GPU

- ▶ Pioneer work by LPNHE.
- ▶ Fast reconstruction and selection algorithms running on $\mathcal{O}(200)$ GPUs.

Embedded in the event builder PC-servers to reduce cost of downstream network, $\mathcal{O}(1\text{ M})$

- ▶ Generic heterogeneous multi-event software framework which is agnostic with respect to processor types and to vendors
- ▶ Interest in HEP community to use the framework for cross-experiment collaboration on reconstruction software

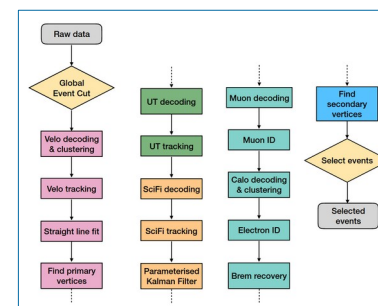
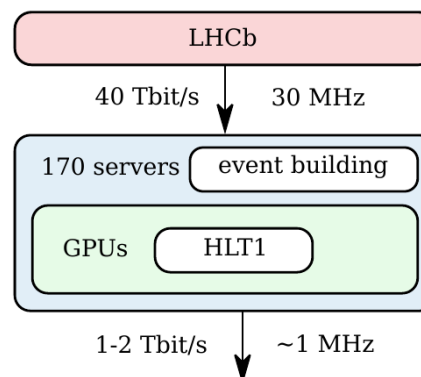

Fast reconstruction sequence

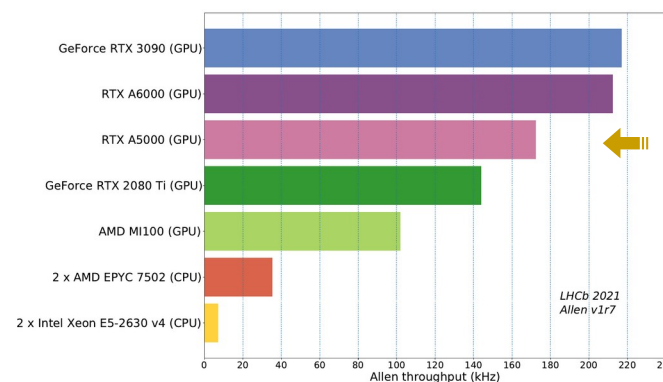

Allen performance versus processor type

DAQ evolution under Upgrade II conditions

DAQ is similar to Upgrade I, but with an input bandwidth of 25 TB/s, due to the large increase of detector channels:

- Almost all pp collisions contain a charm decay...
- The processing power for HLT2 scales quadratically with the *input rate* \times *input complexity*

Only farms of GPUs can provide the required processing power at an affordable cost

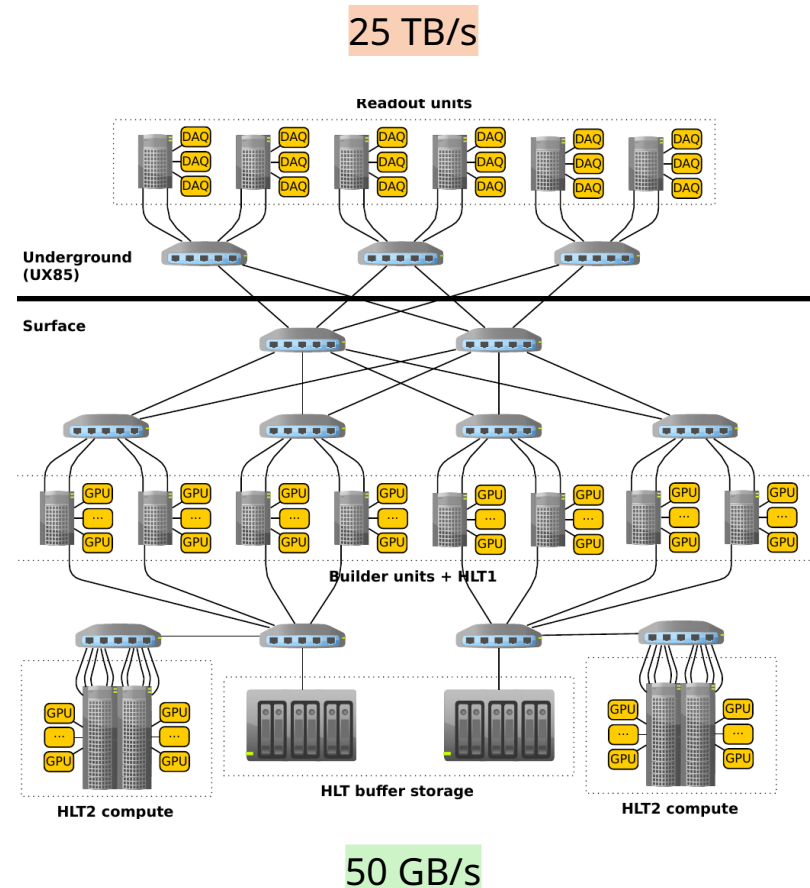

Proto-collaboration Readout Board

- ▶ In line with the PCIe40 project – no competitors

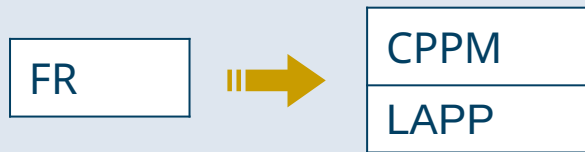

*Institutional interest
in the Framework TDR*

Our interests in readout board for LS3 and LS4

CPPM, LAPP

▶ The generic readout board is the first stage of the event builder interfacing:

- input streams on a custom protocol (IpGBT)
- output stream on data-centre protocol (PCIe GEN5)

▶ To accommodate timing requirement and the increase of channels in LS3, the successor of the PCIe40 is required:

- Bandwidth $\times 4$ (400 Gbits/s)
- Distribute clock at $\mathcal{O}(10)$ ps
- Network Interface (experimental)

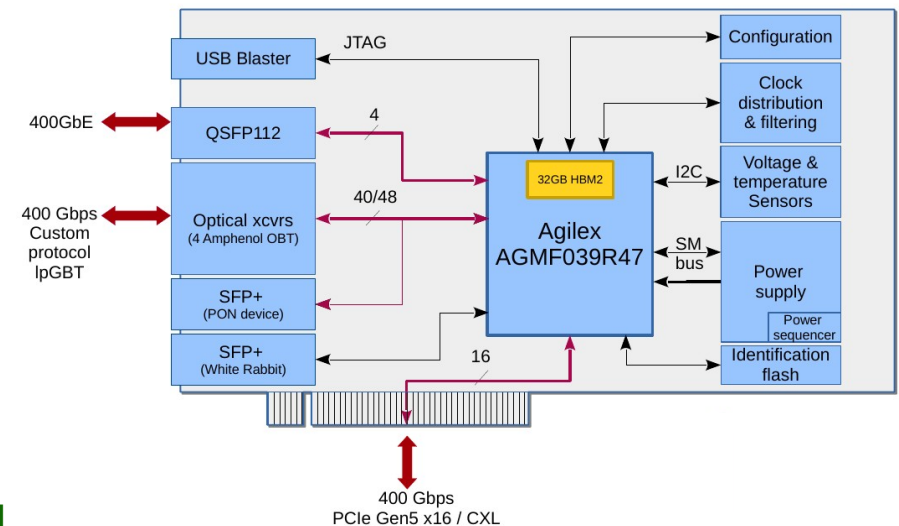

▶ R&T funded by IN2P3 for 3 years [2022, 2024]
CPPM, IJCLab, LAPP, LP2I, LPCC + CERN (LHCb/online)

▶ From 10 to ~100 boards to be deployed during LS3
(Possible interest from Belle II, CTA and ALICE collaborations)

▶ Second version for LS4 in which a bandwidth multiplied by at least a factor 2

Proto-collaboration RTA

► Natural evolution of the RTA project

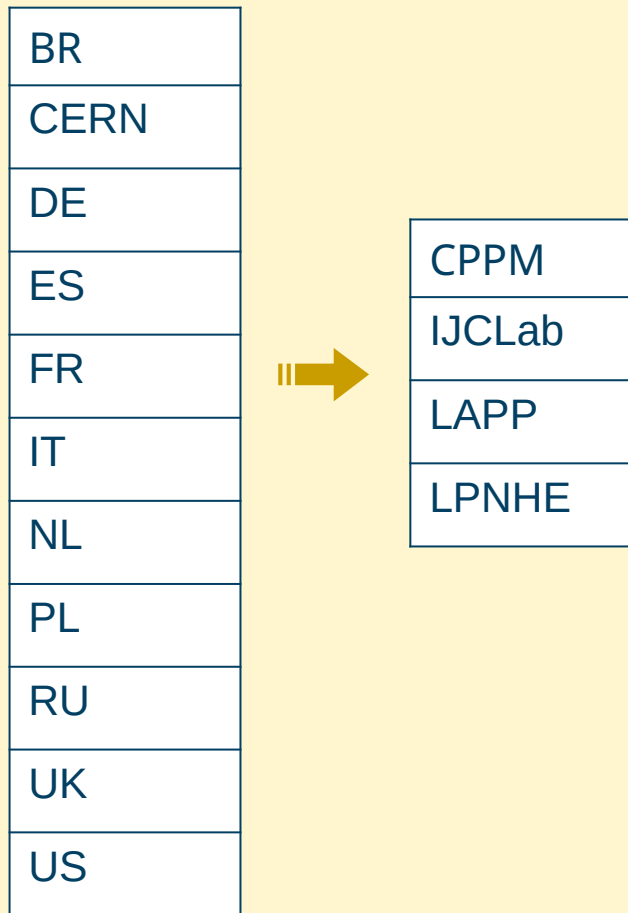

*Countries currently involved
in the RTA project*

Our interests in RTA

CPPM, IJCLab, LAPP, LPNHE

For the Upgrade II, pp collisions can contain up to 50 vertices and more than 2000 tracks

- Full reconstruction algorithms and event model on GPU
- Flexible framework to run efficiently the same code on different architectures: CPU, GPU, FPGA, etc.
- Optimise the processing flow from data encoding up to the event selection

- ▶ France would like to host one of the two European exaflop machines planned in Europe
- ▶ The program, Numerical for the Exascale (NUMPEX), was approved in 2022:
 - Design and develop the software building blocks that will equip future exascale machines
 - Prepare the major application domains to fully exploit the capabilities of these machines
- ▶ Exascale machines are a nice place to run the full LHCb reconstruction in almost real time and to reinforce our contributions to RTA
- ▶ We proposed to study:
 - High-throughput I/O mechanisms for transferring large amounts of data to exascale machines (DIRAC, ...)
 - Implementation of generic AI/ML models while preserving high performance and portability to different architectures

Technology interest for IN2P3

► Readout board

CPPM is one of the world leaders in high bandwidth readout boards:

- Push this state-of-the art technology to very high speed serial links, $\mathcal{O}(10)$ ps time distribution and latest generation of macro FPGA
- Generic boards for readout, slow control and time distribution which can open the doors to other collaborations with a modest investment

► Real Time Processing

Build a coherent team of IT engineers and physicists, with strong expertise in high performances computing:

Agnostic framework with respect to hardware architecture	Scheduler, memory manager, I/O, ...
Parallelisation, vectorization and code optimisation	C++, Cuda, ...
Deep knowledge of hardware platforms for optimum cost / performance and energy ratios	CPU, GPU, FPGA, ...
Industrial standard for code development and maintenance	

Milestones, staff and budget

Milestones

At this stage of the Upgrade II, milestones are TDR submissions by 2023 and 2026:

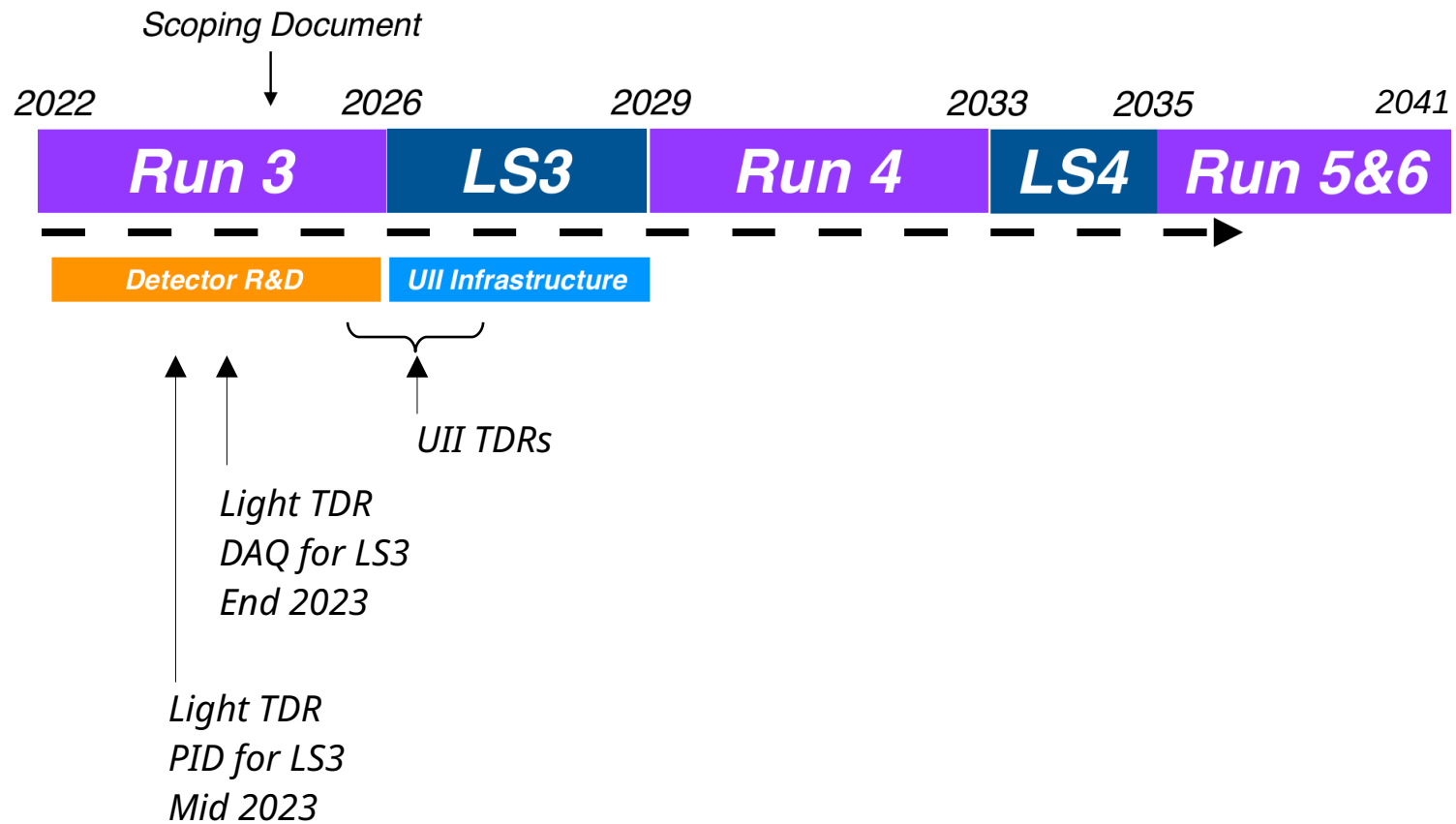

Estimation of technical staff

update with respect to IN2P3 LOI

FTE			Run 3				LS3			Run 4				LS4	Sum	
Project	Institutes	Staff	2022	2023	2024	2025	2026	2027	2028	2029	2030	2031	2032	2033		
ECAL	IJCLab + LAPP + LPC	management	0.3	0.3	0.3	0.3	0.3	0.4	0.3	0.4	0.4	0.4	0.3			
		microelectronics	1.7	5.7	5.7	4.1	4.1	2.5	2.5	2.5	2.5					
		electronics	0.3	1.0	3.0	3.0	3.0	1.5	2.5	1.5	1.5	1.5	0.5	1.5		
		mechanics	0.2	0.5	1.1	1.7	1.4	0.7	0.3							
		computing		1.0	1.0	1.0	1.0									
		instrumentation		0.3	0.3	0.3					0.3	0.3	0.3			
Subtotal			2.5	8.8	11.4	10.4	9.8	5.1	5.6	4.7	4.7	2.2	0.8	1.5	68	
UT	LPNHE + LLR + SUBATECH	management	0.3	0.3	0.3	0.3	0.3	0.3	0.3	0.3	0.3	0.3	0.3	0.3	0.3	
		electronics	0.4	1.1	2.5	2.7	2.6	2.6	2.6	2.6	2.6	2.6	1.6	1.6		
		mechanics	0.2	1.0	1.3	2.5	2.3	2.3	2.3	2.3	2.3	2.3	2.0	2.0		
Subtotal			0.9	2.4	4.1	5.5	5.2	5.2	5.2	5.2	5.2	3.9	3.9	52		
PCIe400	CPPM + CENBG + IJCLab + LAPP + LPCC	management	0.6	0.6	0.4	0.3	0.3	0.6	0.6	0.4	0.3	0.3				
		electronics	4.1	4.1	3.1			4.1	4.1	3.1						
		mechanics	0.5					0.5								
		computing														
		quality				1.0					1.0					
		instrumentation				2.0	3.0					2.0	3.0			
Subtotal			5.2	4.7	3.5	3.3	3.3	5.2	4.7	3.5	3.3	3.3		40		
RTA	LPNHE + CPPM + LLR + IJCLab + LAPP	management	0.8	0.3	0.3	0.8	0.8	0.8	0.8	0.3	0.3	0.3	0.3	0.8		
		electronics		0.7	0.7	0.7	0.5	0.5	0.5	0.5	0.5					
		computing	1.6	1.9	2.1	2.1	1.5	1.8	2.3	2.3	2.3	2.3	2.3	1.0		
		quality			0.3	0.3	0.3	0.3	0.3	0.3	0.3	0.3	0.3	0.3		
Subtotal			2.4	2.9	3.4	3.9	3.1	3.4	3.9	3.4	3.4	2.9	2.9	2.1	38	
Total			11.0	18.8	22.4	23.1	21.4	18.9	19.4	16.8	16.6	13.6	7.6	7.5	197	

- In average ~16 FTE / per year > Upgrade I contribution (~13 FTE)
- Mandatory to reinforce technical staffs at CPPM, IJCLab, LPNHE (retirement, NOEMI, ...)

Preliminary R&D and Core budgets

update with respect to IN2P3 LOI

► R&D : 730 k€

R&D	Run 3				LS 3			Run 4			LS 4	
	22	23	24	25	26	27	28	29	30	31	32	33
ECAL	50		90					60				
UT	105		105									
PCIe400	47	49	13			47	49	13				
RTA	50							50				
Total	137	139	123	110	-	47	49	60	47	17	-	-

► CORE : 5 345 k€

CORE	Run 3				LS 3			Run 4			LS 4	
	22	23	24	25	26	27	28	29	30	31	32	33
ECAL					500					2 000		
UT					60	60	60	570	670	720		
PCIe400				105	210				105	210		
RTA												
Total	-	-	75	105	520	310	60	570	775	2 930	-	-

Preliminary total budget

CORE Upgrade II	135 MCHF
Common Fund Upgrade II	40 MCHF
Authors IN2P3	7 %
Exchange rate CHF / €	1

► From project estimates:

CORE	5 350 k€
Safety margin (20 %)	1 070 k€
Common Fund	2 800 k€
Total	9 220 k€

► Fare share:

12 250 k€

- Order of magnitude for the total cost varies between 9 and 12 M€
+ R&D + Construction CDD + M&O + Computing LCG France

Laboratory's Scientific Council...

Feedback from laboratory's Scientific Council

IJCLab	Dec 22	<ul style="list-style-type: none">• Opinions are very positive• Recommend a very strong support in technical staff
LLR	Jun 22	<ul style="list-style-type: none">• Support the participation in UT Upgrade II• Proposed contribution in electronics is relevant
LPNHE	Nov 21	<ul style="list-style-type: none">• Encourage R&D on UT and RTA
Subatech	Mar 22	<ul style="list-style-type: none">• Note the relevance of the group's expertise in MFT for UT• Stress difficulties of participation to ALICE / Run 4 and to prepare LHCb Upgrade II in parallel

- ▶ Overall, support of proposals or encouragement to pursue R&D
- ▶ In most cases, project boundaries have to be better defined
- ▶ Difficulties for ALICE collaborators to harvest physics results within ALICE collaboration and to prepare the LHCb Upgrade II in parallel

Conclusions

- ▶ Le programme de la physique des saveurs est inscrit dans les plans du CERN et devrait acquérir des données jusqu'à la fin 2041
- ▶ Après plus de 25 ans, la communauté LHCb France est très engagée dans la collaboration LHCb. Elle est très attachée à extraire de la physique de qualité en utilisant tout le potentiel du LHC Haute luminosité et du futur détecteur LHCb Upgrade II
- ▶ LHCb Upgrade II est une opportunité pour l'institut afin de pousser l'état des connaissances dans des technologies clés comme les mesures temporelles à 10 ps, l'acquisition de très gros volumes de données et leur traitement en parallèle sur des architectures hétérogènes du type CPU + GPU, ...

Il prépare aussi la nouvelle génération d'ingénieurs et de physiciens à concevoir, construire et exploiter des détecteurs complexes dans des environnements difficiles

- ▶ Ce projet très ambitieux arrive dans une nouvelle phase dans laquelle il va falloir lui donner sa forme finale. Elle dépendra de possibles avancés en R&D, mais surtout des moyens humains et financiers que chaque pays est prêt à y consacrer. Nous espérons que nous nous y engagerons à la hauteur de nos expertises et des efforts déjà consentis

Conclusions (UK version)

- ▶ The flavour physics program is part of CERN's plans and should acquire data until the end of 2041
- ▶ After more than 25 years, the LHCb France community is very committed to the LHCb collaboration. It is very devoted extracting quality physics by using the full potential of the high luminosity LHC and the future LHCb Upgrade II detector.
- ▶ LHCb Upgrade II is an opportunity for IN2P3 to push the state of the art in key technologies such as 10 ps time measurements, acquisition of very large volumes of data and their parallel processing on heterogeneous architectures such as CPU + GPU, ...

It also prepares the next generation of engineers and physicists to design, build and operate complex detectors in challenging environments

- ▶ This very ambitious project is entering a new phase in which it will have to define its final shape. The latter will depend on possible advances in R&D, but above all on the human and financial resources that each country is willing to devote to it. We hope that we will commit ourselves to it to the extent of our expertise and efforts already made.

Backup...

Planning R&T ECAL 2 (Spider ASIC)

PLANNING ASIC and TESTS LHCb_ECAL2	R&T IN2P3											
	2022				2023				2024			
	T1	T2	T3	T4	T1	T2	T3	T4	T1	T2	T3	T4
ASIC modelling												
Behavioral description												
Analog and mixed design and layout												
Channel time (IJCLab et Michau)												
Analog memory												
Bank of analog memory												
Discriminator												
PLL												
SLVS Emitter and Receiver												
Bandgap												
Ramp ADC												
Calibration DAC												
DLL												
Channel Energy (Barcelone)												
Preamp on PMT base with clipping / filtering												
Input stage												
Shaper												
T/H												
ADC 12 bits												
Digital design and layout (Michau)												
Slow control												
Serialiser												
Memory management												
Top Design and layout top (IJCLab, Barcelone, Michau)												
Basic building blocks												
One channel V1												
One channel V2												
Multi channel												
Multi channel pre-production												
Multi channel production												
Verification												
UVM Testbench												
Asic tests												
Basic building blocks												
One channel V1												

Planning R&T PCIe400

