

université
PARIS-SACLAY

cea

De la recherche à l'industrie

 **Irfu - CEA Saclay**
Institut de recherche
sur les lois fondamentales
de l'Univers

Des particules cosmiques pour étudier les pyramides et les volcans

David ATTIE
&

Maxence VANDENBROUCKE

Collège Milleroches, *Saint-André*

- Le CEA et ses missions
- La physique des particules
- Détecteurs de physique fondamentale
- La tomographie muonique
- WatTo, expérience décisive
- ScanPyramids: préparation de la mission et découvertes
- Conclusions

- Né à Sainte-Clotilde (Réunion)
 - Baccalauréat C au lycée Lecomte-de-Lisle
 - Université Paris VI
 - Doctorat d'astrophysique (CEA)
 - Embauché au CEA depuis 2008
- Spécialité : trajectographie, tomographie muonique
- Né en Seine Saint-Denis (région parisienne)
 - Baccalauréat S au lycée Sainte-Genviève (Meaux)
 - Ecole d'ingénieur ESIEE puis M2 CMI
 - Doctorat de physique des particules (TUM/CEA)
 - Embauché au CEA depuis 2016
- Spécialité : détecteur pour la physique nucléaire



- Commissariat à l'Énergie atomique et aux Énergies alternatives



**Défense et
sécurité
du pays**

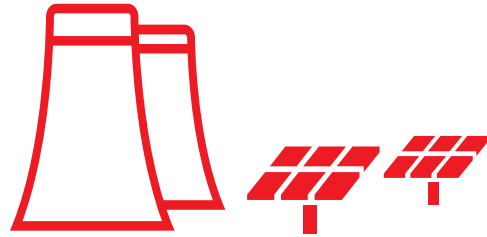

**Énergies
Nucléaire et
renouvelables**

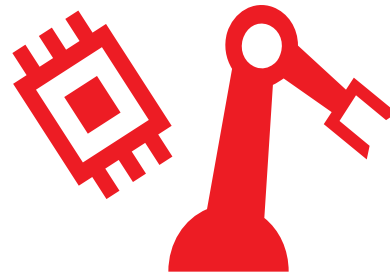

**Recherche
technologique
pour l'industrie**

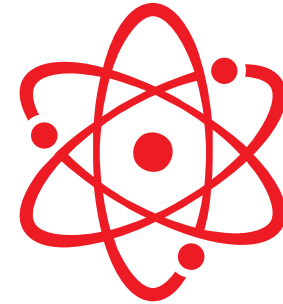

**Recherche
fondamentale**

- Créé le 18 octobre 1945 par Charles de Gaulle
- Organisme public de recherche scientifique
- Classé en établissement public à caractère industriel et commercial (EPIC)

15 958 techniciens, ingénieurs, chercheurs et collaborateurs sur 10 centres

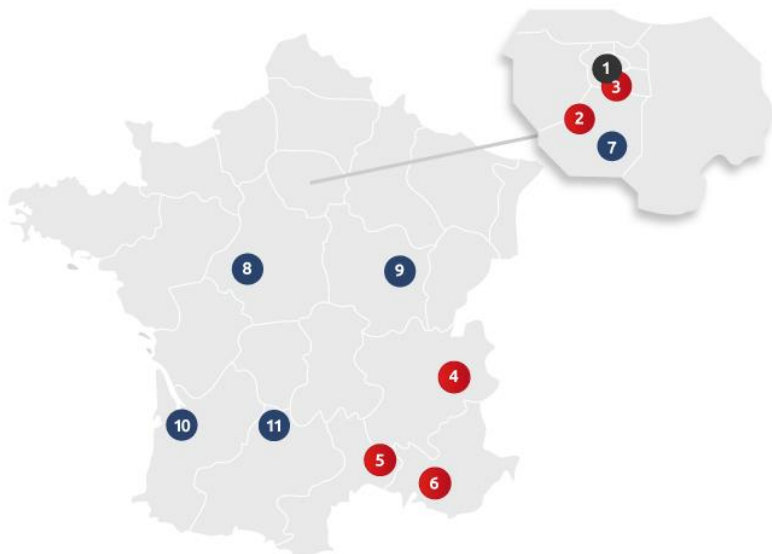

1 SIÈGE SOCIAL

CENTRES D'ÉTUDE CIVILS

- 2 Saclay
SIÈGE ADMINISTRATIF
- 3 Fontenay-aux Roses
- 4 Grenoble
- 5 Marcoule
- 6 Cadarache

CENTRES POUR LES APPLICATIONS MILITAIRES

- 7 DAM Ile-de-France
- 8 Le Ripault
- 9 Valduc
- 10 Cesta
- 11 Gramat

CEA
16000 personnes, 4 pôles

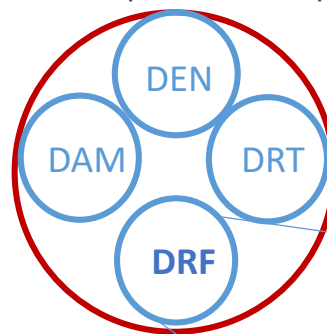

DRF
~7000 personnes, 11 instituts et labos

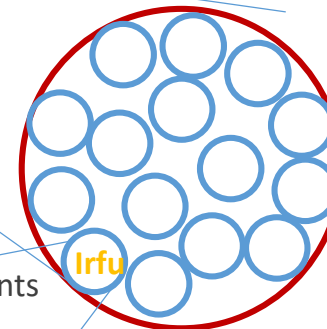

Irfu
~1000 personnes, 7 départements

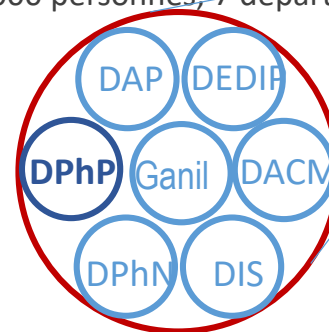

Institut de Recherche sur les lois Fondamentales de l'Univers

Département d'Electronique, des Détecteurs et d'Informatique pour la Physique

- De quoi c'est composé et à quoi ça sert ?
- Métier de physicien : comprendre la matière..

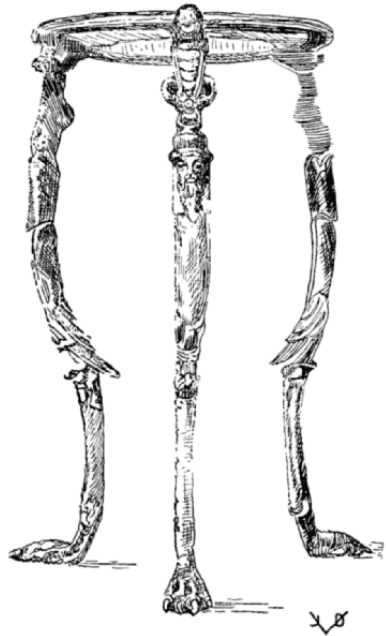

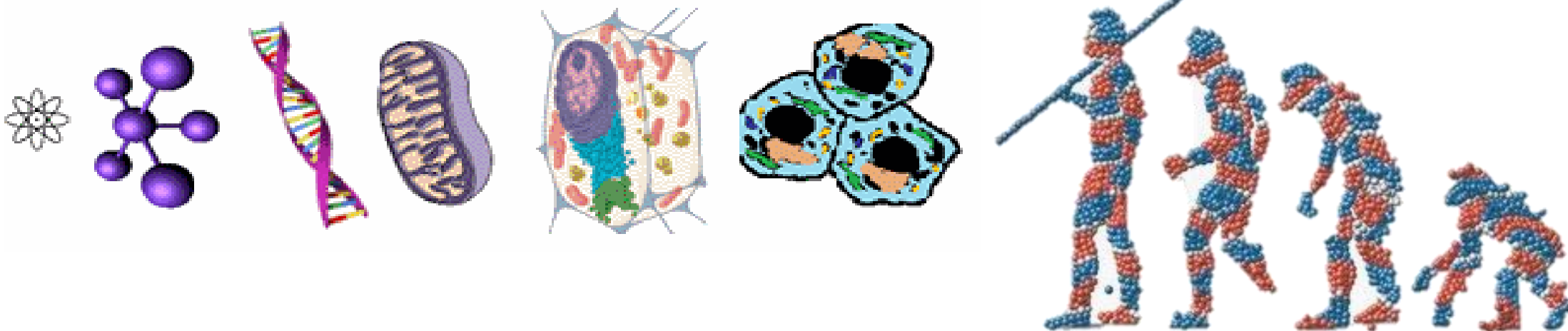
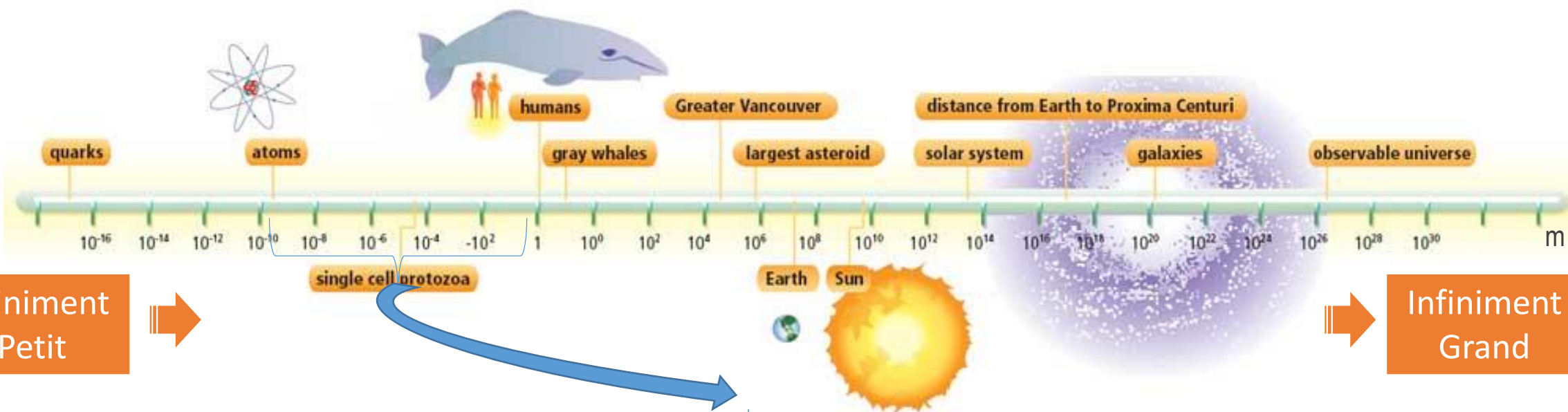

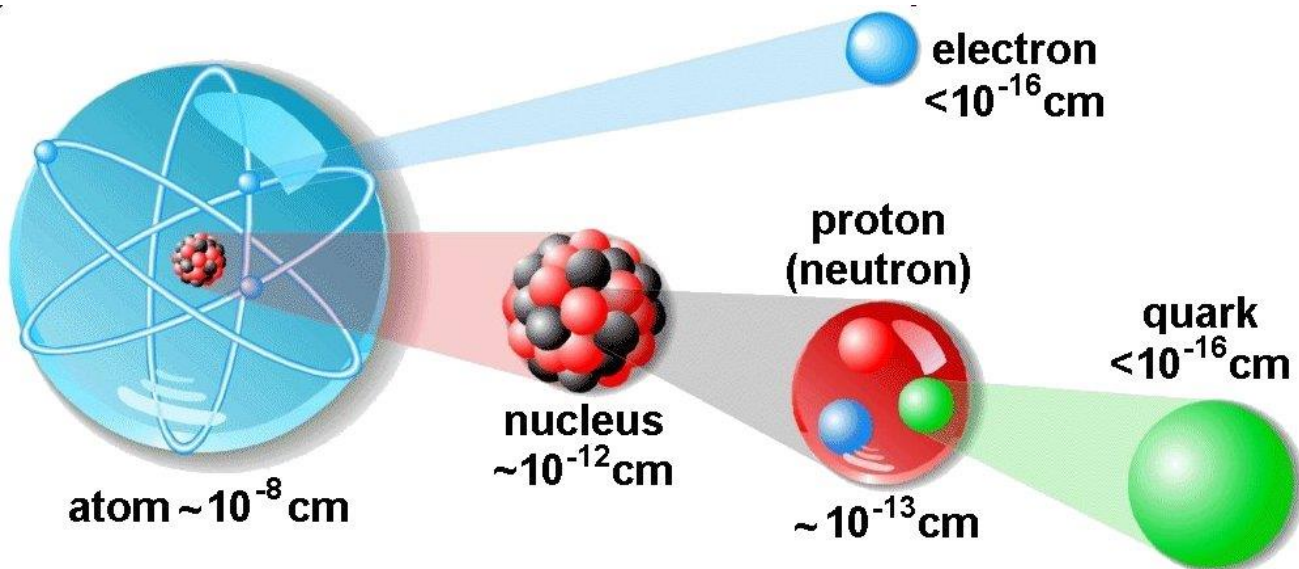

mass \rightarrow	$\approx 2.3 \text{ MeV}/c^2$	$\approx 1.275 \text{ GeV}/c^2$	$\approx 173.07 \text{ GeV}/c^2$	0	$\approx 126 \text{ GeV}/c^2$
charge \rightarrow	$2/3$	$2/3$	$2/3$	0	0
spin \rightarrow	$1/2$	$1/2$	$1/2$	1	0
	u up	c charm	t top	g gluon	H Higgs boson
QUARKS	$\approx 4.8 \text{ MeV}/c^2$	$\approx 95 \text{ MeV}/c^2$	$\approx 4.18 \text{ GeV}/c^2$	0	
	$-1/3$	$-1/3$	$-1/3$	0	
	$1/2$	$1/2$	$1/2$	1	
	d down	s strange	b bottom	γ photon	
	$0.511 \text{ MeV}/c^2$	$105.7 \text{ MeV}/c^2$	$1.777 \text{ GeV}/c^2$	$91.2 \text{ GeV}/c^2$	
	-1	-1	-1	0	
	$1/2$	$1/2$	$1/2$	1	
	e electron	μ muon	τ tau	Z Z boson	
LEPTONS	$< 2.2 \text{ eV}/c^2$	$< 0.17 \text{ MeV}/c^2$	$< 15.5 \text{ MeV}/c^2$	$80.4 \text{ GeV}/c^2$	
	0	0	0	± 1	
	$1/2$	$1/2$	$1/2$	1	
	ν_e electron neutrino	ν_μ muon neutrino	ν_τ tau neutrino	W W boson	
					GAUGE BOSONS

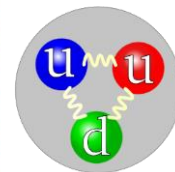

		HADRONS			QUARKS			LEPTONS			BOSONS DE JAUGE		
masse →		≈2.3 MeV/c ²	≈1.275 GeV/c ²	≈173.07 GeV/c ²	0	≈126 GeV/c ²							
charge →		2/3	2/3	2/3	0	0							
spin →		1/2	1/2	1/2	0	0							
		u up	c charm	t top	g gluon	H boson de Higgs							
		d down	s strange	b bottom	γ photon								
		e électron	μ muon	τ tau	Z⁰ boson Z ⁰								
		ν_e neutrino électronique	ν_μ neutrino muonique	ν_τ neutrino tauique	W[±] boson W [±]								

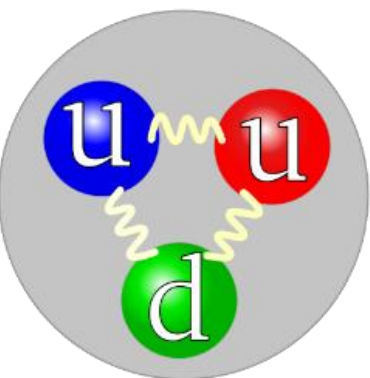

proton

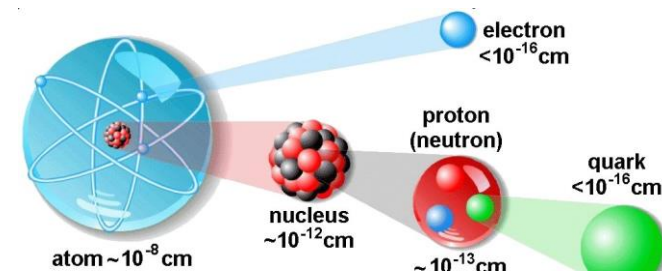

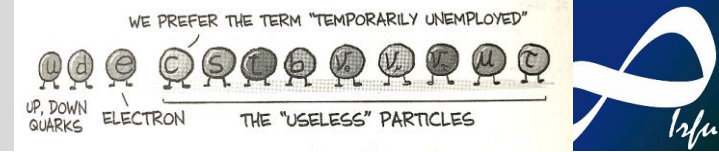

The Standard Model of particle physics

Years from concept to discovery

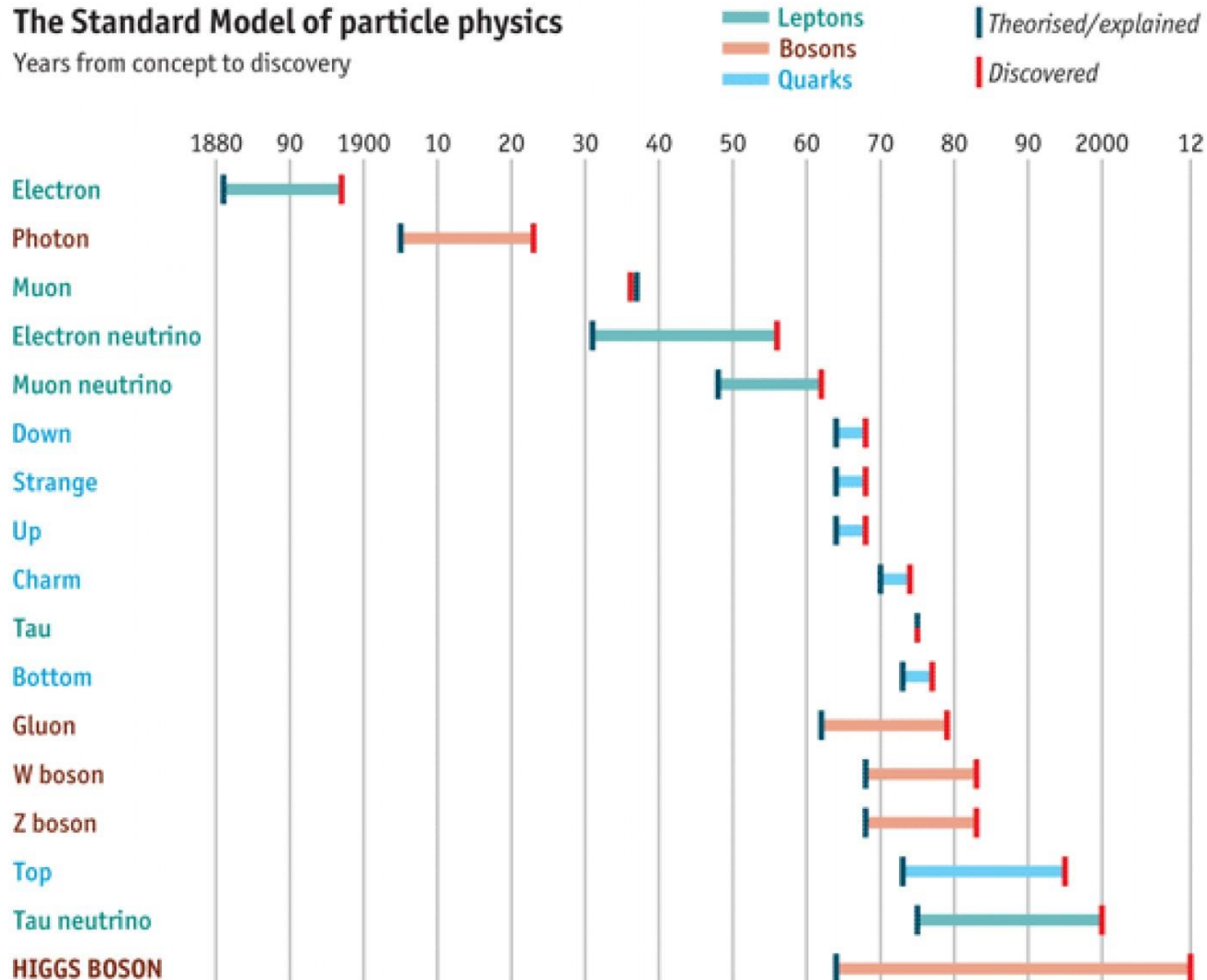

Source: *The Economist*

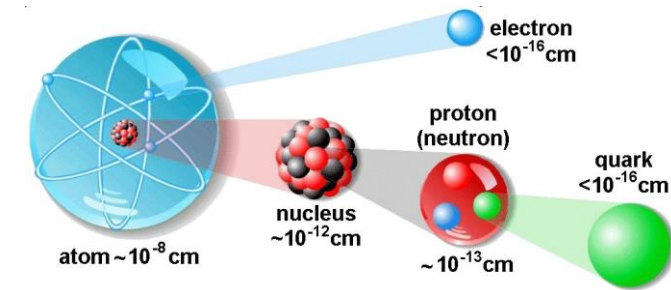
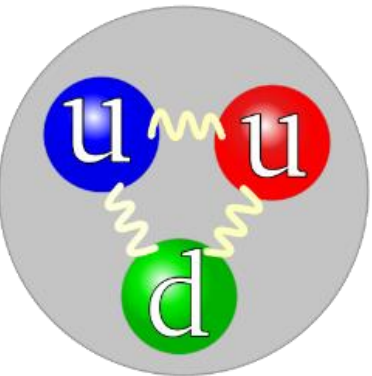

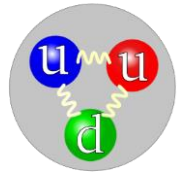

ponctuel

Quelle *taille* ?

Distant

Closer

Closer Still



$10^{-15}m$



Théorie quantique des champs

quark

anti quark

gluon

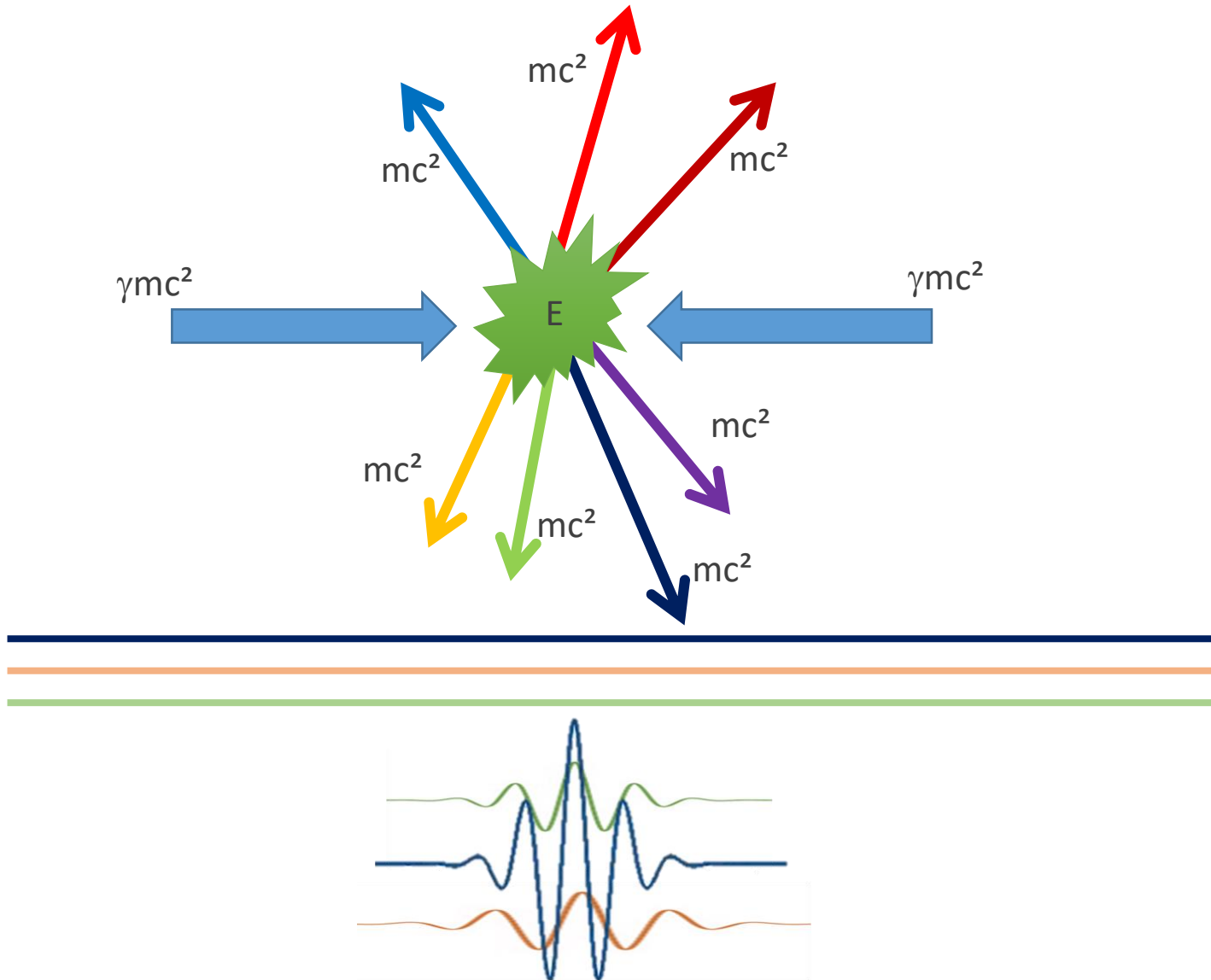
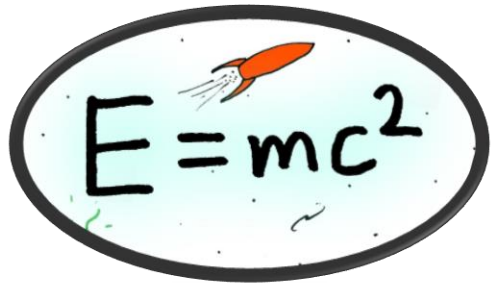

...il vous le rendra.

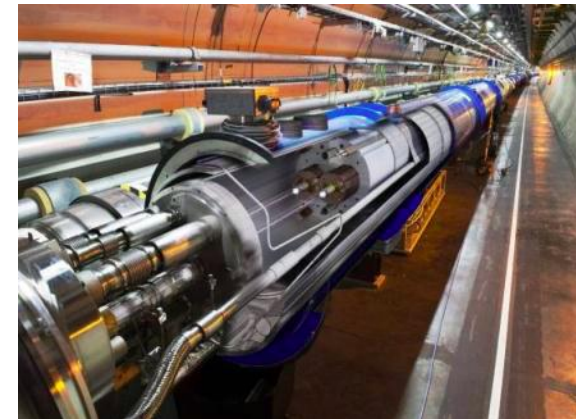

27 km
8.3 T
10⁻¹³ atm
1.9 K (**-271.3 °C**)
362 MJ

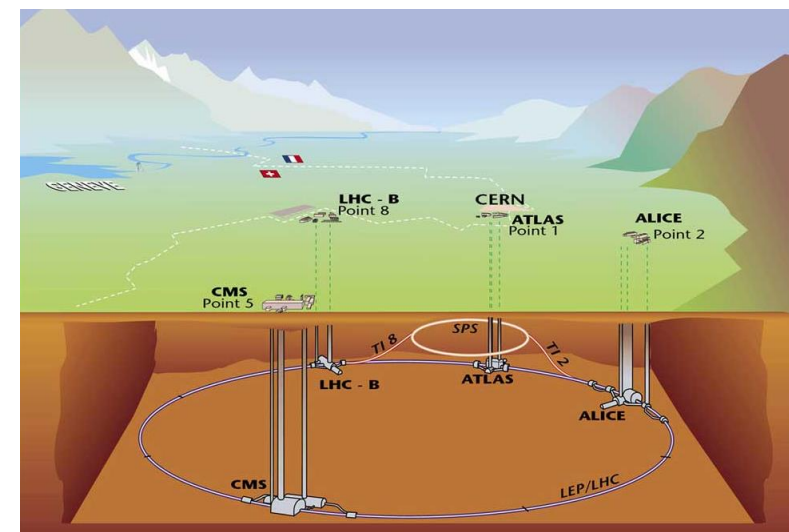



The LHC accelerator

Compact Muon Solenoid

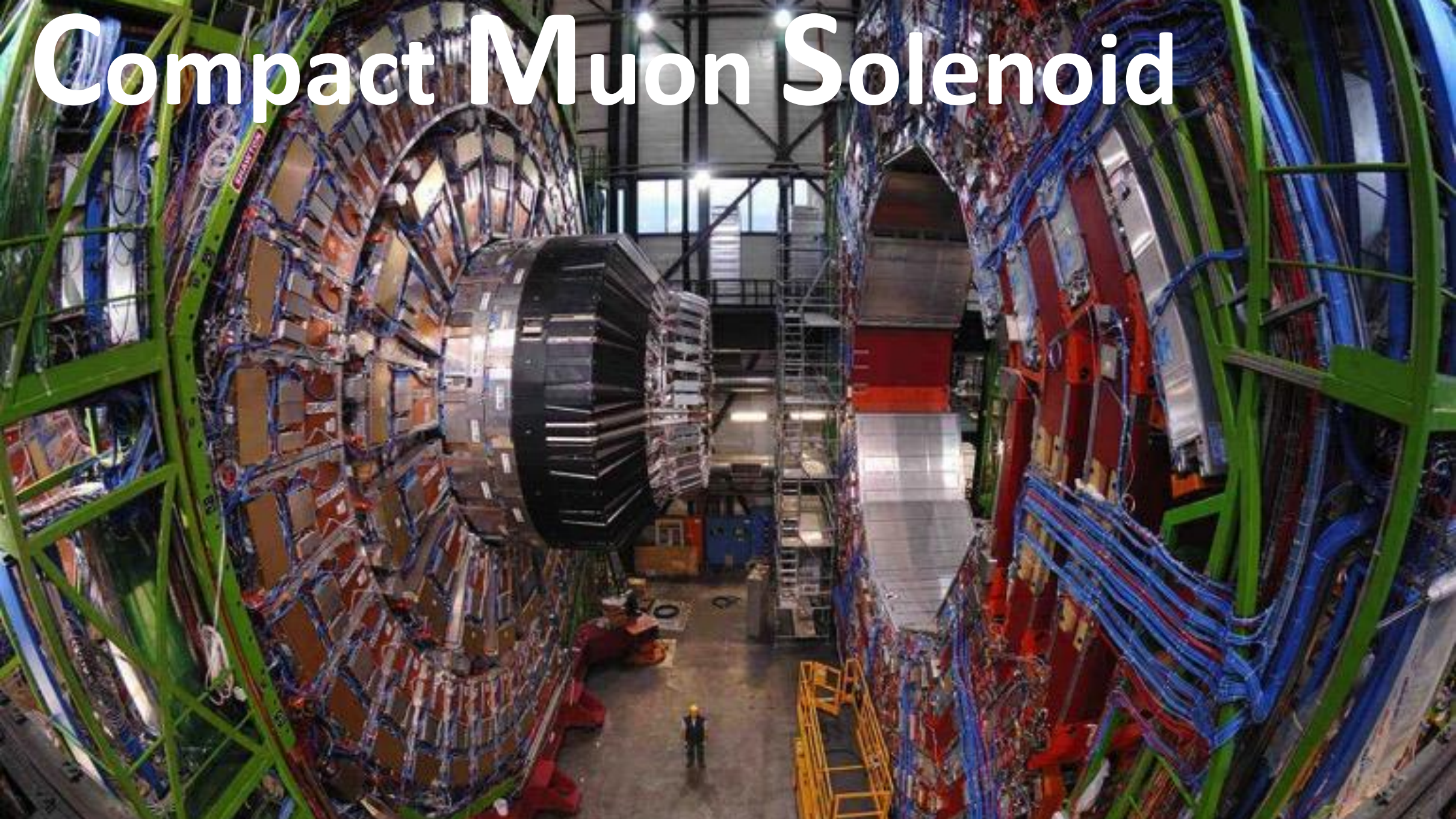

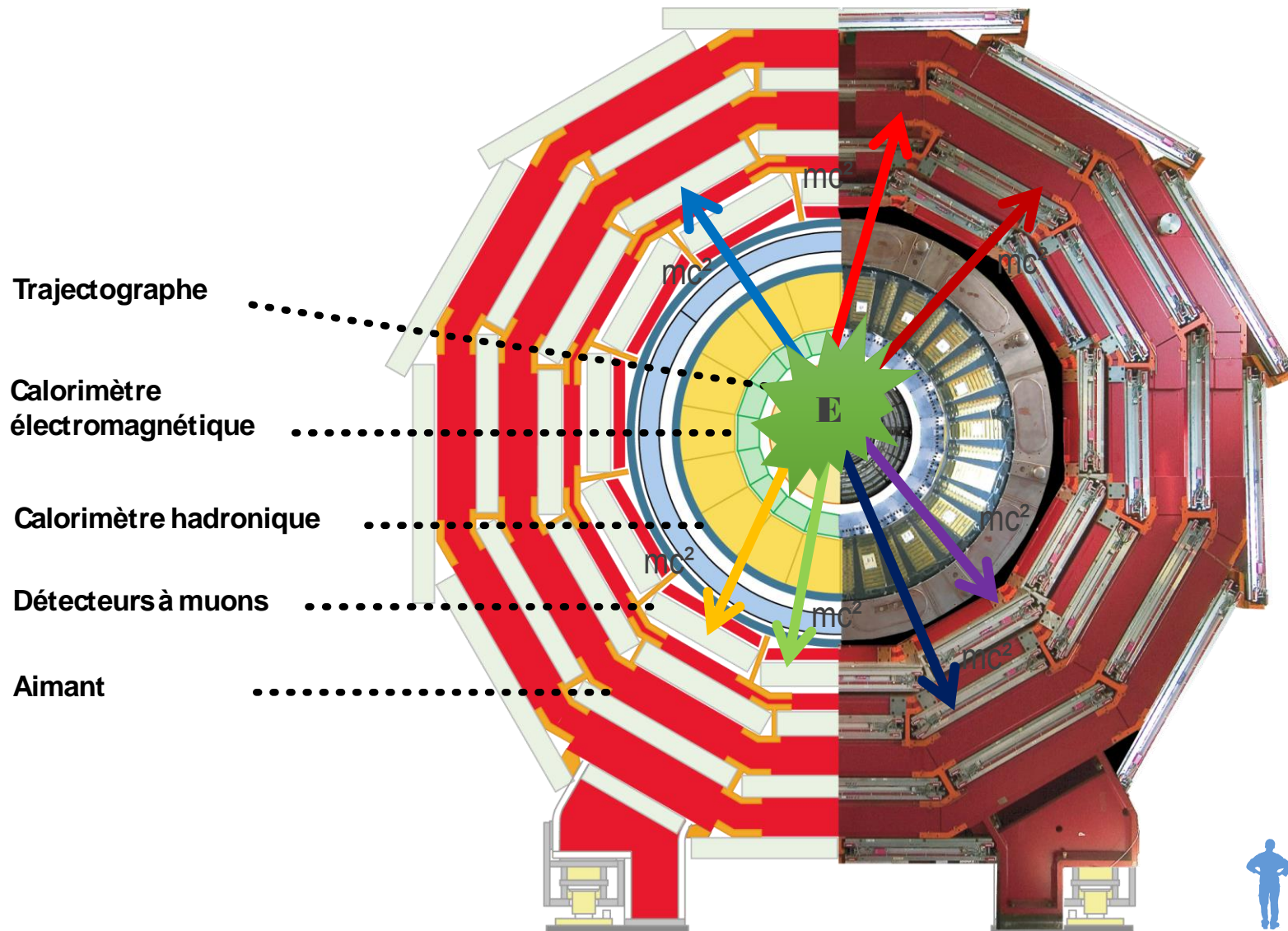

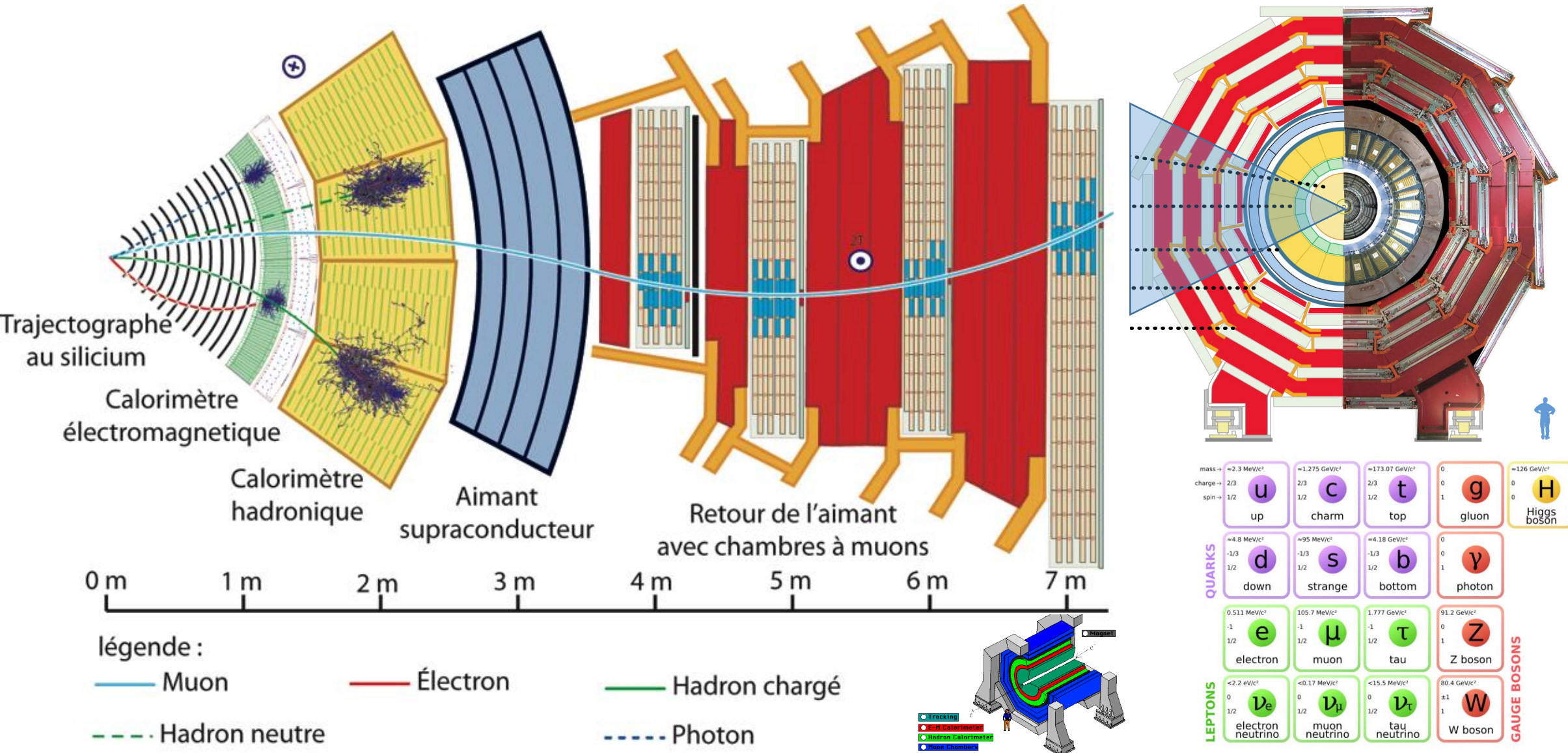

Et Paf !

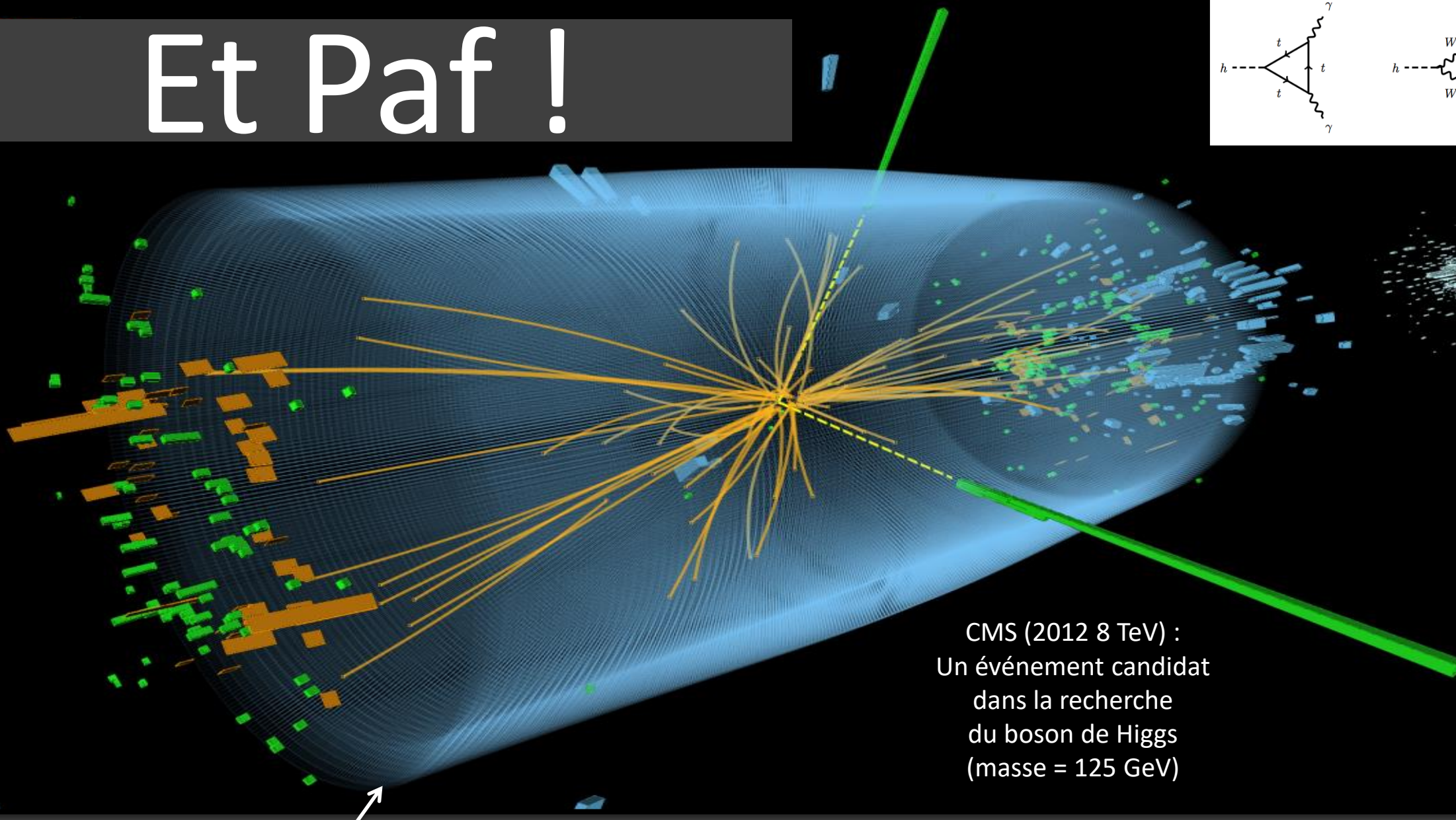
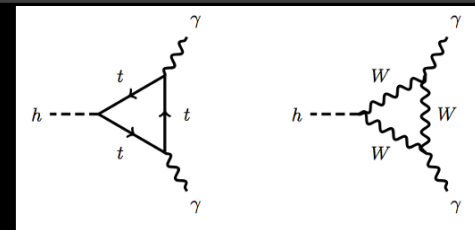

CMS (2012 8 TeV) :
Un événement candidat
dans la recherche
du boson de Higgs
(masse = 125 GeV)

Calorimètre électromagnétique

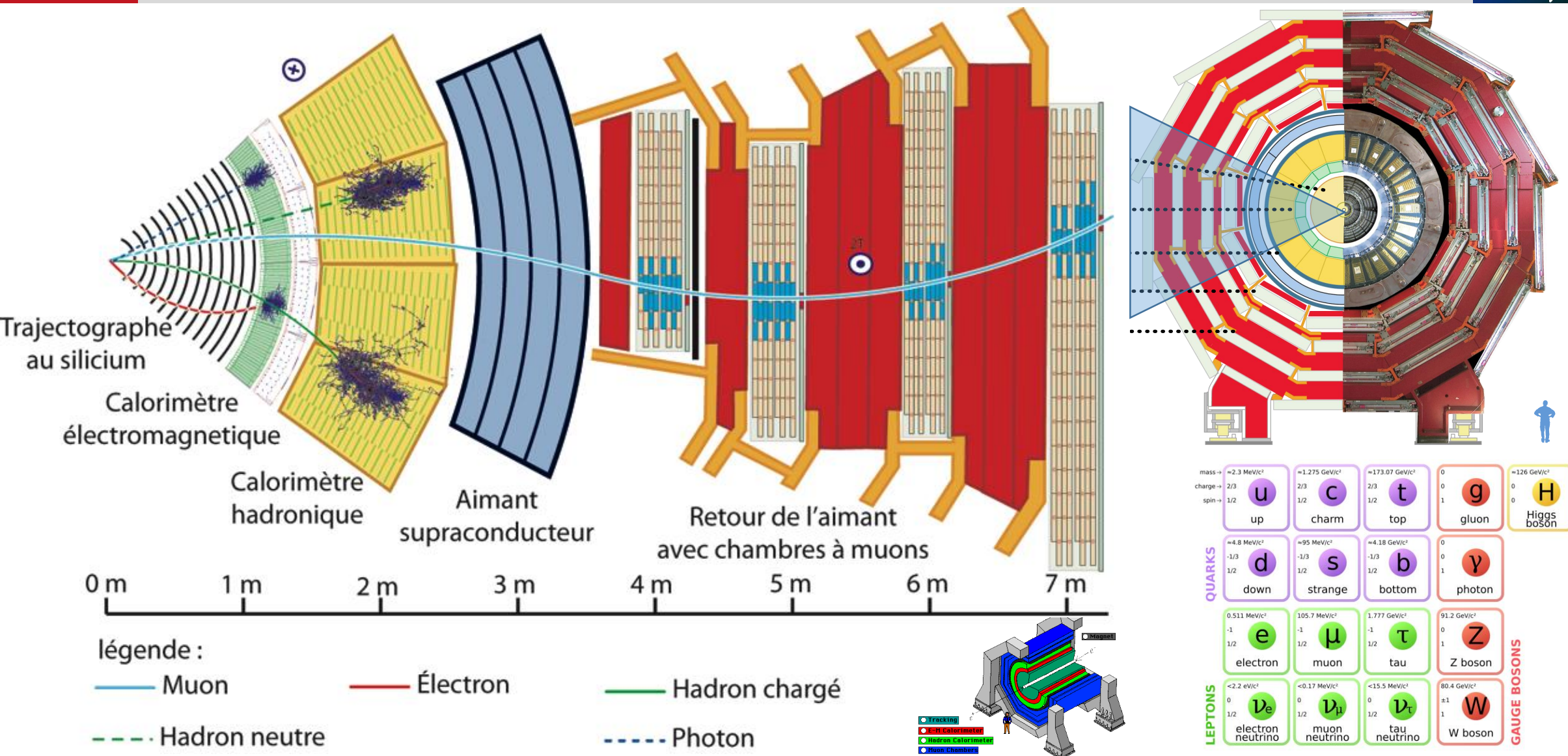



Trajectographe
au silicium

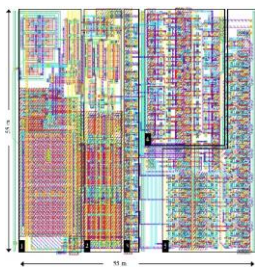
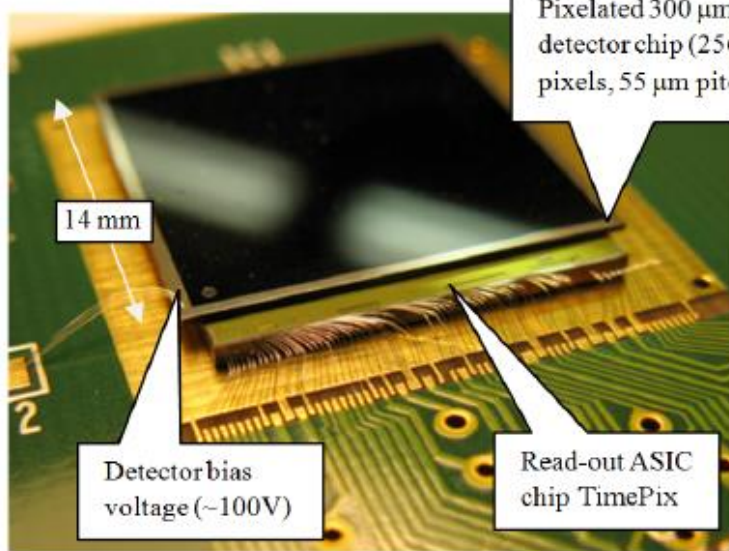
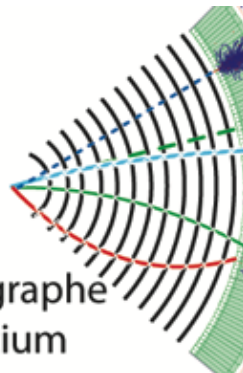

Sensor Material:	Si
Sensor Thickness:	300 μm and 500 μm
Sensitive Area:	14 mm x 14 mm
Number of Pixels:	256 x 256
Pixel Pitch:	55 μm
Resolution:	9 lp/mm
Readout Speed:	55 frames/s
Threshold Step Resolution:	0.1 keV
Energy Resolution:	0.8 keV (THL) and 2 keV (ToT)
Min Detectable Energy:	5 keV for X-rays
Photon Counting Speed:	up to 3×10^6 photons/s/pixel
Readout Chip:	Timepix
Pixel Mode of Operation:	Counting, Time-over-Threshold, Time- Arrival
Connectivity:	USB 2.0
Dimensions:	89 mm x 21 mm x 10 mm (L x W x H)
Weight:	30 g
Software:	Pixet PRO or ask for RadView radiatic visualization software

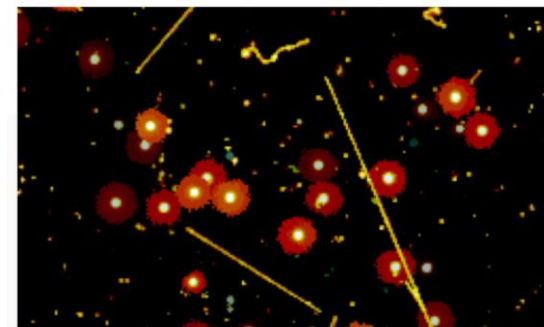
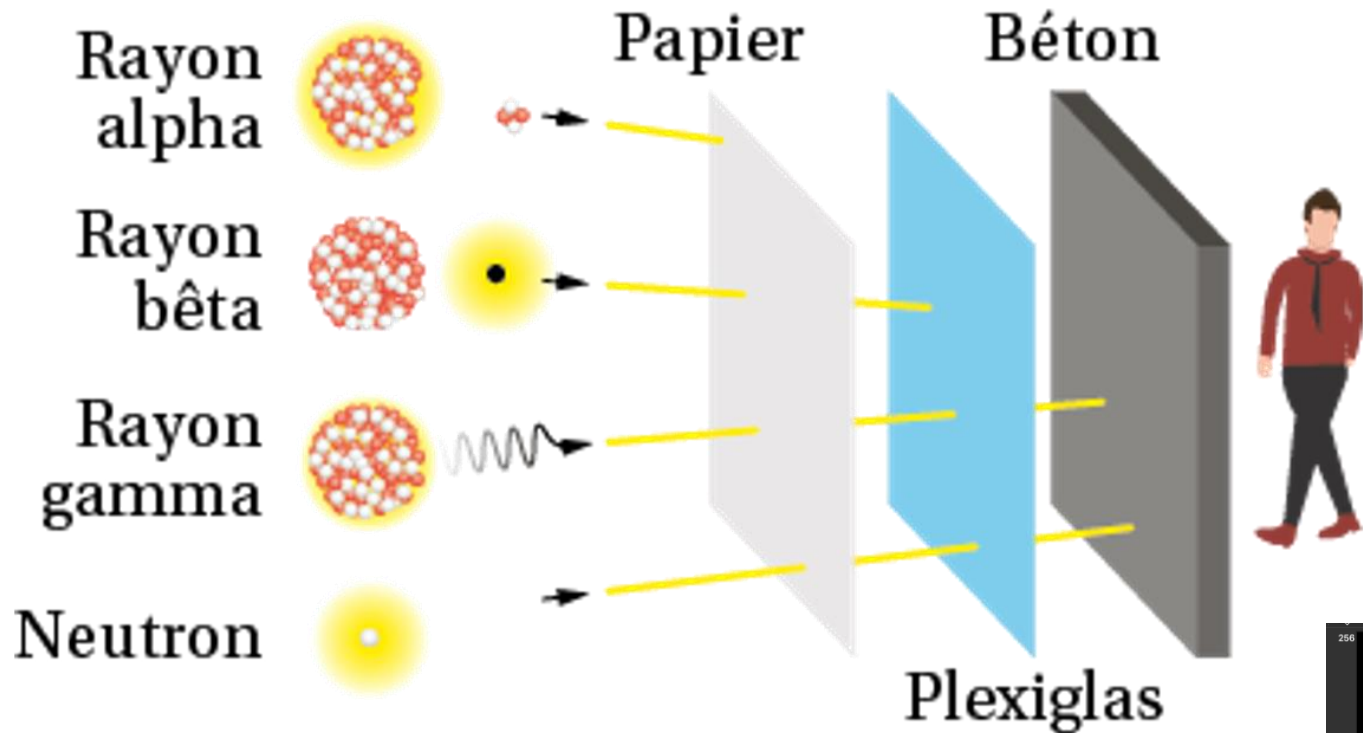

Muon

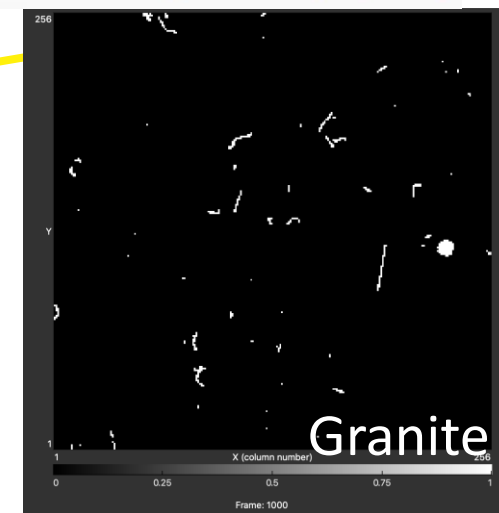
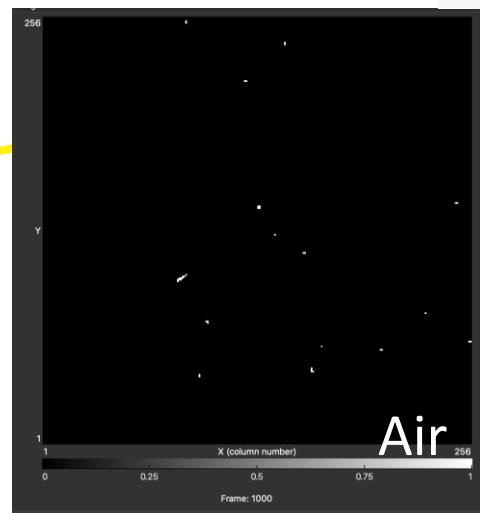
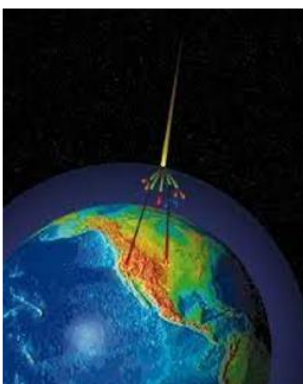

Radium-226 Decay Chain

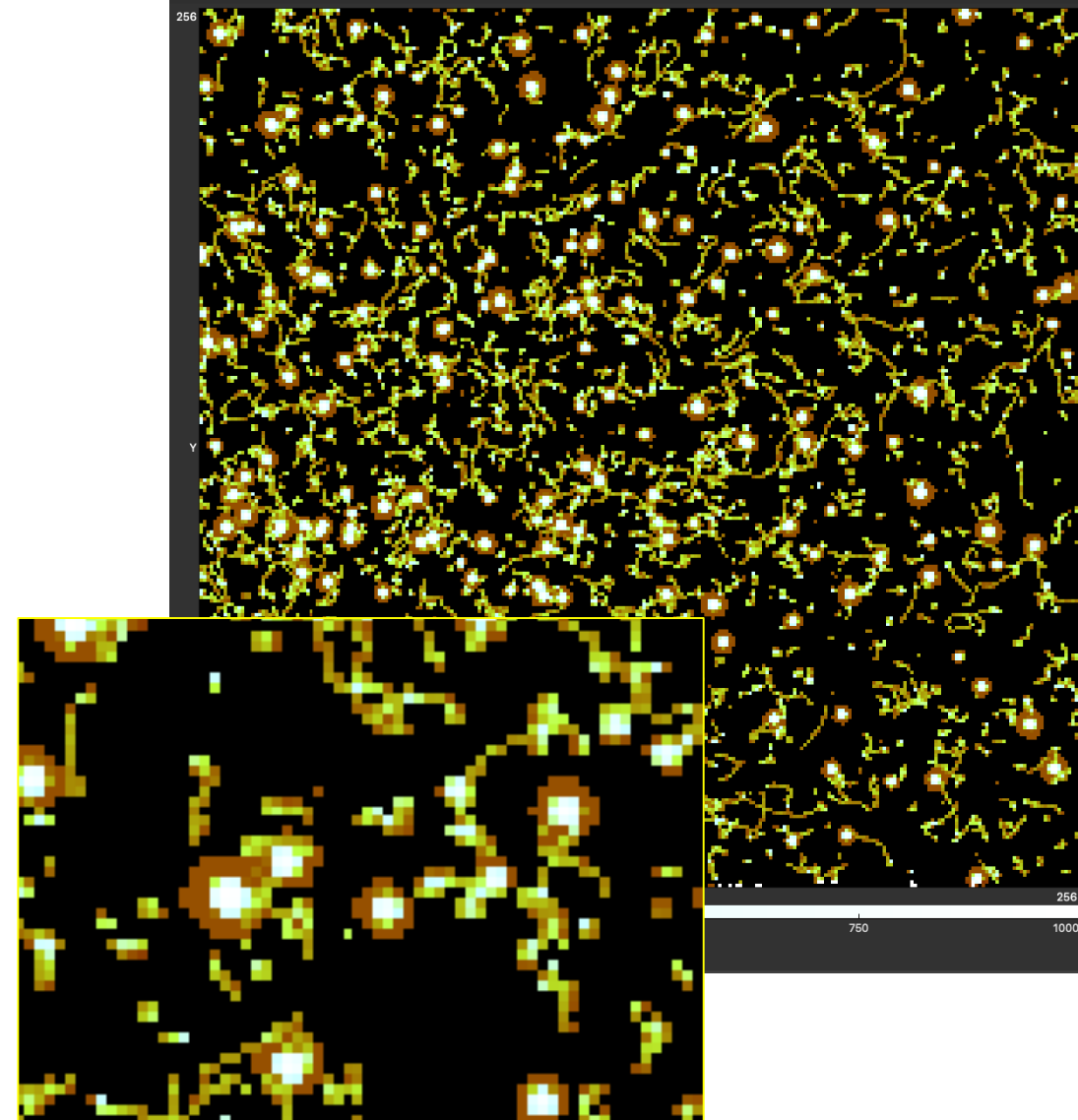
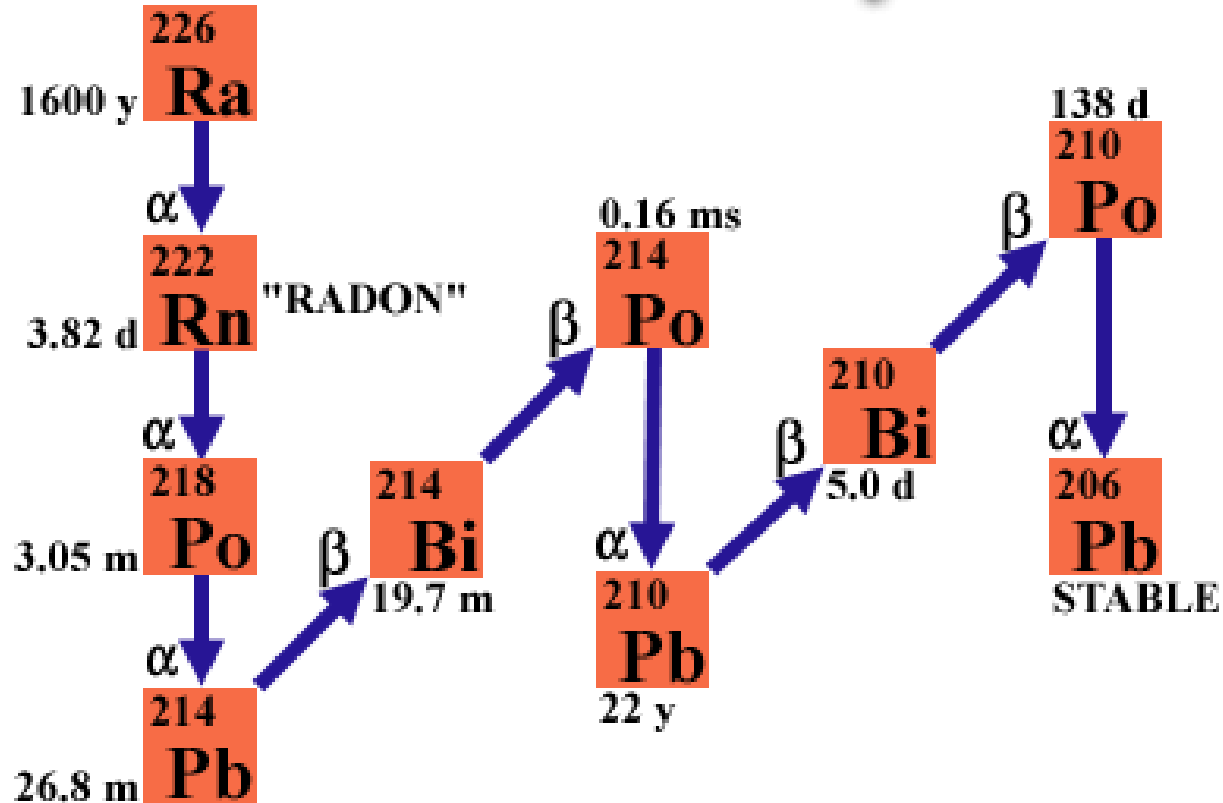

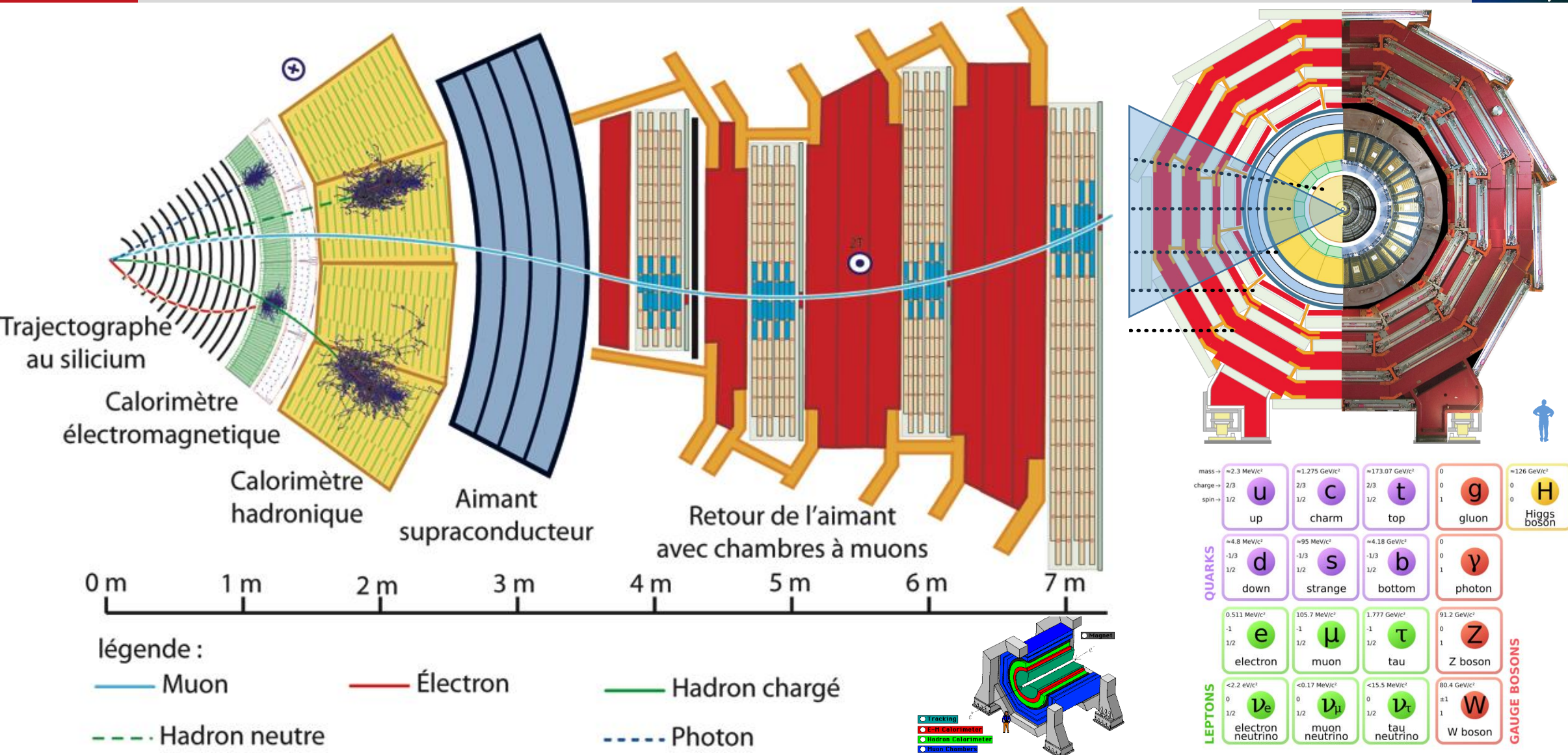



- Les muons sont issus des gerbes de particules issus de l'interaction du rayonnement cosmique dans la haute atmosphère
 - Flux : $\sim 150/\text{m}^2/\text{s} \sim \cos^2\theta$ (maximum au zénith)
 - Energie moyenne : 4 GeV (très pénétrant)
 - Durée de vie : $2 \mu\text{s}$
 - Naturel, gratuit et sans danger
 - Propagation rectiligne (en moyenne)
- Interaction du muon avec la matière

Materiau	Epaisseur	θ (°)	$P_{\text{absorption}}$
Air	100 m	0.094	0.78%
Plomb	10 cm	1.01	2.9%
Eau	1 m	0.35	4.2%
Roche	100 m		99%

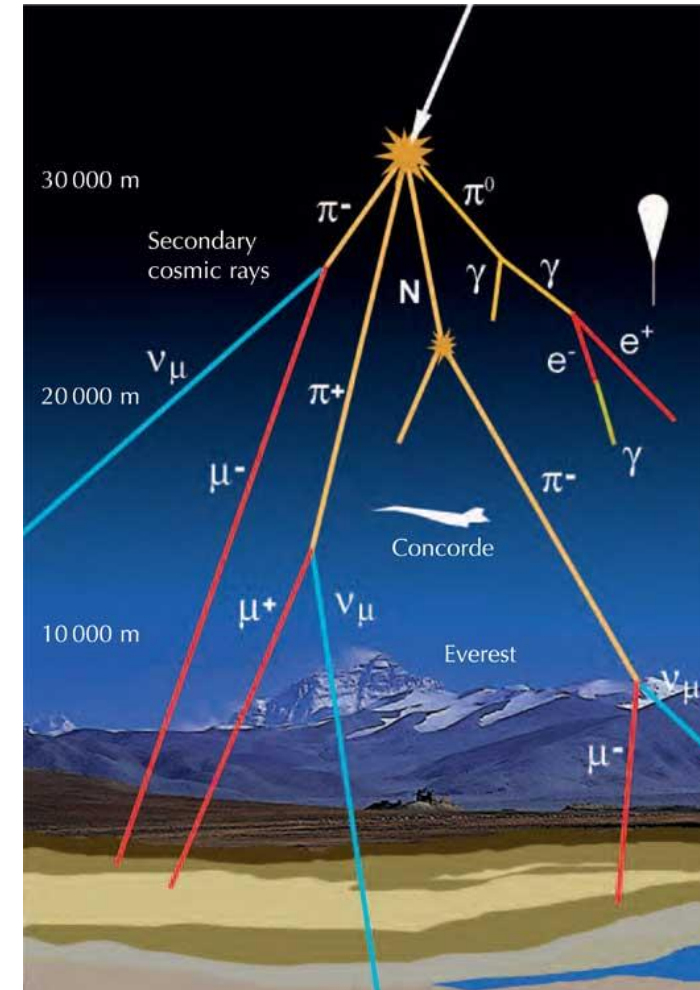
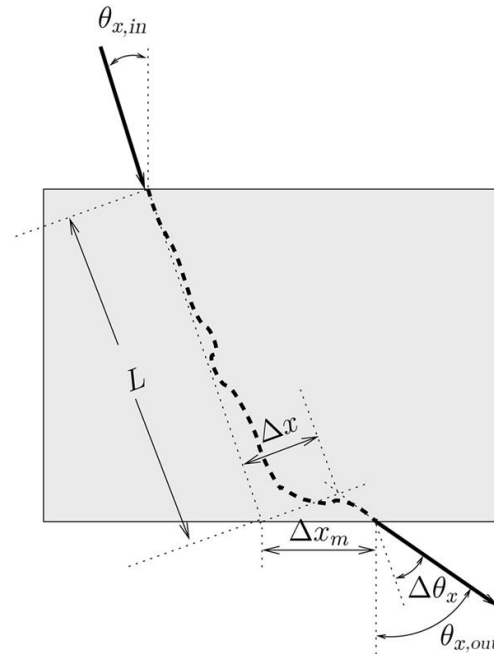

- Le rayonnement cosmique est composé de particules accélérées par des phénomènes violents dans l'Univers (H : 88% ; He: 9%)
 - Vent stellaire
 - Explosion d'étoiles
 - Noyaux actifs de galaxies
 - Environnement d'objets compacts
- L'interaction avec l'atmosphère provoque des gerbes de particules
 - gerbes électromagnétiques : γ , e^- & e^+
 - gerbes hadroniques : p , π & noyaux

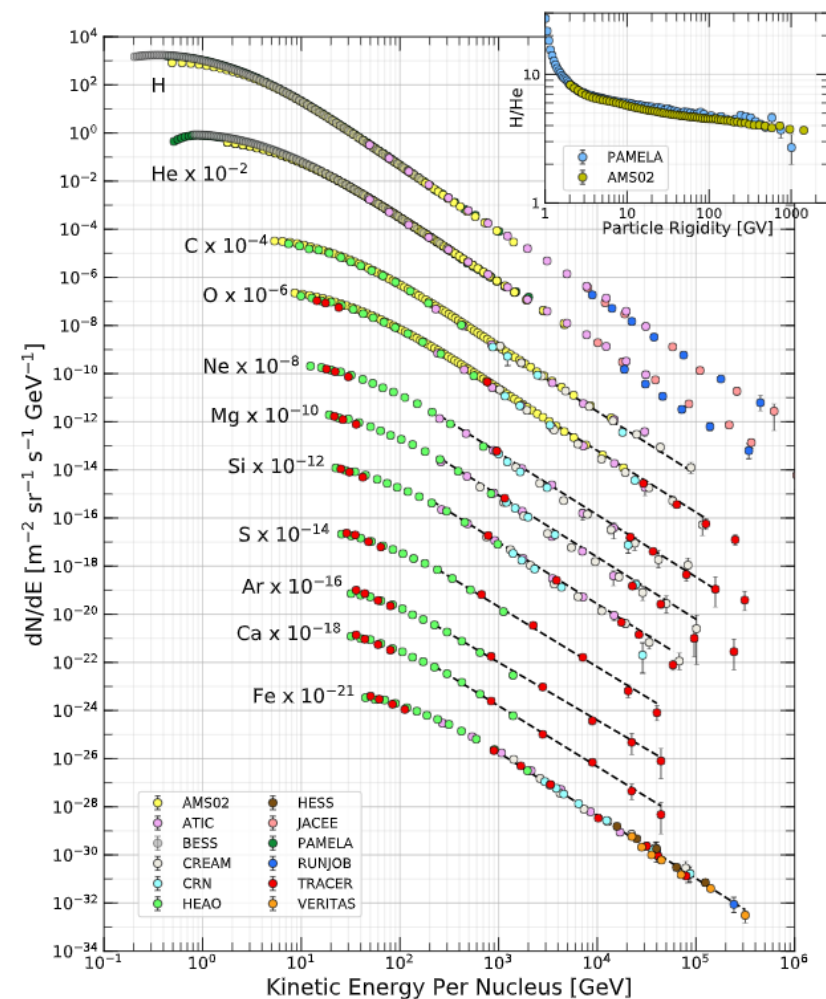
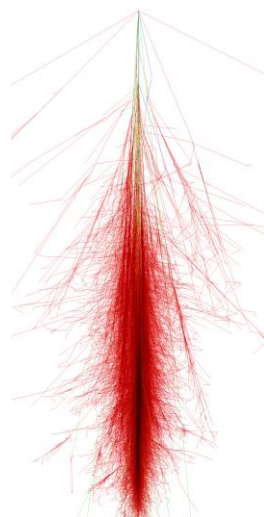

- Les muons peuvent
 - être arrêté (décroissance)
 - changer de trajectoire
- Le flux de muons donne donc une image du contraste de densité
- Il existe deux principaux mode de tomographie muonique
 - tomographie muonique par déviation
 - tomographie muonique par absorption

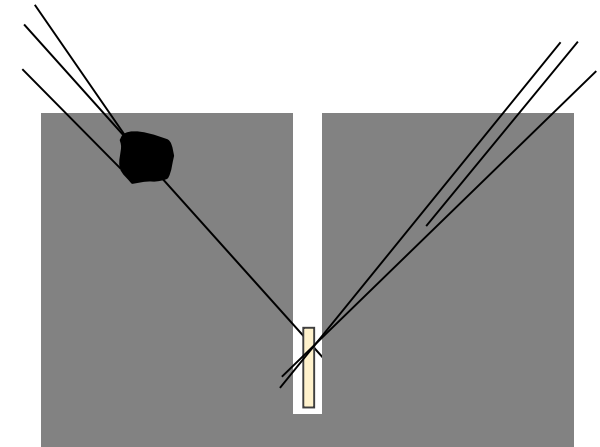
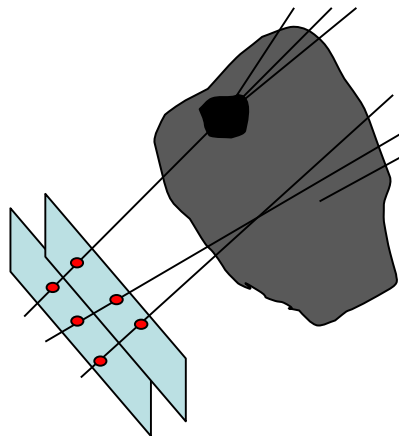
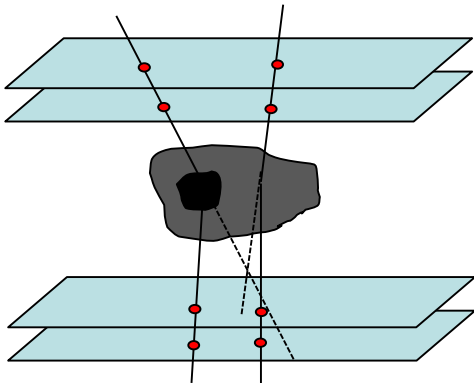



13 octobre 2014



11 mai 2015

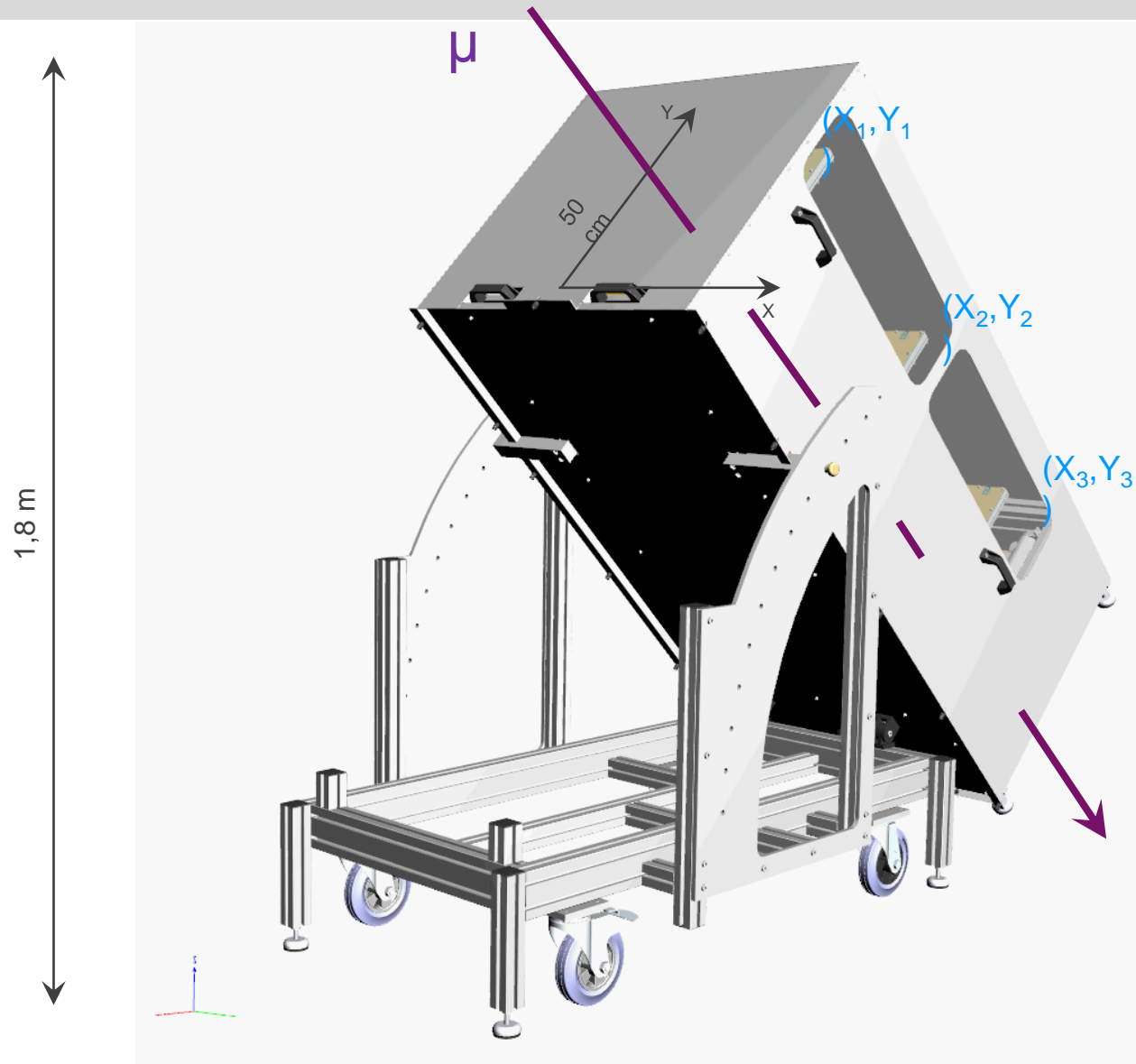

- Muographie statique :

- Temps de pose: 4 semaines (position 1)

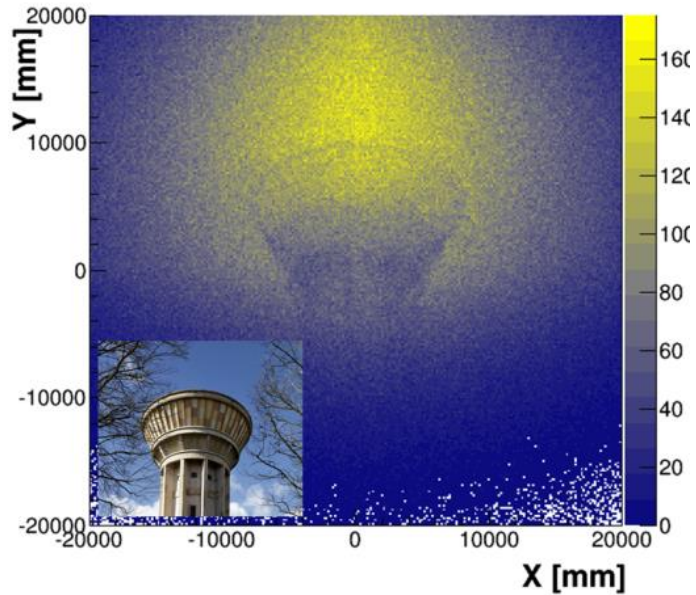

→ Première muographie « reconnaissable » d'une structure

Comment lire une muographie:

- Chaque pixel contient un nombre (ou flux) de muons reconstruits dans la direction correspondante
- Couleur claire → plus de muons → moins d'absorption → moins de matière
- Couleur sombre → moins de muons → plus d'absorption → plus de matière



- Muographie dynamique :

- Temps de pose: 4 jours (position 2)

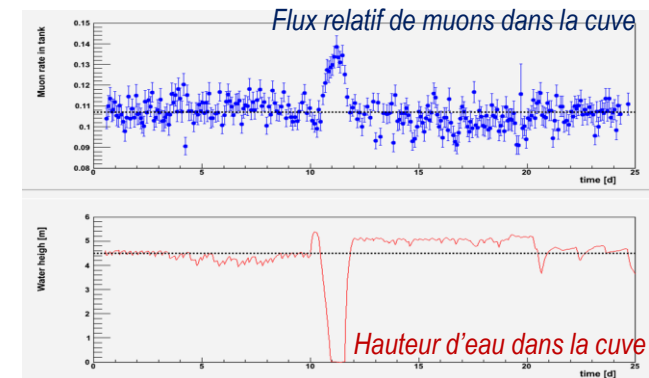
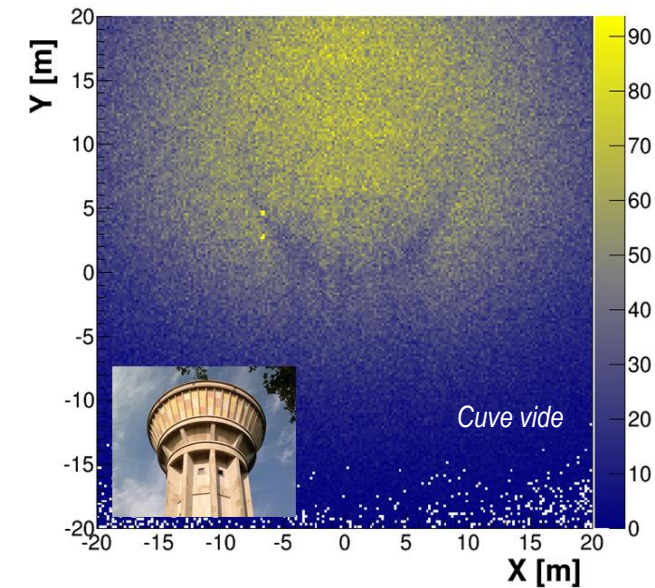
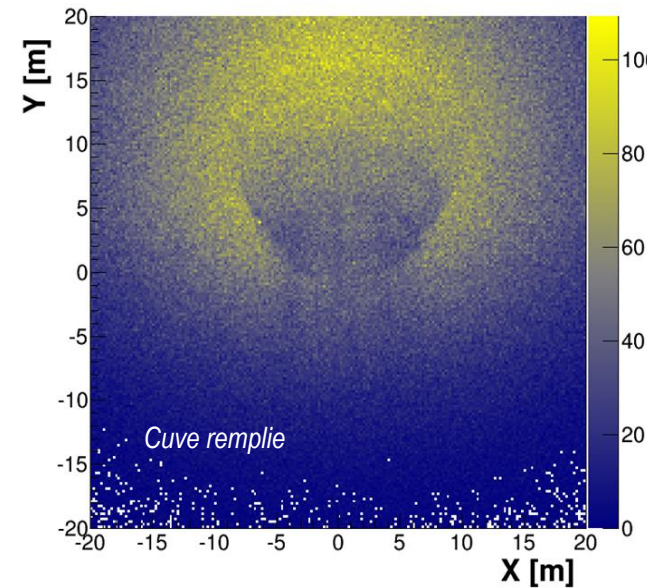

- **Collaboration internationale**
 - Coordonnée par l'Institut HIP (M. Tayoubi) et la faculté d'ingénierie du Caire (H. Helal)
 - Sous l'autorité du Ministère des Antiquités Egyptiennes
- **Objectif** : scanner les 4 grandes pyramides de la IV^{ème} dynastie

- Pyramide rhomboïdale
- Pyramide rouge
- Pyramide de Kheops
- Pyramide de Khephren

Dashour

Gizeh



**SCAN
PYRAMIDS**



HIP INSTITUTE
HERITAGE
INNOVATION
PRESERVATION



ARAB
REPUBLIC
OF EGYPT
MINISTRY OF
ANTIQUITIES



FACULTY OF
ENGINEERING
CAIRO
UNIVERSITY

- Plusieurs technologies “innovantes”:
 - Thermographie (faiblement pénétrant): Université de Laval
 - Muographie (très pénétrant): Nagoya, KEK, CEA
 - Drones (reconstruction de surfaces): Université du Caire
 - Photogrammétrie & modèles 3D: Emissive
 - + simulateur temps réel

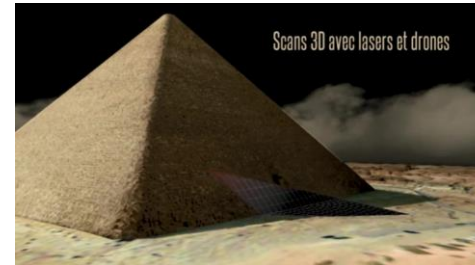
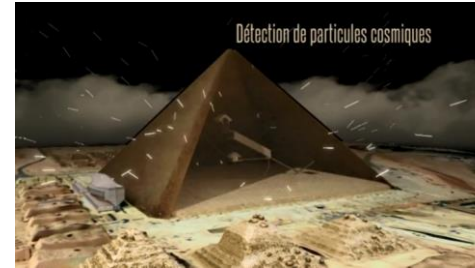
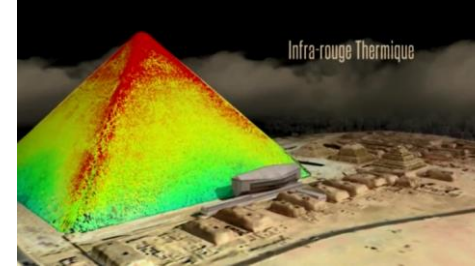

SCAN PYRAMIDS

HiP
HIP INSTITUTE
HERITAGE
INNOVATION
PRESERVATION

**ARAB
REPUBLIC
OF EGYPT
MINISTRY OF
ANTIQUEITIES**

**FACULTY OF
ENGINEERING
CAIRO
UNIVERSITY**

- Télescopes : 1 → 3
- Châssis → valise
- Détecteurs : prototype → série (industriel ELVIA-PCB)
- Durée de construction : 9 mois → 3 mois
- Poids : ~200 kg → ~130 kg
- Données : brutes → brutes + pré-analysées

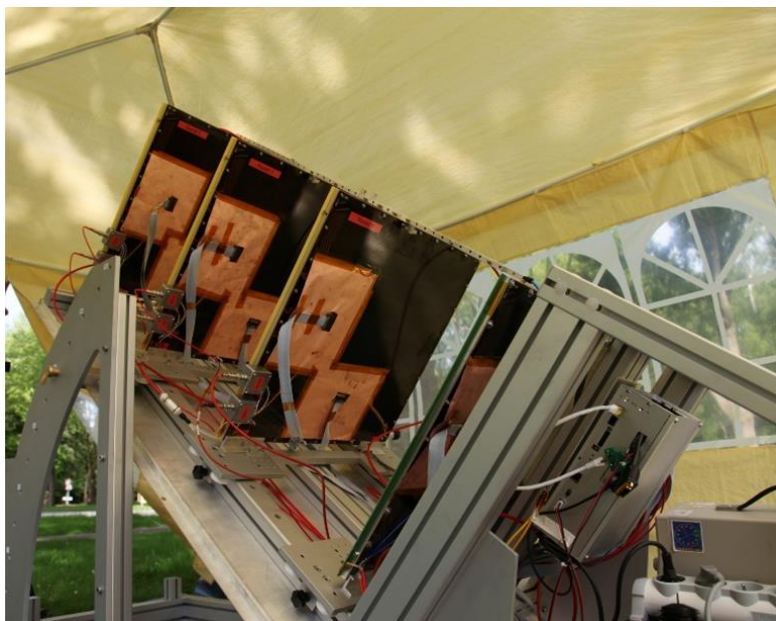

- Nouveaux télescopes
 - Plus transportable
 - Facilement opérationnel

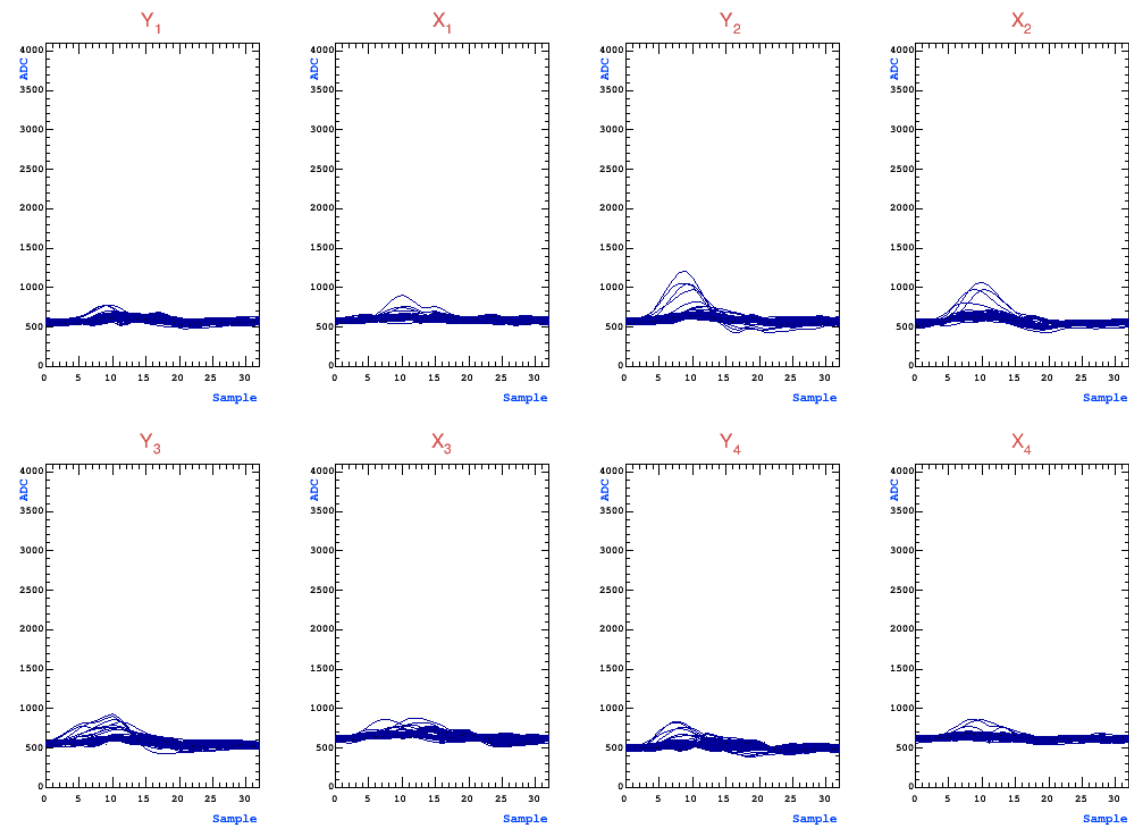
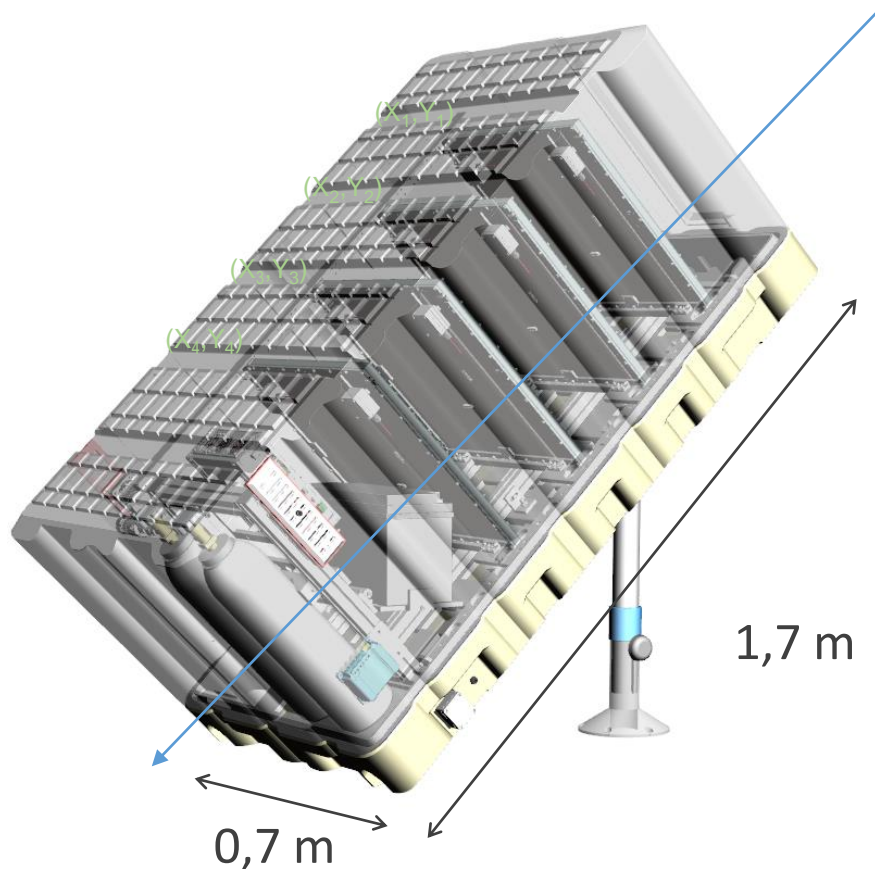

- Intégration en salle blanche des détecteurs
- Intégrations des télescopes et tests en extérieur
- 3 télescopes envoyés en avril 2016



Alhazen (n°1)

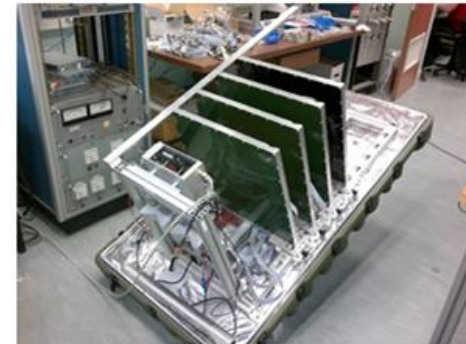

Alvarez (n°2)

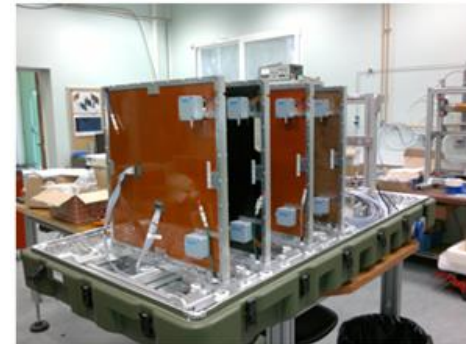

Brahic (n°3)



- Gardiennage obligatoire 24h/24, 7j/7
- Installation de tente nécessaire pour le gardien
- Communication via réseau 4G depuis la France



- Démonstration sur une cavité connue : arête nord-est
- Face Nord depuis l'extérieur visant le dessus de la grande Galerie
- Communication et contrôle via réseau 4G depuis la France

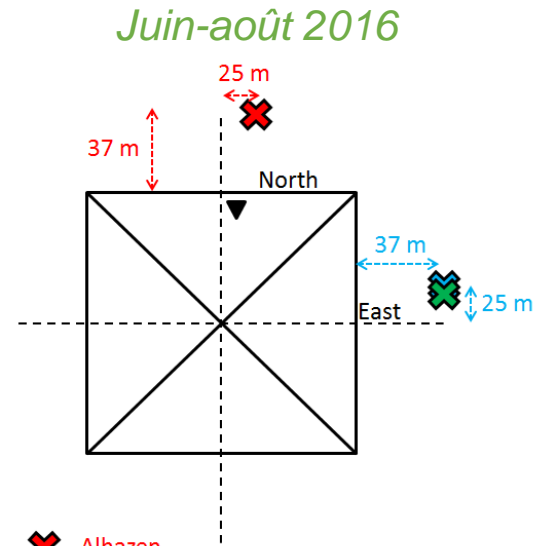

Alhazen
 Alvarez
 Brahic

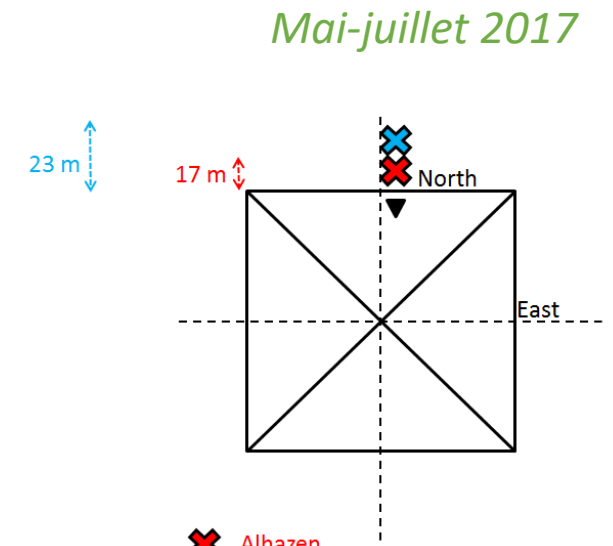

Alhazen
 Brahic

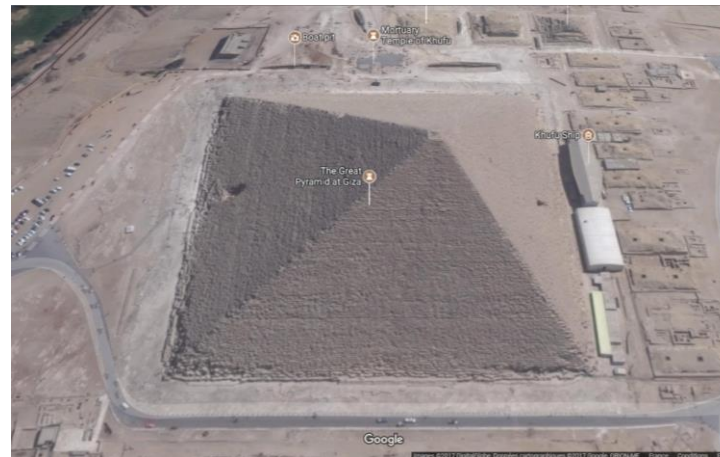
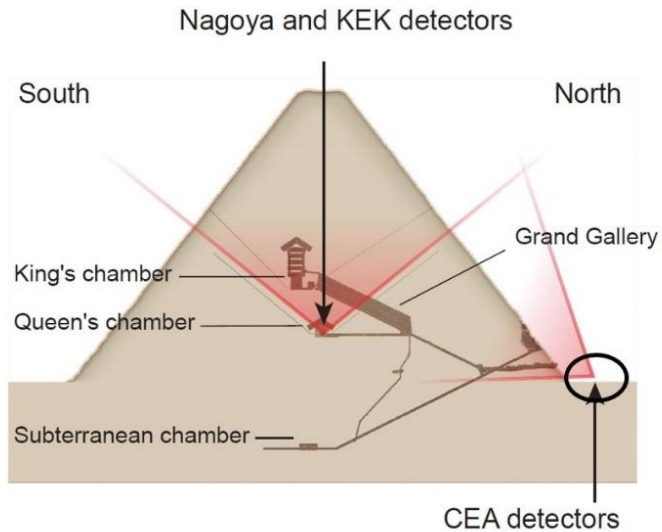

- Muographie : image 2D de la direction des muons détectés

- Photographie

- Muographie

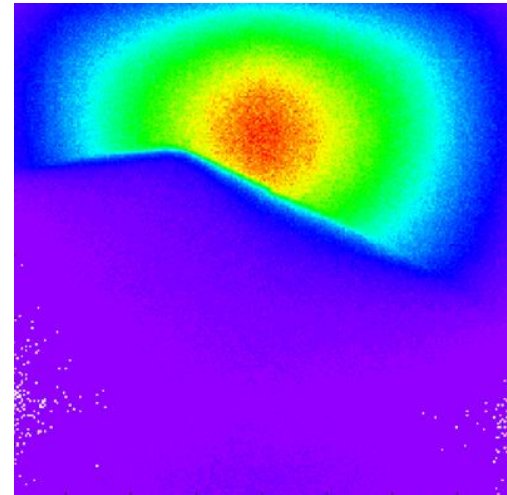

- Petits détails pas forcément directement visibles

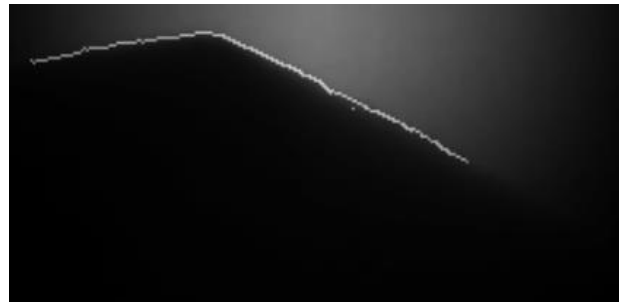
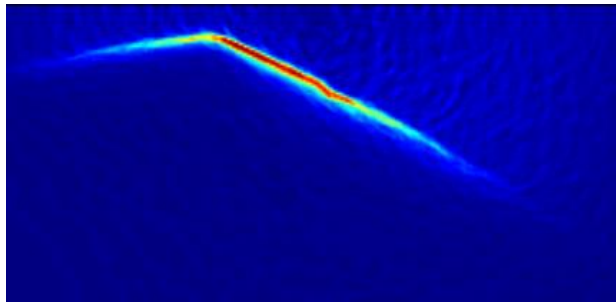

⇒ **Analyse d'image**

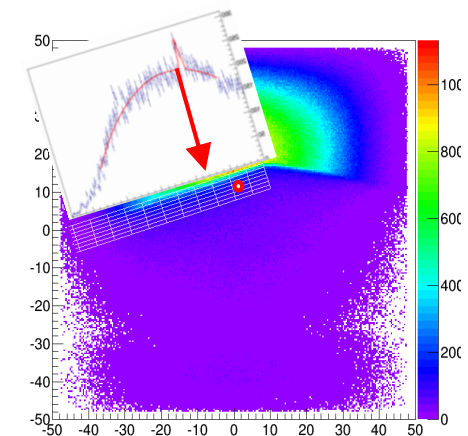

- Octobre 2016: annonce de la découverte de 2 vides dans la pyramide

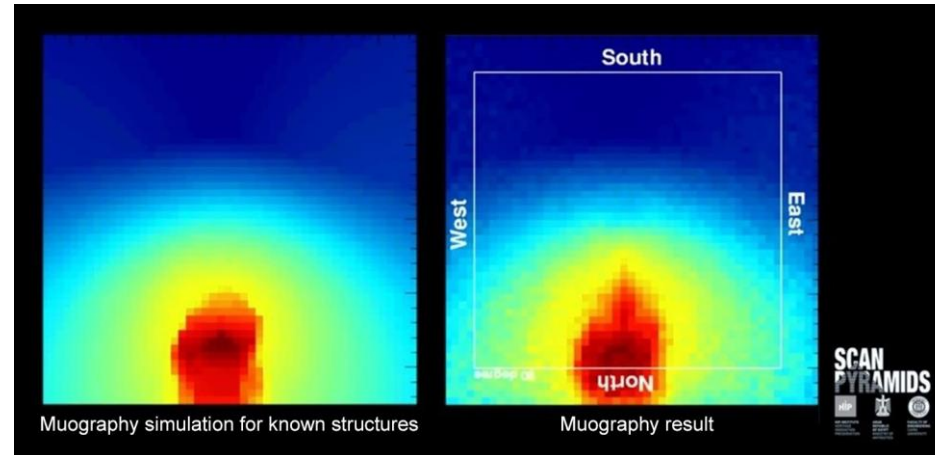
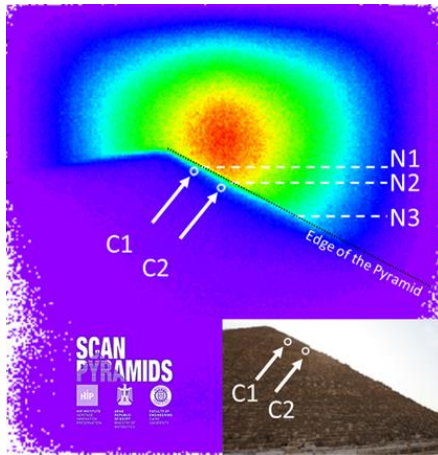

⇒ **Question pour les égyptologues: quelles sont les fonctions de ces cavités?**

- Début 2017 : résultats des plaques de Nagoya dans la chambre de la Reine
 - Excédent de muons significatif au voisinage de la grande galerie (sur l'image) ⇒ **vide**
 - Des anomalies apparaissent également sur la muo du KEK (chambre de la Reine), puis sur celle du CEA (face Nord)

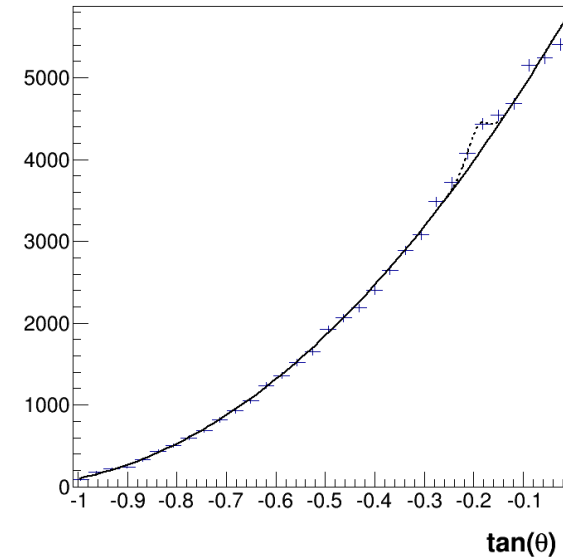
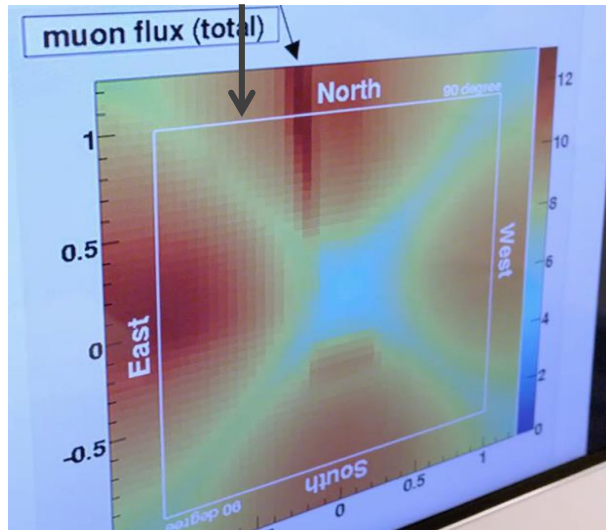

⇒ Lancement d'une campagne de mesures dédiées

- Chambre de la Reine : nouvelles plaques de Nagoya et déplacement du scintillateur KEK
- Extérieur : déplacement de Alhazen et Brahic en face des chevrons



- Ces mesures confirment la présence d'un vide au-dessus de la Grande Galerie

- Nagoya

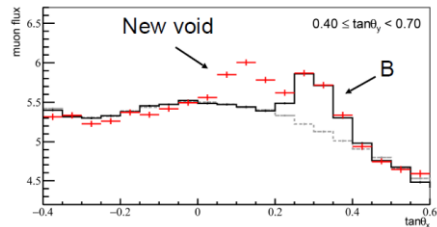
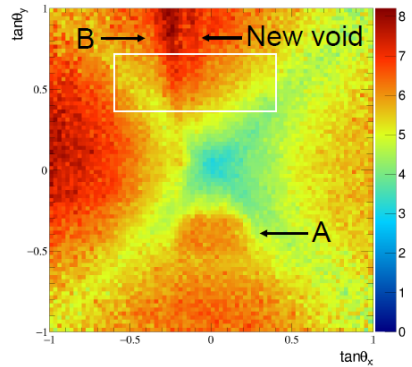

- KEK

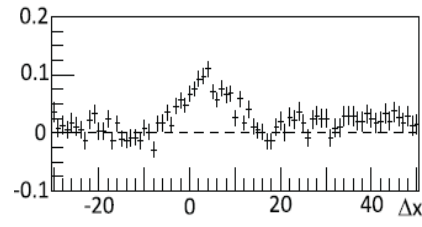
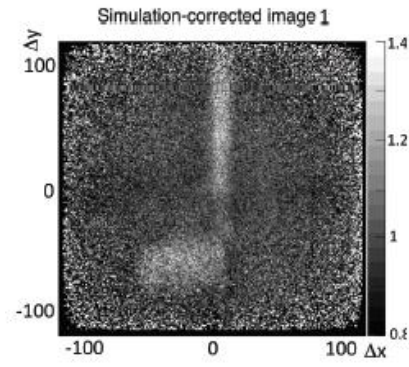

- CEA

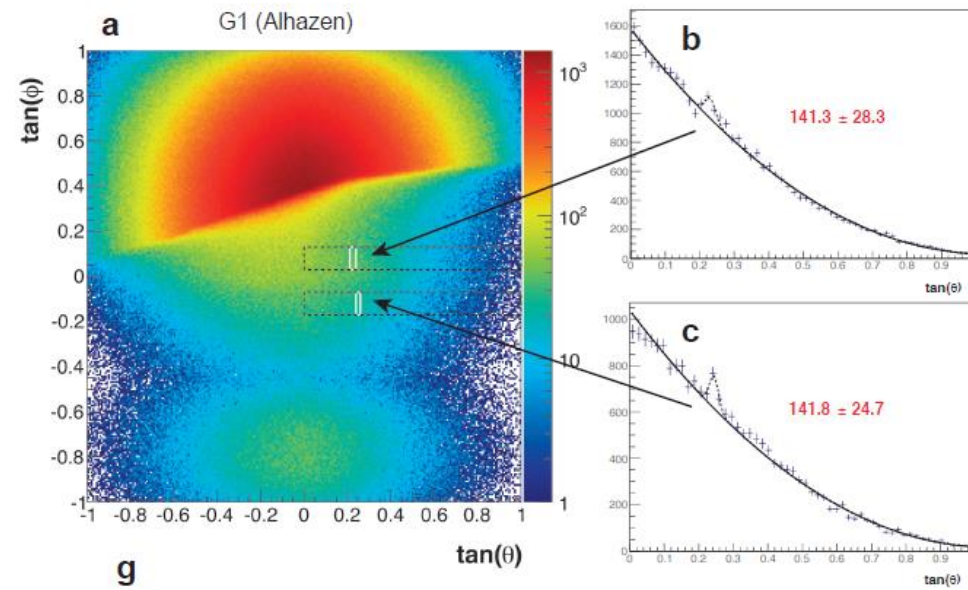

- La 3D confirme que les excédents viennent de la même zone

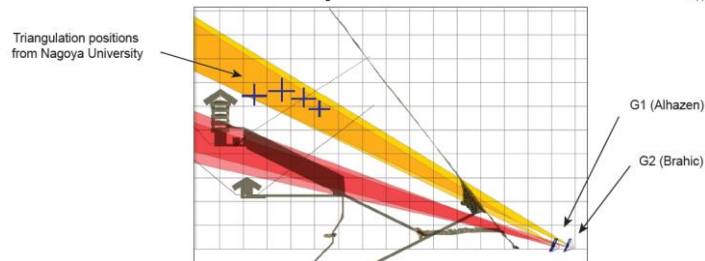

nature
International journal of science

Discovery of a big void in Khufu's Pyramid by observation of cosmic-ray muons

Kunihiro Morishima, Mitsuaki Kuno, Akira Nishio, Nobuko Kitagawa, Yuta Manabe, Masaki Moto, Fumihiko Takasaki, Hirofumi Fujii, Kotaro Satoh, Hideyo Kodama, Kohei Hayashi, Shigeru Odaka, Sébastien Procureur, David Attié, Simon Bouteille, Denis Calvet, Christopher Filosa, Patrick Magnier, Irakli Mandjavidze, Marc Riallot, Benoit Marini, Pierre Gable, Yoshikatsu Date, Makiko Sugiura, Yasser Elshayeb, Tamer Elnady, Mustapha Ezzy, Emmanuel Guerriero, Vincent Steiger, Nicolas Serikoff, Jean-Baptiste Mouret, Bernard Charlès, Hany Helal & Mehdi Tayoubi - Show fewer authors

- Besoin de réduction de la consommation en gaz (< 0.5 L/h)
 - Etude de dégazage/nettoyage des matériaux
 - Recirculation/filtration
 - Objectif d'avoir des systèmes quasi-scellés
- Autorisation nécessaire pour mettre des télescopes à l'intérieur des couloirs
 - Image précise du *Big Void*
 - Couloir de la face Nord
 - Compacité nécessaire

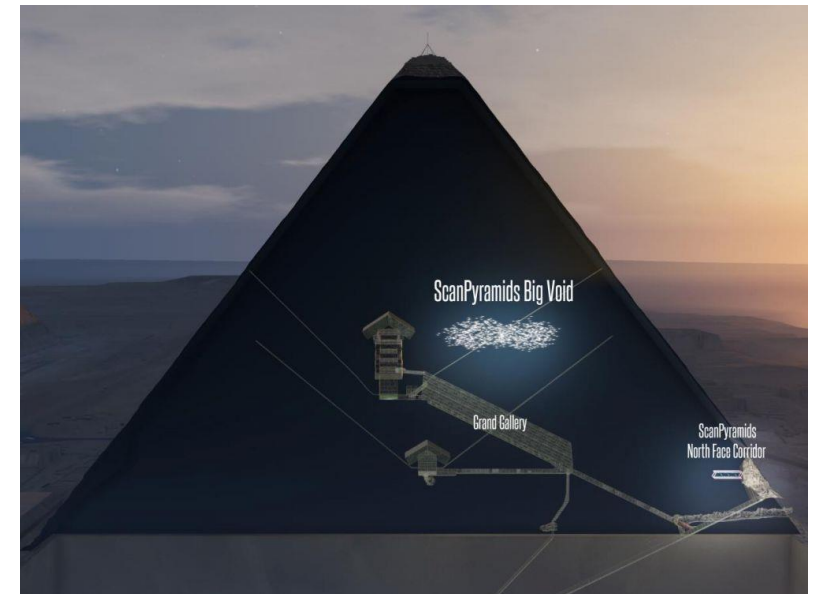

- Nécessite des situations invraisemblables





Données brutes

Données/Sim sans NFC

Données/Simu avec NFC

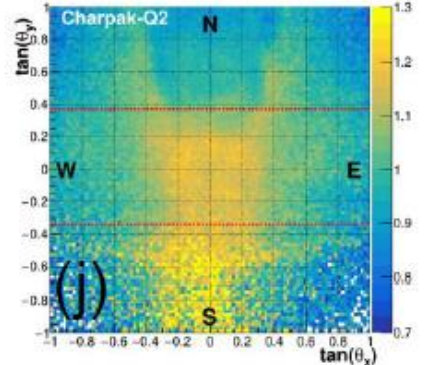
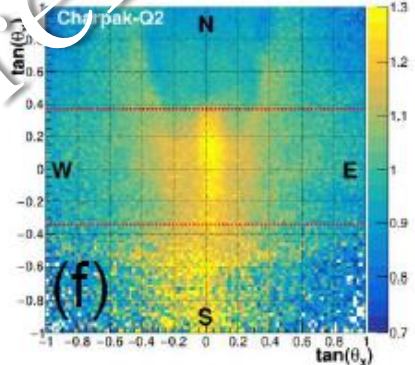
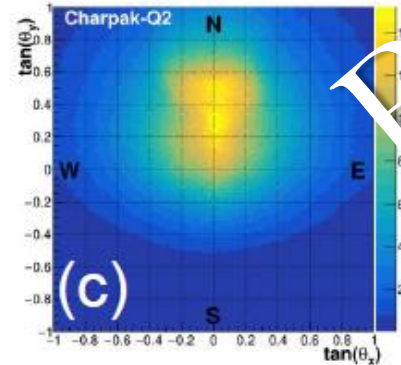
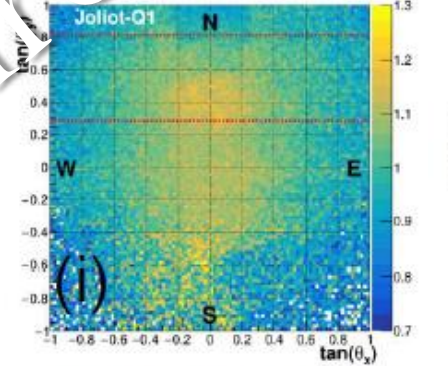
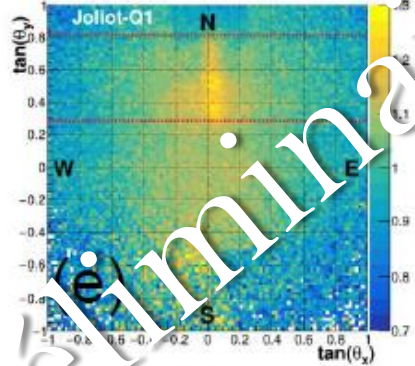
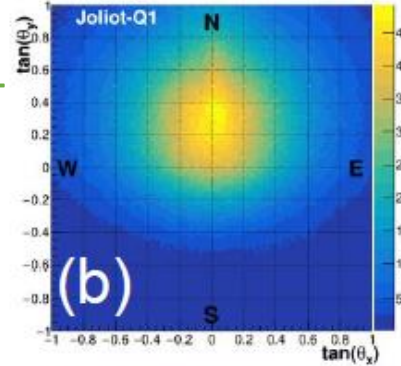
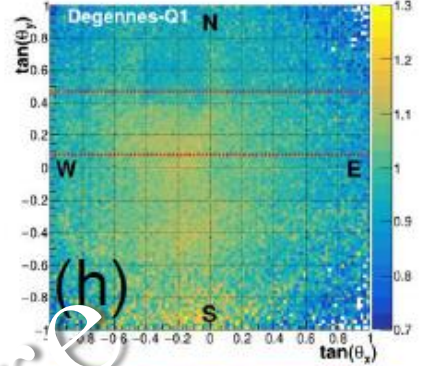
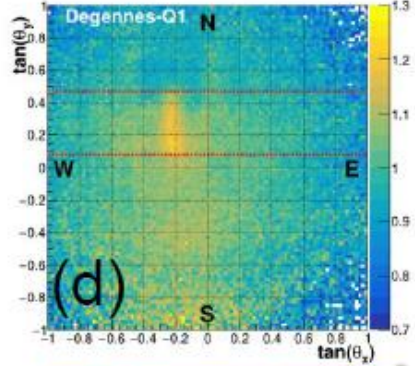
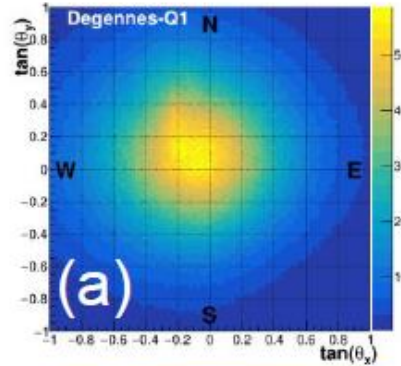

nature communications

Precise characterization of a corridor-shaped structure in Khufu's Pyramid by observation of cosmic-ray muons

Sébastien Procureur¹, Kunihiko Morishima^{2,3}, Mitsuaki Kuno², Yuta Manabe², Nobuko Kitagawa², Akira Nishio², Hector Gomez¹, David Attié¹, Ami Sakakibara², Kotaro Hikata², Masaki Moto², Irakli Mandjavidze¹, Patrick Magnier¹, Marion Lehuroux¹, Théophile Benoit¹, Denis Calvet¹, Xavier Coppolani¹, Mariam Kebbi¹, Philippe Mas¹, Hany Helal^{4,5}, Mehdi Tayoubi^{5,6}, Benoit Marini^{5,7}, Nicolas Serikoff⁵, Hamada Anwar¹, Vincent Steiger⁸, Fumihiko Takasaki⁸, Hirofumi Fujii⁸, Kotaro Satoh⁸, Hideyo Kodama⁸, Kohei Hayashi⁸, Pierre Gable⁹, Emmanuel Guerriero⁹, Jean-Baptiste Mouret¹⁰, Tamer Elnady¹¹, Yasser Elshayeb⁴, Mohamed Elkarmoty⁴

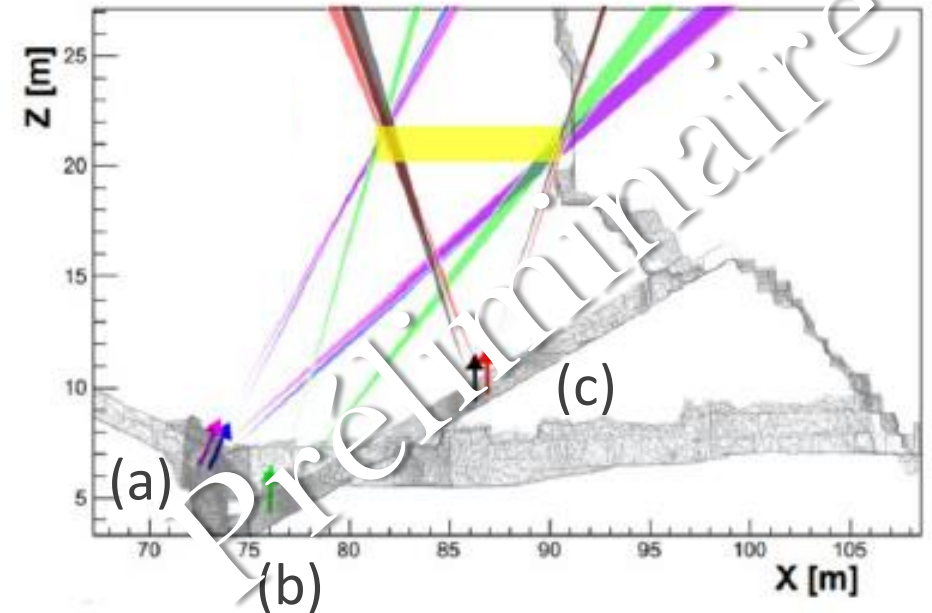
2x2x9 m³

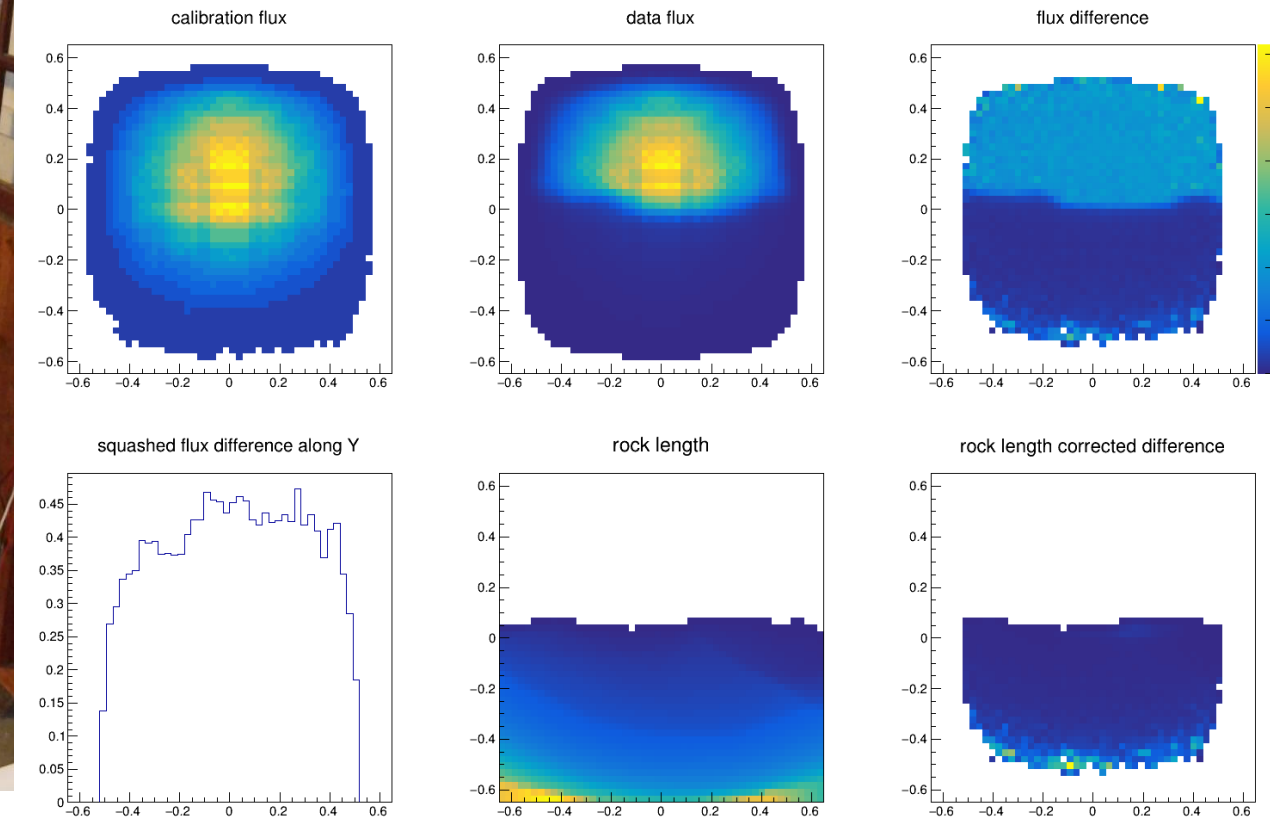
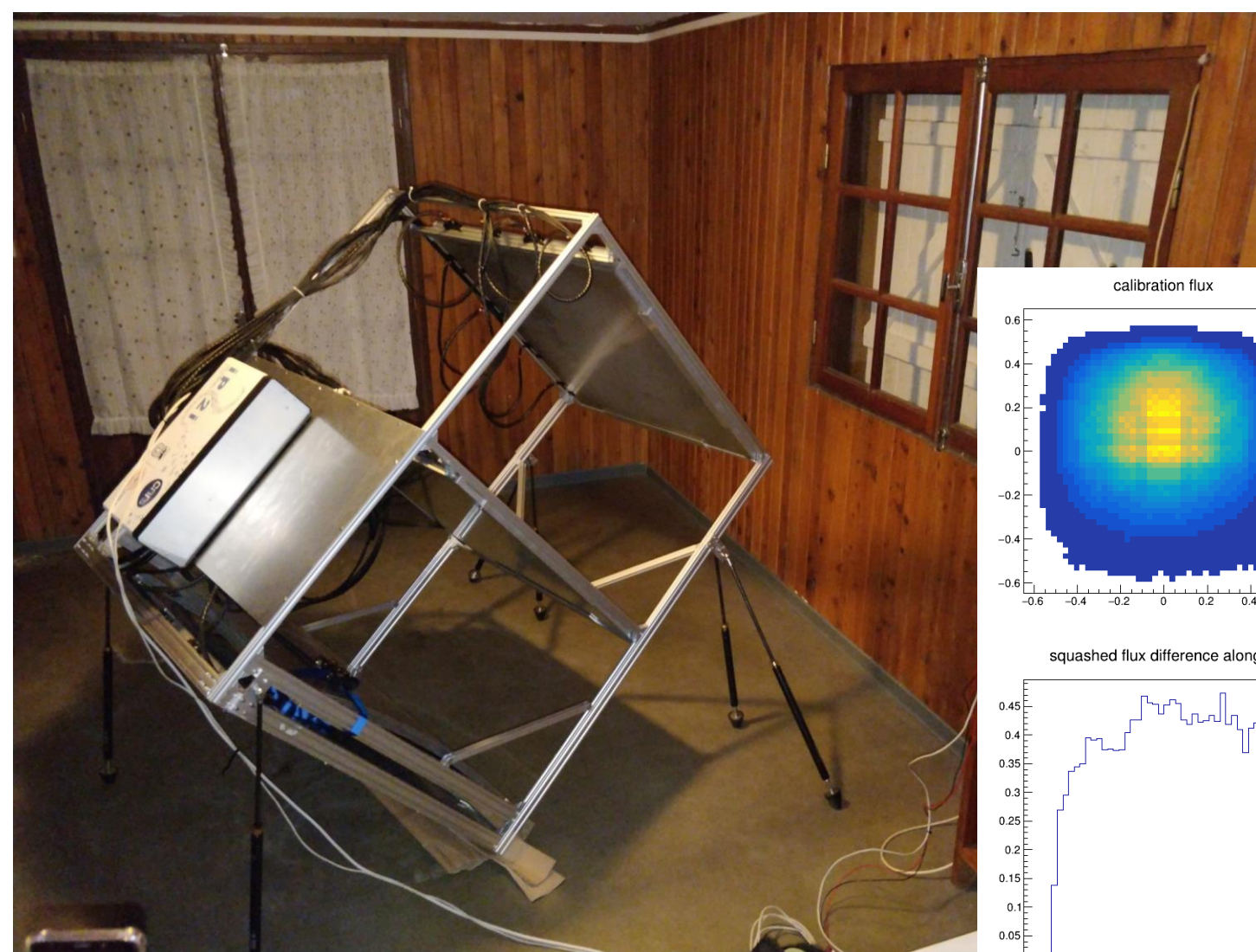

Merci !



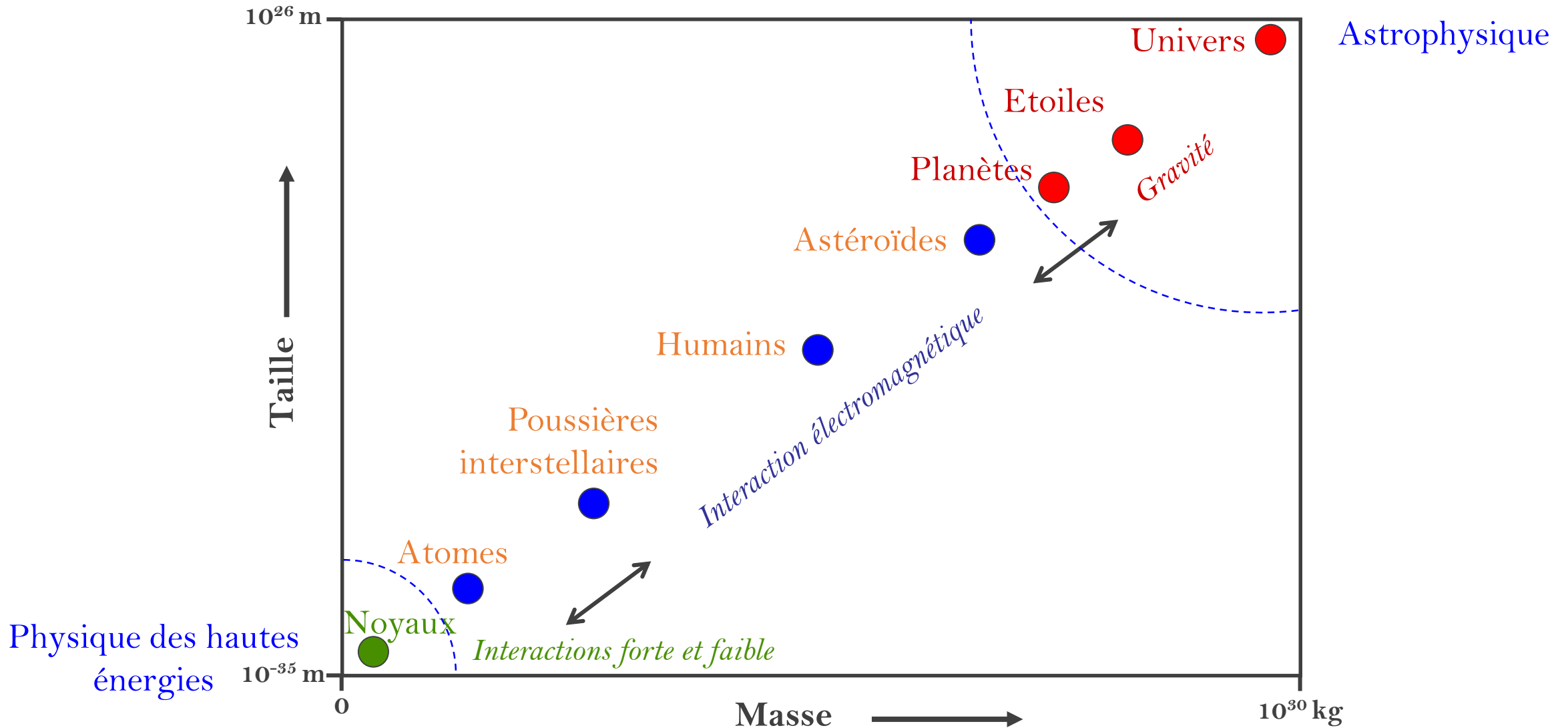

- Direction de la Recherche Fondamentale
- Institut de Recherche sur les lois Fondamentales de l'Univers

Quel est le contenu
de l'Univers?

Quels sont les constituants
ultimes de la matière ?

Infiniment petit

Infiniment grand

Elementaire

Complexe

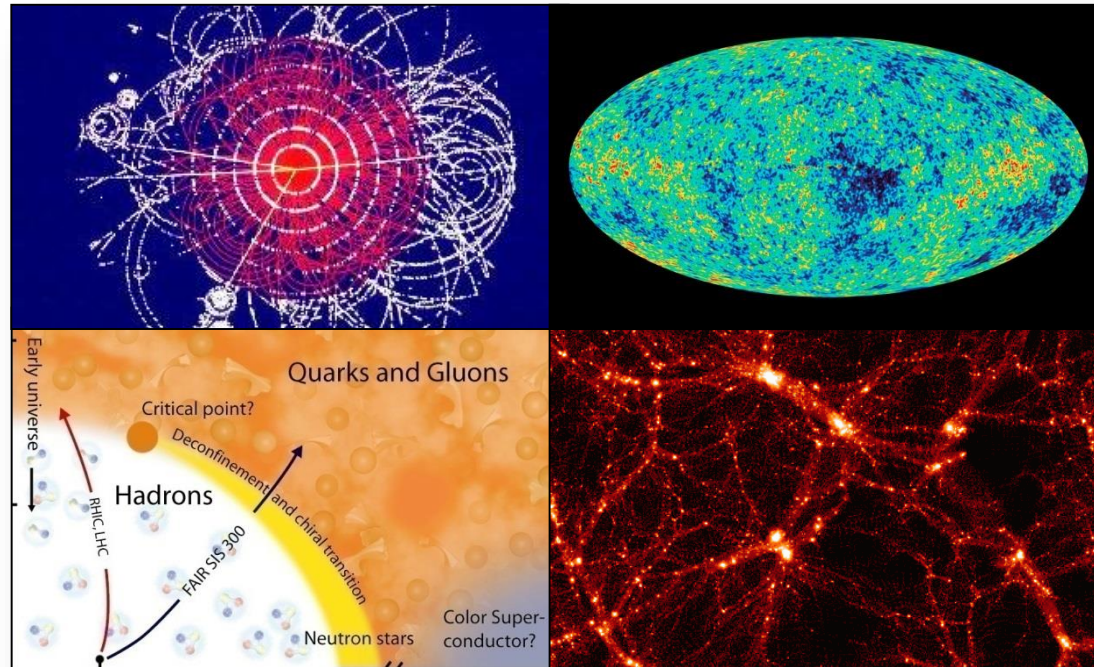

Comment les noyaux
et les particules
sont-ils créés ?

Comment l'Univers
est-il structuré ?

- Direction de la Recherche Fondamentale
- Institut de Recherche sur les lois Fondamentales de l'Univers

Grands instruments

Conception de détecteurs

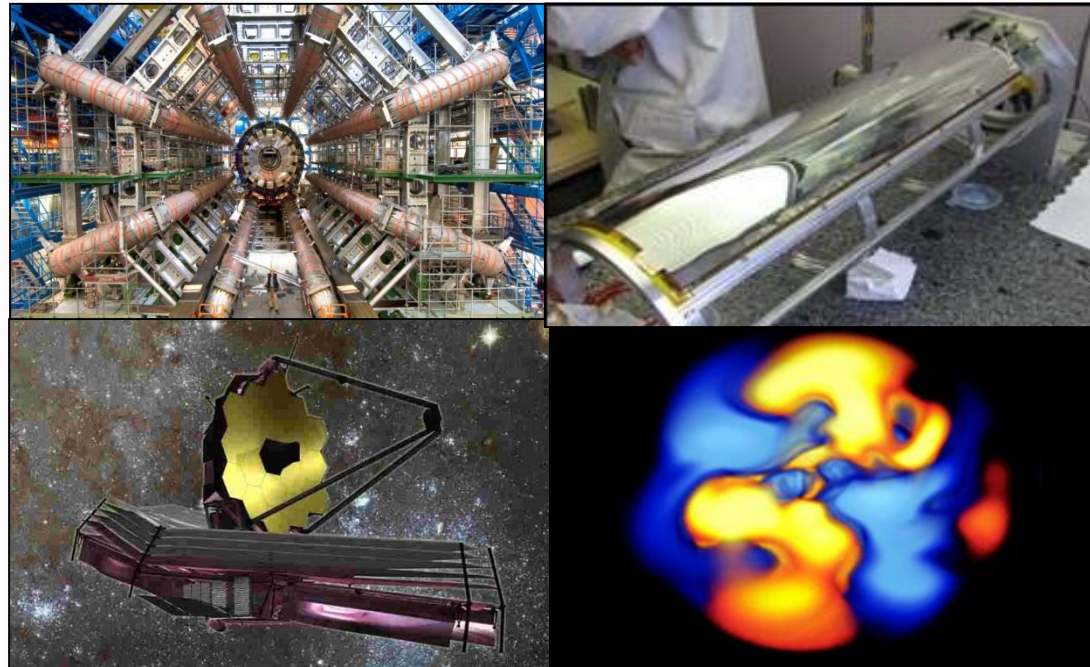

Observations
Prise et analyse de données

Simulation et
calcul haute performance

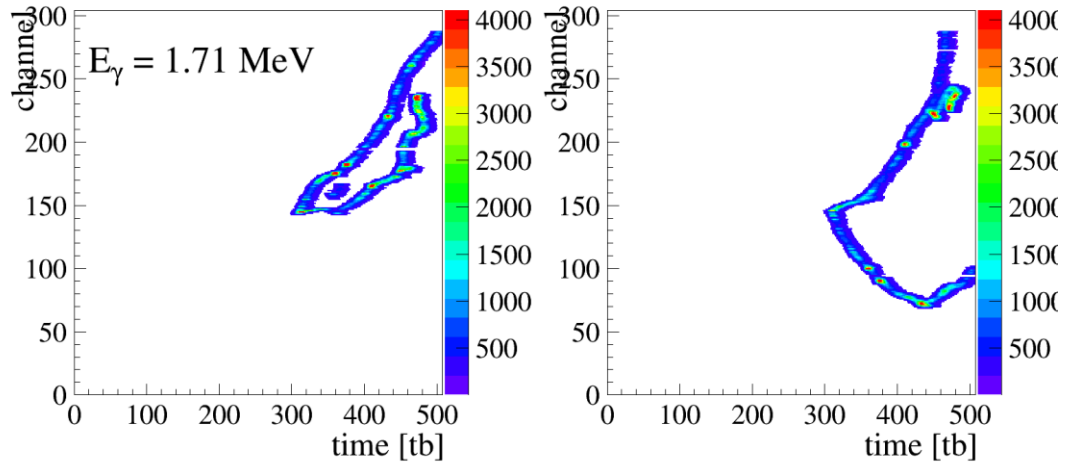
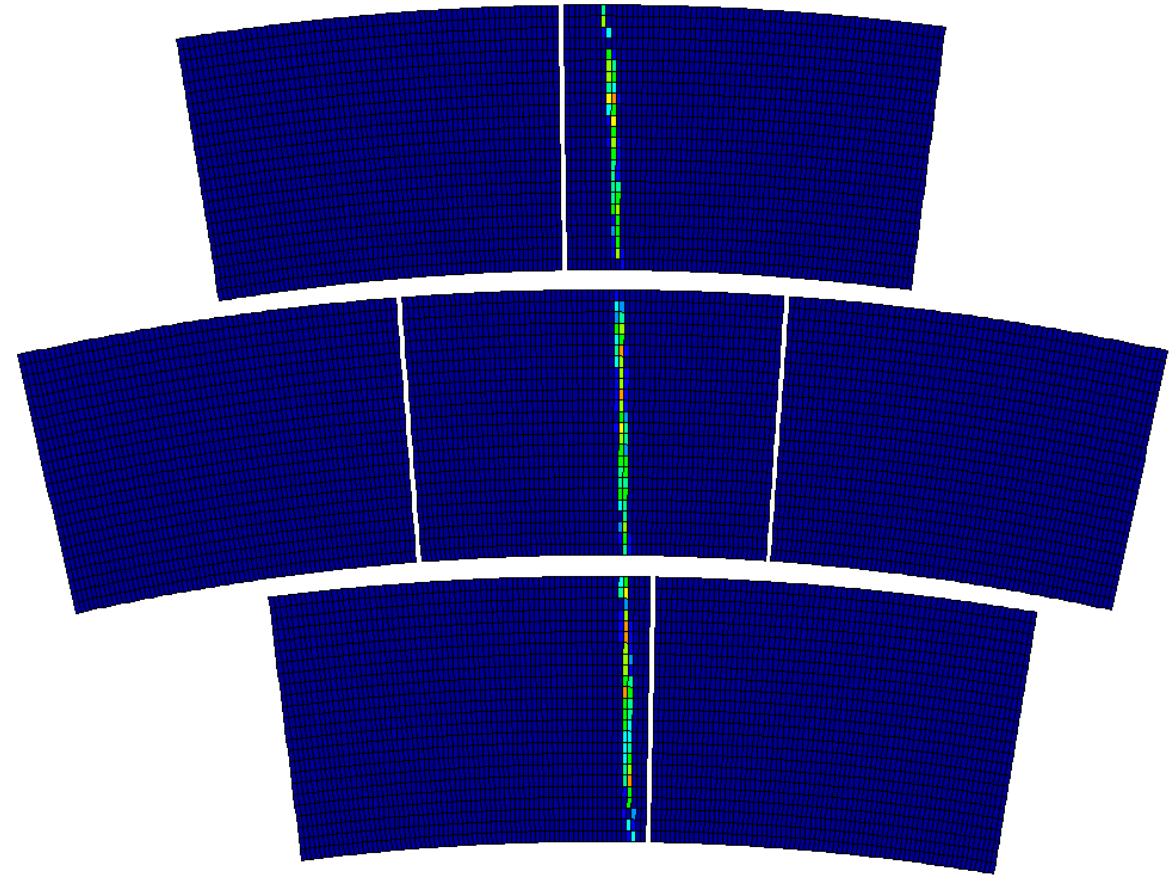
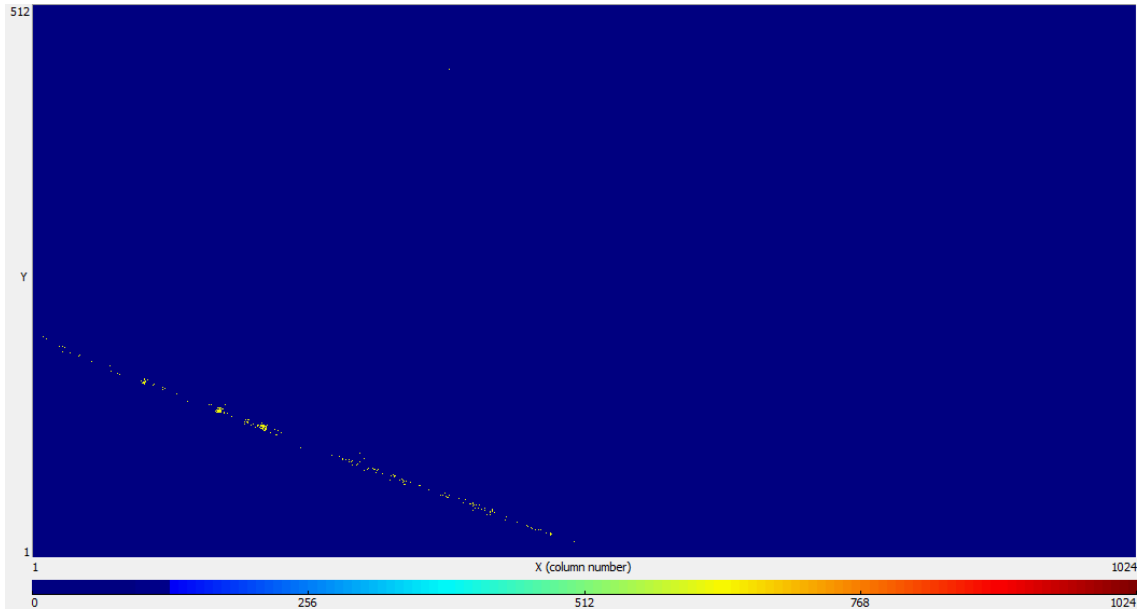

- Banc cosmique pour étudier les détecteurs des expériences de physique
- Gratuit, sans réservation contrairement aux tests en accélérateurs

