

The EIC project

Carlos Muñoz Camacho
IJCLab

Conseil Scientifique IN2P3
17 octobre, 2022

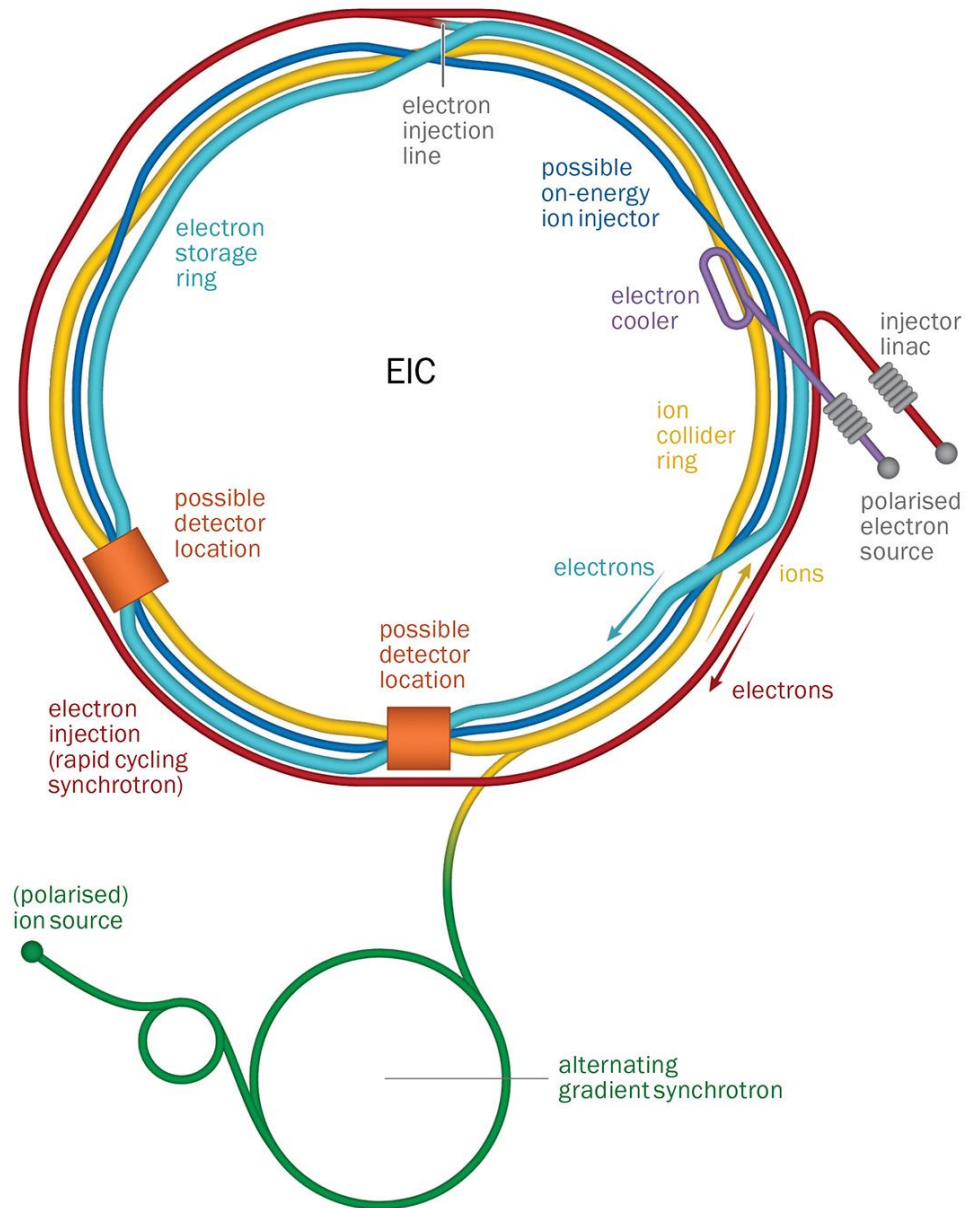

Outline

- The **Electron-Ion Collider (EIC)** science program
- The EIC facility and project
- EIC interests and activities at IJCLab
- National perspective
- Summary

Motivation – the EIC science program

Origin of spin:

How does the spin-1/2 of the nucleon arise from the spin of quarks, gluons and their orbital angular momenta?

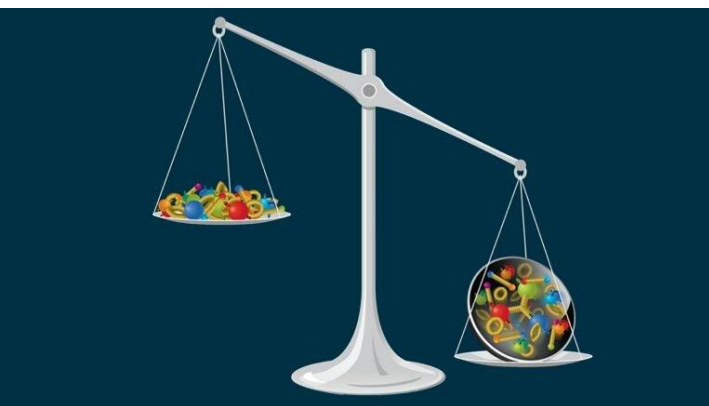
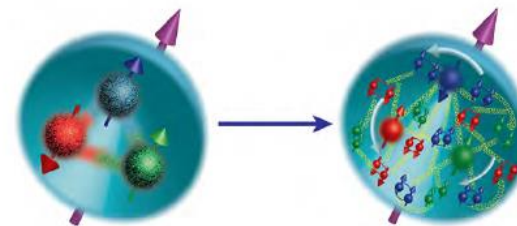

Origin of mass:

How do massless gluons make up for most of the nucleon mass?

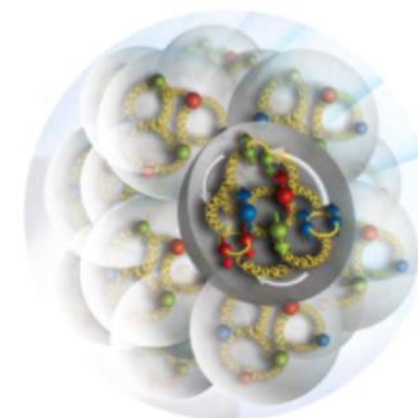

Gluons in nuclei:

Does gluon density saturate at high energy giving rise to a new regime of matter?

3D imaging of the nucleon

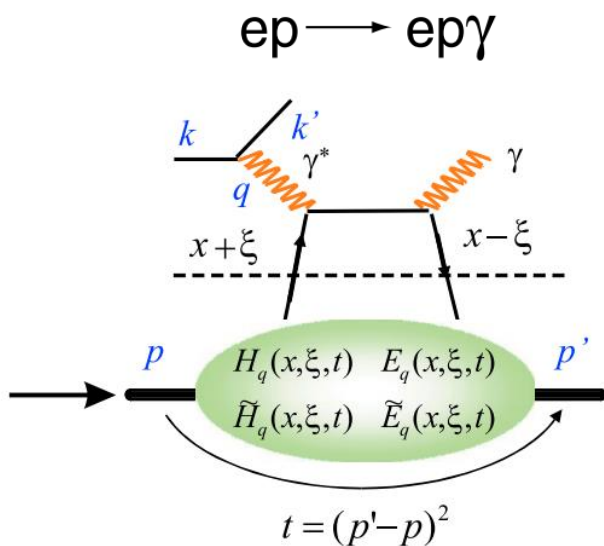

- Deeply Virtual Compton Scattering (DVCS)
- Deeply Virtual Meson Production (DVMP)
- Semi-inclusive pions, kaons... production

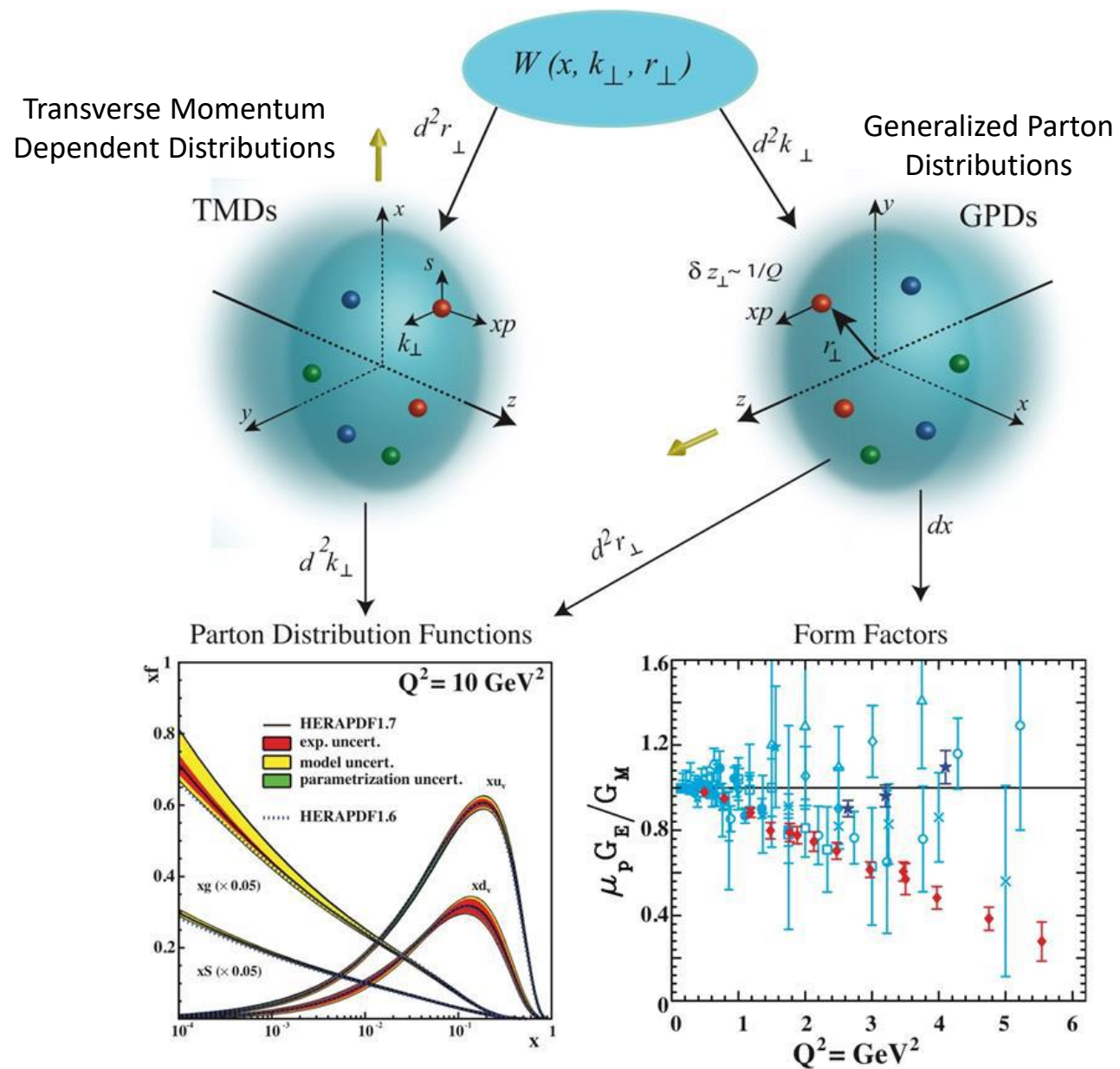

TMDs and GPDs at EIC

□ Transverse Momentum Distribution and Spatial Imaging

arXiv:1212.1701

$$f(x, k_T) \quad 1+2D$$

$$\int d^2 b_T \quad W(x, b_T, k_T) \quad \int d^2 k_T$$

$$f(x, b_T) \quad 1+2D$$

Transverse Momentum Distribution (TMD)

Wigner Distribution

Impact Parameter Distribution

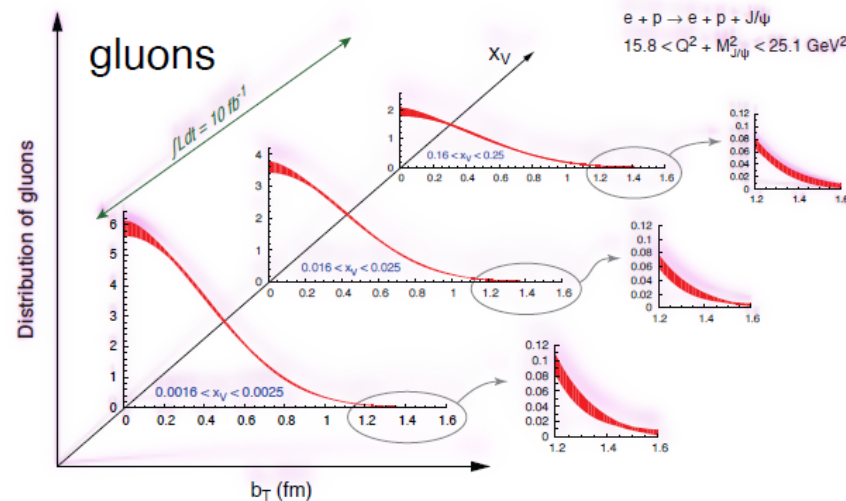
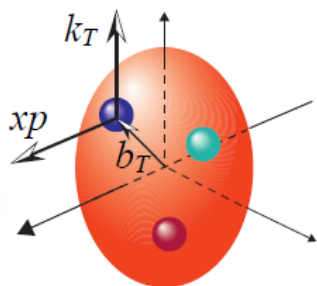
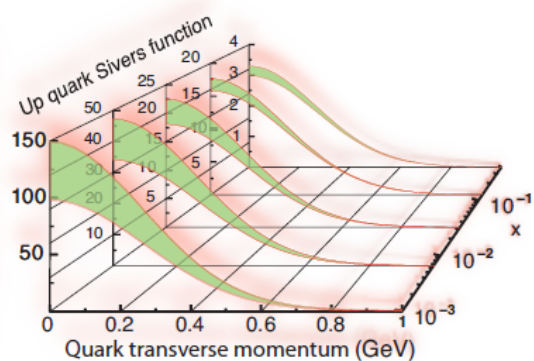
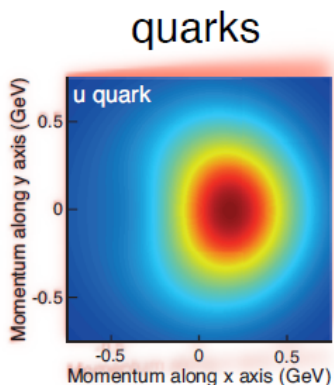

- Spin-dependent 1+2D momentum space (transverse) images from semi-inclusive scattering

- Spin-dependent 1+2D impact parameter (transverse) images from exclusive scattering

$$\begin{aligned} & \text{Fourier transf.} \\ & \downarrow \\ & b_T \longleftrightarrow \Delta: t = -\Delta^2 \\ & H(x, 0, t) \\ & \uparrow \\ & \xi = 0 \\ & H(x, \xi, t) \end{aligned}$$

Generalized Parton Distribution (GPD)

Gluon saturation

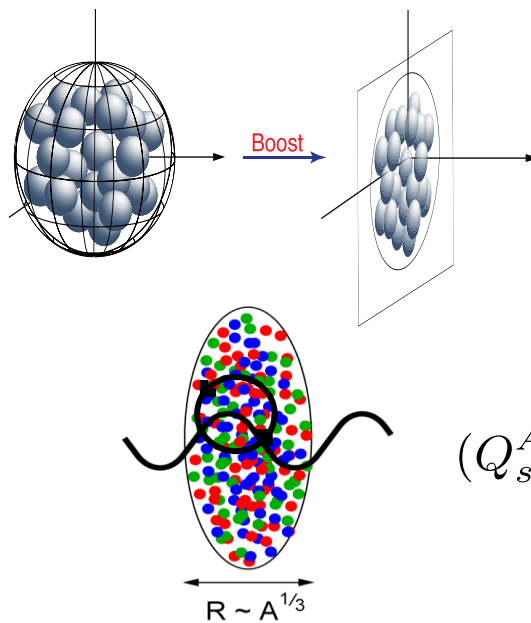
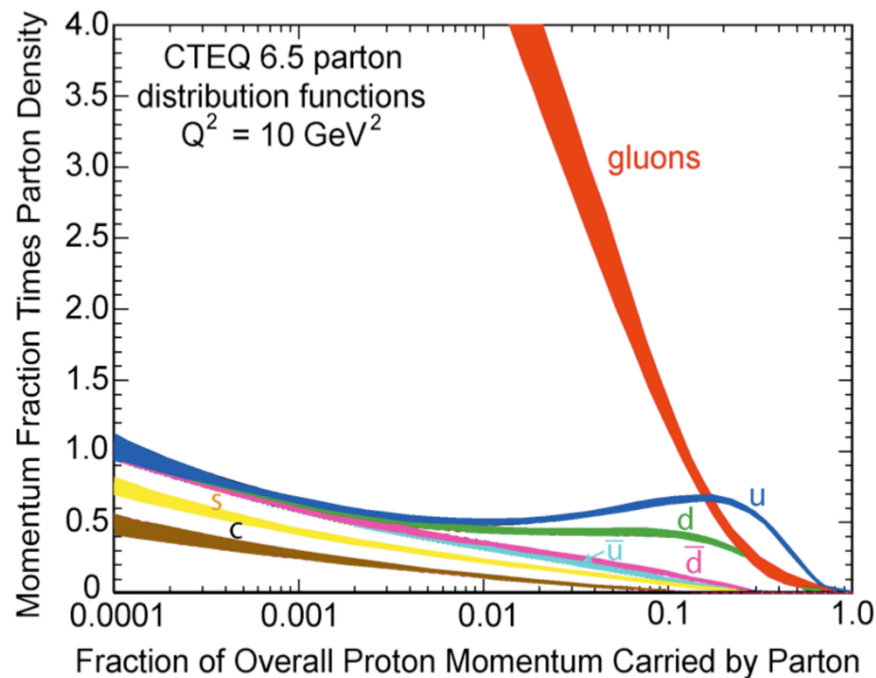

Advantage of nucleus

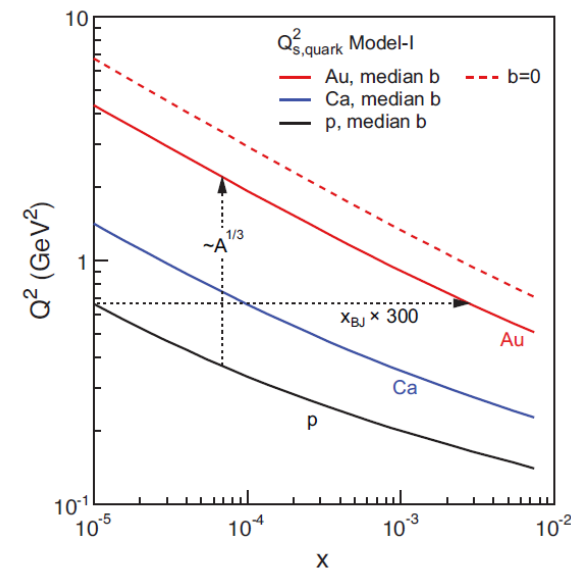

$$(Q_s^A)^2 \approx c Q_0^2 \left[\frac{A}{x} \right]^{1/3}$$

$$L \sim (2m_N x)^{-1} > 2 R_A \sim A^{1/3}$$

Enhancement of Q_s with A :
 Saturation regime reached at significantly lower energy (read: "cost") in nuclei

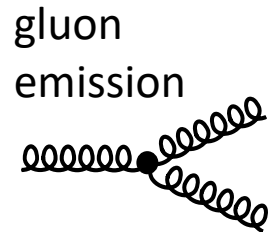

=

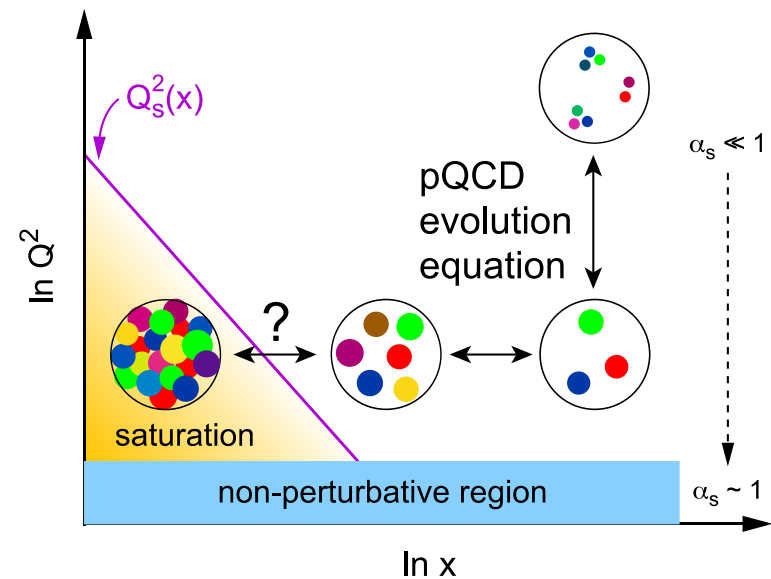
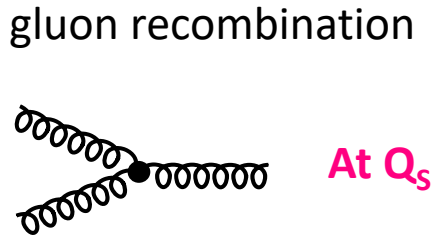

Diffractive events and gluon densities

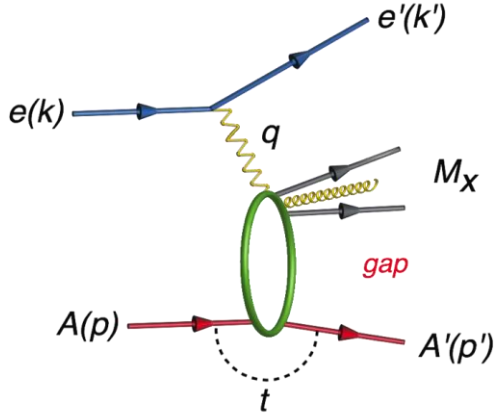

Diffraction cross-sections have strong discovery potential:

High sensitivity to gluon density in linear regime: $\sigma \sim [g(x, Q^2)]^2$

Dramatic changes in cross-sections with onset of non-linear strong color fields

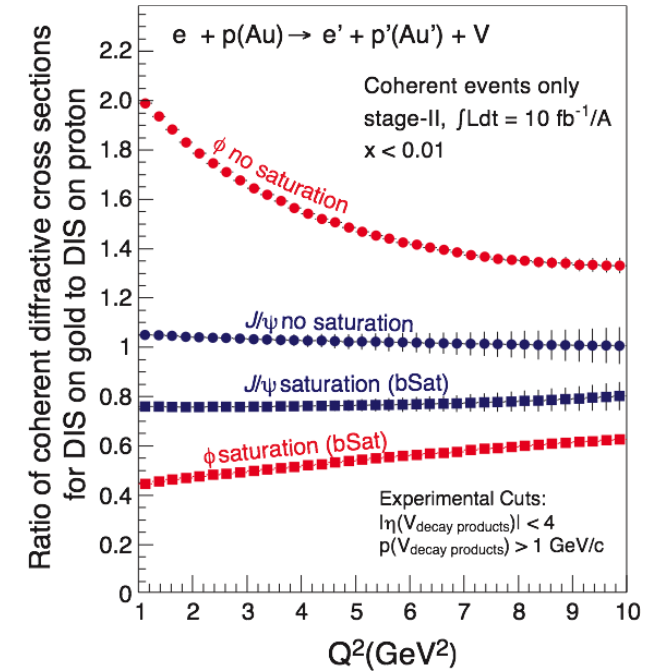
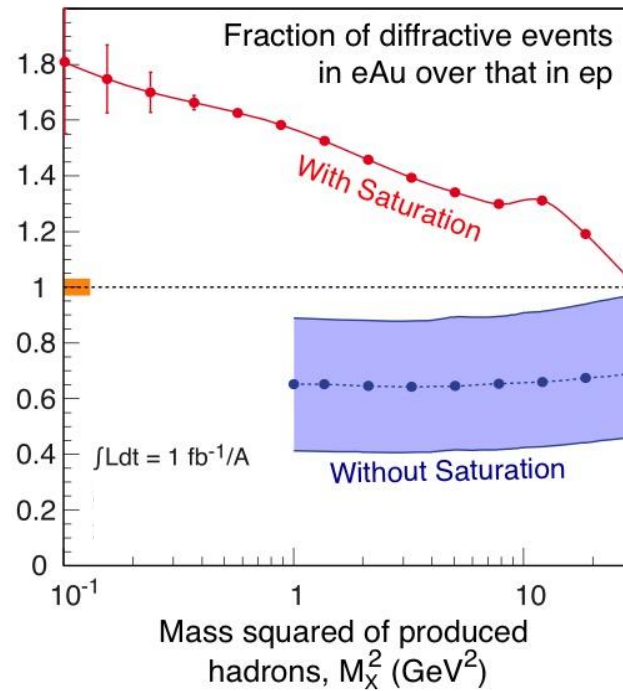

Hadronization: emergence of hadrons from partons

Unprecedented ν , the virtual photon energy range @ EIC : precision & control

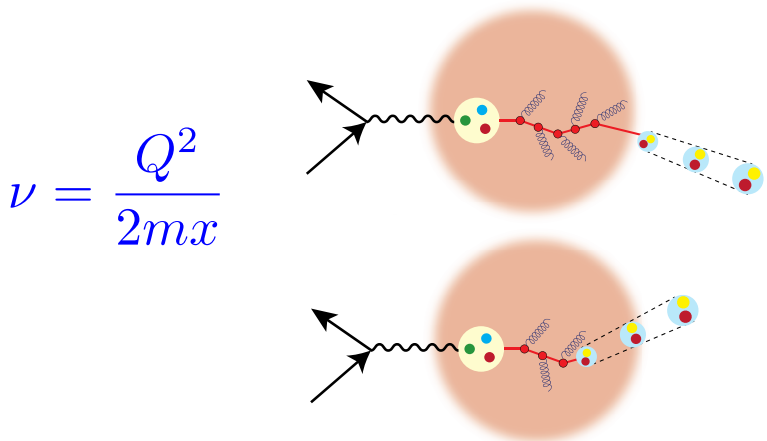

Control of n by selecting kinematics;
Also under control the nuclear size.

Colored quark emerges as color neutral hadron

What is the impact of colored media on confinement?

Energy loss by light vs. heavy quarks:

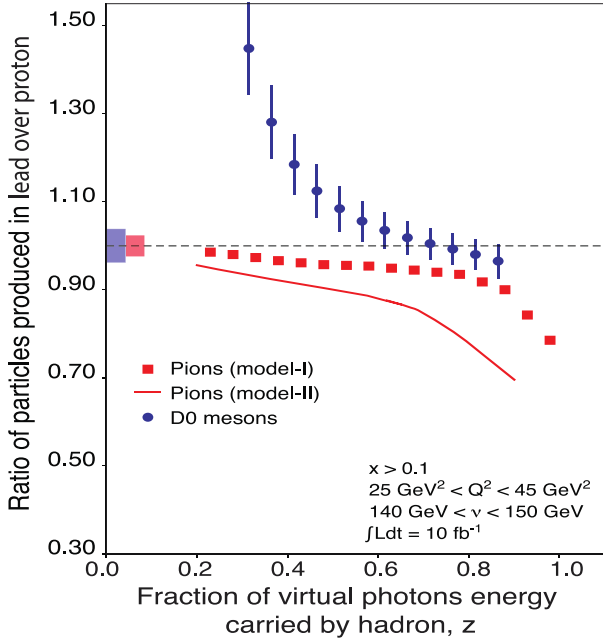

Identify light vs. charm hadrons in e-A:

Understand energy loss of light vs. heavy quarks
in cold nuclear matter.

Provides insight into energy loss in the Quark-Gluon Plasma

DIS at collider energies enables control of parton/event kinematics

Origin of mass

- Threshold J/Ψ production as a function of Q^2 is sensitive to the trace anomaly contribution to the proton mass
- Meson structure measurements (structure function & form factor) probe the hadron mass generation through chiral symmetry breaking

Pion form factor: measurements up 30 GeV^2

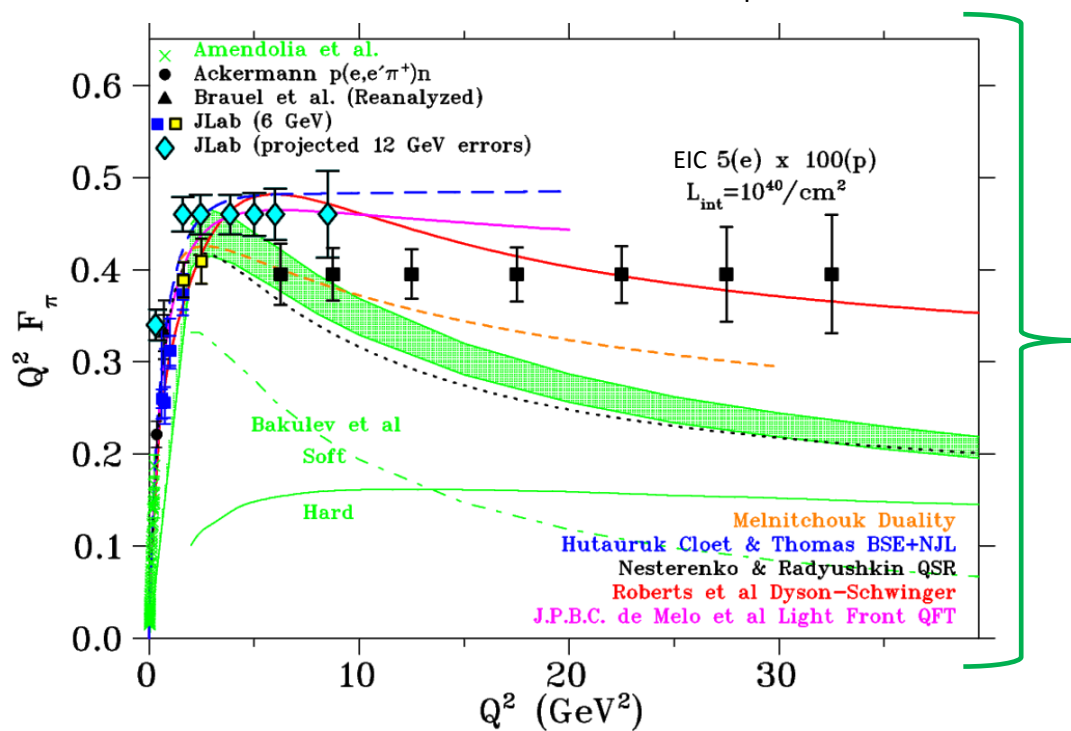

Far-forward detectors are key for reconstructing mesons at very forward η

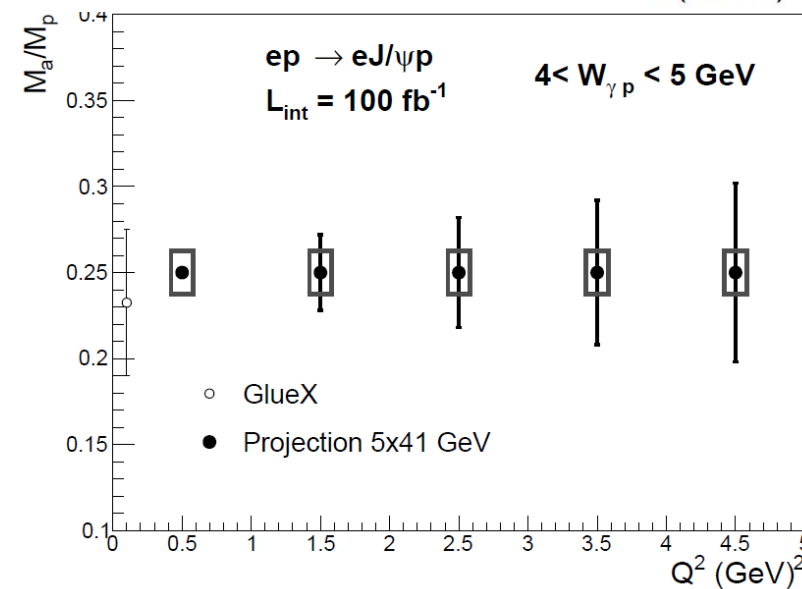
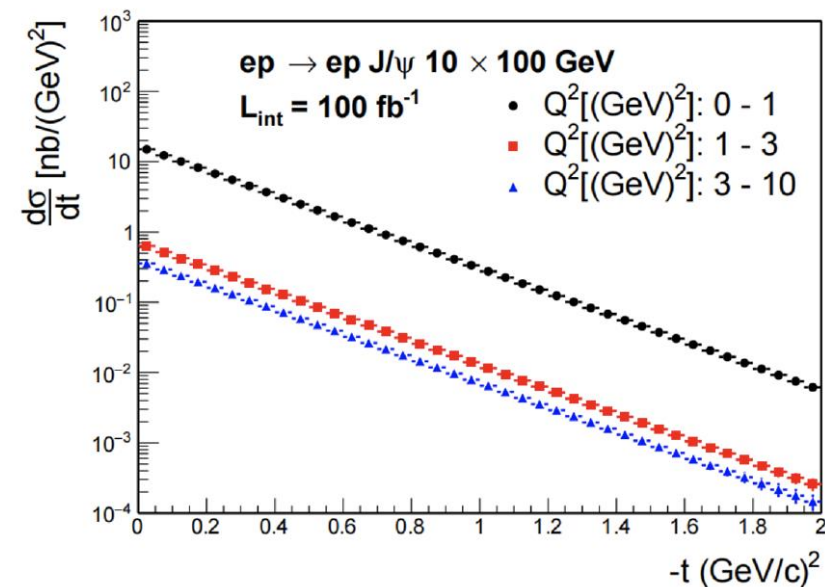

The EIC facility

- Highly polarized electron / Highly polarized proton and light ions /Unpolarized heavy ions
- CME: $\sim 20\text{--}140$ GeV
- Luminosity: $\sim 10^{33\text{--}34}$ $\text{cm}^{-2}\text{s}^{-1}$

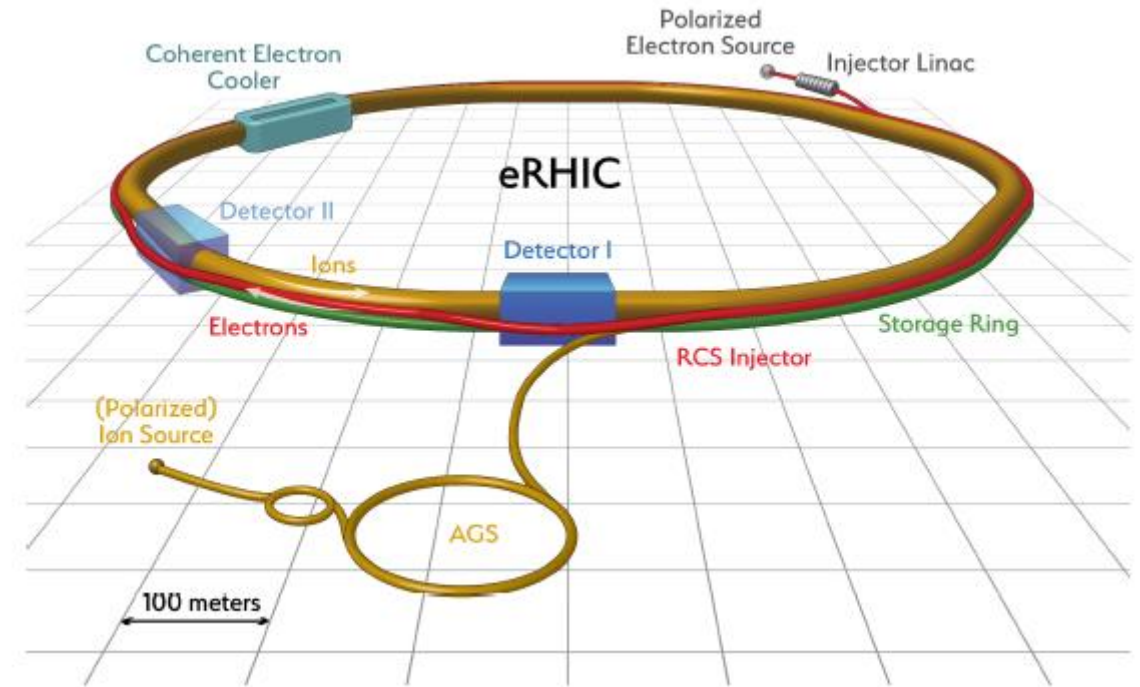

- Polarized electron source and 400 MeV injector linac
- Polarized proton beams and ion beams based on existing RHIC facility
- 2 detector interaction points capability in the design
- ERL for strong hadron cooling

Luminosity and kinematic coverage

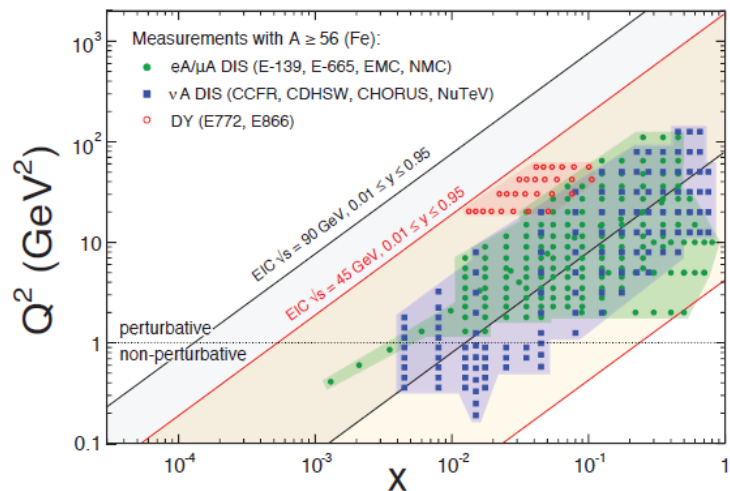
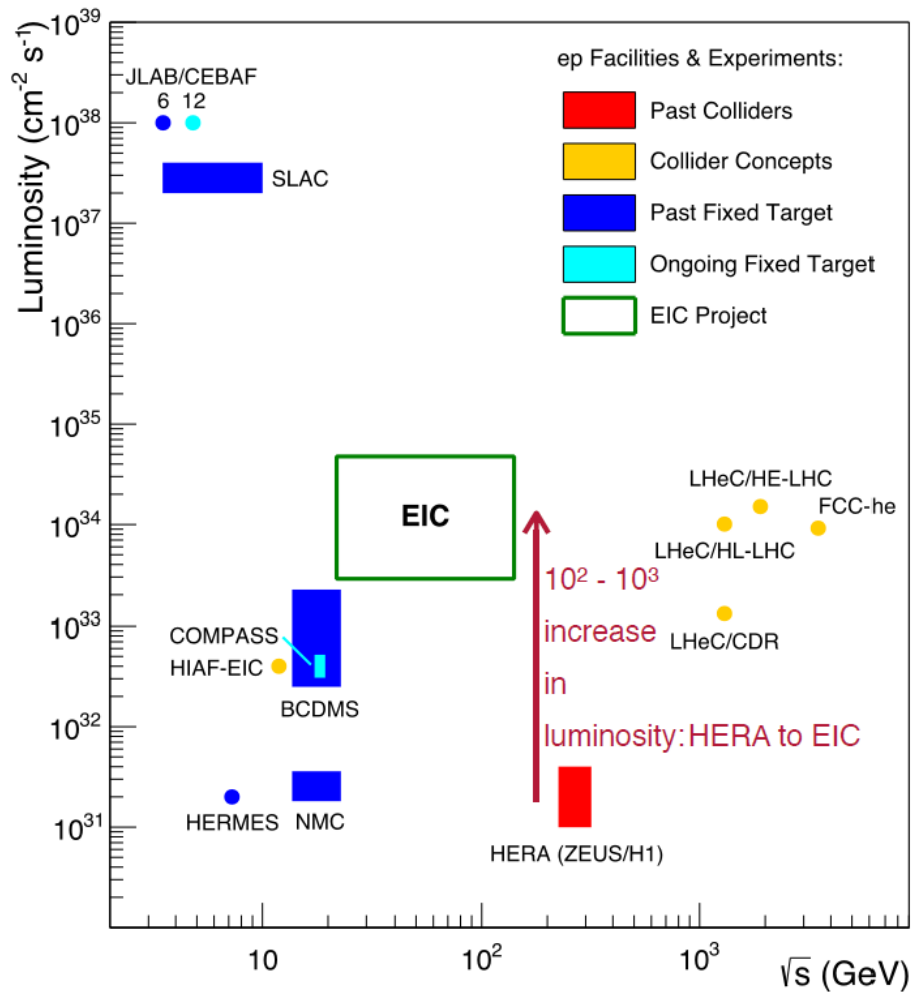

eA

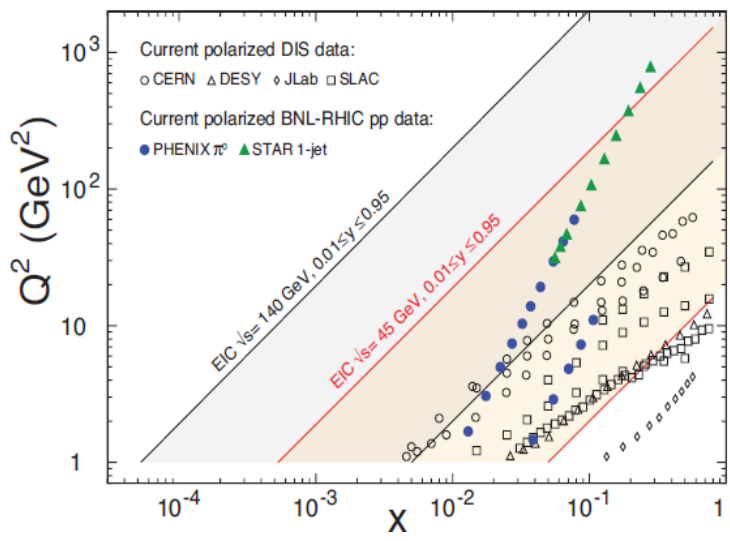

ep

The EIC Users Group

Formed in 2016, currently:

- 1361 collaborators,
- 36 countries,
- 267 institutions as of today



EIC Institutions

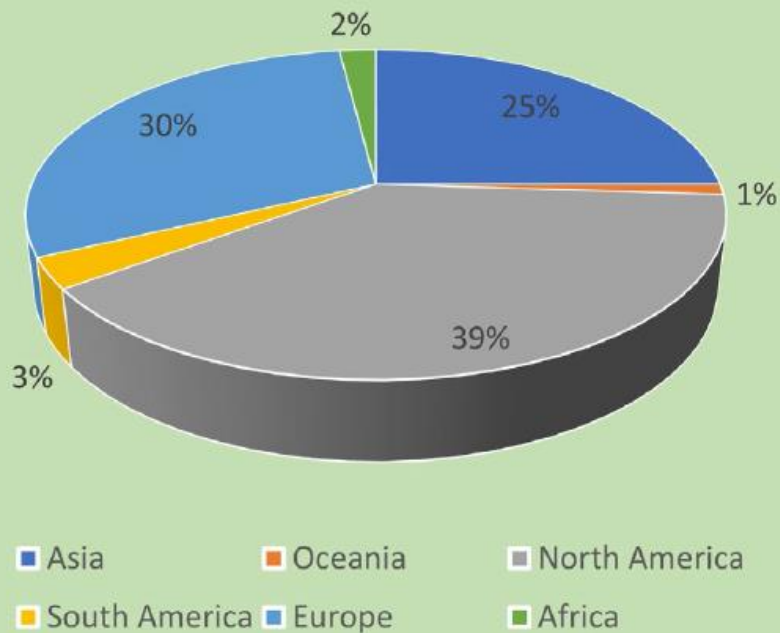

Annual EICUG meeting:

- 2016 UC Berkeley, CA
- 2016 Argonne, IL
- 2017 Trieste, Italy
- 2018 CUA, Washington, DC
- 2019 Paris, France
- 2020 Miami, FL
- 2021 VUU, VA & UCR, CA
- 2022 Stony Brook U, NY
- 2023 Warsaw, Poland

EICUG membership @ time of EICUG Meetings

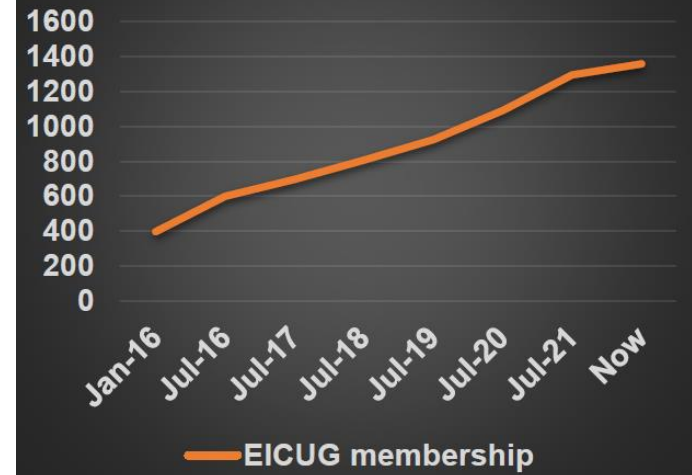

International participation growing

EIC development: some critical steps

- INT workshop series (2010) and white paper (2012, updated in 2014 for LRP)
- 2015: US Long-range plan (LRP)
Recommendation 3: construct a high-luminosity polarized electron-ion collider (EIC) as the **highest priority for new construction** following the completion of FRIB
- 2018: Review of the EIC science case by the National Academy of Sciences
“The committee finds that the science that can be addressed by an EIC is **compelling, fundamental and timely.**”
- 2020: DoE announcement of CD-0 (“mission need”) and site selection (Brookhaven National Lab)
- 2020: Yellow report initiative

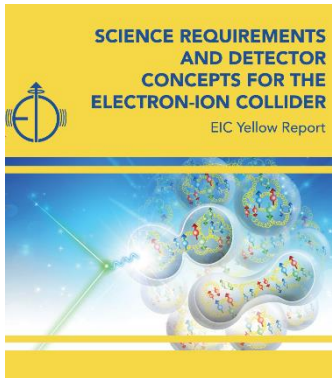
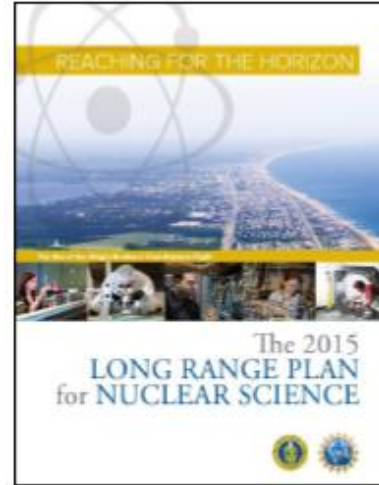

Goal: advance the state and detail of the documented [physics studies](#) (White Paper, INT program proceedings) and [detector concepts](#) in preparation for the realization of the EIC.

Strong involvement of the French community (both theorists and experimentalists)

[2103.05419](#) (3/2021), Nucl. Phys. A 1026 (2022) 122447

Recent activity (2021)

- EIC Conceptual Design Report (CDR)
- Call for detector proposals

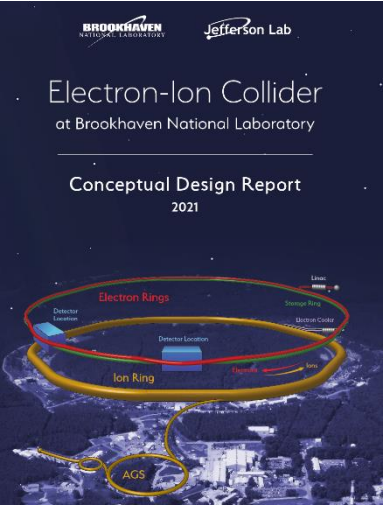

Three proposals submitted:

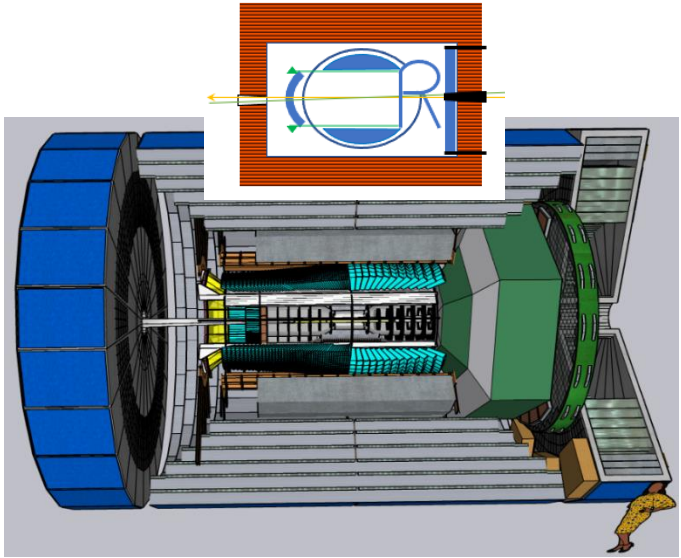
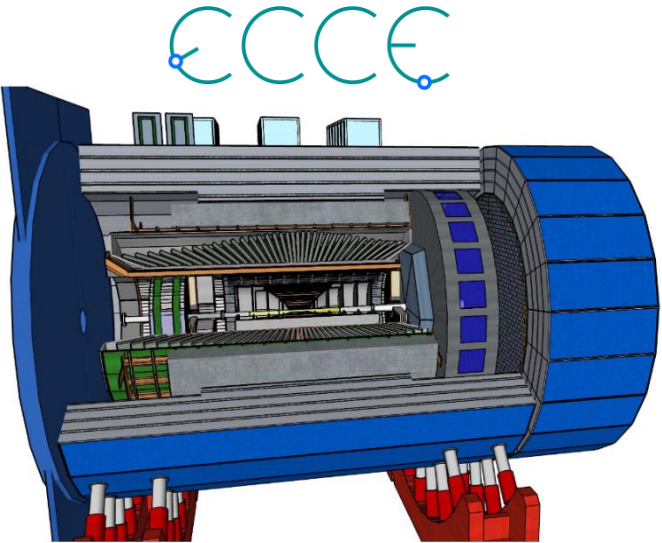
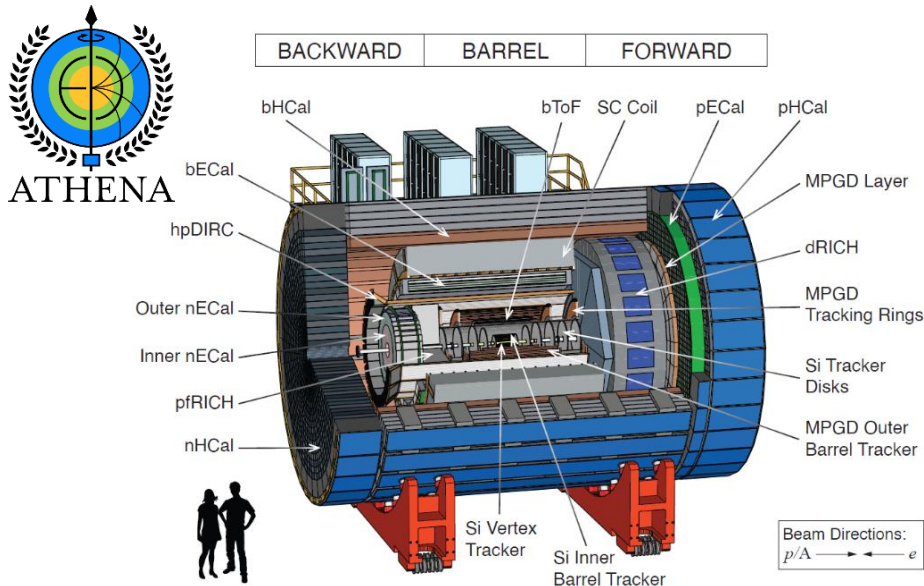

The EIC project detector: ePIC

Tracking:

- New 1.7T solenoid
- Si MAPS Tracker
- MPGDs (μ RWELL/ μ Megas)

PID:

- hpDIRC
- mRICH/pfRICH
- dRICH
- AC-LGAD (~ 30 ps TOF)

Calorimetry:

- SciGlass/Imaging Barrel EMCal
- PbWO_4 EMCal in backward direction
- Finely segmented EMCal +HCal in forward direction
- Outer HCal (sPHENIX re-use)

hadronic calorimeters

Solenoidal Magnet

e/m calorimeters

ToF, DIRC, RICH detectors

MPG trackers

MAPS tracker

25 subdetectors incl. polarimeters

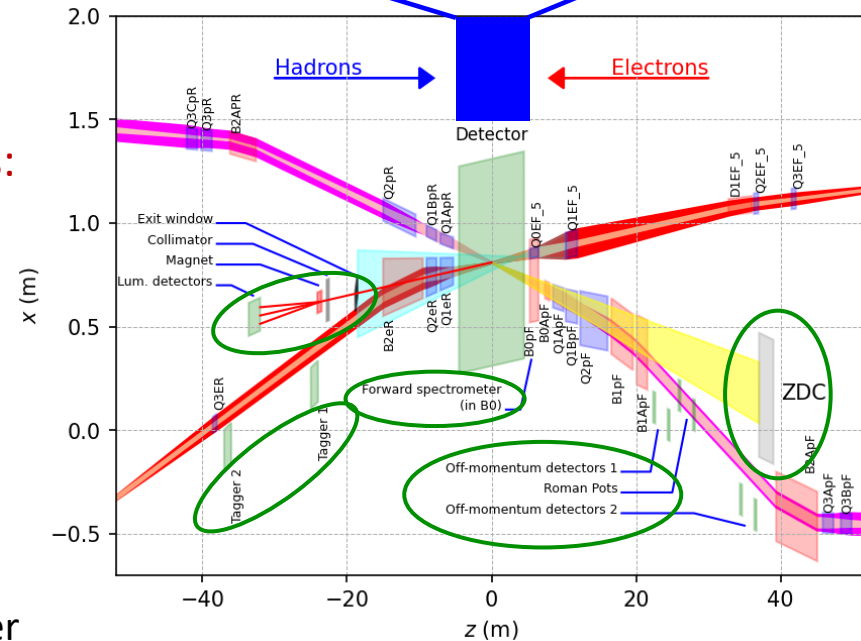
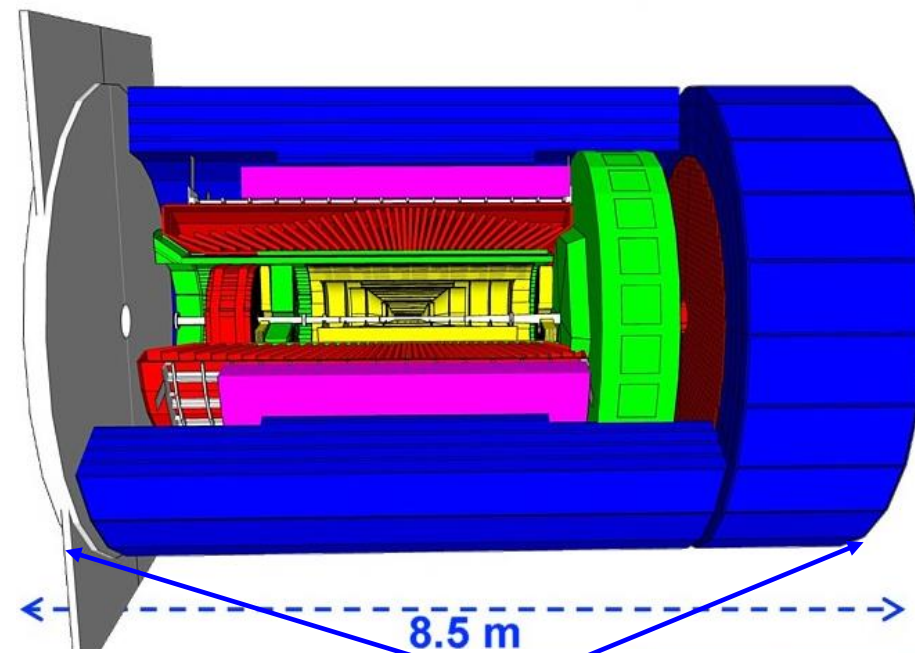

Far-Backward Detectors:

- Luminosity monitor.
- Low- Q^2 Tagger

Far-Forward Detectors:

- B0 Tracking and Photon Detection
- Roman Pots and Off-Momentum Detectors.
- Zero-Degree Calorimeter

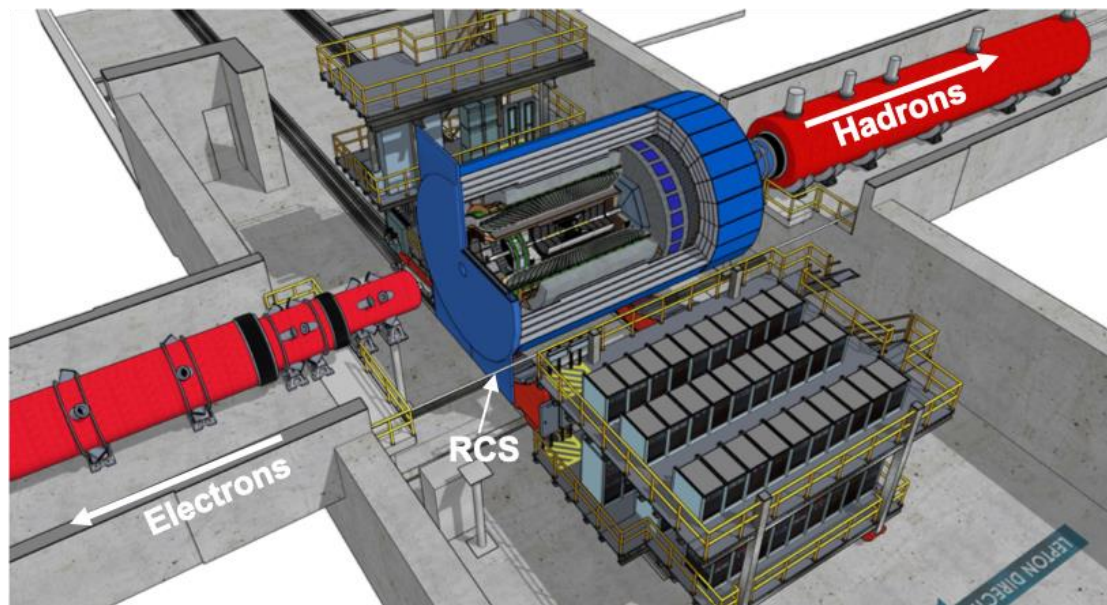

EIC project timeline

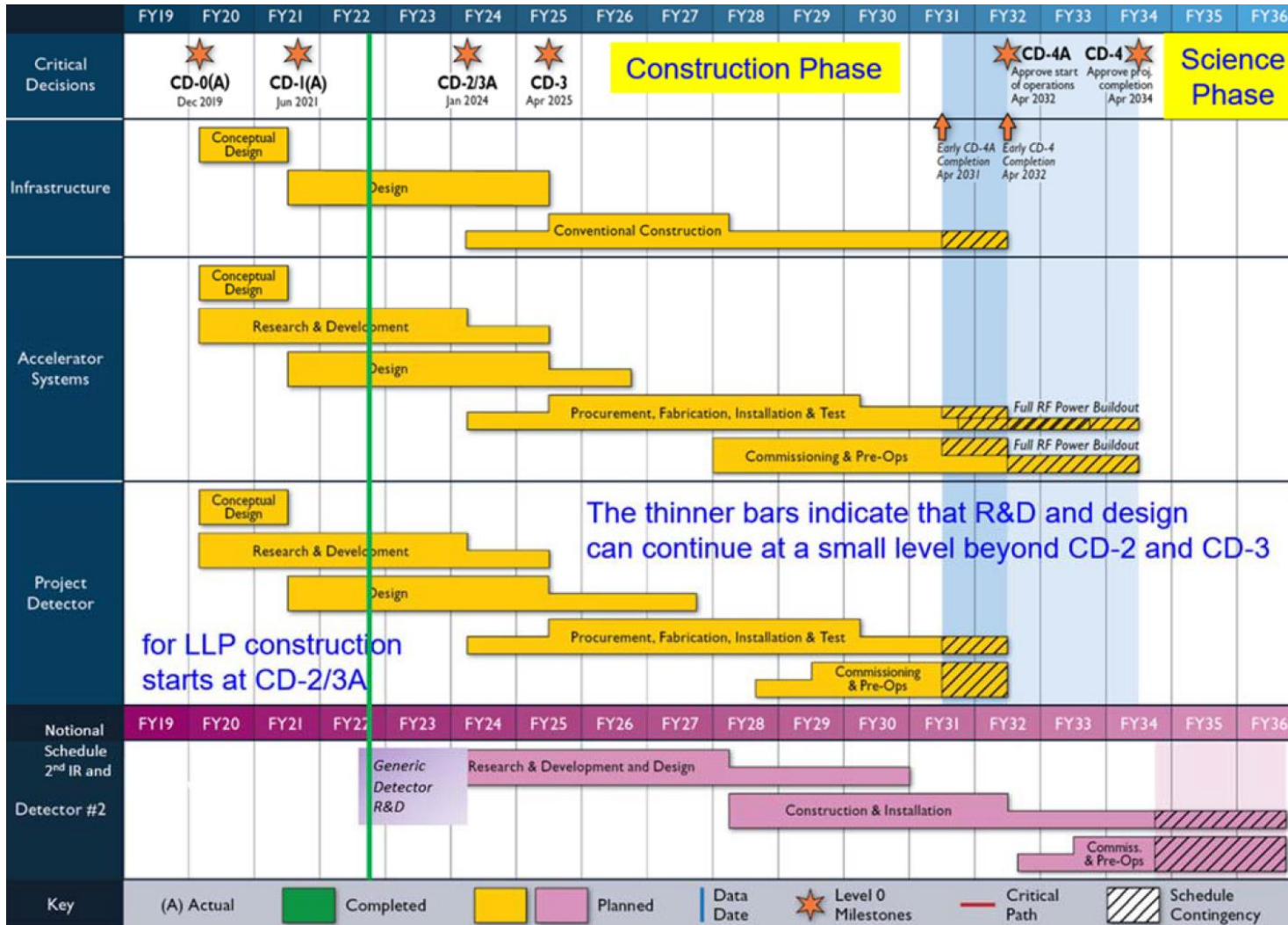

EIC detector milestones

- **Dec 2021:** Detector design
- **Jan 2024:** R&D completed (CD-2)
- **Apr 2025:** TDR completed (CD-3), start of construction
- **2030:** Detector commissioning
- **2031:** Pre-ops
- **2034:** Start of physics program (CD-4)

EIC project cost: budget profile & in-kind contribution

Inflation Reduction Act:
\$138M to Nuclear Physics in FY22 to be spent by FY27.

(IRA funds can ONLY be used for project scope, but NOT to add scope)

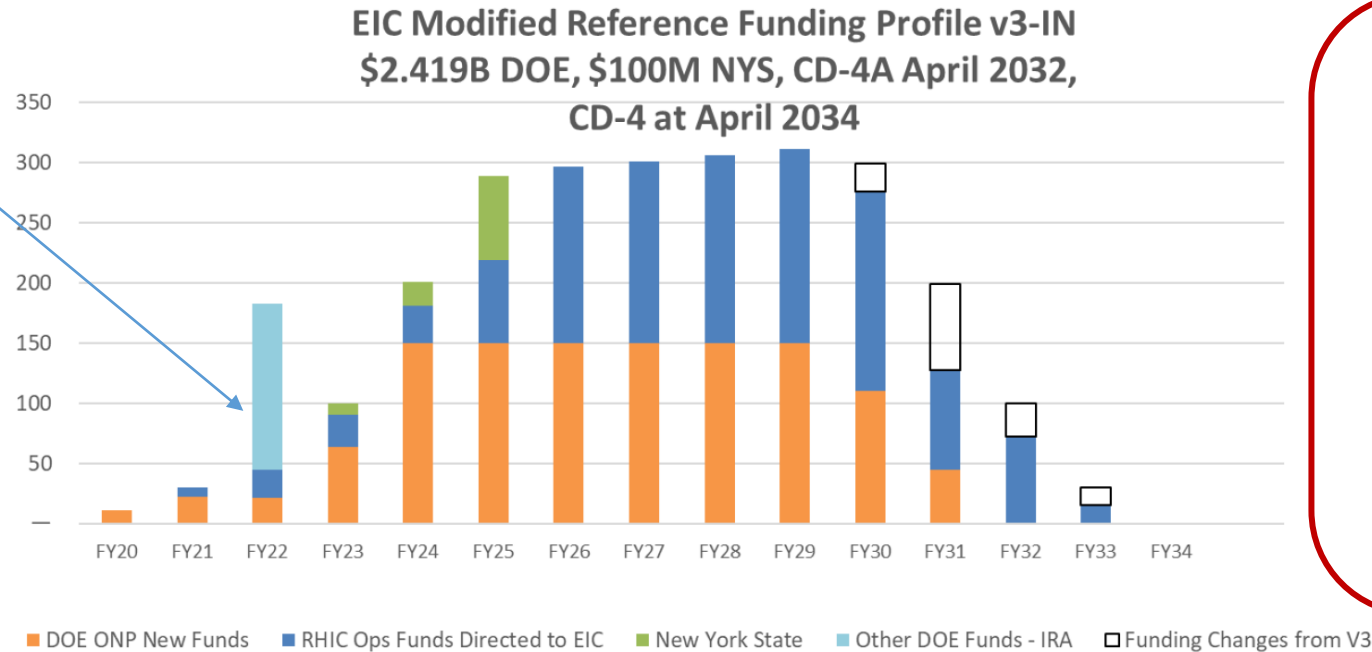

- EIC detector: \$300M (\$200M DoE; \$100 in-kind)
- EIC accelerator: \$1.3B (\$1.25B DoE; \$50 in-kind)
- Other: management (\$200M), infrastructure (\$250M), pre-ops (\$50M), contingency...

- Inflation Reduction Act (IRA) funding is a game changer and mitigates risk of slower than optimum ramp of new funding to the \$150M/year needed.
- Possibility of significant package of long lead procurement items (CD-3A) helping to mitigate and reduce supply chain, schedule, and inflation risks.

Interests of the IJCLab group

Phenomenology and software:

- Development of eA and ep event generators
- Detector simulation and analysis software development

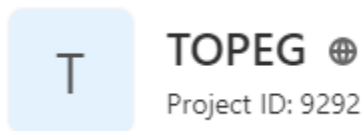

[The Orsay-Perugia Event Generator](#)

$ep \rightarrow e'p'\gamma$

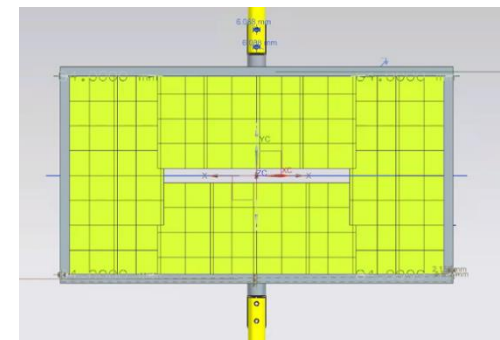
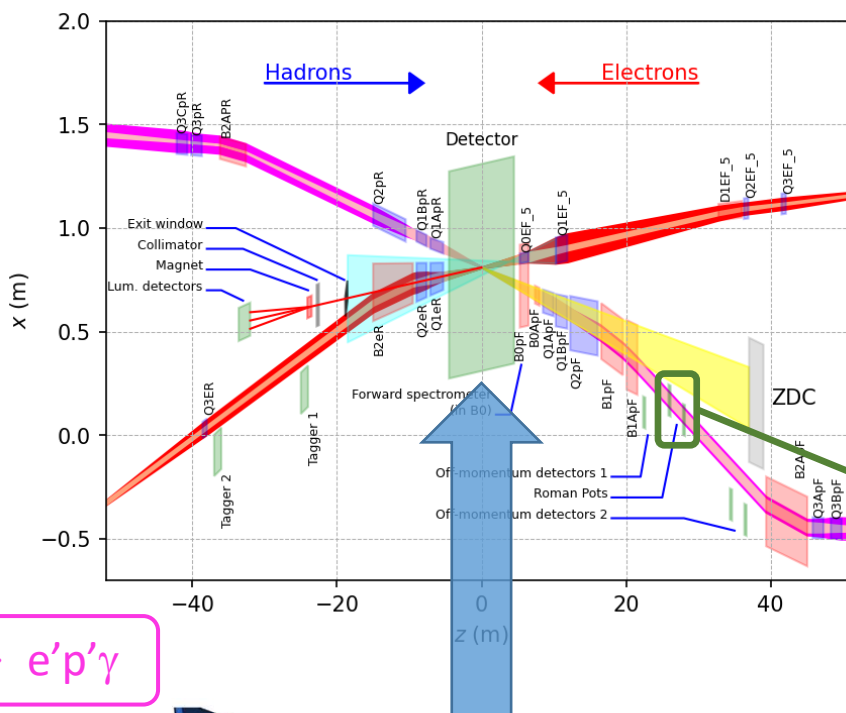

Roman Pots

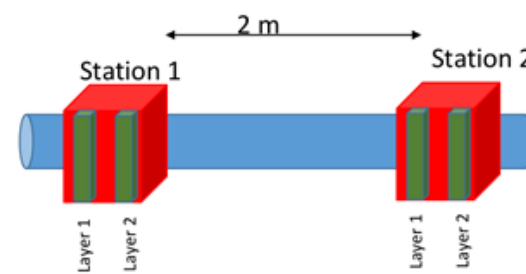

- Roman Pots:**
- AC-LGAD sensors
 - Readout ASIC under development

- EEMCal:**
- PWO crystals
 - SiPM readout

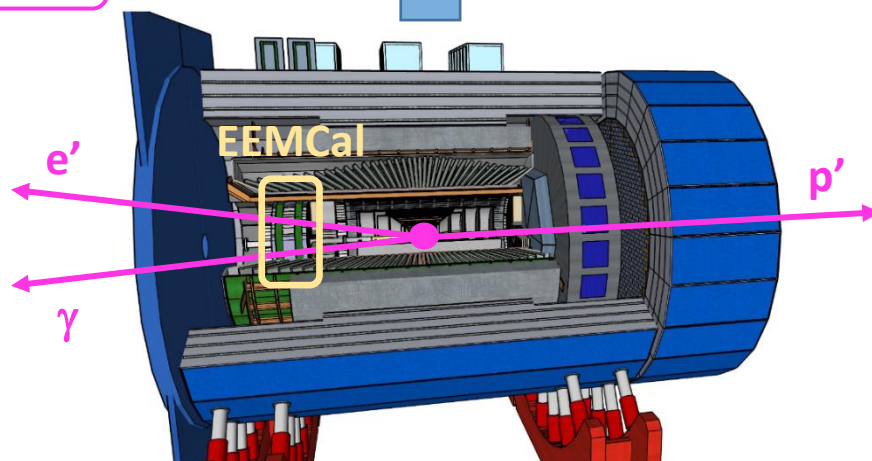

Electron-going endcap ECAL

Electromagnetic (EM) calorimetry is key to any EIC detector concept

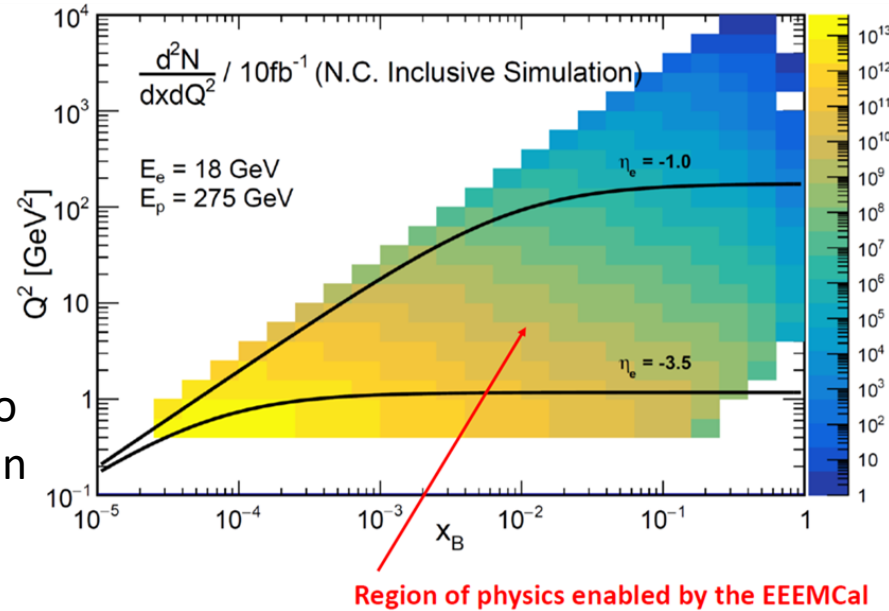

- Almost every channel needs to measured the scattered electron
- EM e-endcap calorimeter :
-3.5 < η < -1

High resolution in the forward region (endcap) can only be achieved with homogeneous materials, such as crystals and glass

- Building on previous experience with EM calorimeters (JLab Hall A PbF_2 , JLab Hall-B PWO IC, JLab Hall-B HPS PWO, PANDA PWO...)
- In synergy with ongoing IJCLab projects for JLab (NPS lead tungsten calorimeter)

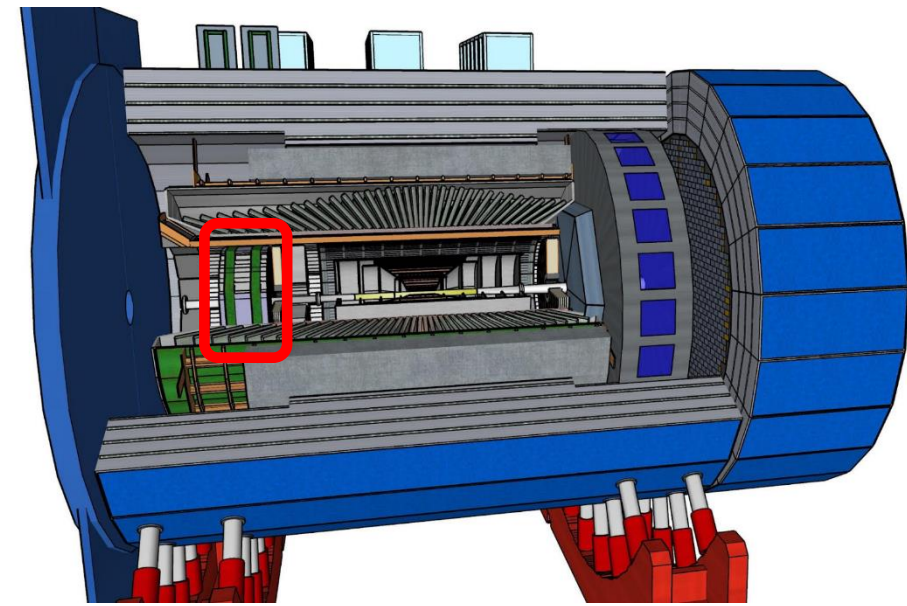

International consortium of 8 institutions:



EEEMCal design

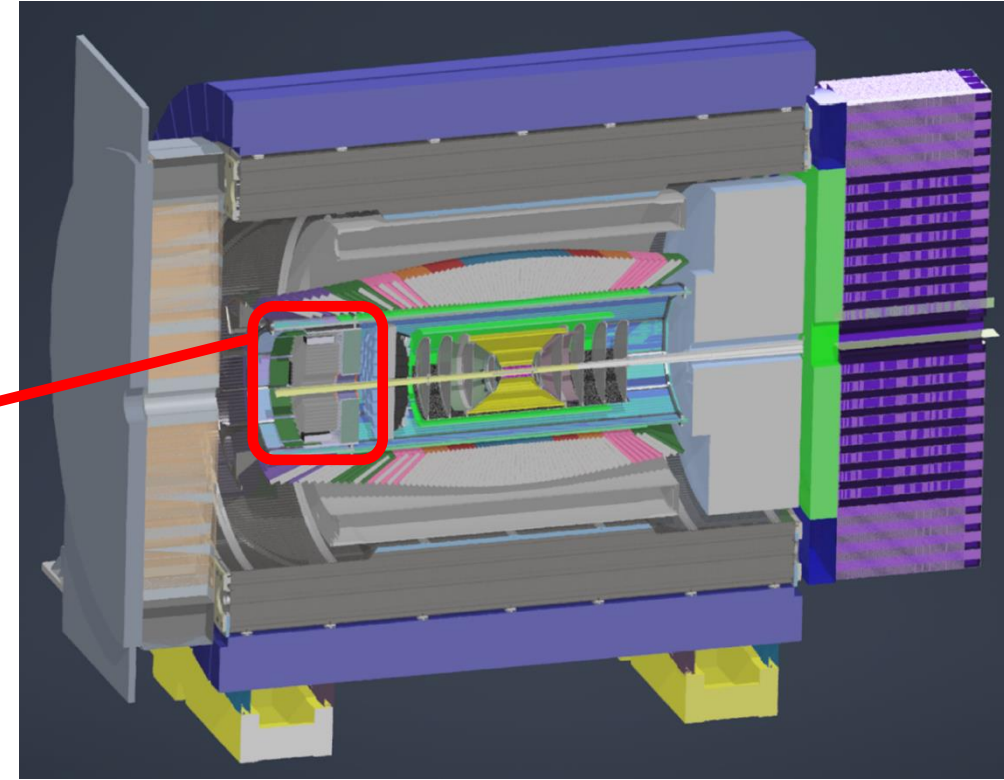
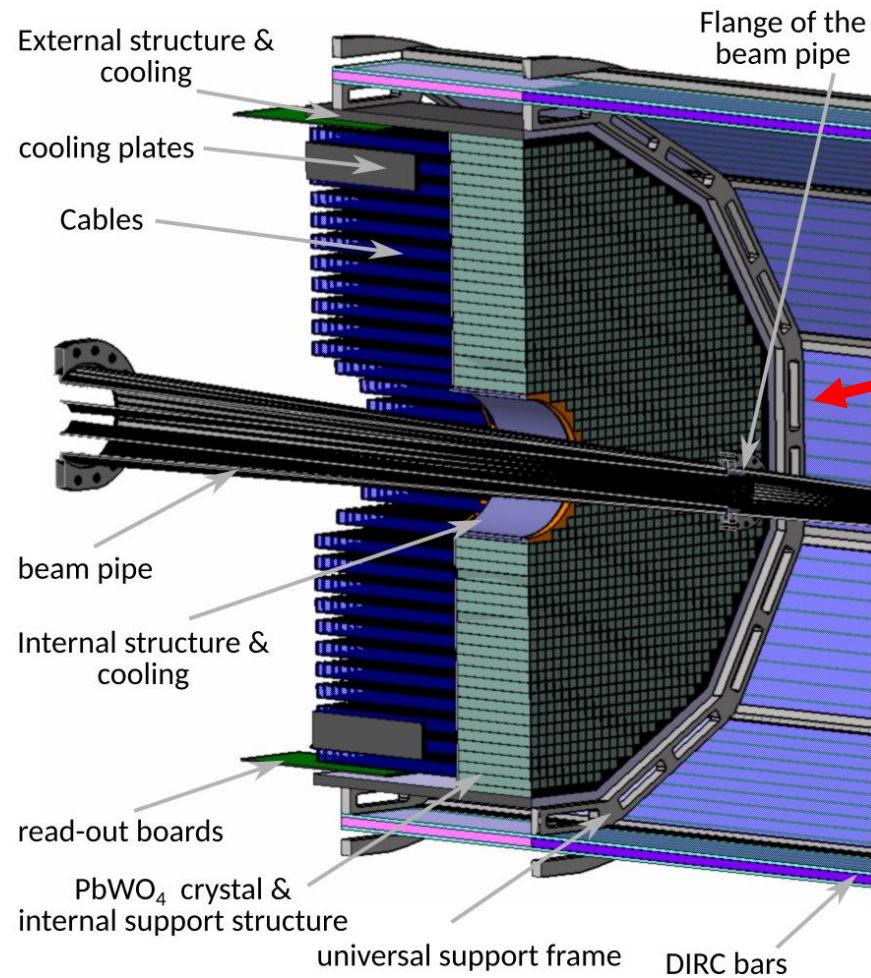

- 2932 lead tungsten crystals
- Scintillating light read out by SiPMs
- Temperature controlled detector (crystals + SiPM): $\pm 0.1^\circ\text{C}$
- Calibration/monitoring system: fibers + laser/LED

Design: département mécanique IJCLab

Lead tungsten (PWO) crystals

- SICCAS manufacturer has poor quality control
- CRYTUR produces high quality crystals, but production capabilities still limited (+ high cost)
- Optical bleaching with blue light validated

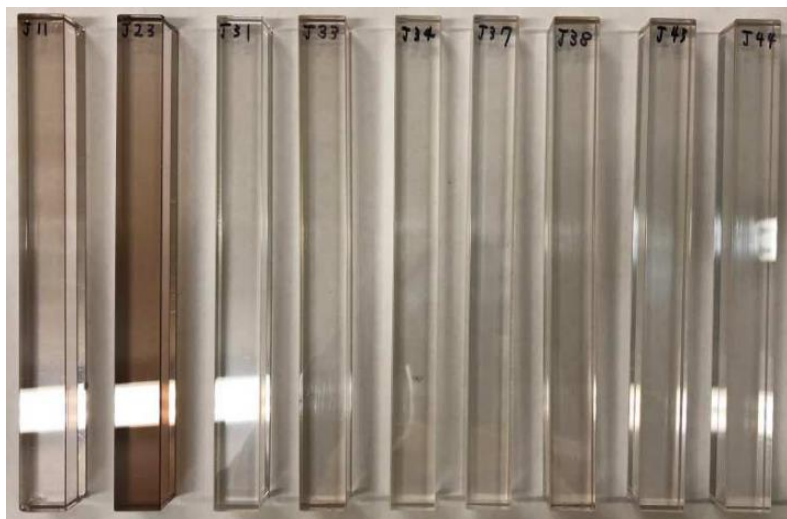

Radiation hardness
(in collaboration with LCP)

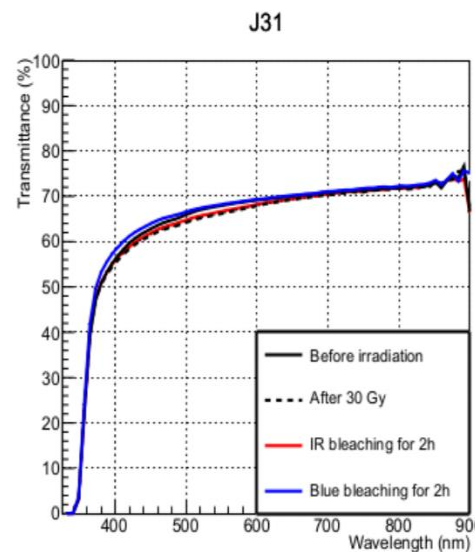
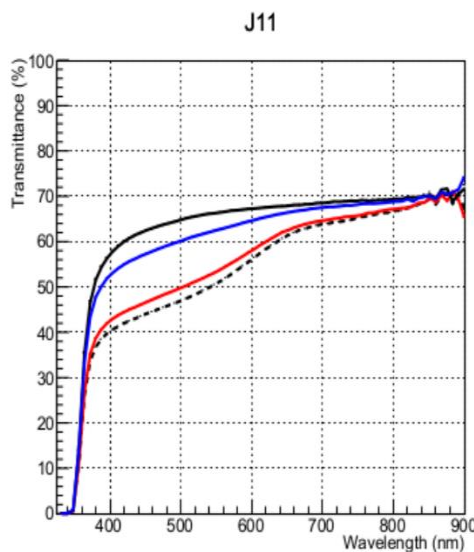
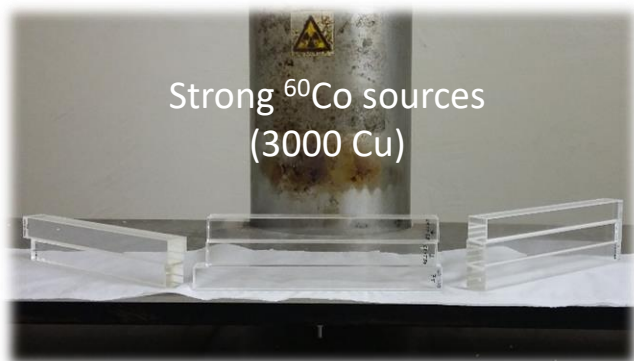

Nucl. Instrum. Meth. A956 (2020) 163375; ArXiv: 1911.11577

SiPM readout

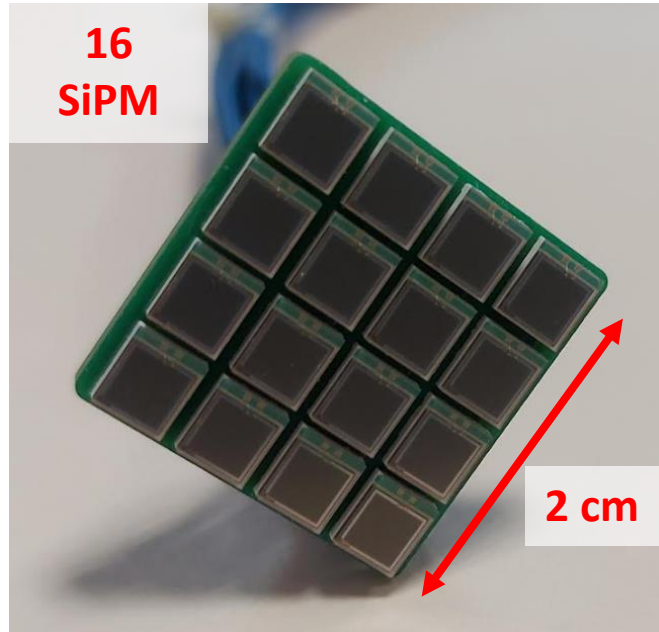

MPPC
S14160-3010PS

HAMAMATSU
PHOTON IS OUR BUSINESS

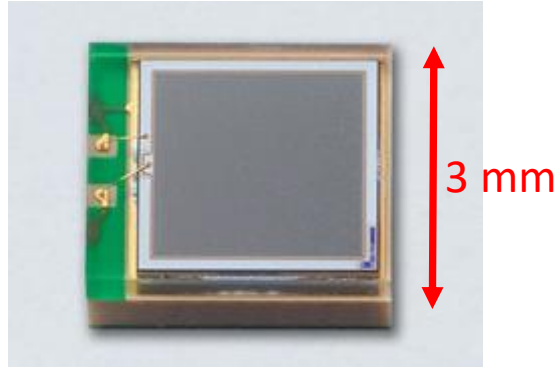

Specifications

Package type	Surface mount type
Number of channels	1 ch
Effective photosensitive area / ch	3 × 3 mm
Number of pixels /ch	89984
Pixel size	10 μm

- With PWO, readout (few p-e) requires analog amplification
- For calorimetry at EIC, large dynamic range needed (~50 MeV – 15 GeV)

Citiroc 1A



Scientific instrumentation SiPM read-out chip

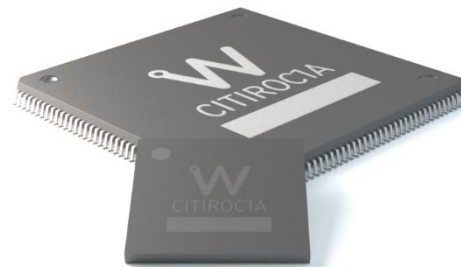

Other option under consideration:

HGCROC

(developed for HGCAL of CMS)



Projet R&T IN2P3 en cours
(2022-2024)

Beam tests: energy resolution

Energy resolution:

$$\frac{\sigma}{E} = A \oplus \frac{B}{\sqrt{E}} \oplus \frac{C}{E}$$

Goal: $A \approx 1\%$, $B \approx 2-3\%$

Geometry, leaks, relative calibration, etc Photo-statistics Electronic noise, etc

The constant term (A) limits the energy resolution at high energy

Factors affecting the constant term:

- Dead material between active modules (eg. crystal supports, air gaps...)
- Control of relative gain (temperature dependence, radiation damage...)
- Calibration, electronic drifts, etc

Optimization by simulation, but ultimately a prototype and a beam test is needed for a realistic estimate

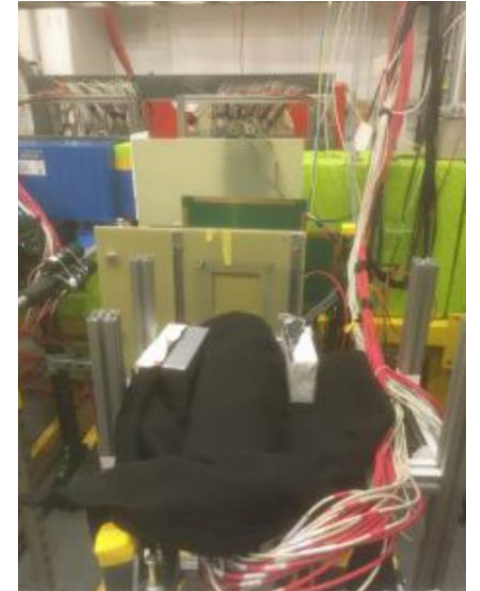

Beam tests possible with photon beam in Hall D at JLab

EIC Roman Pots

- Key detector for exclusive reactions and diffractive processes
- DVCS protons will mostly be detected by the Roman Pots
- Detector requirements:
 - Good timing (~ 30 ps) to reduce momentum smearing due to crabbing
 - Good position (0.5×0.5 mm²) resolution for a p_T resolution < 10 MeV/c
 - Be positioned as close as possible to the beam (“edgeless” detectors)

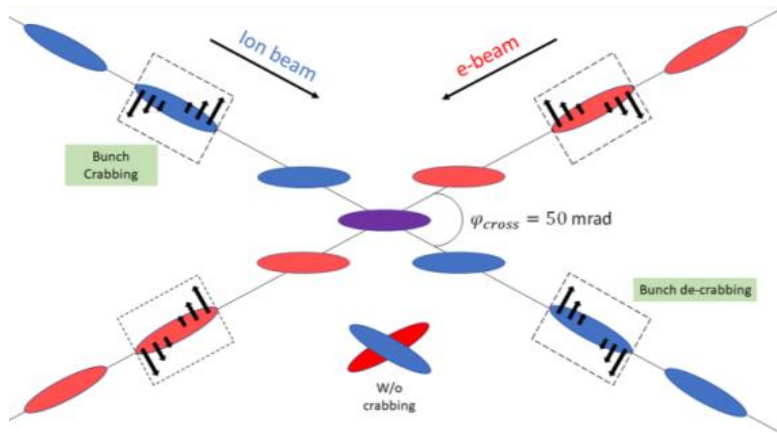
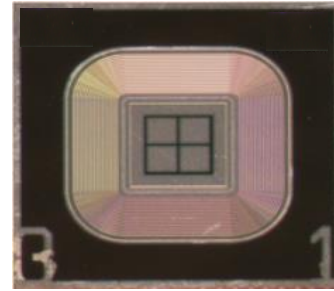
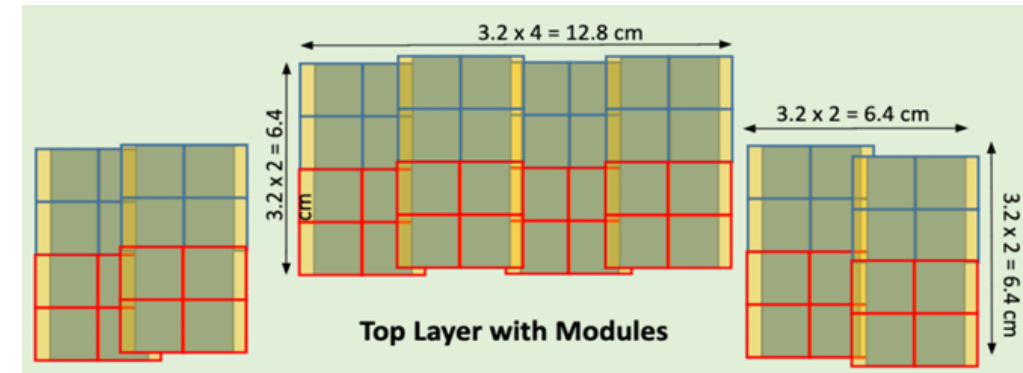
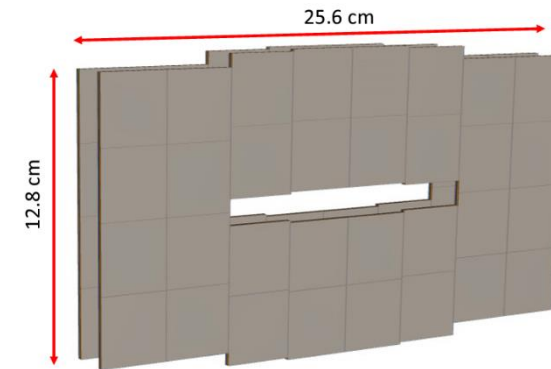
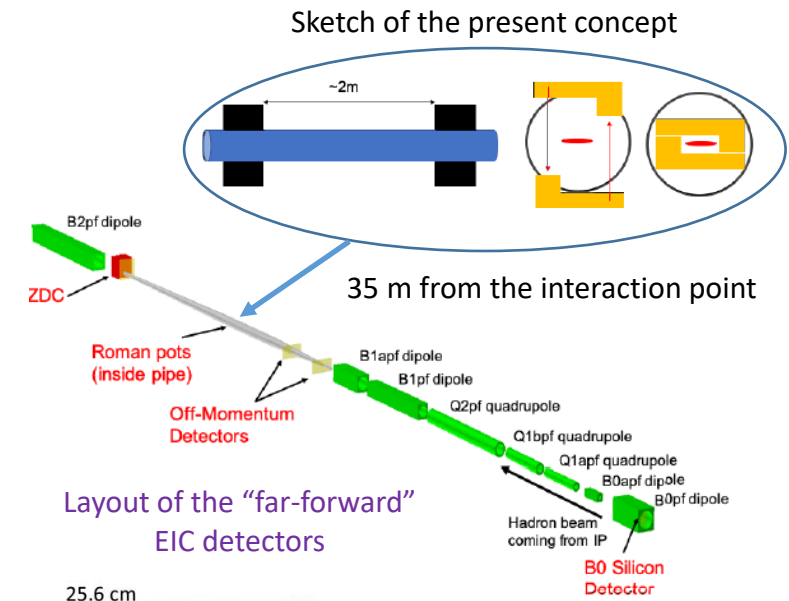

Illustration of crab crossing at EIC



Proposed detector technology:
AC-coupled Low Gain
Avalanche Diodes (LGADs)



LGADs for Roman Pots

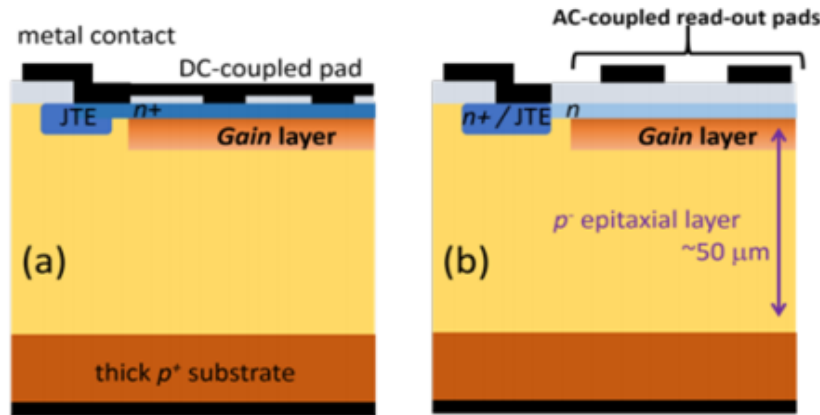

- DC-coupled LGADs used in the upgrades of ATLAS and CMS
- AC-LGADs could provide the required time and position resolutions for the Roman Pots
- Insensitive area (edges) could also be minimized

R&D ongoing at BNL

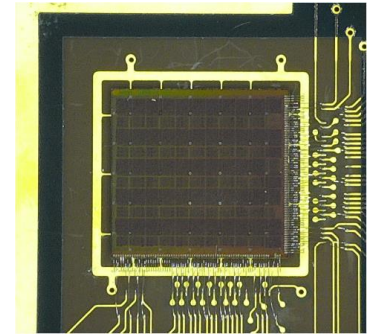

ALTIROC1 chip for ATLAS-HGTD

Readout electronics:

- ASIC for ATLAS-HGTD LGADs developed in part by OMEGA & tested and characterized by IJCLab
- ALTIROC1 chip is a good starting point for a readout of the AC-LGADs for EIC:
 - Smaller pixel size ($0.5 \times 0.5 \text{ mm}^2$ vs. $1.3 \times 1.3 \text{ mm}^2$)
 - Different occupancy rates

Collaboration:



Synergie EIC / ATLAS
au sein du pôle PHE

AC-LGAD readout with ALTIROC

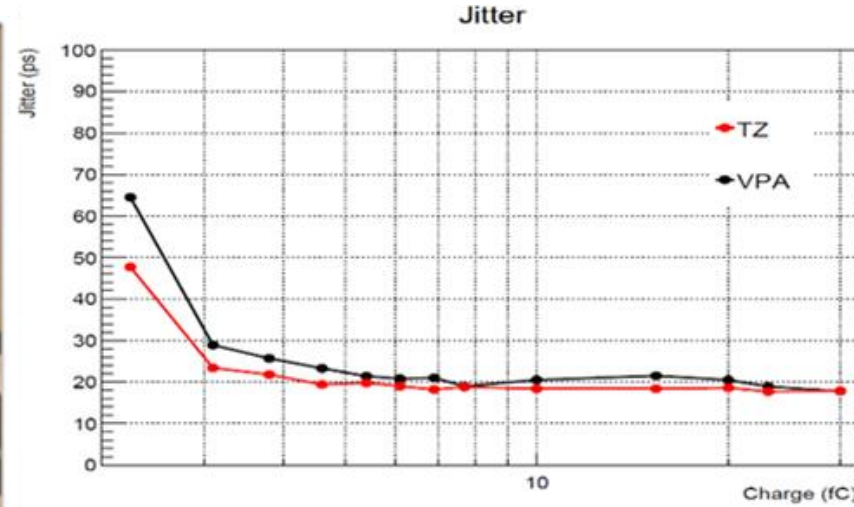
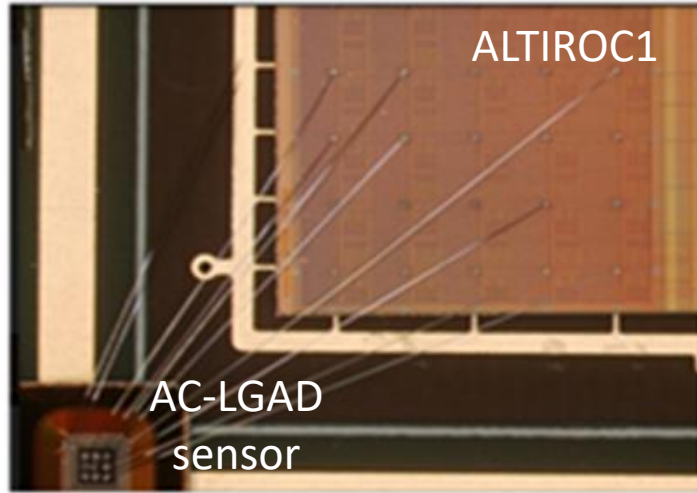

System characterization using β source

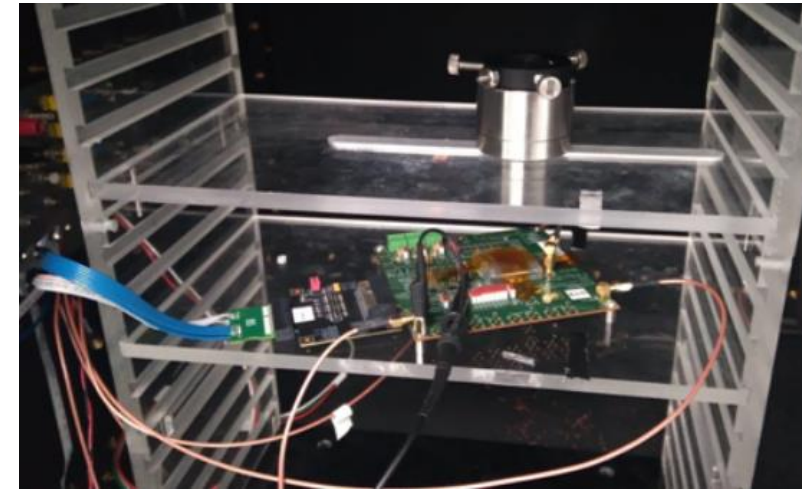

P2IO funding for 2021-2022:

- Characterization of an AC-LGAD with ALTIROC1
- Design and submission of a dedicated ASIC: EICROC0
- Characterization of EICROC0 (*ongoing*)

Projet R&T IN2P3 submitted to continue this R&D (2023-2025)

Signal sharing simulation

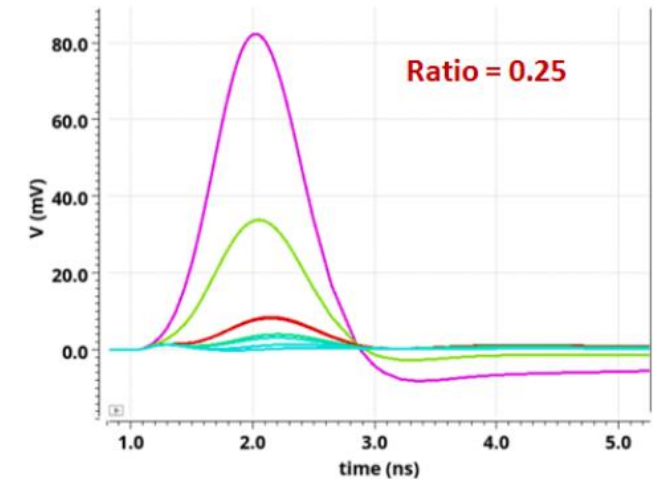
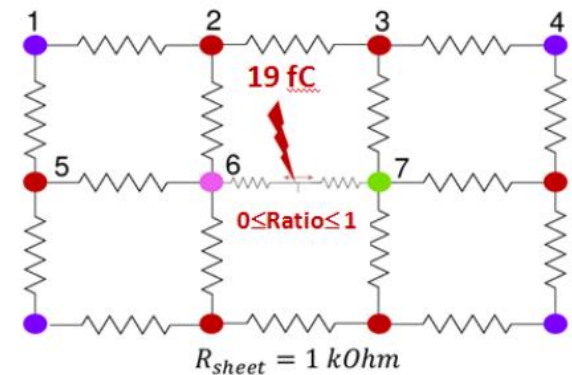

EICROC

EICROC0 (submitted in 3/2022, received in 7/2022) by OMEGA/CEA Irfu/AGH/IJCLab

- 4 x 4 channels
- Preamp, discri. taken from ATLAS ALTIROC
- I2C slow control taken from CMS HGCROC
- TDC (TOA) adapted by CEA-Saclay/Irfu
- ADC (40 MHz) adapted to 8bits by AGH Krakow
- Digital readout: FIFO depth8 (200 ns)

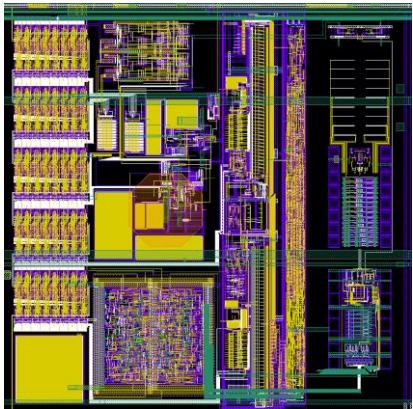

EICROC0,
1 channel
implantation

EICROC0 chip wire-bonded by BNL

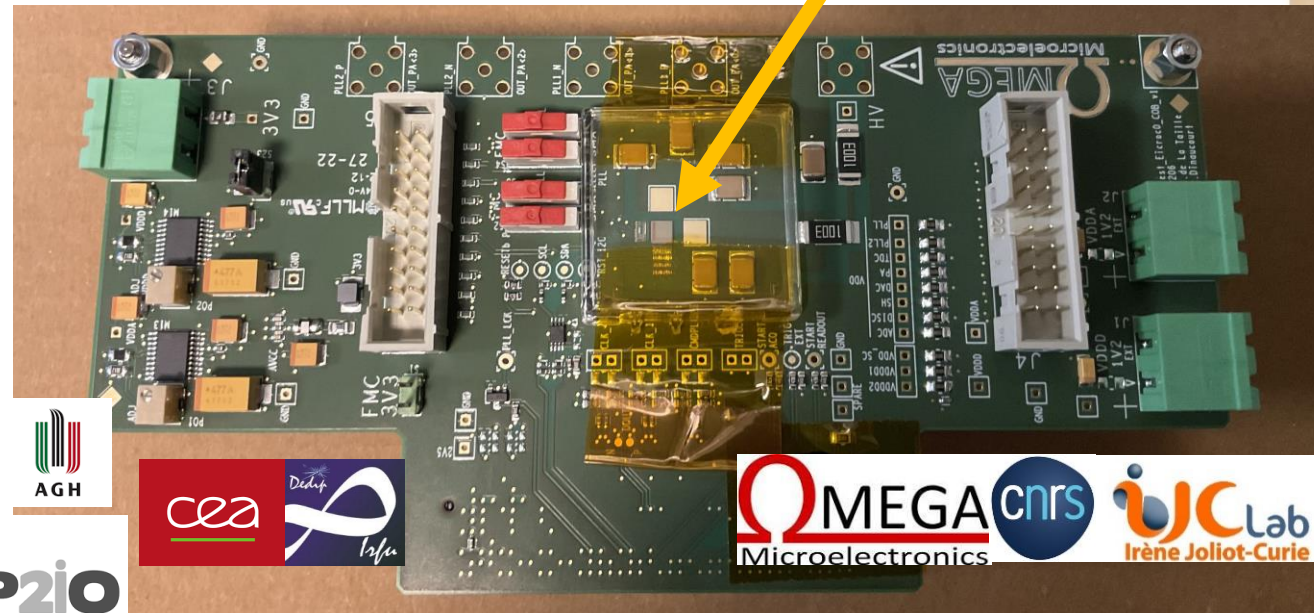
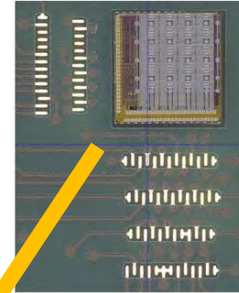

EICROC0 Test bench at 



Simulations and event generators for EIC

- **PYTHIA Quenching Model (PyQM)**

- Pythia based event generator
- Includes quark energy loss from Salgado and Wiedemann
- Includes other basic nuclear effects (Fermi motion...)
- Used for projections on hadronization in previous white papers mostly in connection with quark energy loss in nuclear medium

- **Benchmark eA Generator for Leptonproduction (Beagle)**

- Main general purpose eA generator for EIC maintained by BNL
- Elements of PyQM have been included into Beagle by our group
- Presently pursuing the effort in order to study tagged processes where nuclear fragments of the target are detected
- In particular, how we could evaluate the interaction's centrality
- Widely used for simulations used in the Yellow Report

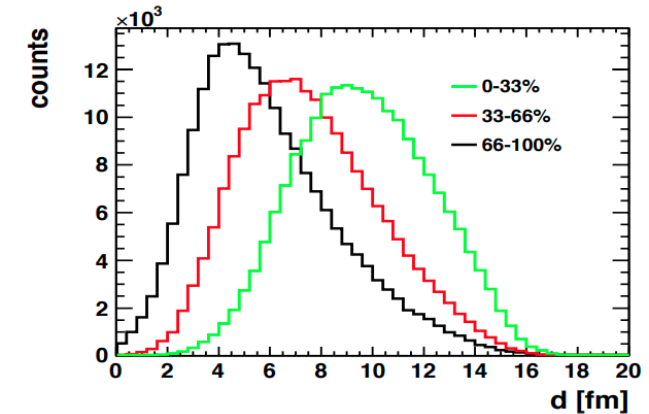
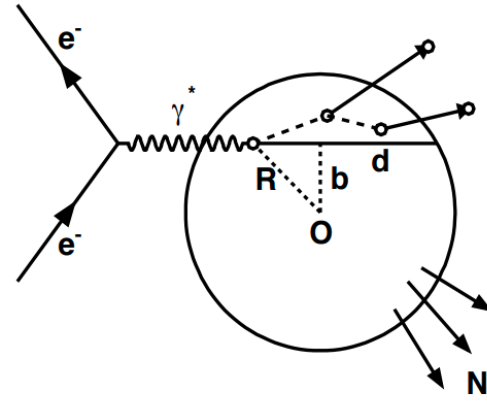

Event Generators for 3D Structure Functions

- **The Orsay-Perugia Event Generator (TOPEG)**

- Nuclear DVCS event generator
- Developed this year specifically for the Yellow Report
- More developments to come for applications at JLab (PartonicNucleus project) and EIC (inclusion of shadowing)

- **Project for a nuclear TMD event generator**

- Initially aimed for JLab energies to support JLab experiments
- One of the components of the PartonicNucleus project
- Will be developed with future applications at EIC largely in mind
- The goal is to offer a new perspective on hadronization studies by fully accounting for the transverse momentum components

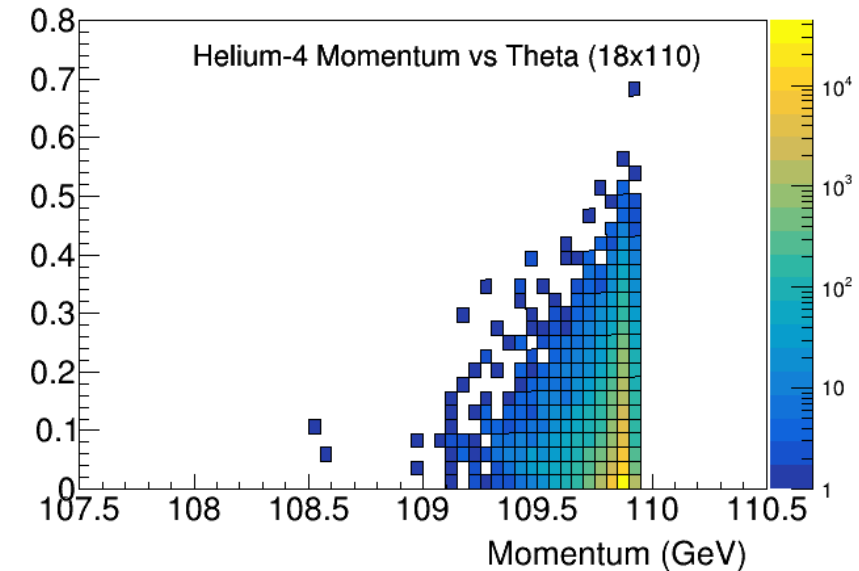

National perspective

- Strong experimental interest from IJCLab and Irfu/CEA
- Large theory interest from many groups: IN2P3+INP (CNRS) & IPhT (CEA)
- Featured in several funded projects:
 - STRONG 2020 (EU)
 - Gluodynamics (P2IO)
- Discussed within the 'Exercise de prospective nationale' (GT03)
 - EIC contribution submitted:
 - 26 permanent staff (9 theory, 13 experiment, 4 IT & Accelerator)
 - 8 different labs (3 theory, 5 experiment)
 - EIC will appear among the recommendations of the report

Exciting opportunities for involvement in
detector and accelerator R&D (and construction)
in the next few years

Strong synergy with theory activity in France

- Our physics interests have a large overlap with theory activities at France (IN2P3, INP, CEA)
- Field of GPDs has had strong contributions by French theorists from the start
- Theory interests include:
 - Saturation physics
 - GPDs (through DVCS, DVMP and other processes)
 - TMDs (gluon TMDs in particular)
 - Nuclear PDFs
 - Quarkonia

Summary

- The EIC facility will address fundamental questions on the structure and dynamics of nucleons and nuclei in terms of quarks and gluons, using precision measurements including:

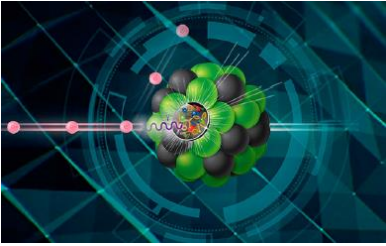

- Parton distributions in nuclei/QCD at extreme parton densities – saturation
- Spin and flavor structure of the nucleon and nuclei
- Tomography (p/A) Transverse Momentum Distributions and Spatial Imaging

- The EIC will be built at BNL by adding an electron storage ring to the existing RHIC facility

- Luminosity: $\sim 10^{33-34} \text{ cm}^{-2}\text{s}^{-1}$
- Polarized e/p and unpolarized heavy ion beams/ CME $\sim 20-140 \text{ GeV}$

- We propose to continue and significantly increase our involvement and contribution towards the realization of the EIC:

- Continuation of software and simulation development
- Technical contribution to the EM calorimeter for the electron endcap
- Readout electronics for the Roman Pots

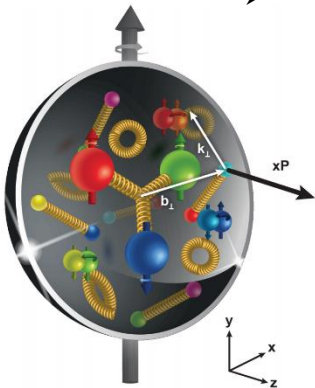

Back-up

Avis des CS précédents

➤ Conseil scientifique IPNO, July 2017

- Le CS félicite le groupe de s'impliquer dès maintenant dans une activité à long terme sur EIC, projet de **machine au niveau mondial pour la physique hadronique**.
- Le groupe de l'IPNO a tous les atouts pour **jouer un rôle leader** en France.

➤ Conseil scientifique IN2P3, Feb. 2018

- Le groupe de l'IPNO affiche d'ores et déjà son intérêt et participe activement au développement de ce projet. Le conseil note que l'IRFU est aujourd'hui plus clairement engagé dans l'EIC que l'IN2P3.
- Un engagement dans l'un des deux au moins, l'EIC et/ou FAIR, **est indispensable à l'avenir de la physique hadronique en France**, en complément de ce qui se fera auprès du LHC.

➤ Conseil scientifique IJCLab, Nov. 2020

- A joint PhD thesis (typically, hardware in EIC and data analysis in JLab) is a good idea today.
- The **calorimeter project** has relatively moderate risk: there is a strong need of a calorimeter in the backward. This will thus **ensure a visible contribution of the EIC-IJCLab group in one important sub-detector**.
- The **Roman pots** part is riskier since there is no guarantee that a viable ASIC can be developed for this solution. If it works, **it will also be a very visible contribution**.

EEEMCal cost

Total cost: \$9.1M

- **\$7.1M Materials:**
\$5.5M project + \$1.6M in-kind
- **\$2.0M Labor (36249 h):**
\$0.3M project + \$1.7M in-kind

Labor Skill Set	Cost per hour for each skill set	Cost of 1FTE/year
Scientist	\$157	\$276,408
PostDoc	\$71	\$124,942
PhD Student	\$20	\$35,200
Undergrad	\$20	\$35,200
Mechanical Engineer	\$153	\$269,579
Mechanical Designer	\$116	\$204,336
Mechanical Tech	\$101	\$177,778
Electrical Engineer	\$153	\$269,579
Electrical Designer	\$116	\$204,336
Electrical Tech	\$101	\$177,778
Software Expert	\$178	\$313,702
Other	\$0	\$0

Activity Description (Separate between conceptual design, preliminary design, final design, long lead procurements etc.)	Activity Type (Pull Down)	Units	Unit Pricing	Direct Materials Total \$\$ (Calculated)	Basis of Estimate for costing (Pull Down)	Labor Hours	Resource Name (Pull Down)	Funding Source (Pull Down)
Prototyping and Preliminary Design								
Prototyping and preliminary design	Preliminary Design	1	\$60,000.00	\$60,000	Historical Costs		Other	In-Kind
Prototyping and preliminary design	Preliminary Design				Historical Costs	1998	PostDoc	In-Kind
Prototyping and preliminary design	Preliminary Design				Historical Costs	896	PhD Student	In-Kind
Prototyping and preliminary design	Preliminary Design				Historical Costs	225	Undergrad	In-Kind
Design Review	Preliminary Design				Expert Opinion	80	Mechanical Engineer	In-Kind
Detailed Design Mechanics and Integration								
Detailed design Mechanics and integration	Final Design	1	\$60,000.00	\$60,000	Historical Costs		Other	Project/In-Kind
Detailed design Mechanics and integration	Final Design				Historical Costs	980	Mechanical Designer	Project/In-Kind
Detailed design Mechanics and integration	Final Design				Historical Costs	200	Mechanical Engineer	In-Kind
Detailed design of Electronics	Final Design				Historical Costs	370	Electrical Engineer	In-Kind
Design Review and Procurement Readiness Review								
Material procurement								
Procure PWO (2x2x20) material	Procurement of Material	2540	\$1,850.00	\$4,699,000	Vendor Quote		Other	Project
Procure PWO (2x2x20) material	Procurement of Material	358	\$1,850.00	\$662,300	Historical Costs		Other	Repurpose
Procure PWO (2x2x20) material	Procurement of Material	358	\$1,850.00	\$662,300	Historical Costs		Other	In-Kind
Pack&Ship	Procurement of Material	3256	\$2.80	\$9,117	Historical Costs		Other	Project
Scintillator wrapping material (VM2000)	Procurement of Material	3667	\$10.00	\$36,670	Historical Costs		Other	Project
Procure photosensors S141-3015PS	Procurement of Material	52096	\$10.00	\$520,960	Vendor Quote		Other	Project
Procure photosensor mounting boards	Procurement of Material	3256	\$10.00	\$32,560	Historical Costs		Other	Project
Procure Detector Mechanical Components, Machining, Fabrication:								
Carbon structure and plates	Procurement of Material	1	\$17,900.00	\$17,900	Historical Costs		Other	In-Kind
Aluminum frame	Procurement of Material	1	\$10,100.00	\$10,100	Historical Costs		Other	In-Kind
Support plates	Procurement of Material	1	\$5,800.00	\$5,800	Historical Costs		Other	In-Kind
Cooling plates	Procurement of Material	1	\$44,300.00	\$44,300	Historical Costs		Other	In-Kind
Light Monitoring system	Procurement of Material	1	\$30,000.00	\$30,000	Historical Costs		Other	In-Kind
Temperature control system (chiller and fans, etc.)	Procurement of Material	1	\$50,000.00	\$50,000	Historical Costs		Other	In-Kind
Assembly tools, screws, nuts, bolts, etc.	Procurement of Material	1	\$11,600.00	\$11,600	Historical Costs		Other	In-Kind
Mock-up components	Procurement of Material	1	\$4,300.00	\$4,300	Historical Costs		Other	In-Kind
Material delivery								
Setup factory for assembly, QA, testing								
Setup factory for assembly, QA, testing	In House Assembly	1	\$186,800.00	\$186,800	Historical Costs		Other	Project
Assembly and Production:								
Quality control and assembly detector components	Q&A / Testing				Historical Costs	4000	PostDoc	In-Kind
Quality control and assembly detector components	Q&A / Testing				Historical Costs	2600	PhD Student	In-Kind
Quality control and assembly detector components	Q&A / Testing				Historical Costs	1200	Undergrad	In-Kind
Refurbish PWO (2x2x20) material	Q&A / Testing				Historical Costs	1000	PhD Student	In-Kind
Refurbish PWO (2x2x20) material	Q&A / Testing				Historical Costs	2000	PostDoc	In-Kind
Rework components that did not pass quality control	Other				Historical Costs	2000	PostDoc	In-Kind
Rework components that did not pass quality control	Other				Historical Costs	1000	PhD Student	In-Kind
Performance studies detector components	Q&A / Testing				Historical Costs	2000	Undergrad	In-Kind
Performance studies detector components	Q&A / Testing				Historical Costs	2600	PhD Student	In-Kind
Performance studies detector components	Q&A / Testing				Historical Costs	4000	PostDoc	In-Kind
Integration in major support frame	Installation				Historical Costs	3900	PostDoc	In-Kind
Integration in major support frame	Installation				Historical Costs	2600	PhD Student	In-Kind
Integration in major support frame	Installation				Historical Costs	1000	Undergrad	In-Kind
Integration in major support frame	Installation				Historical Costs	1600	Mechanical Tech	Project/In-Kind

Roman Pots cost

Total cost: \$0.96M

- **\$0.30M Materials:**
\$0.300M project + \$0.002M in-kind
- **\$0.66M Labor (6500 h):**
\$0.59M project + \$0.07M in-kind

Roman Pots (RP)													
Prototype design AC-LGAD sensors	Prototype design AC-LGAD sensors			Expert Opinion	80	Electrical Engineer	Project	100	0	\$0	\$12,254	\$12,254	\$0
Prototype design AC-LGAD sensors	Prototype design AC-LGAD s	2	\$1,000.00	Expert Opinion		Other	Project	100	0	\$2,000	\$0	\$2,000	\$0
Read out ASIC design	Read out ASIC design			Expert Opinion	80	Electrical Engineer	Project	100	0	\$0	\$12,254	\$12,254	\$0
Read out ASIC design	Read out ASIC design	1	\$1,000.00	Expert Opinion		Other	Project	100	0	\$1,000	\$0	\$1,000	\$0
Mechanical frame design	Mechanical frame design			Expert Opinion	600	Mechanical Designer	Project/In-Kind	10	90	\$0	\$69,660	\$6,966	\$62,694
Mechanical frame design	Preliminary Design	1	\$500.00	Expert Opinion		Other	Project	100	0	\$500	\$0	\$500	\$0
Prototype assembly	In House Fabrication			Expert Opinion	100	Mechanical Tech	Project	100	0	\$0	\$10,101	\$10,101	\$0
Prototype assembly	In House Fabrication	1	\$500.00	Expert Opinion		Other	Project	100	0	\$500	\$0	\$500	\$0
Pot Vacuum and mechanics	Preliminary Design			Expert Opinion	600	Mechanical Engineer	Project	100	0	\$0	\$91,902	\$91,902	\$0
pot prototype assembly	Preliminary Design			Expert Opinion	200	Mechanical Tech	Project	100	0	\$0	\$20,202	\$20,202	\$0
pot prototype assembly	Preliminary Design	1	\$3,000.00	Expert Opinion		Other	Project	100	0	\$3,000	\$0	\$3,000	\$0
Pot Vacuum and mechanics	Final Design			Expert Opinion	200	Electrical Designer	Project	100	0	\$0	\$23,220	\$23,220	\$0
Pot construction	In House Assembly			Expert Opinion	200	Mechanical Tech	Project	100	0	\$0	\$20,202	\$20,202	\$0
Pot construction	In House Assembly	4	\$3,000.00	Expert Opinion		Other	Project	100	0	\$12,000	\$0	\$12,000	\$0
Cooling system design	Preliminary Design			Expert Opinion	50	Mechanical Designer	Project/In-Kind	50	50	\$0	\$5,805	\$2,903	\$2,903
Cooling system design	Preliminary Design	1	\$2,000.00	Expert Opinion		Other	Project/In-Kind	50	50	\$2,000	\$0	\$1,000	\$1,000
Cooling prototype production	Procurement of Material			Expert Opinion	0	Other	Project	100	0	\$0	\$0	\$0	\$0
Cooling prototype production	Procurement of Material	1	\$1,000.00	Expert Opinion		Other	Project	100	0	\$1,000	\$0	\$1,000	\$0
Cooling prototype testing	In House Assembly			Expert Opinion	80	PhD Student	Project	100	0	\$0	\$1,600	\$1,600	\$0
Cooling prototype testing	In House Assembly	1	\$500.00	Expert Opinion		Other	Project	100	0	\$500	\$0	\$500	\$0
cooling Final design	Final Design			Expert Opinion	50	Mechanical Designer	Project/In-Kind	50	50	\$0	\$5,805	\$2,903	\$2,903
Cooling Final design	Final Design	1	\$2,000.00	Expert Opinion		Other	Project/In-Kind	50	50	\$2,000	\$0	\$1,000	\$1,000
Roman Pots Procurement of Materials (Silicon & Ascics)	Procurement of Material	150	\$290.00	Expert Opinion		Other	Project	100	0	\$43,500	\$0	\$43,500	\$0
Roman Pots Procurement of Materials (Silicon & Ascics)	Procurement of Material	600	\$300.00	Expert Opinion		Other	Project	100	0	\$180,000	\$0	\$180,000	\$0
Assembly of PRs planes	In House Assembly			Expert Opinion	80	PostDoc	Project	100	0	\$0	\$5,679	\$5,679	\$0
Silicon and ASICS testing	In House Assembly			Expert Opinion	880	Electrical Tech	Project	100	0	\$0	\$88,889	\$88,889	\$0
Assembly of Sensors and ASICS	In House Assembly			Expert Opinion	880	Electrical Tech	Project	100	0	\$0	\$88,889	\$88,889	\$0
Assembly of PRs planes	In House Assembly			Expert Opinion	40	Electrical Tech	Project	100	0	\$0	\$4,040	\$4,040	\$0
Assembly of PRs planes	In House Assembly			Expert Opinion	160	PhD Student	Project	100	0	\$0	\$3,200	\$3,200	\$0
Assembly of RPs planes	In House Assembly			Expert Opinion	160	Undergrad	Project	100	0	\$0	\$3,200	\$3,200	\$0
Peripheral electronics boards	Procurement of Material	1	20000	Expert Opinion		Other	Project	100	0	\$20,000	\$0	\$20,000	\$0
Cables, electronical connectors, LV/HV cables	Procurement of Material	1	30000	Expert Opinion	160	Undergrad	Project	100	0	\$30,000	\$3,200	\$33,200	\$0
Cooling Temperature Sensors	Procurement of Material			Expert Opinion	0	Other	Project	100	0	\$0	\$0	\$0	\$0
Cooling Temperature Sensors	Procurement of Material	40	\$50.00	Expert Opinion		Other	Project	100	0	\$2,000	\$0	\$2,000	\$0
Cooling Compressed air pipes	Procurement of Material			Expert Opinion	0	Other	Project	100	0	\$0	\$0	\$0	\$0
Cooling Compressed air pipes	Procurement of Material	8	\$50.00	Expert Opinion		Other	Project	100	0	\$400	\$0	\$400	\$0
Cables	Procurement of Material			Expert Opinion	0	Other	Project	100	0	\$0	\$0	\$0	\$0
Cables	Procurement of Material	40	\$25.00	Expert Opinion		Other	Project	100	0	\$1,000	\$0	\$1,000	\$0
Mechanical support	Procurement of Material			Expert Opinion	0	Other	Project	100	0	\$0	\$0	\$0	\$0
Mechanical support	Procurement of Material	4	\$500.00	Expert Opinion		Other	Project	100	0	\$2,000	\$0	\$2,000	\$0
Assembly of cooling frames	In House Assembly			Expert Opinion	100	Mechanical Tech	Project	100	0	\$0	\$10,101	\$10,101	\$0
Full RP system assembly	In House Assembly			Expert Opinion	880	Mechanical Tech	Project	100	0	\$0	\$88,889	\$88,889	\$0
Full RP system assembly	In House Assembly			Expert Opinion	880	Electrical Tech	Project	100	0	\$0	\$88,889	\$88,889	\$0
Assembly of cooling frames	In House Assembly	2	\$100.00	Expert Opinion		Other	Project	100	0	\$200	\$0	\$200	\$0
Assembly of cooling frames	In House Assembly			Expert Opinion	40	PhD Student	Project	100	0	\$0	\$800	\$800	\$0
POT/mechanical assembly and moving stages	Procurement of Material	2	\$100,000.00	Expert Opinion		Other	Project	100	0	\$200,000	\$0	\$200,000	\$0
					6500						\$303,600	\$658,780	\$70,499