

GRAiNITA status report

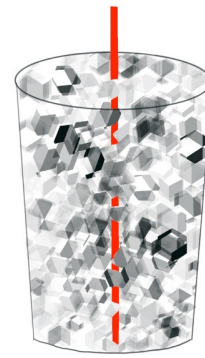

S. Barsuk¹, D. Breton¹, A. Boyarintsev², I. Boyarintseva^{2,1}, H. Chanal³, A. M. Dubovik², G. Hull¹, A.Kotenko⁴, J. Lefrancois¹, S. Monteil³, M-H Schune¹, N.Semkiv⁴, I. Tupitsyna², M. Yeresko³

¹ *Université Paris-Saclay, CNRS-IN2P3, IJCLab, Orsay, France*

² *Institute of Scintillation Materials of the National Academy of Science of Ukraine, Kharkiv, Ukraine*

³ *Université Blaise Pascal, CNRS-IN2P3, LP-Clermont, Aubiere, France*

⁴ *Kyiv National Taras Shevchenko University Ukraine*

The overall idea (in a nutshell)

Inspired by LiquidO technique for neutrino detector
(A. Cabrera et al. LiquidO Commun Phys 4, 273 (2021))

Typical sampling calorimeters:

$$\frac{\sigma_E}{E} \sim \frac{10\% - 15\%}{\sqrt{E}}$$

Requirements:

- fine sampling
- scintillation light locally contained

Crystal calorimeters :

$$\frac{\sigma_E}{E} \sim \frac{1\% - 2\%}{\sqrt{E}}$$

Shashlyk-type calorimeter

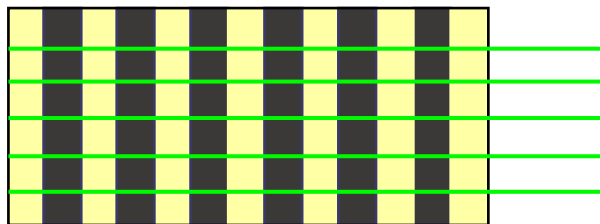

GRAiNITA

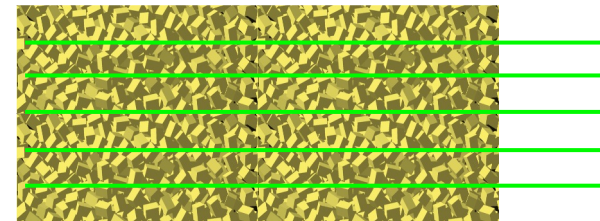

ZnWO₄

ZnWO₄ possible candidat:

- LY= 10kph/MeV
- Density 7.62
- Index n=2.1
- $\tau = 20 \mu\text{s}$
- $\lambda_{\text{max}} = 480 \text{ nm}$
- grain size : 0.5 mm - 1 mm

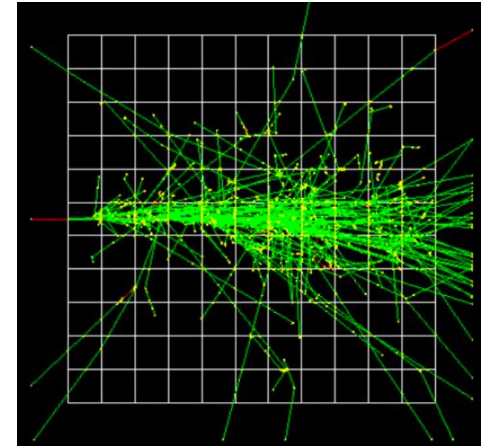
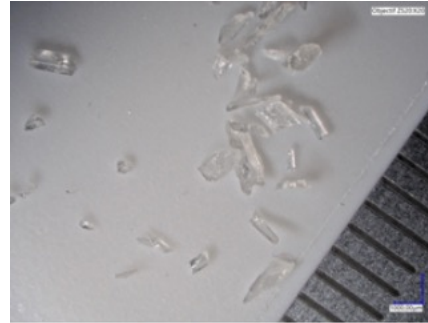

GEANT4 simulation
ZnWO4 + CH2I2 cubes
(random position)

$$1\text{mm cubes } \frac{\sigma_E}{E} \sim \frac{2\%}{\sqrt{E}}$$

ISMA has done specific R&D and has produced grains & plates of ZnWO₄

At hand:

- ~ 1kg of ZnWO₄
- grains of BGO (200 g)
- small plates of BGO & of ZnWO₄

^{241}Am spectra for ZnWO_4 grains

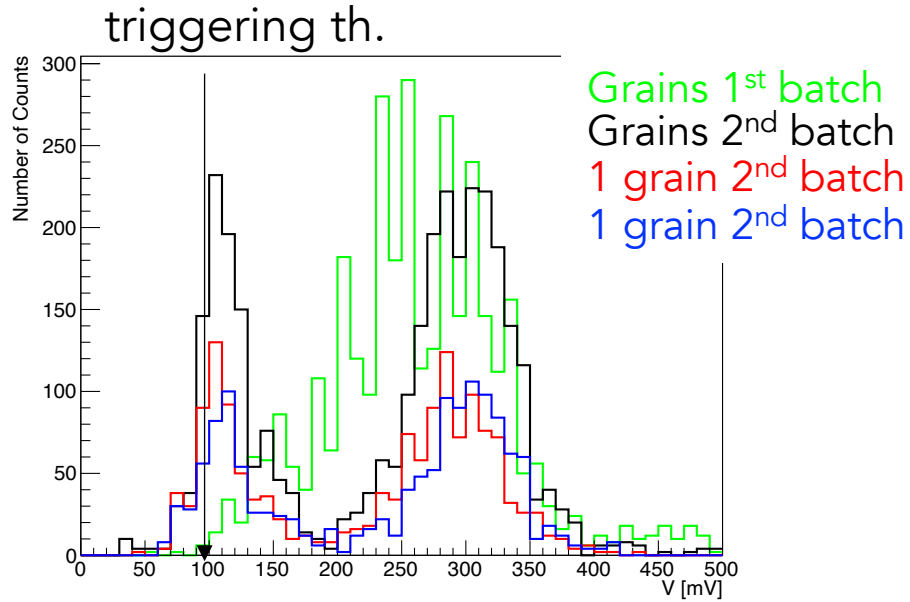

Better homogeneity in the grains light yield of the second production

Production under control:

- grains are similar to larger crystals
- homogenous production

Crystals	Max Amp [mV]	Sigma [mV]
1 grain 1st batch	257.1	36.1
1 grain 1st batch	307.7	34.9
1 grain 2nd batch	302.5	32.9
1 grain 2nd batch	290.2	36.6
Grains 1st batch	260.7	59.2
Grains 2nd batch	292.7	43.1
0.85 mm plate	298.2	36.9
1.03 mm plate	300.3	34.0
2.14 mm plate	284.2	36.6
3.14 mm plate	266.9	35.1
4.25 mm plate	272.8	34.5
1 cm ³ crystal	181.4	26.7
2x2x4 cm ³ crystal	125.9	23.2

New

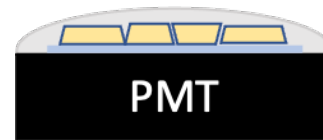

First test bench results

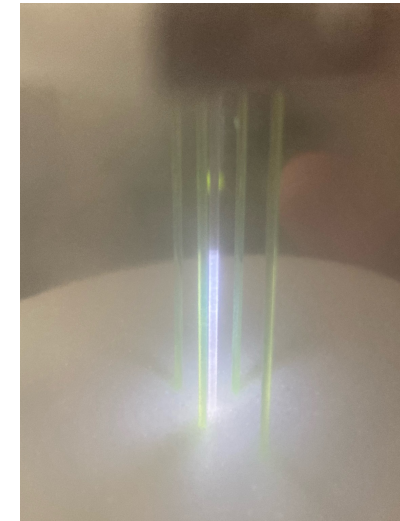
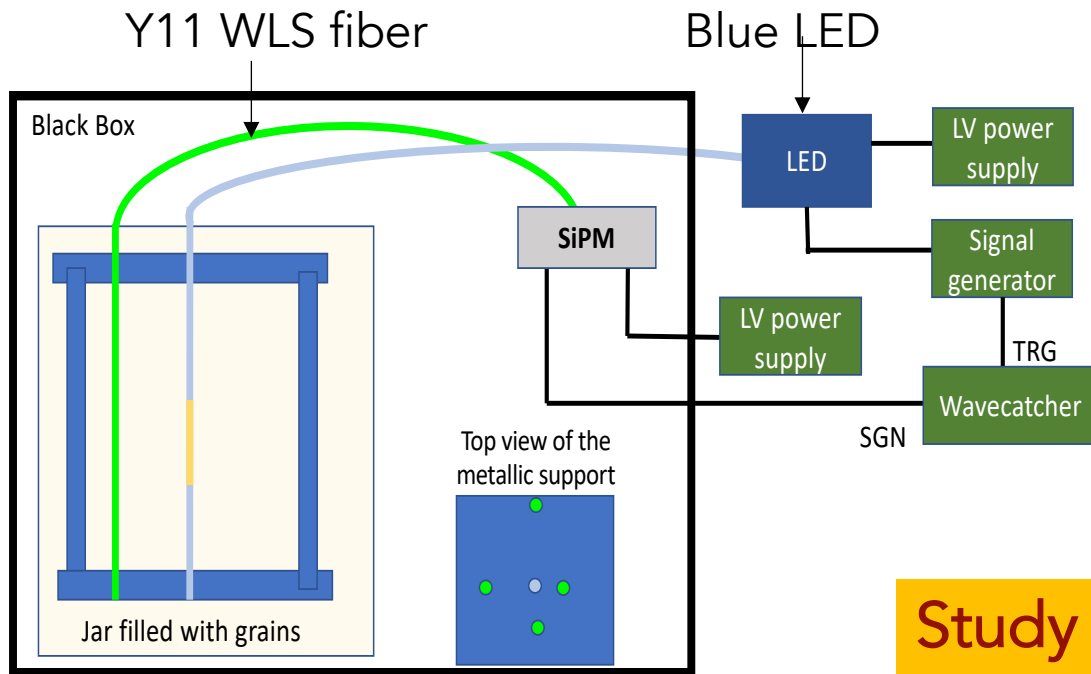

Study of the pulse time delay: average light path in ZnWO_4 + propanol ~ 17 cm

Light absorption too large (wrt to kitchen salt test)

→ new studies with the new ZnWO_4 grains, a green LED and a better matched WLS fiber

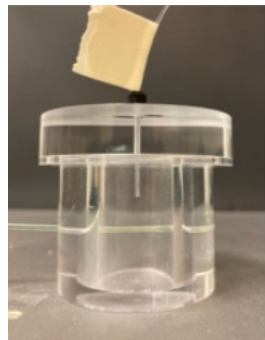

< 50 g of ZnWO_4

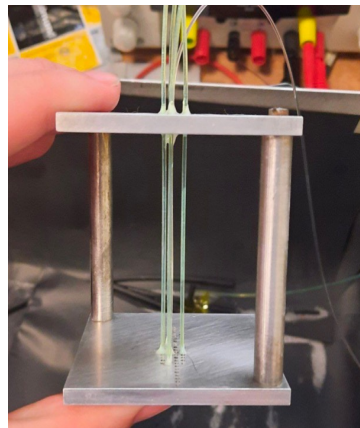

Which fibers work better for ZnWO_4 ?

New

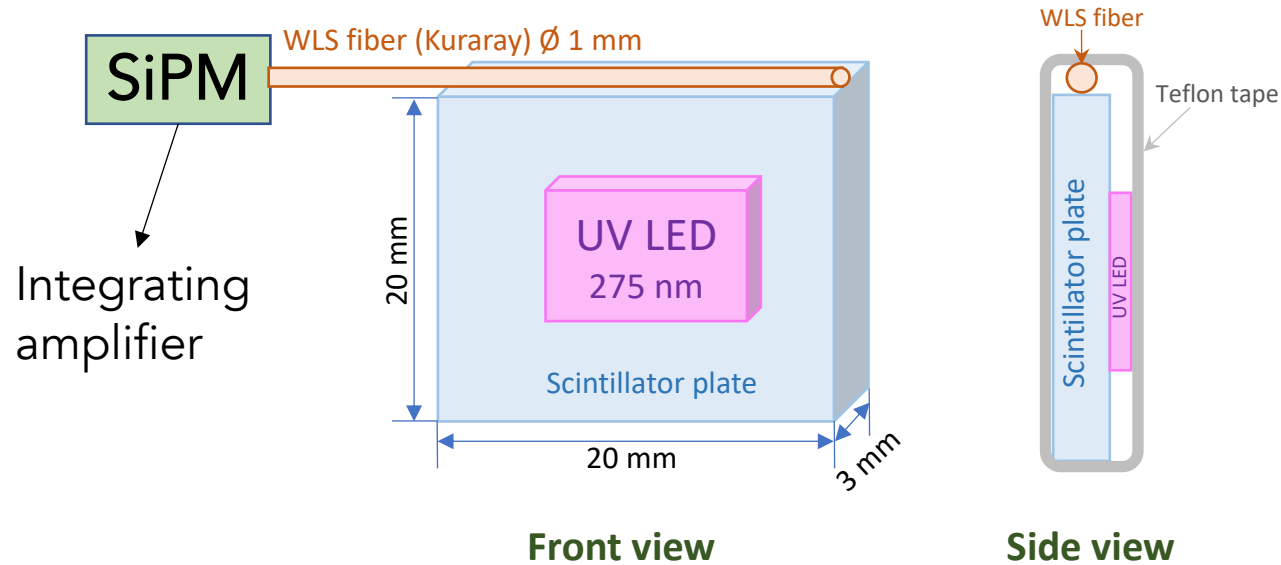

Amount of light created by the UV LED is different from those created by ionizing particles but the wave length is very similar

UV LED :

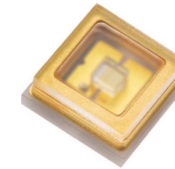

VLMU35CB2.-275-120
 λ : 270 – 280 nm

A set of different fibers provided by Kuraray:

- Y11 (200)
- O2(100)
- O2(300)
- R3(300)

BGO + O2(100)

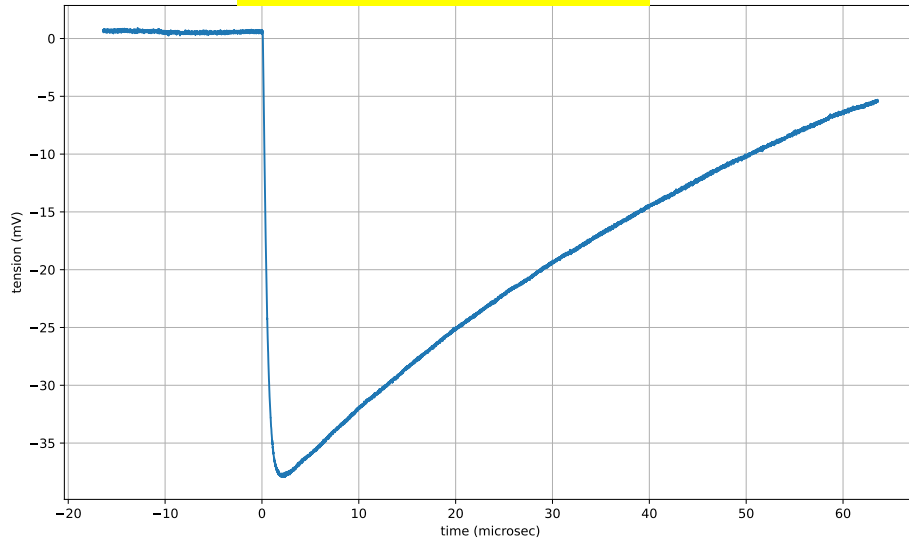

ZnWO₄ + O2(100)

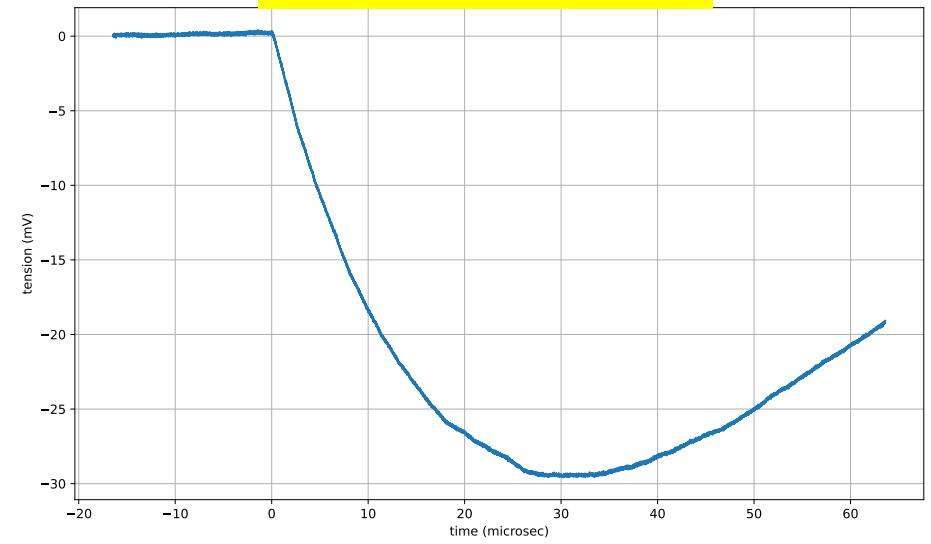

Plastic Scintillator+ Y11(200)

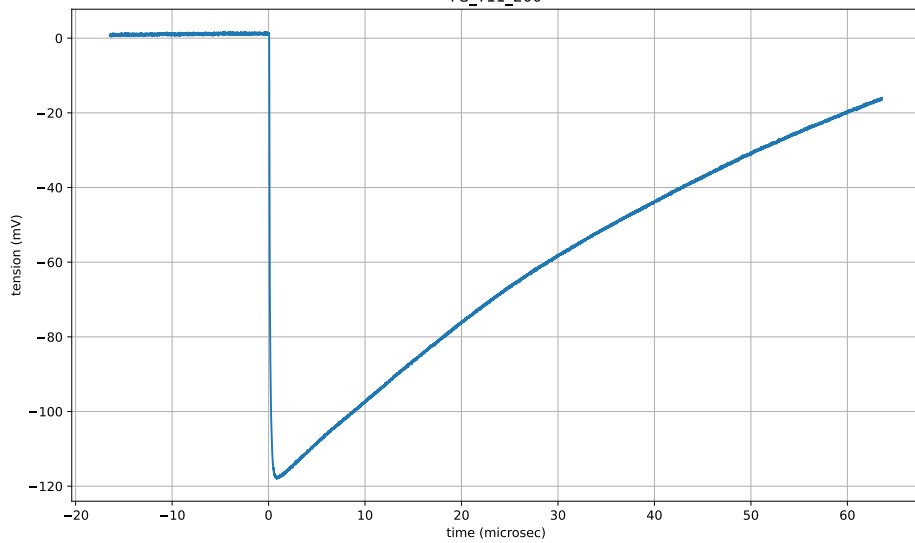

+ amplifier integrator with long time constant, amplitude

➔ charge

➔ Number of photo-electrons

$$\frac{RMS}{Amplitude} = \frac{1}{\sqrt{N_{phe}}}$$

Sci + Fiber	Amplitude (pc)	Corrected RMS (pc)	N_{phe}	Comment
ZnWO ₄ + O2(100)	325	61.33	28.1	Best configuration
ZnWO ₄ + Y11(200)	237	48.65	23.8	
ZnWO ₄ + O2(300)	203	49.9	16.5	
ZnWO ₄ + R3(300)	290	57.0	25.9	
Plastic + Y11(200)	994	72.3	189	SiPM saturation (600 cells)
BGO + Y11(200)	288	46.9	37.7	
BGO + O2(100)	334	55.7	35.9	

RMS corrected for
the dark current
SiPM # of phe (LED
OFF measurements)

$$\frac{RMS}{Amplitude} = \frac{1}{\sqrt{N_{phe}}}$$

O2(100) best fiber for ZnWO₄, well working also for BGO

Higher light yield from plastic scintillator compared to ZnWO₄ : due to UV excitation ? (it is the same for ionizing particles) . Seems to be the case for a scintillator + PMT read-out (back-up).

Try with 2 types of fibers ?

New

ZnWO₄+ Y11(200) or O2(100) WLS fiber (Kuraray)+SiPM (Hamamatsu S13360-3075CS)

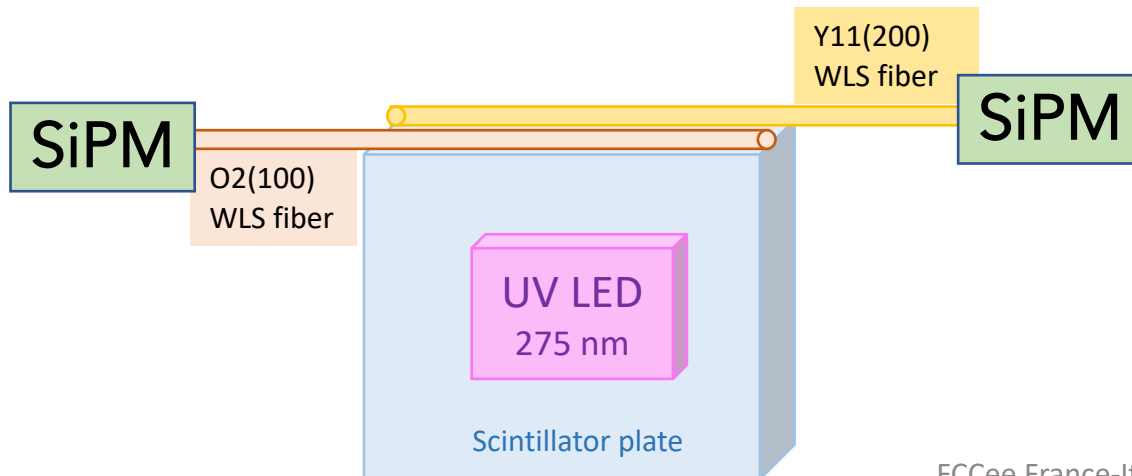
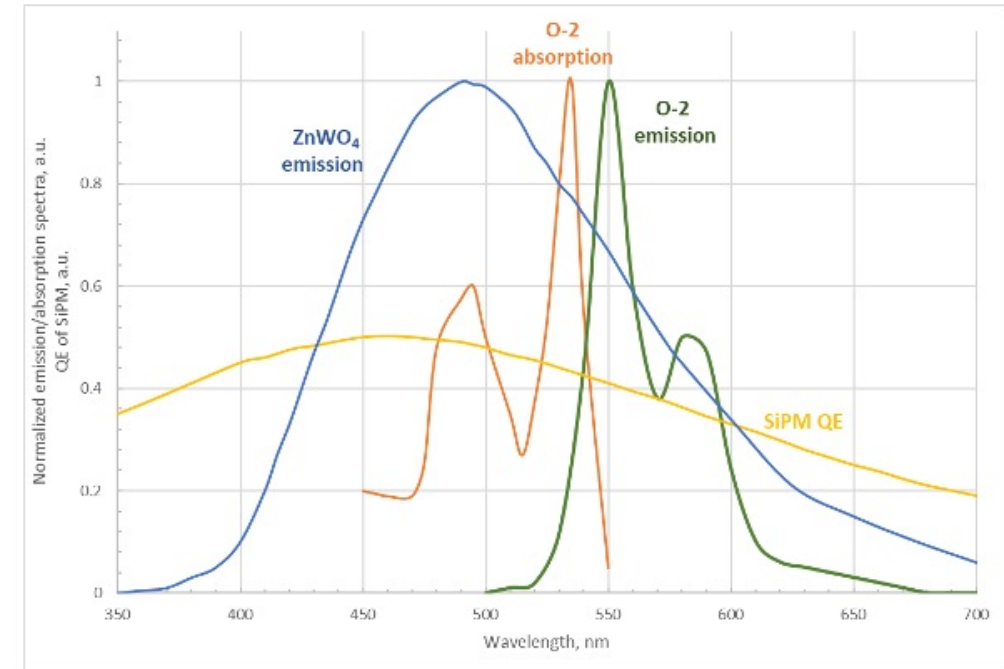
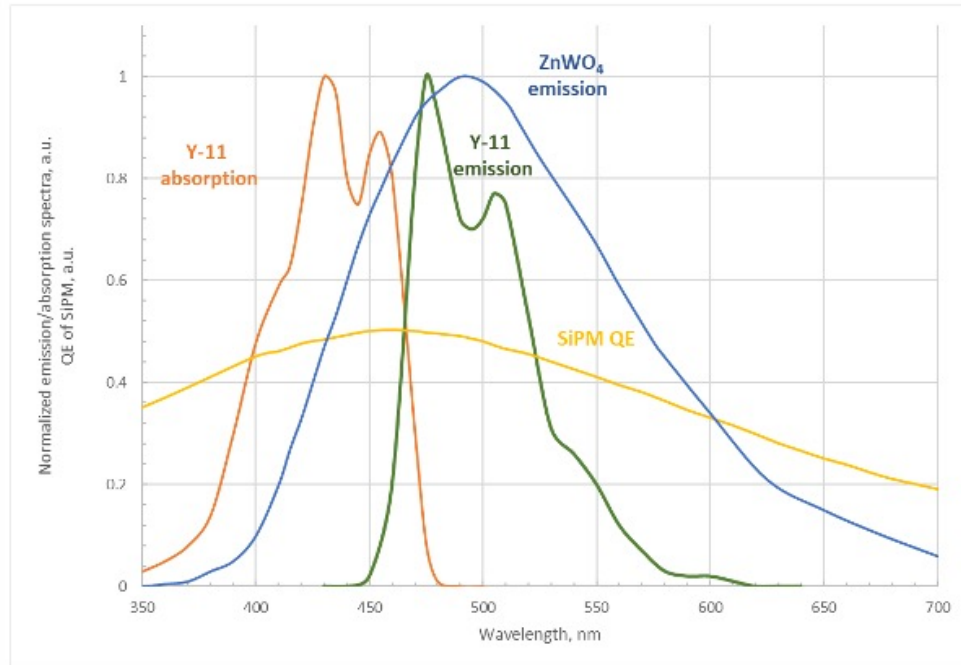

No obvious significant gain with respect to two identical fibers : at most 10%
→ not considered further

Towards a 16 fibers test bench

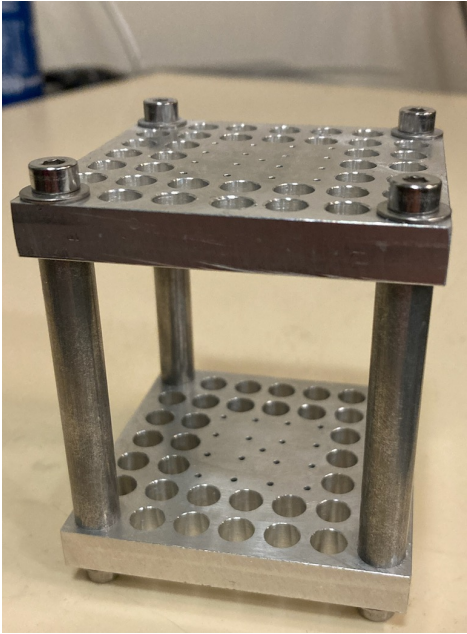

- Active volume = $2.8 \times 2.8 \times 6 \text{ cm}^3$ ($\sim 200 \text{ g}$ of ZnWO_4)
- Fibers spacing: 7 mm
- 16 fibers read-out by SiPM
- Possibility to repeat the study with the well known BGO

- Blue/Green LED injected in the middle (& UV LED with a quartz fiber ?)
- Cosmic rays triggering

What will we learn ?

- Number of photo-electrons par GeV
- Study the uniformity response (μ close to a fiber or half-way)

Cosmic rays test bench design

Proposal:

- ▶ Upper sensor: 2 layers of TimePix3
 - ▶ 0.3° angular resolution
 - ▶ Perform the track reconstruction
 - ▶ 2 cm² (!)
- ▶ Lower sensor: 2 scintillator tiles
 - ▶ Detect stopping muons
 - ▶ Timing

Expected yield \approx 1800 muons/day

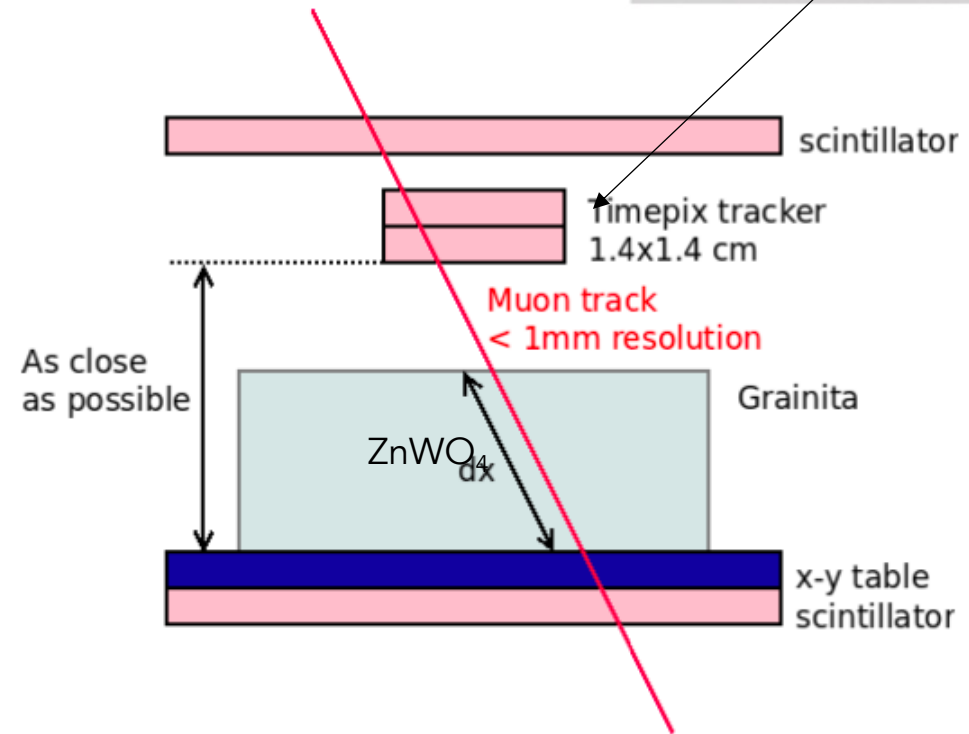
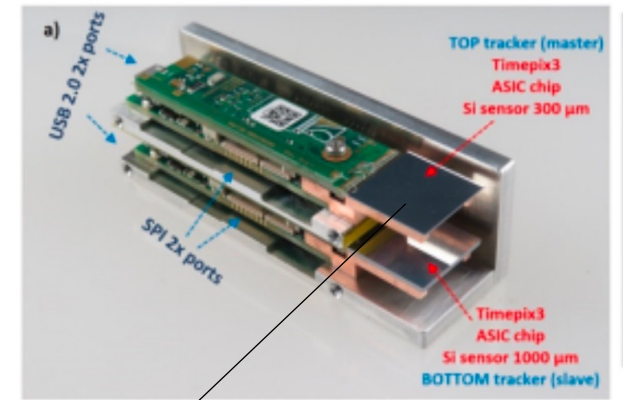

Pulse Shape Discrimination

Two components (one fast, one slow) for the scintillation decay time in inorganic crystal

Higher ionizing particles (low E proton) : higher fraction of fast component

With ZnWO₄: clear difference between γ and α (<https://arxiv.org/pdf/nucl-ex/0409014.pdf>)

Type of irradiation	Decay constants, μs		
	$\tau_1 (A_1)$	$\tau_2 (A_2)$	$\tau_3 (A_3)$
γ ray	0.7 (2%)	7.5 (9%)	25.9 (89%)
α particles	0.7 (4%)	5.6 (16%)	24.8 (80%)

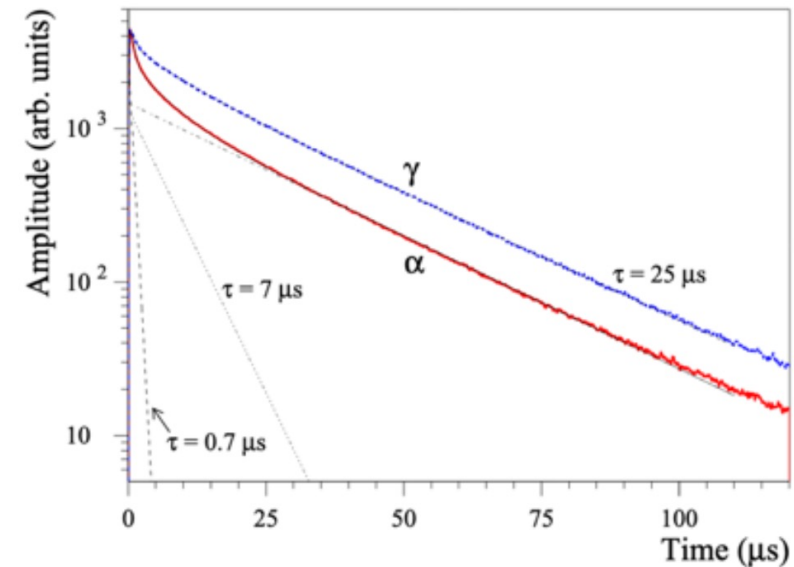
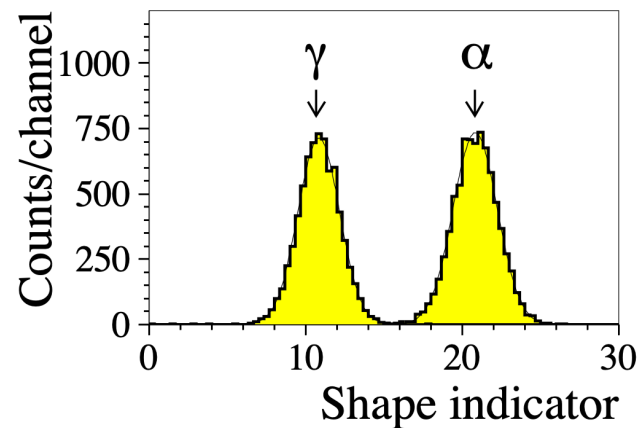

First step : different responses of electrons and pions

Starting a Geant4 simulation

Starting

ZnWO₄ / CH₂I₂ homogenous volume:

10 GeV electron

10 GeV pion

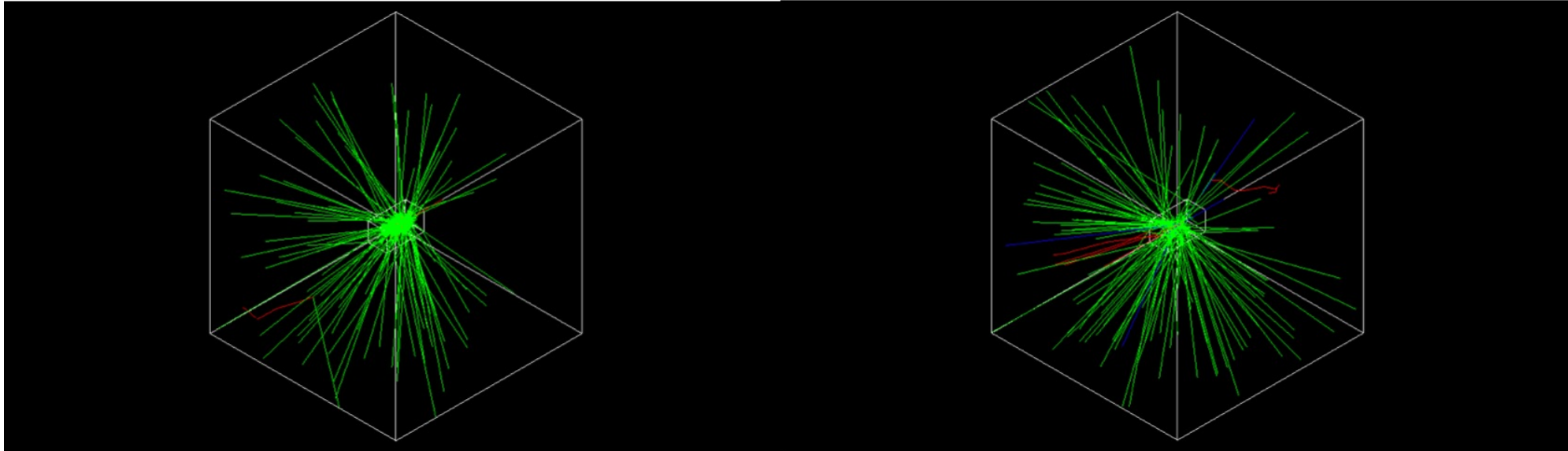

What's next ?

- Building and analyzing the 16-fibers prototype
- Build a calorimeter module (~ 35 kg ZnWO_4) with horizontal fibers
- Could we still improve the grains technology ?
- What about further fiber development ?
- Beam test

Stay tuned !

backup slides

Test of scintillators: reference point

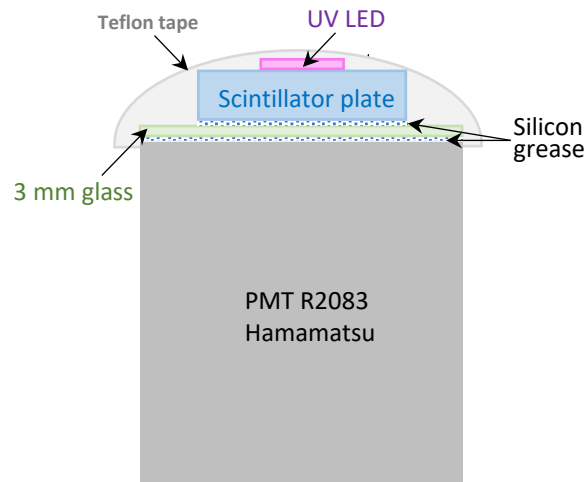

UV LED
 VLMU35CB2.-275-120
 λ : 270 – 280 nm

Scintillator type	Pulse maximum	Average PMT QE
ZnWO ₄ 4mm plate	0.35 V	14%
ZnWO ₄ 2mm plate	0.34 V	14%
BGO 2mm plate	0.25 V	16.5%
Plastic Sci 3mm plate	1.25 V	25%

Issue do the the very long signal (not fully integrated) → lower voltage

Ratio of BGO wrt Plastic : $\frac{0.25 V}{1.25 V} \times 1.13 \times 1.51 = 0.34$

13% of the light is trapped in BGO due to its refractive index wrt to grease

ratio of QE

ZnWO₄+R-3 WLS fiber (Kuraray)+SiPM (Hamamatsu S13360-3075CS)

