

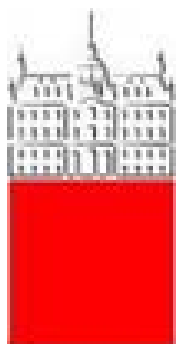

Seminar, CPPM, November 12, 2018

Belle II - status and potential

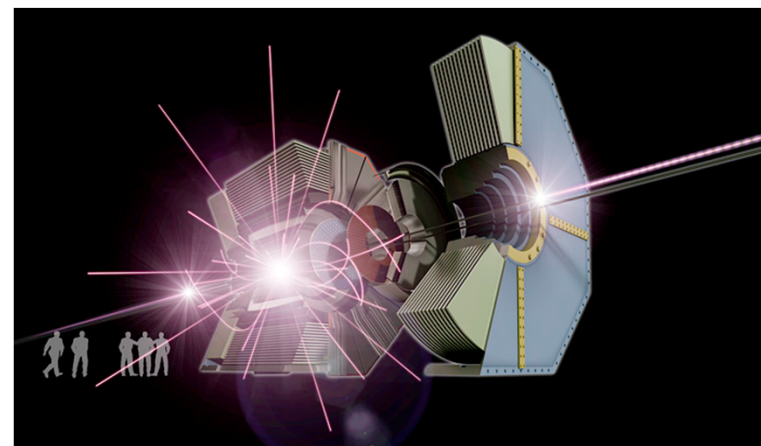

**University
of Ljubljana**

Peter Križan

University of Ljubljana and J. Stefan Institute

**Jožef Stefan
Institute**

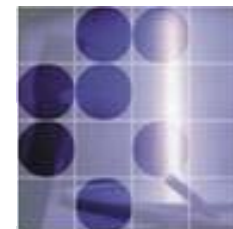



Contents



- Introduction
- SuperKEKB and Belle II: status and outlook
- Belle II physics

B meson production at $\Upsilon(4S)$

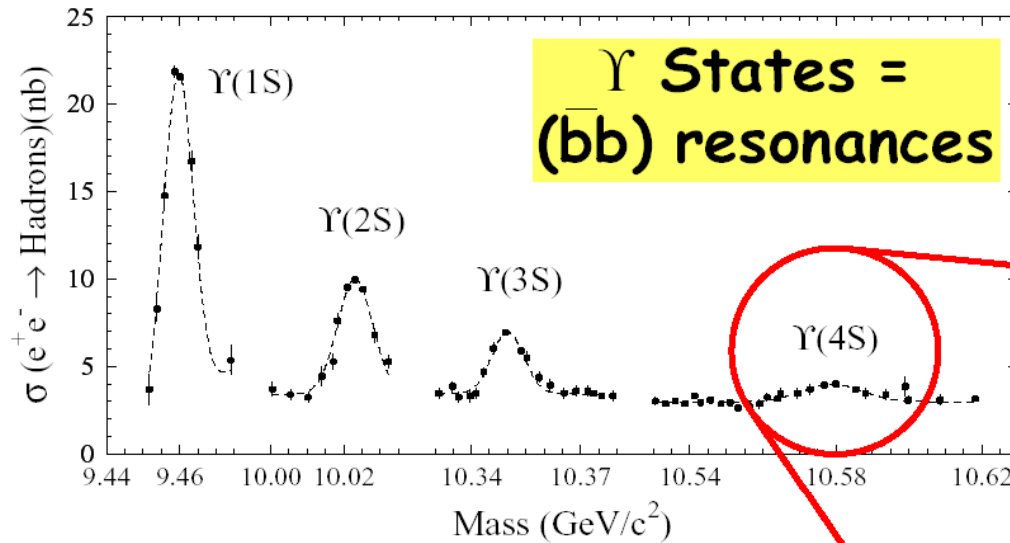

Cross Sections at $\Upsilon(4S)$:

$b\bar{b} \sim 1.1 \text{ nb}$

$c\bar{c} \sim 1.3 \text{ nb}$

$d\bar{d}, s\bar{s} \sim 0.3 \text{ nb}$

$u\bar{u} \sim 1.4 \text{ nb}$

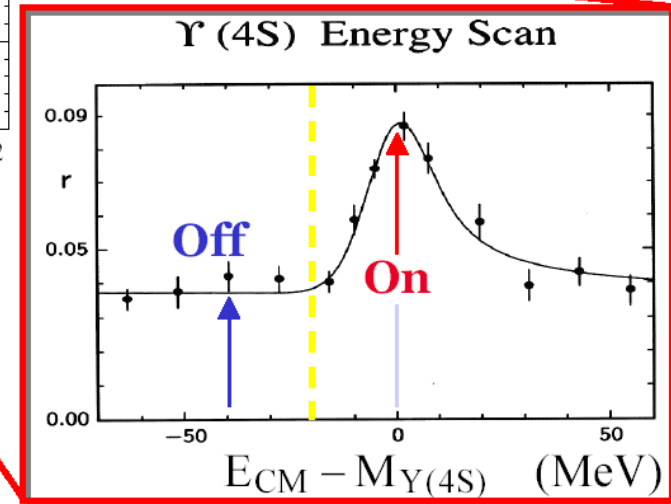

$e^+e^- \rightarrow \Upsilon(4S) \rightarrow B\bar{B}$
 $L=1$ state



Flavour physics at the luminosity frontier with asymmetric B factories

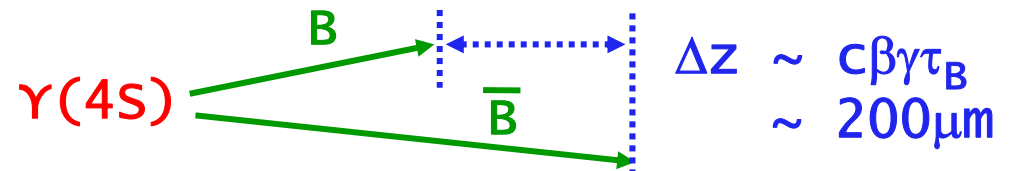
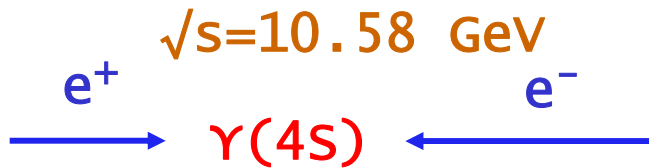
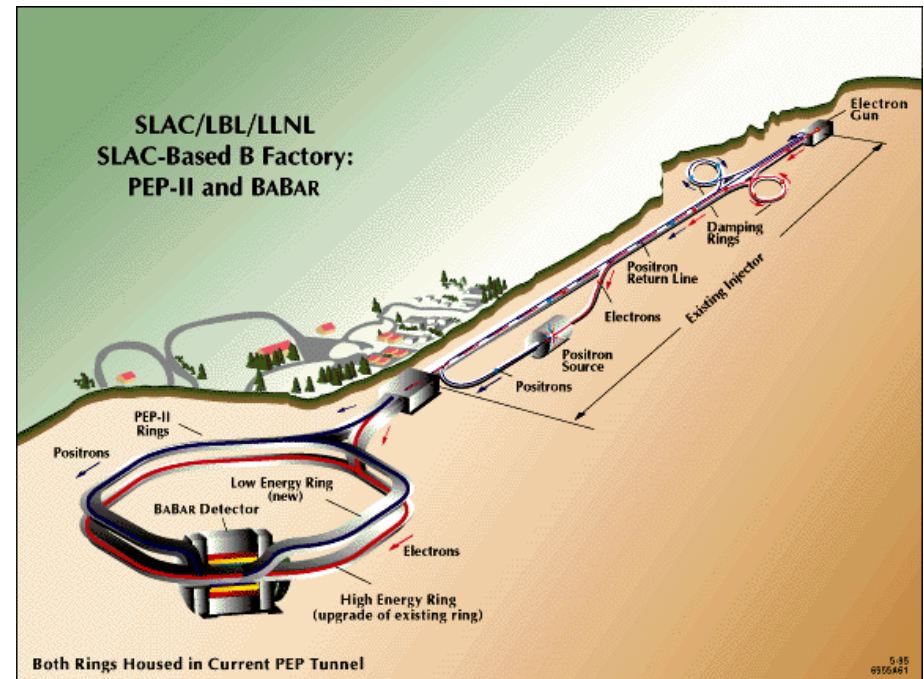
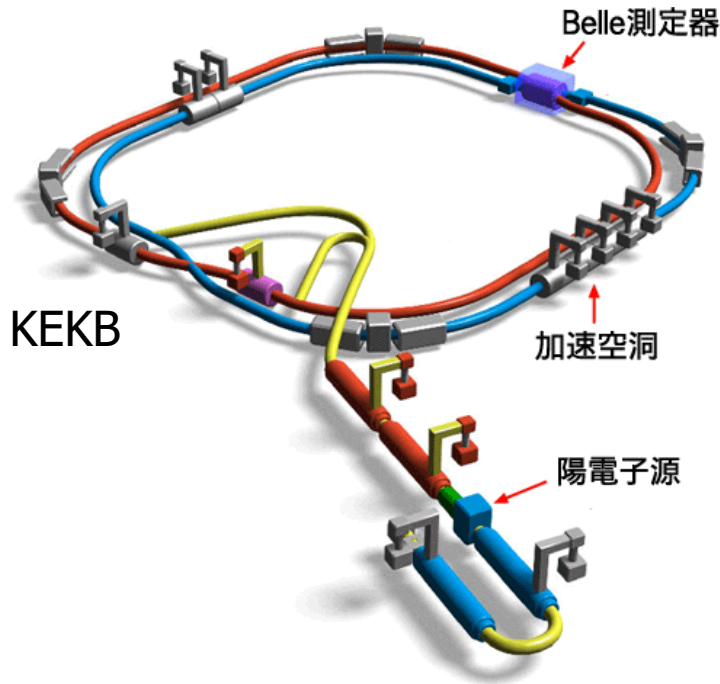

BaBar	$p(e^-) = 9 \text{ GeV}$	$p(e^+) = 3.1 \text{ GeV}$
Belle	$p(e^-) = 8 \text{ GeV}$	$p(e^+) = 3.5 \text{ GeV}$

$\beta\gamma = 0.56$
$\beta\gamma = 0.42$

To a large degree shaped flavour physics in the previous decade

Belle spectrometer at KEK-B

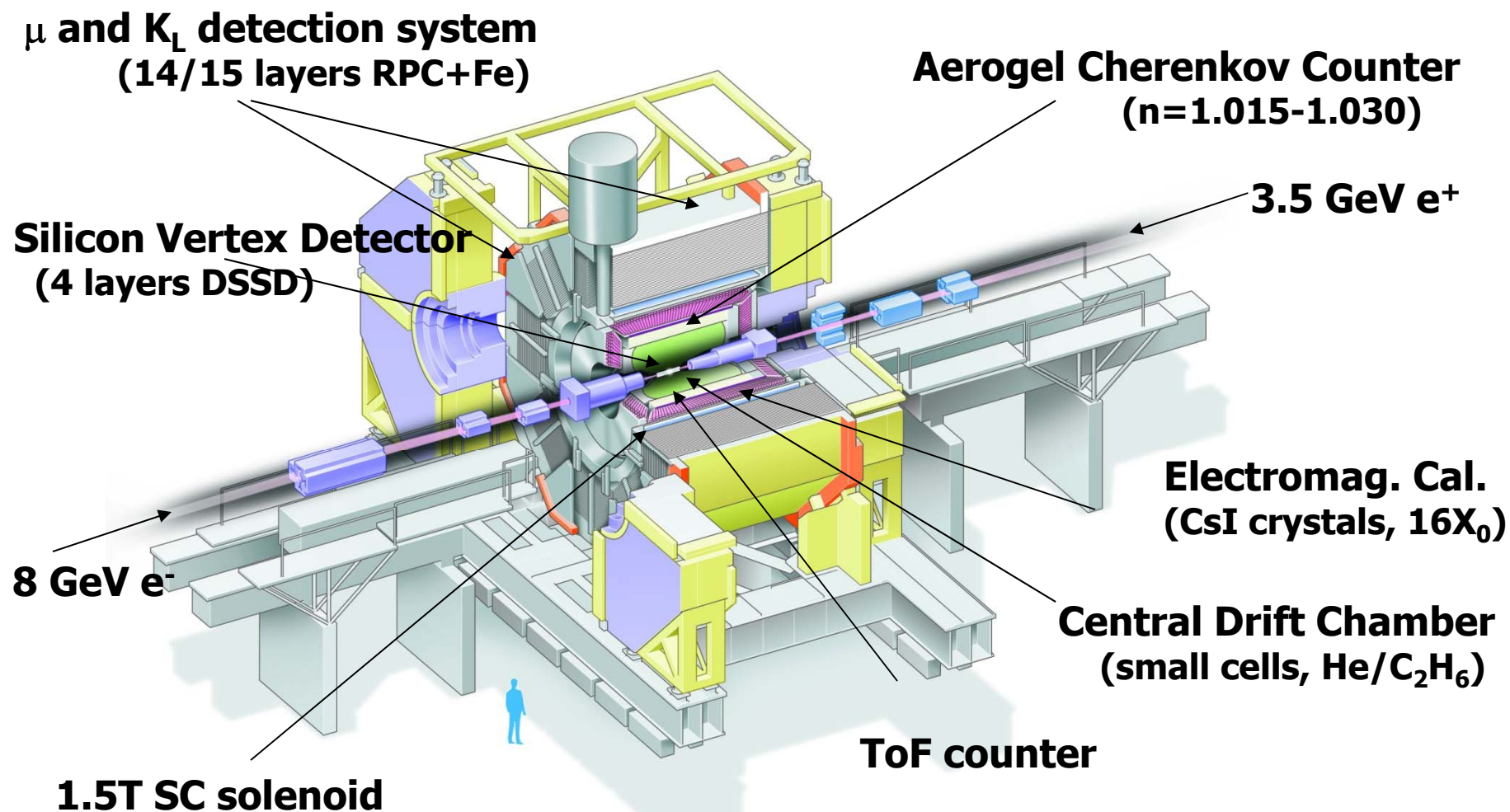

CP violation in the B meson system: measurement of the CKM phase

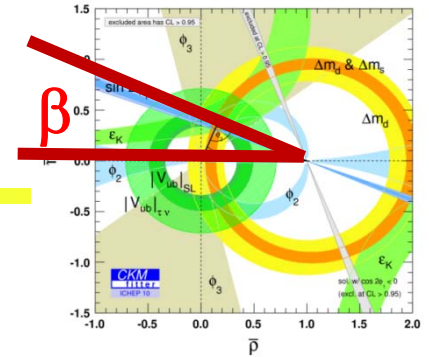

ϕ_1 from CP violation measurements in $B^0 \rightarrow J/\psi K^0$

$$a_{f_{CP}} = -\text{Im}(\lambda_{f_{CP}}) \sin(\Delta mt) = \sin 2\phi_1 \sin(\Delta mt)$$

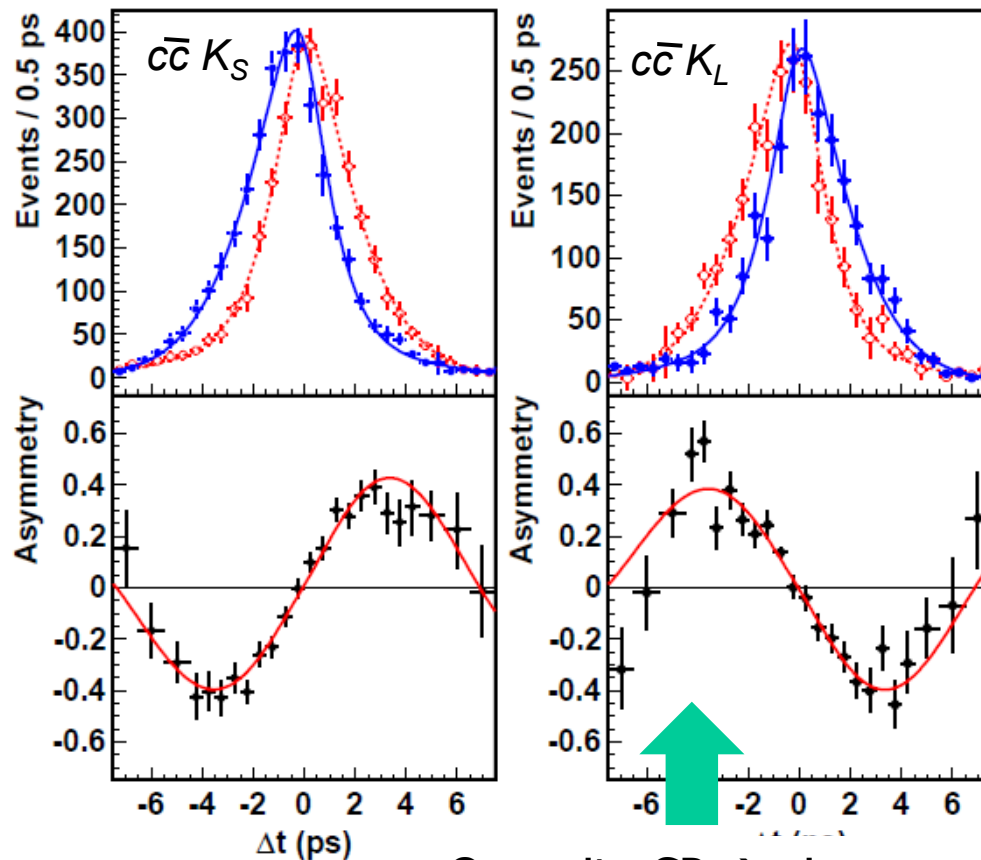

Opposite CP \rightarrow sine wave with a flipped sign

$\sin 2\phi_1 (= \sin 2\beta)$

Belle: $0.668 \pm 0.023 \pm 0.012$

BaBar: $0.687 \pm 0.028 \pm 0.012$

Belle, PRL 108, 171802 (2012)

BaBar, PRD 79, 072009 (2009)

with a single experiment
precision of $\sim 4\%$!

$$\phi_1 = \beta = (21.4 \pm 0.8)^\circ$$

CP violation in the B system

B factories: CP violation in the B system: from the **discovery** (2001) to a **precision measurement** (2011) → remarkable agreement with the **Kobayashi-Maskawa prediction!**

EPS 2001

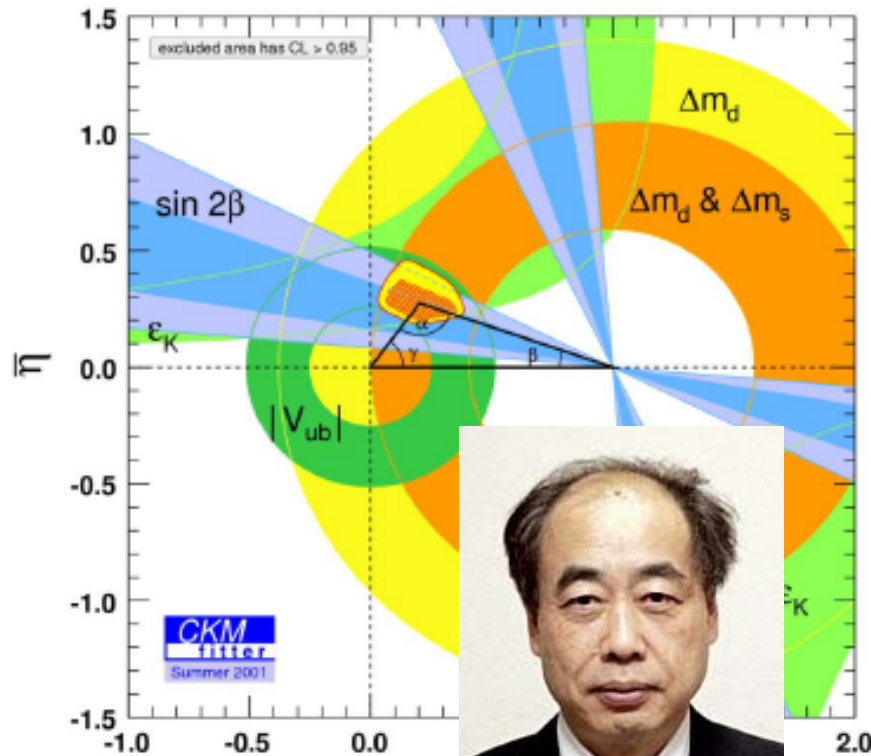

EPS 2011

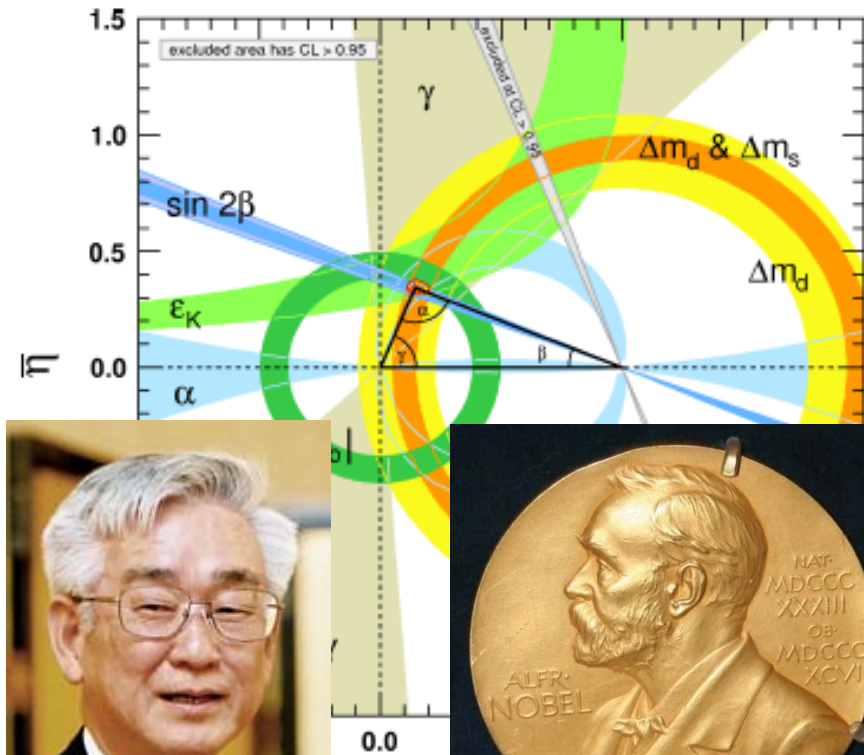

Peter Hinz, Ljubljana

What next?

Next generation: Super B factories → Looking for NP

→ Need much more data (almost two orders!)

However: a hard competition from LHCb and BESIII

Still, an e^+e^- machine running at (or near) $\Upsilon(4s)$ will have considerable advantages in several classes of measurements, and will be complementary in many more

- Physics at Super B Factory, arXiv:1002.5012 (Belle II)
- SuperB Progress Reports: Physics, arXiv:1008.1541 (SuperB)
- Physics at B Factories, Eur. Phys. J. C74 (2014) 3026
- Belle II Theory Interface Platform (B2TiP), arXiv:1808.10567, to be published in PTEP **New!**

Advantages of B factories in the LHC era

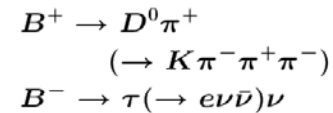

Unique capabilities of B factories:

- Exactly two B mesons produced (at $\Upsilon(4S)$)
- High flavour tagging efficiency
- Detection of gammas, π^0 s, K_L s
- Very clean detector environment (can observe decays with several neutrinos in the final state!)

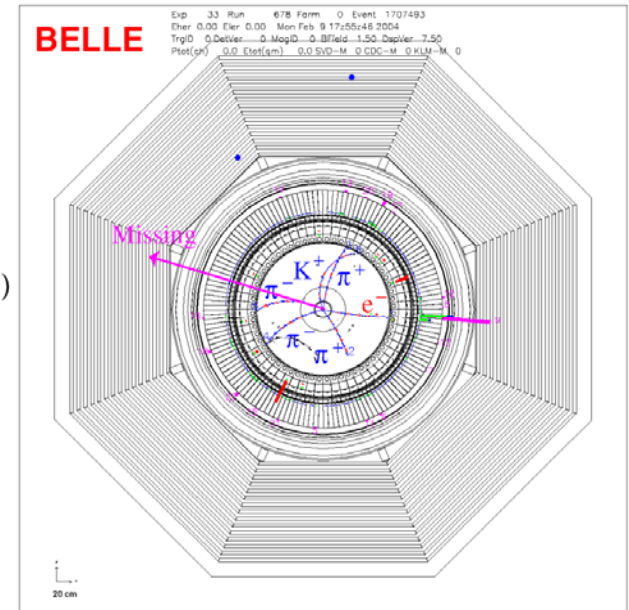

However, need a two-orders-of-magnitude larger data sample!

Need O(100x) more data → Next generation B-factories

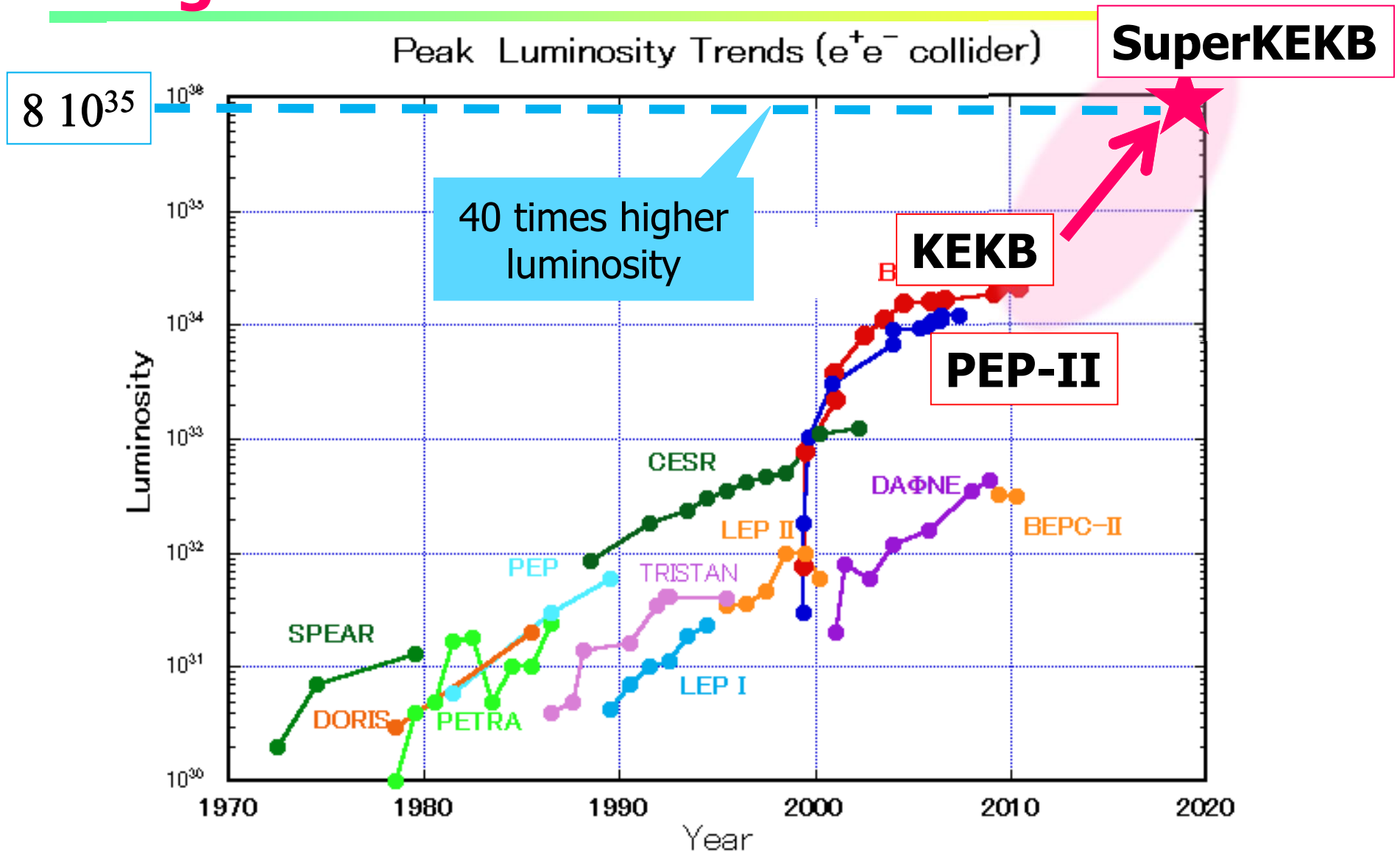

N.B. KEKB peak L: $2.11 \cdot 10^{34} \text{ cm}^{-2} \text{ s}^{-1}$, LHC peak L: $2.06 \cdot 10^{34} \text{ cm}^{-2} \text{ s}^{-1}$

Peter Križan, Ljubljana

How to do it?

→upgraded the existing KEKB and Belle facility

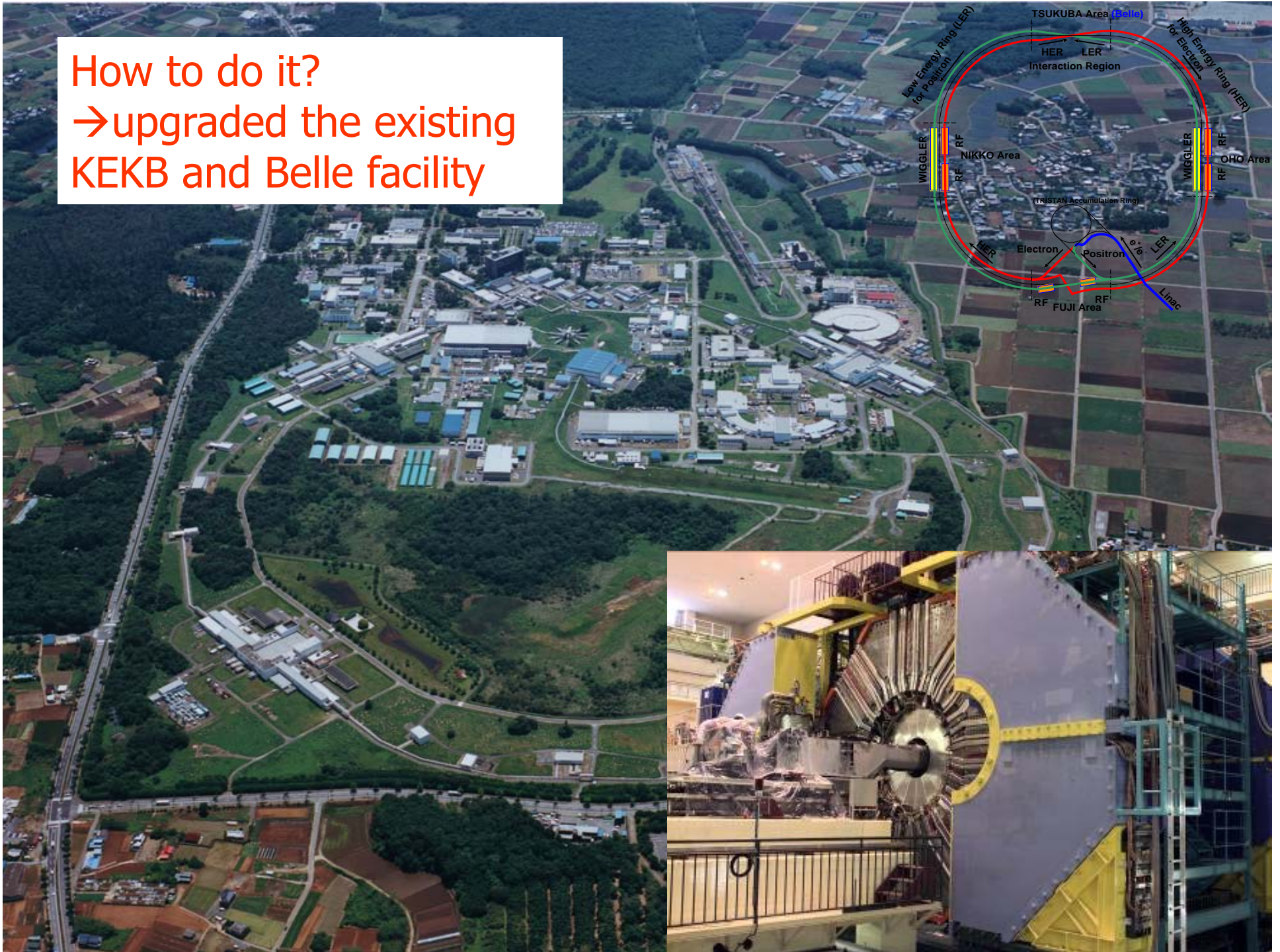

How to increase the luminosity?

$$L = \frac{\gamma_{e\pm}}{2er_e} \left(1 + \frac{\sigma_y^*}{\sigma_x^*} \right) \left(\frac{I_{e\pm} \xi_{\zeta y}^{e\pm}}{\beta_y^*} \right) \left(\frac{R_L}{R_{\xi_y}} \right)$$

Lorentz factor $\gamma_{e\pm}$
 Beam current $I_{e\pm}$
 Beam-beam parameter $\xi_{\zeta y}^{e\pm}$
 Classical electron radius r_e
 Beam size ratio@IP $\frac{\sigma_y^*}{\sigma_x^*}$ (1 - 2 % (flat beam))
 Vertical beta function@IP β_y^*
 Lumi. reduction factor (crossing angle) & Tune shift reduction factor (hour glass effect) $\frac{R_L}{R_{\xi_y}}$ (0.8 - 1 (short bunch))

- (1) Smaller β_y^***
(2) Increase beam currents
 (3) Increase $\xi_{\zeta y}$
- “Nano-Beam” scheme**

Collision with very small spot-size beams

Invented by Pantaleo Raimondi for SuperB

How big is a nano-beam ?



How to go from an excellent accelerator with world record performance – KEKB – to a 40x times better, more intense facility?

In KEKB, colliding electron and positron beams were already **much thinner than a human hair...**

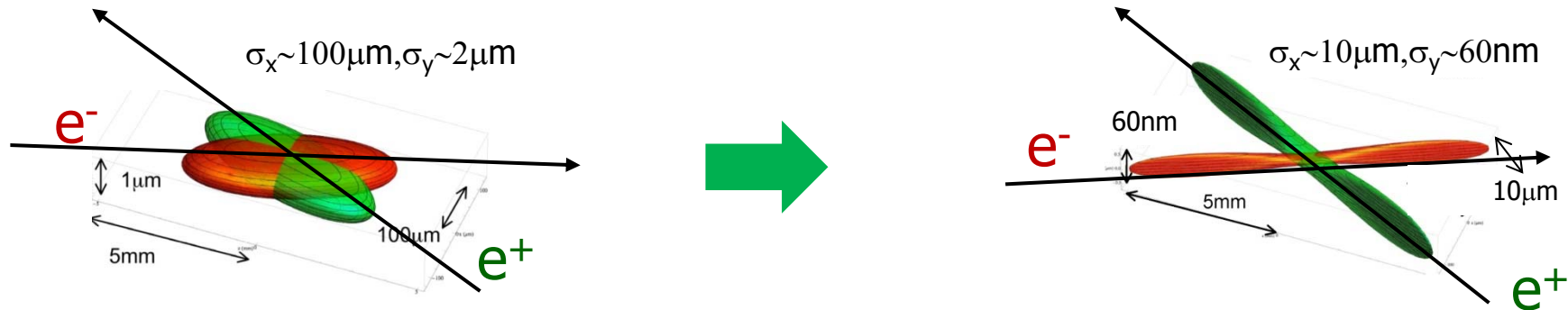

... For a 40x increase in intensity you have to make the beam as thin as a **few x100 atomic layers!**

KEKB → SuperKEKB



Replace short dipoles with longer ones (LER)

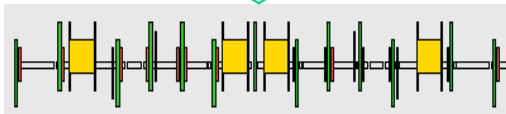
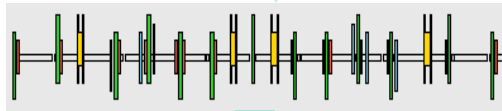

Redesign the lattices of HER & LER to squeeze the emittance

TiN-coated beam pipe with antechambers

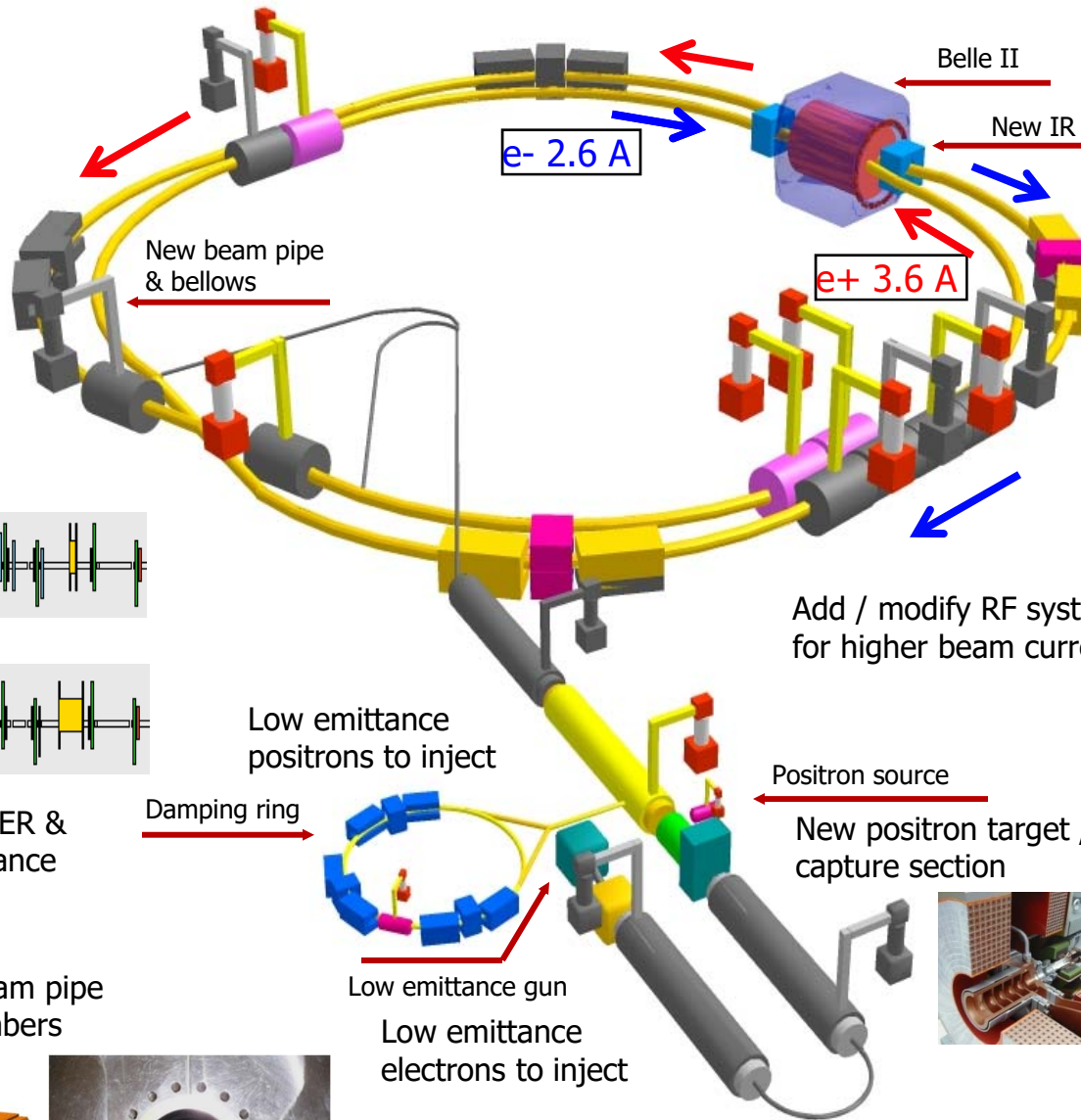
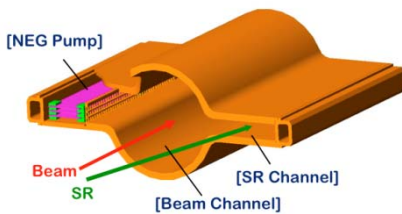

Colliding bunches

New superconducting / permanent final focusing quads near the IP



Add / modify RF systems for higher beam current



Low emittance gun
Low emittance electrons to inject



To get x40 higher luminosity

Installation of 100 new long LER bending magnets

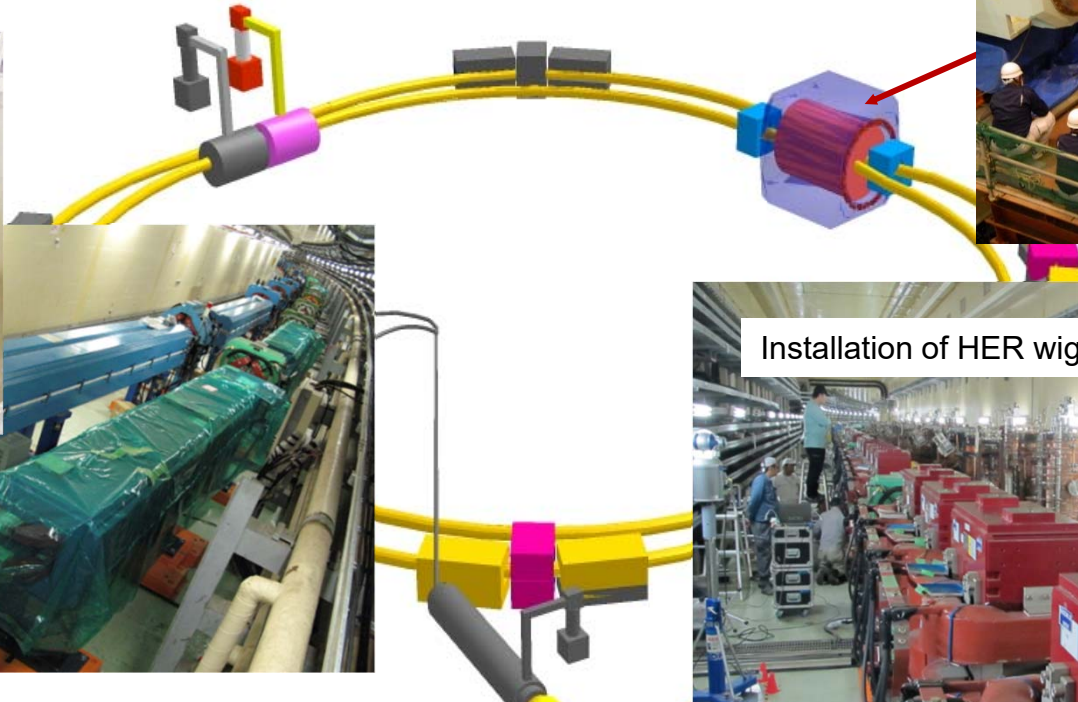

New superconducting final quadrupoles

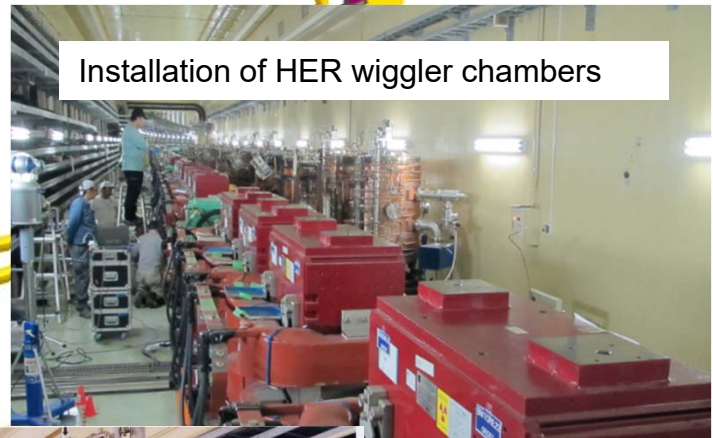

Installation of HER wiggler chambers



Damping ring tunnel

Low emittance positrons

Damping ring

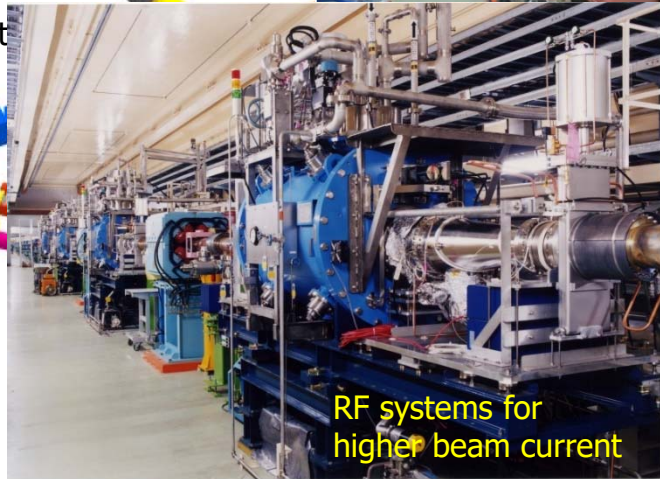
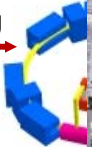

RF systems for higher beam current



SuperKEKB phases and luminosity projection

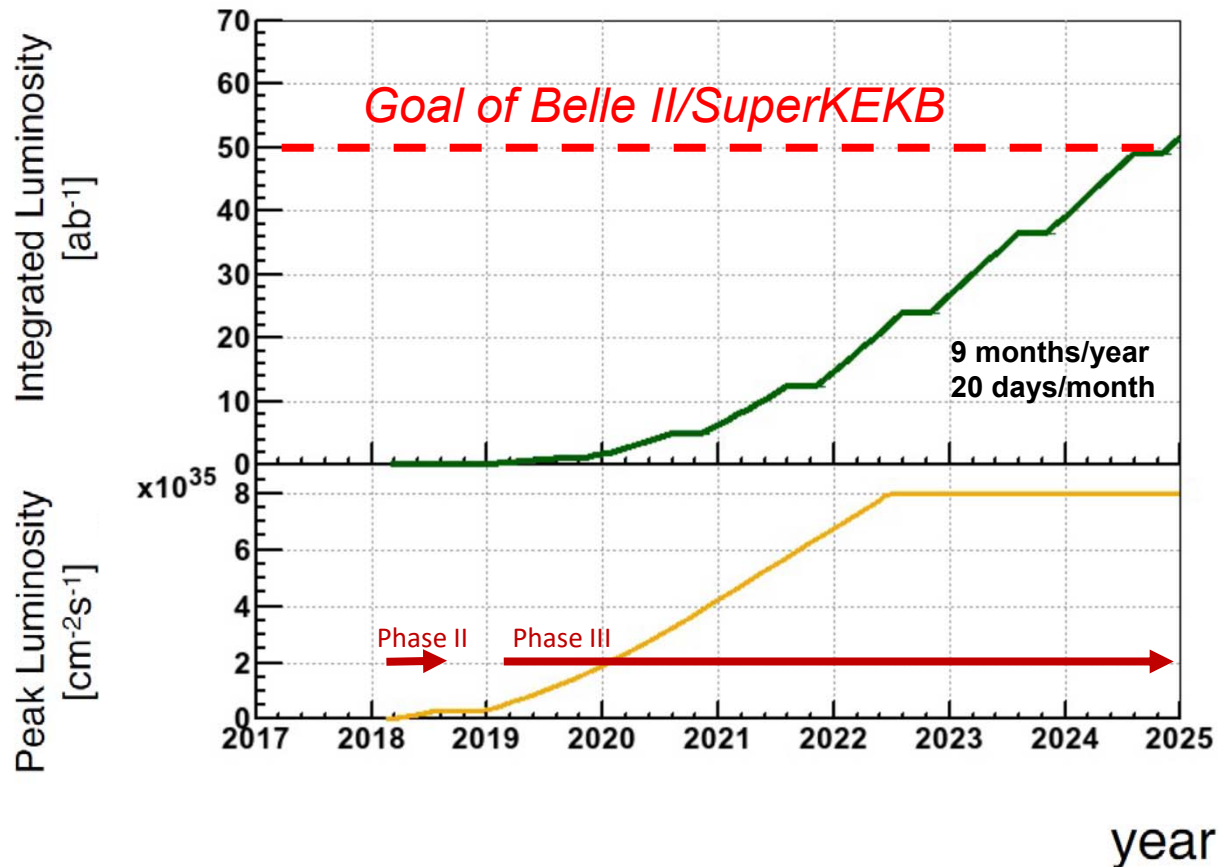

Phase I (2016)

- NO final focus; NO damping ring
- Circulated both beams but no collisions;
- Tune accelerator optics, etc.; vacuum scrubbing
- Beam Background studies with dedicated BEAST II/1 detector

Phase II (2018)

- First collisions
- Beam Commissioning
- Background measurements with BEAST II/2
- Physics run with Belle II without Vertex Detector

Phase III (2019→)

- Physics run



Requirements for the Belle II detector

Critical issues at $L = 8 \times 10^{35}/\text{cm}^2/\text{sec}$

- ▶ **Higher background ($\times 10\text{-}20$)**
 - radiation damage and occupancy
 - fake hits and pile-up noise in the EM
- ▶ **Higher event rate ($\times 10$)**
 - higher rate trigger, DAQ and computing
- ▶ **Require special features**
 - low $p \mu$ identification $\leftarrow s\mu\mu$ recon. eff.
 - hermeticity $\leftarrow \nu$ "reconstruction"

Solutions:

- ▶ Replace inner layers of the vertex detector with a pixel detector.
- ▶ Replace inner part of the central tracker with a silicon strip detector.
- ▶ Better particle identification device
- ▶ Replace part of endcap calorimeter crystals
- ▶ Faster readout electronics and computing system.

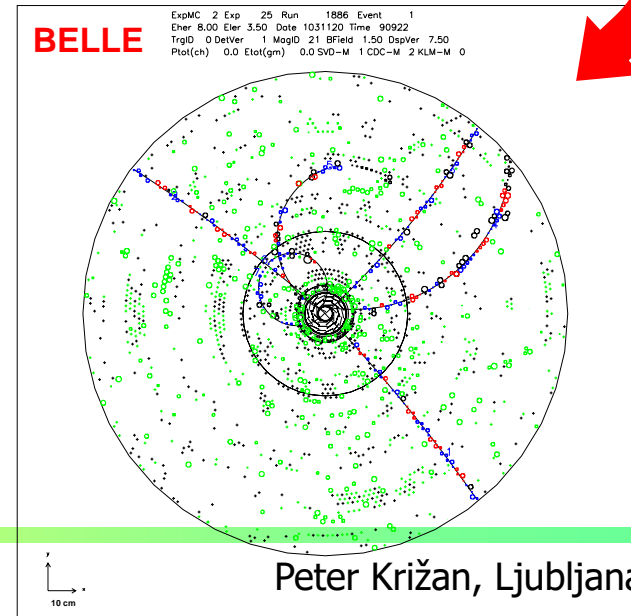
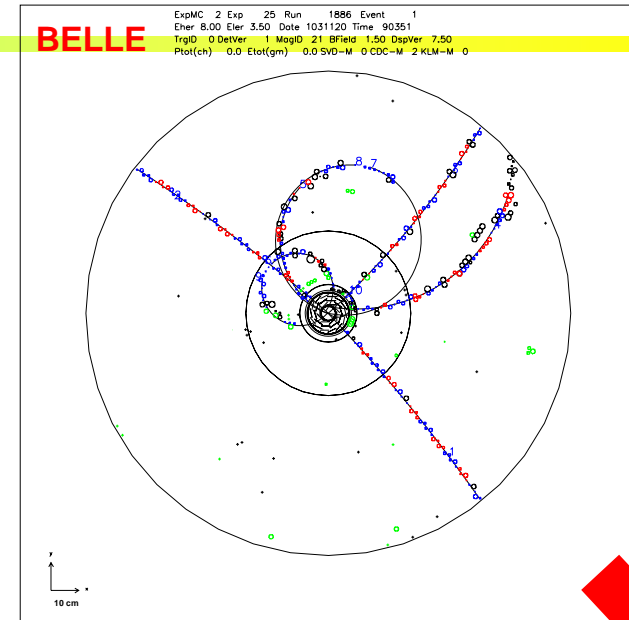

Belle II Detector

KL and muon detector:
Resistive Plate Counter (barrel outer layers)
Scintillator + WLSF + MPPC (end-caps ,
inner 2 barrel layers)

EM Calorimeter:
CsI(Tl), waveform sampling
Pure CsI (part of end-caps)

electrons (7GeV)

Particle Identification
Time-of-Propagation counter (barrel)
Prox. focusing Aerogel RICH (fwd)

Beryllium beam pipe
2cm diameter

Vertex Detector
2 layers DEPFET + 4 layers DSSD

positrons (4GeV)

Central Drift Chamber
He(50%):C₂H₆(50%), small cells, long
lever arm, fast electronics



Belle II Detector (in comparison with Belle)

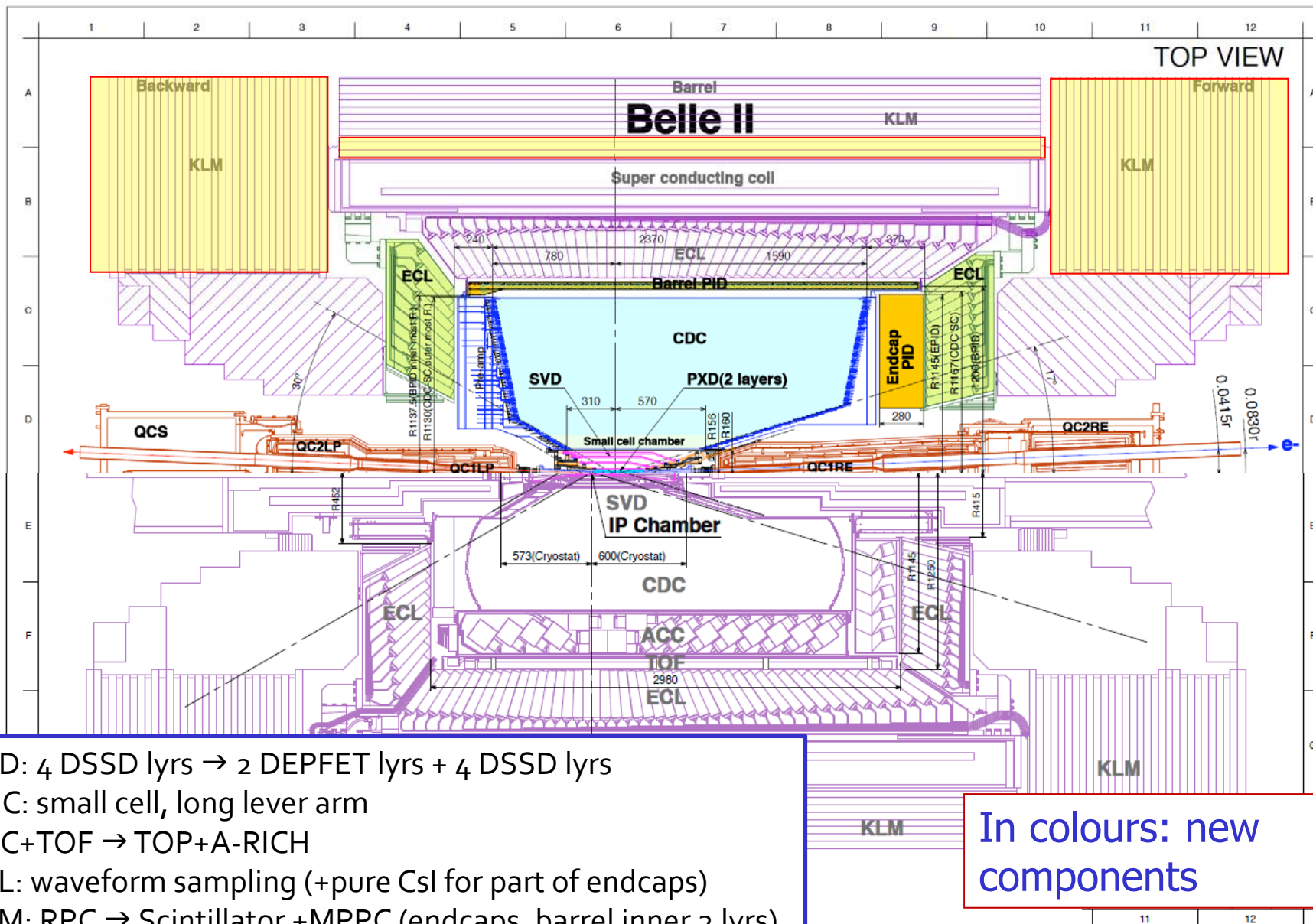

SVD: 4 DSSD lyrs → 2 DEPFET lyrs + 4 DSSD lyrs
 CDC: small cell, long lever arm
 ACC+TOF → TOP+A-RICH
 ECL: waveform sampling (+pure CsI for part of endcaps)
 KLM: RPC → Scintillator +MPPC (endcaps, barrel inner 2 lyrs)

In colours: new components

Belle II Detector – vertex region

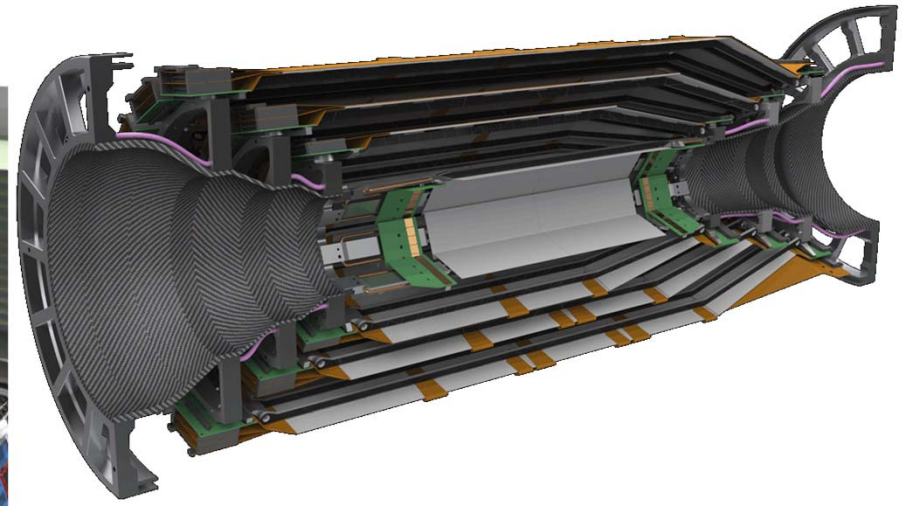
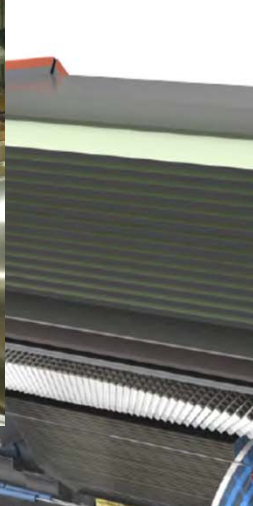

Beryllium beam pipe
2cm diameter

Vertex Detector
2 layers pixels + 4 layers strips

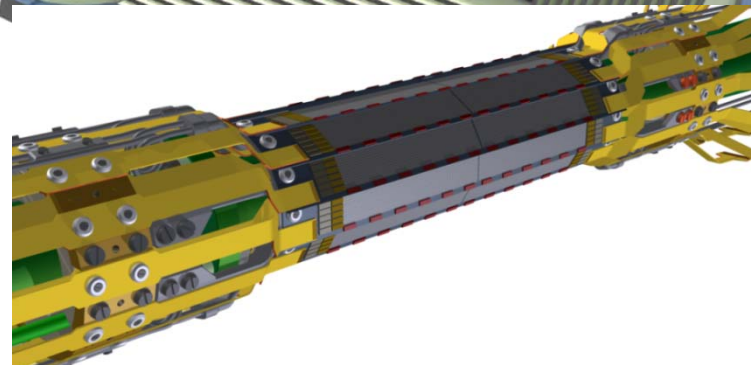
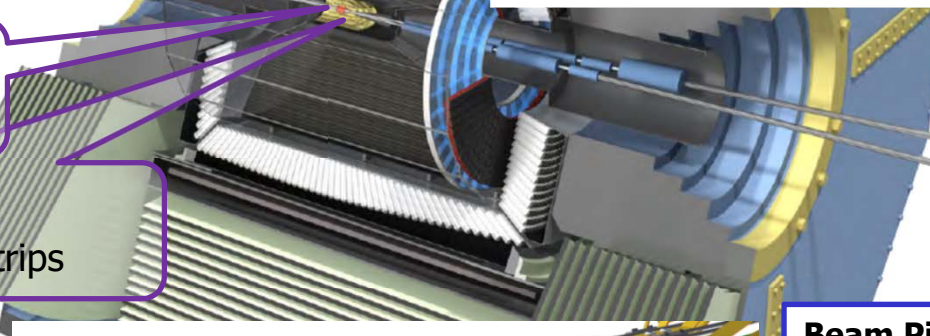

Beam Pipe	r = 10mm
DEPFET pixels	
Layer 1	r = 14mm
Layer 2	r = 22mm
DSSD silicon strips	
Layer 3	r = 39mm
Layer 4	r = 80mm
Layer 5	r = 104mm
Layer 6	r = 135mm

Pixel detector: 2 layers of DEPFET sensors

Mechanical mockup of the pixel detector

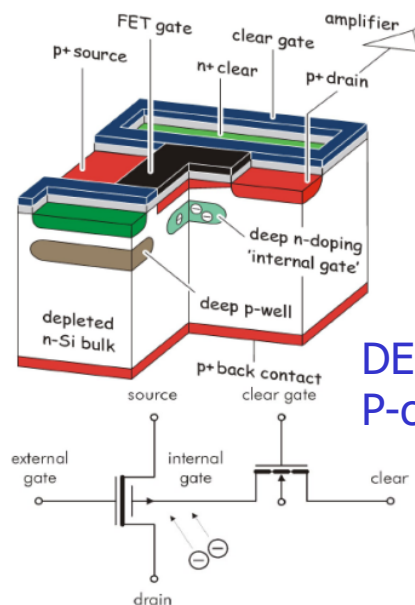

DEPFET sensor (Depleted P-channel FET)

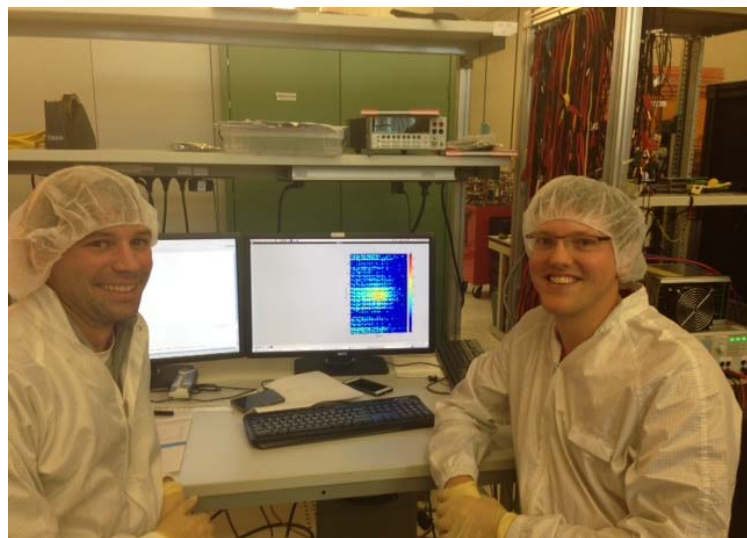

First laser light observed with the full size sensor

Completion of the Layer1 ladders for PXD

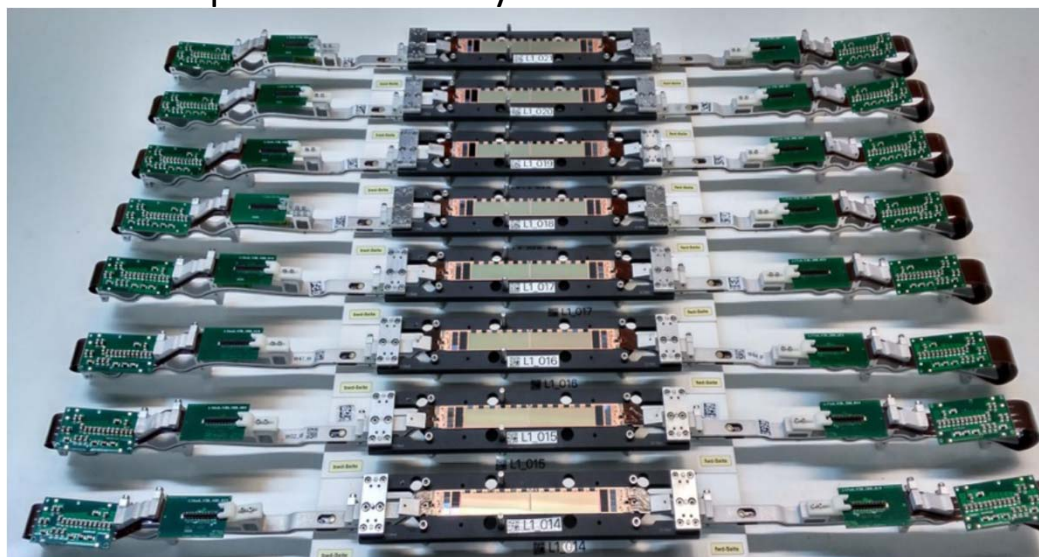

SVD (Silicon Vertex Detector): four layers of double-sided silicon microstrip detectors.

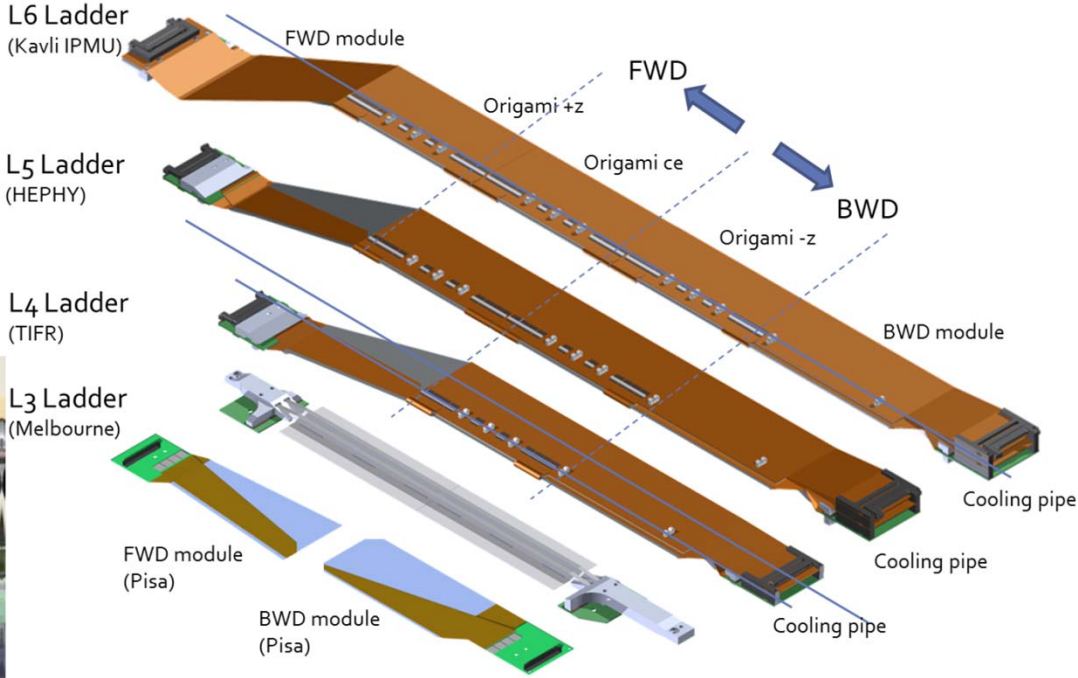
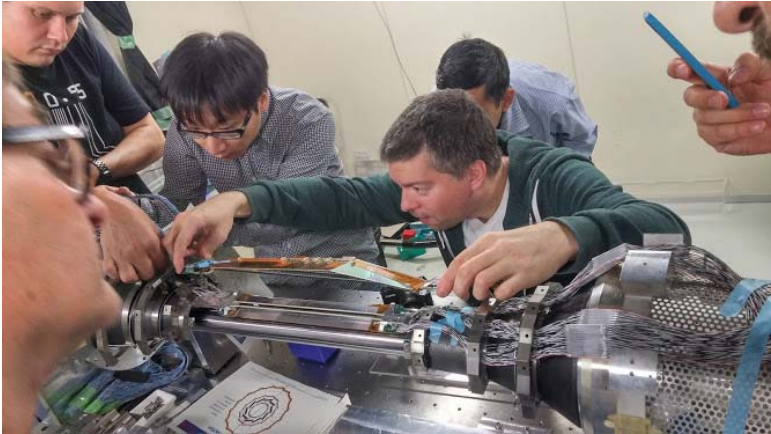
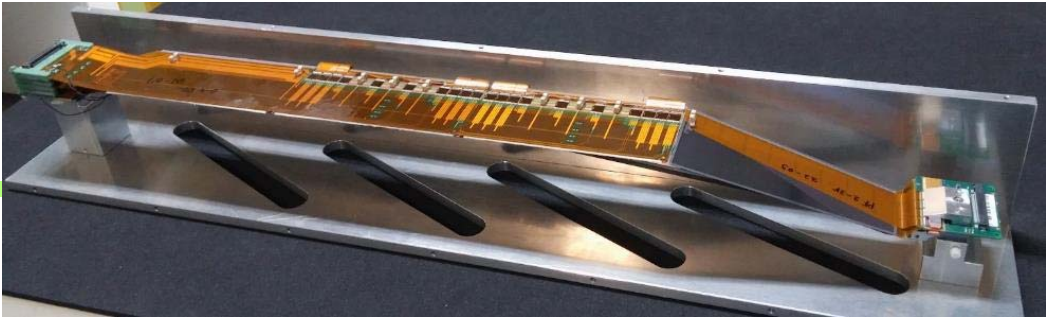

Completion of the first half of SVD on Jan 18, 2018



Expected performance

Significant improvement
in vertex resolution vs
Belle!

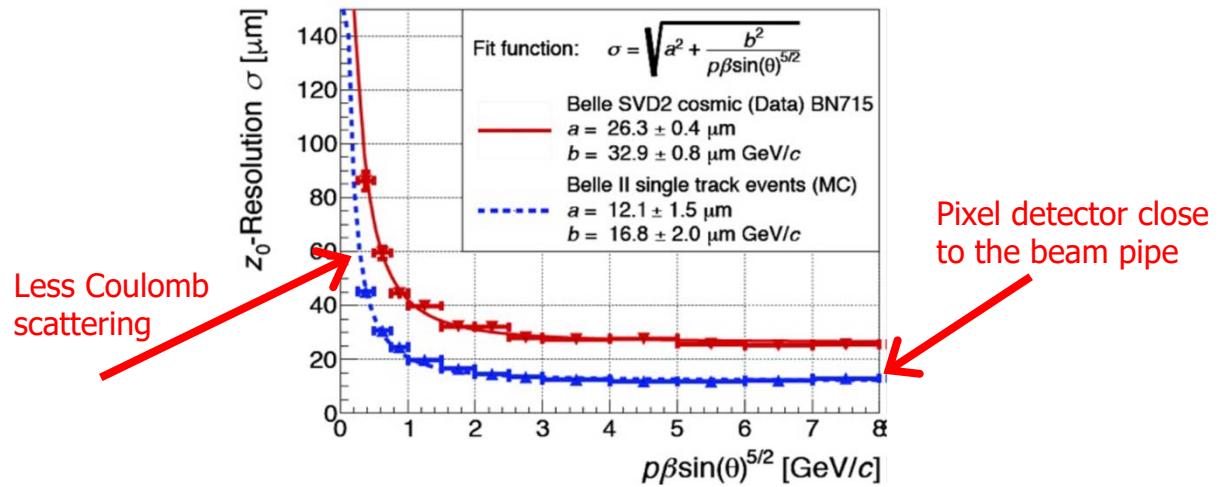

Significant improvement in $\delta S(K_S \pi^0 \gamma)$

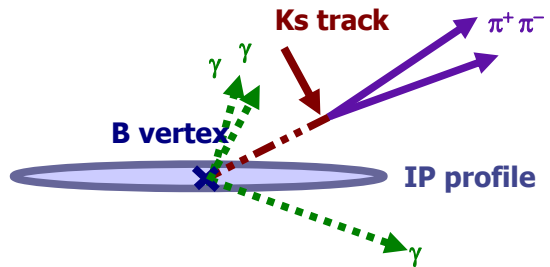

B decay point reconstruction
with K_S trajectory

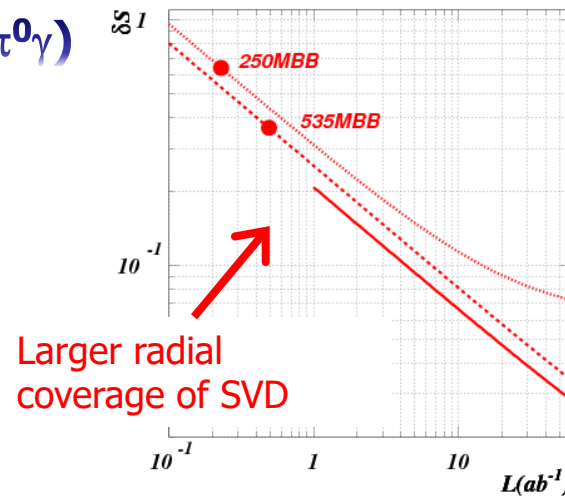

Belle II CDC

Wire Configuration

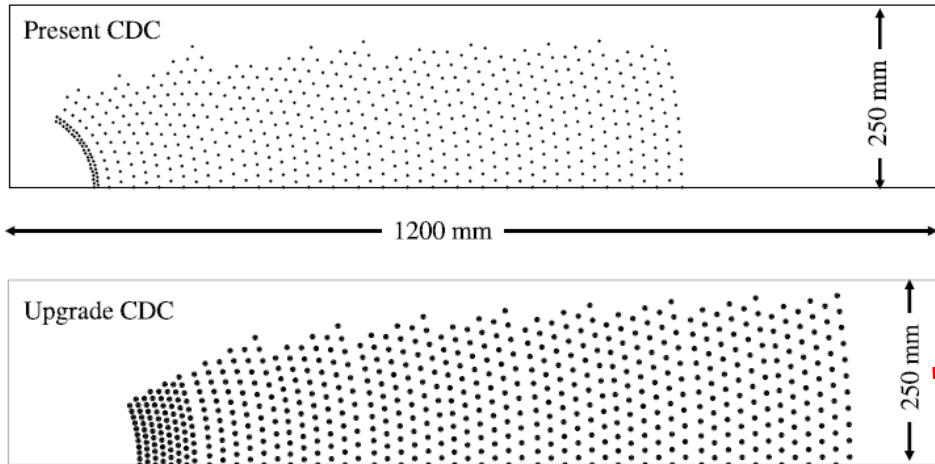

$$\frac{\sigma_{p_t}}{p_t} \sim 0.3\%/\beta \oplus 0.1\% \cdot p_t [GeV/c]$$

$$\sigma \left(\frac{dE}{dx} \right) \Big|_{MIP} \sim 5\%$$

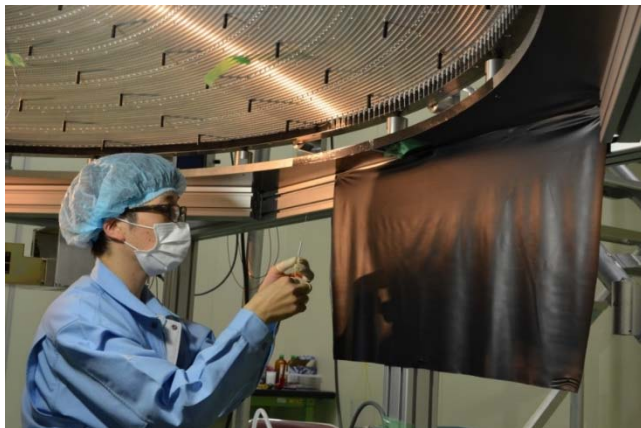

Wire stringing in a clean room

- thousands of wires,
- 1 year of work...

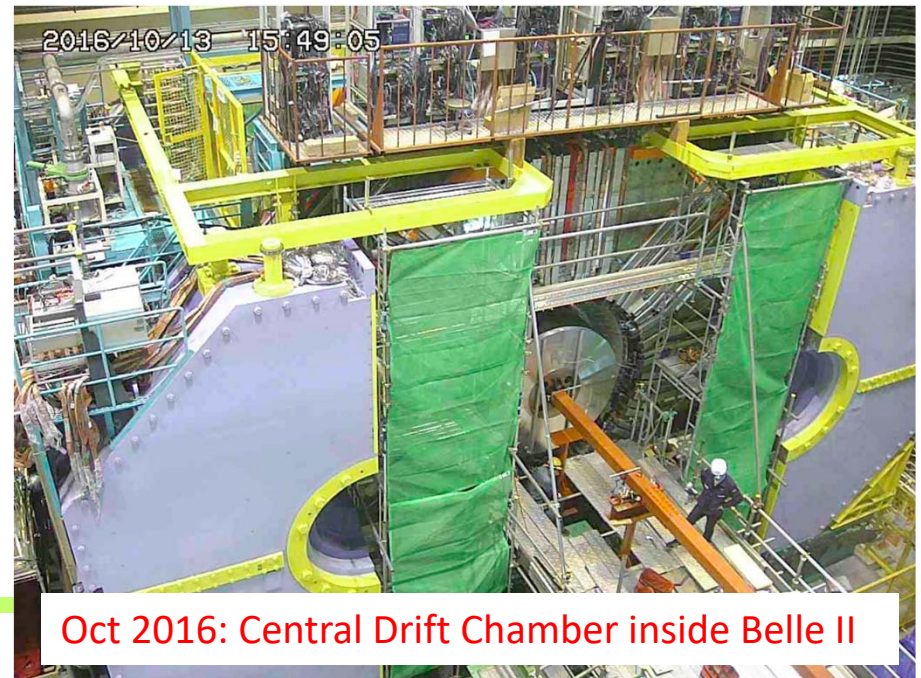

CDC event displays

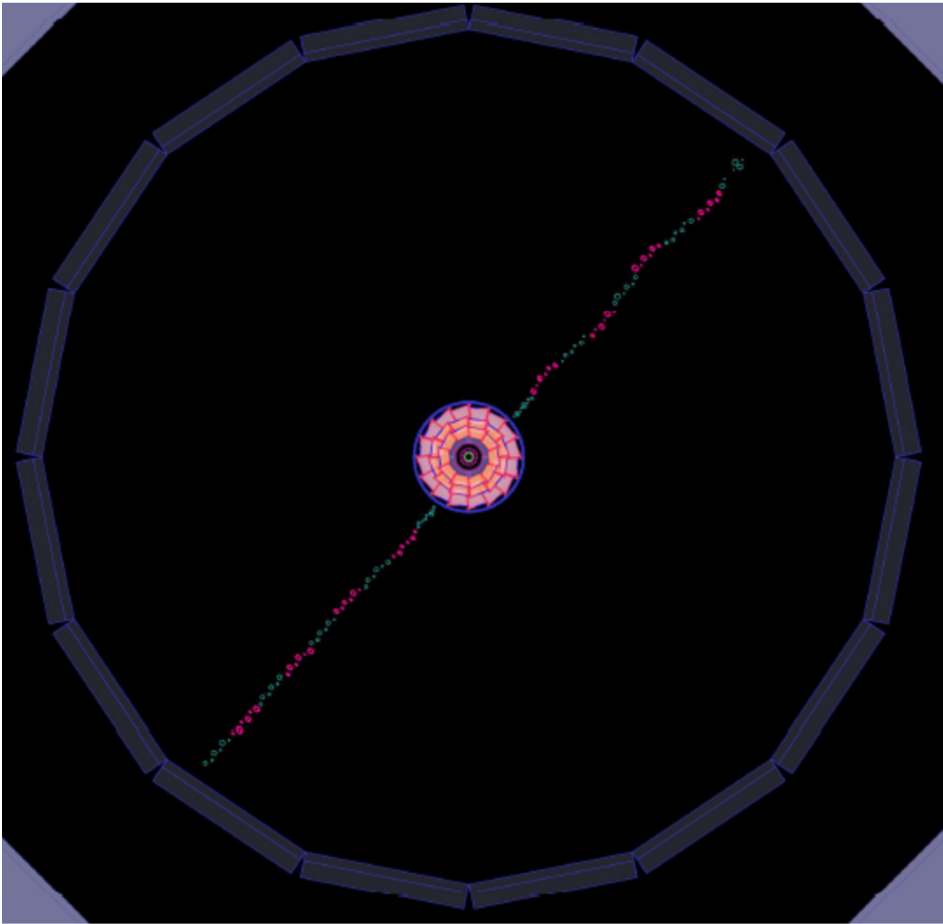

Single cosmic ray track

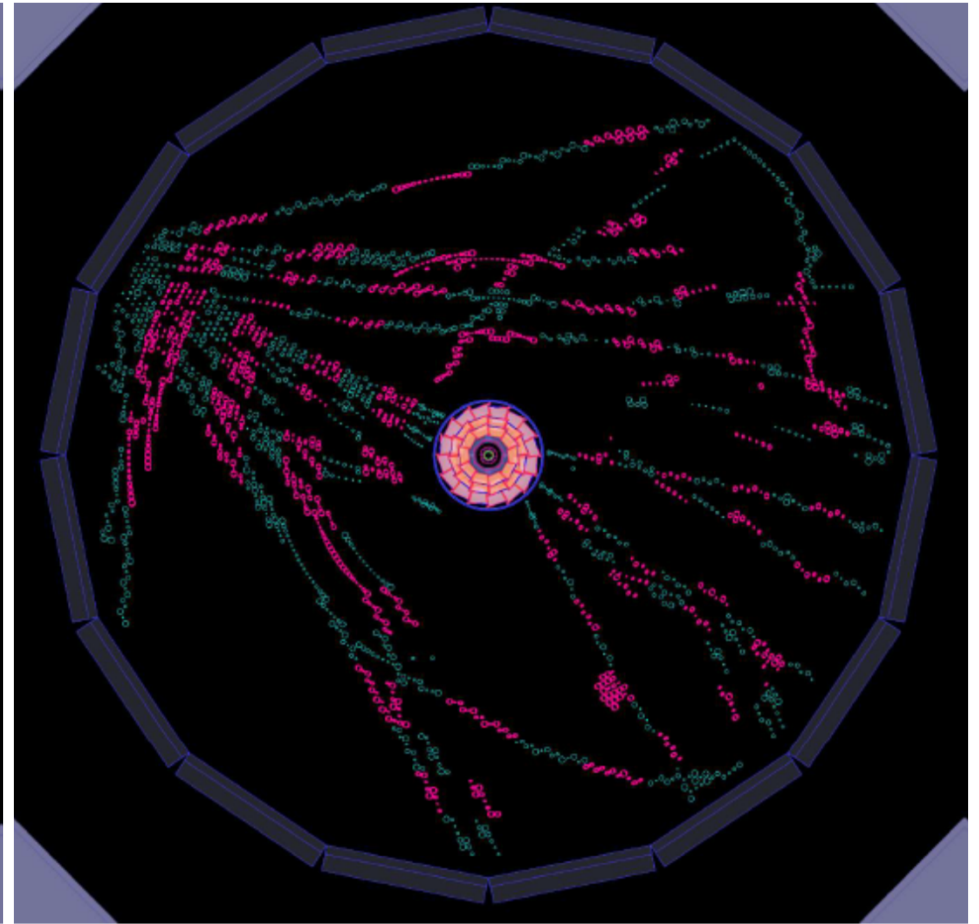

Multiple tracks
(showering cosmic ray event)



Particle Identification Devices

Barrel PID: Time of Propagation Counter (TOP)

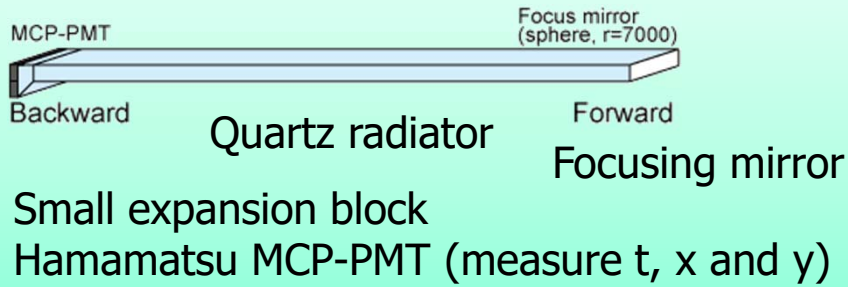

Endcap PID: Aerogel RICH (ARICH)

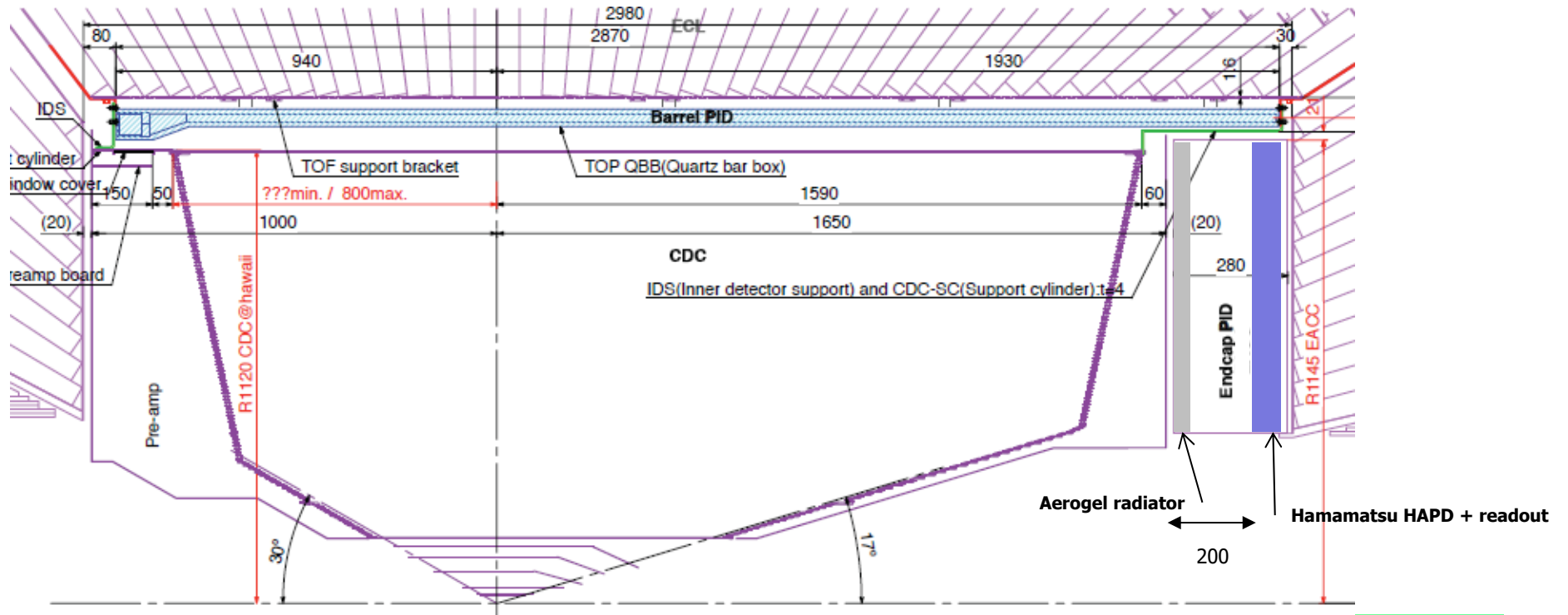
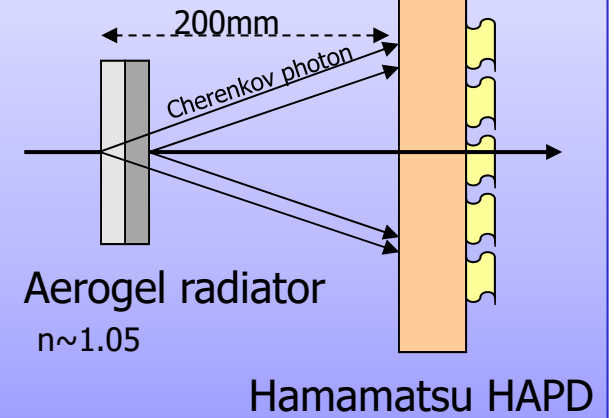

Peter Križan, Ljubljana

Aerogel RICH (endcap PID)

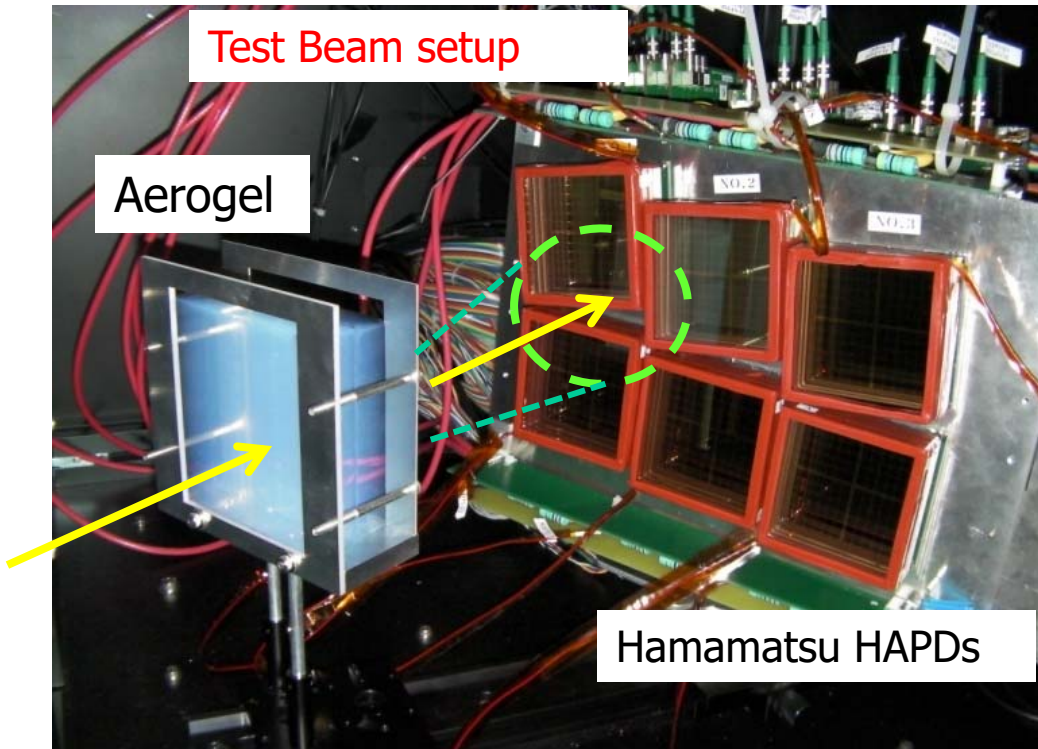

RICH with a novel "focusing" radiator – a two layer radiator

Employ multiple layers with different refractive indices → Cherenkov images from individual layers overlap on the photon detector.

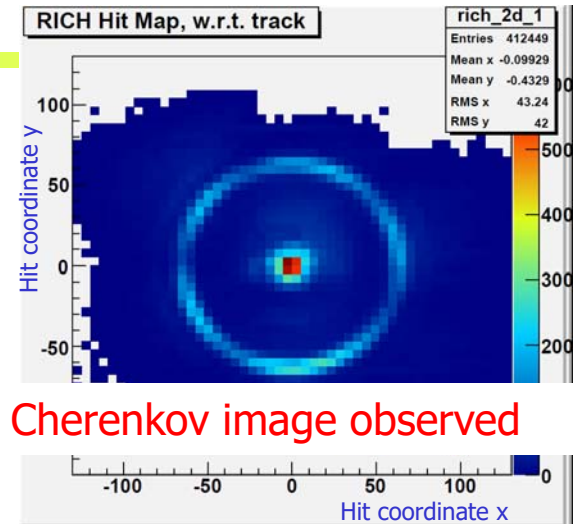
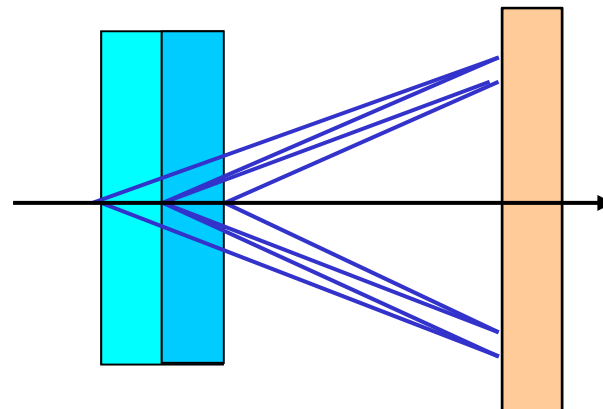

Clear Cherenkov image observed

Cherenkov angle distribution

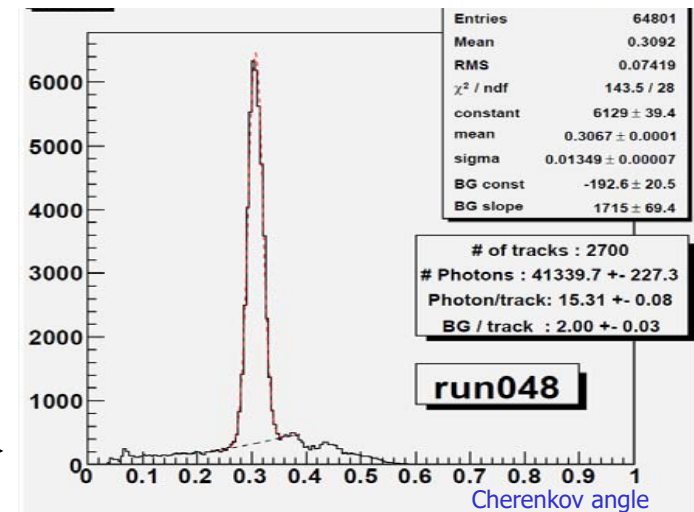

6.6 σ π/K at 4GeV/c !

Peter Križan, Ljubljana



Focusing configuration – data

Increases the number of photons without degrading the resolution

4cm aerogel single index

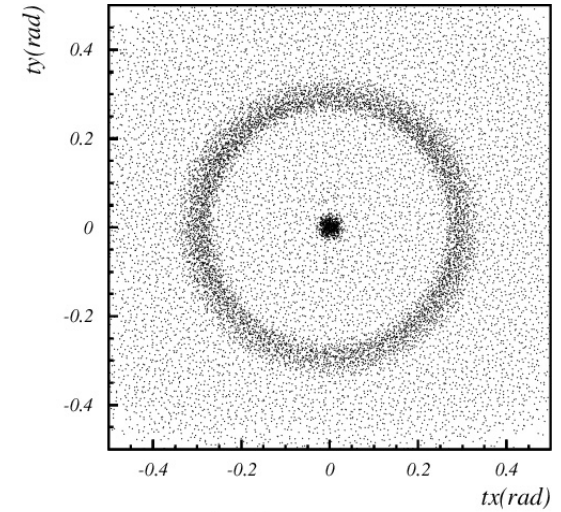
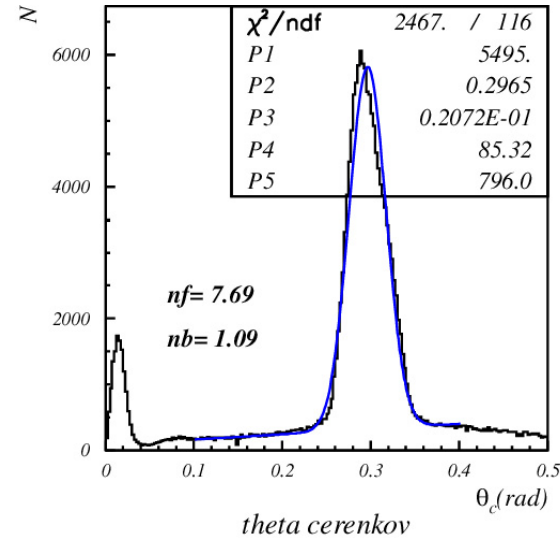
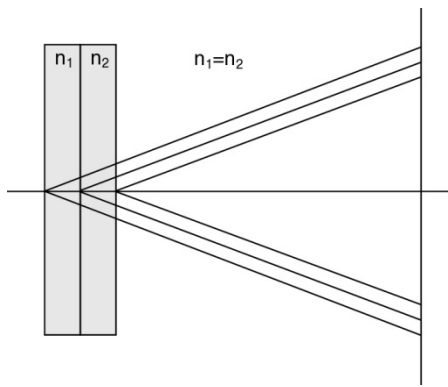

ring in cerenkov space

2+2cm aerogel

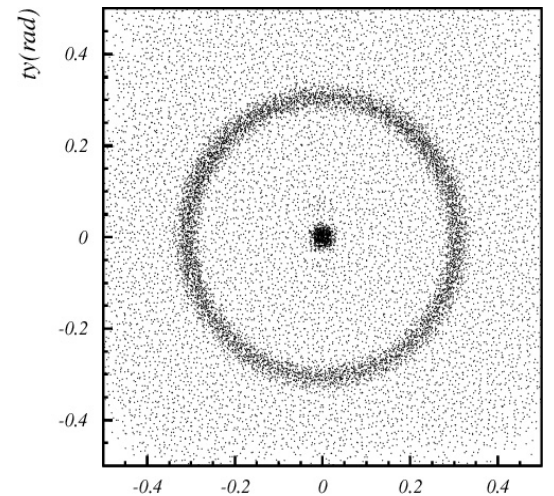
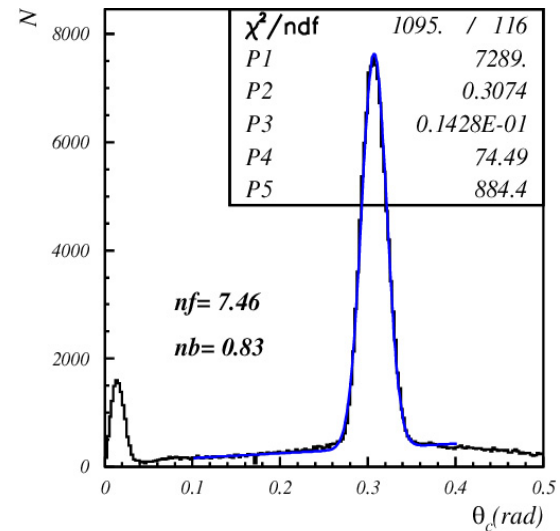
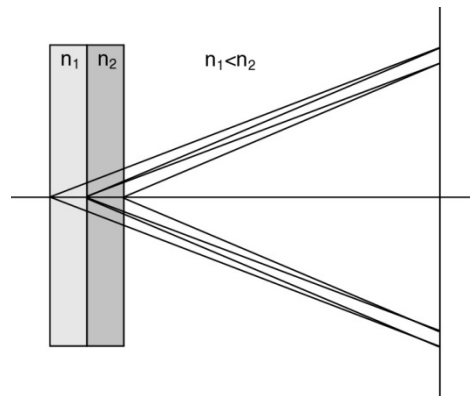

ring in cerenkov space

→ NIM A548 (2005) 383

The big eye of ARICH

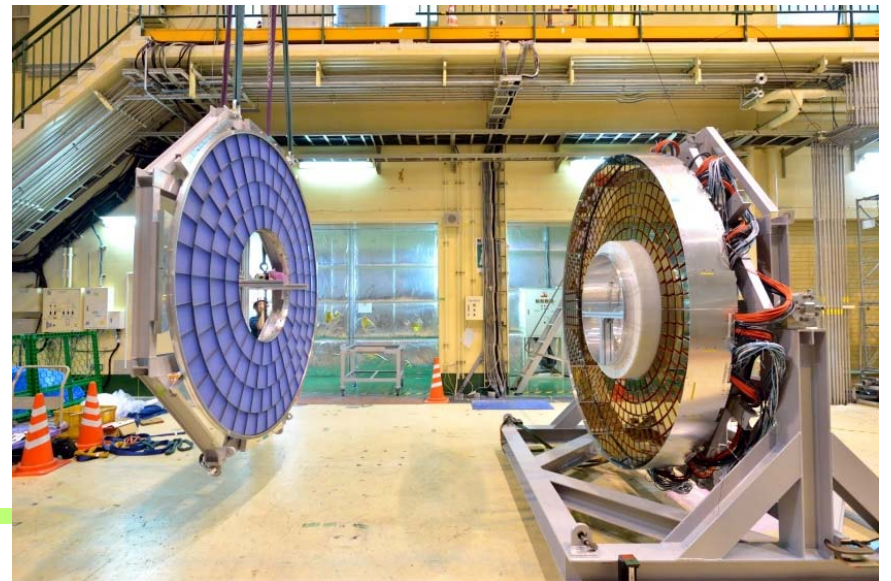
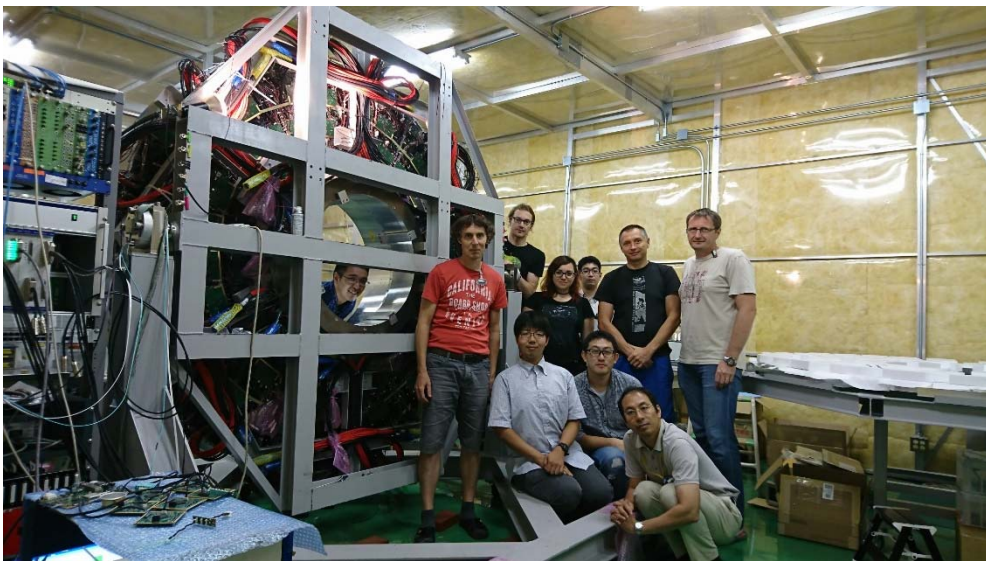
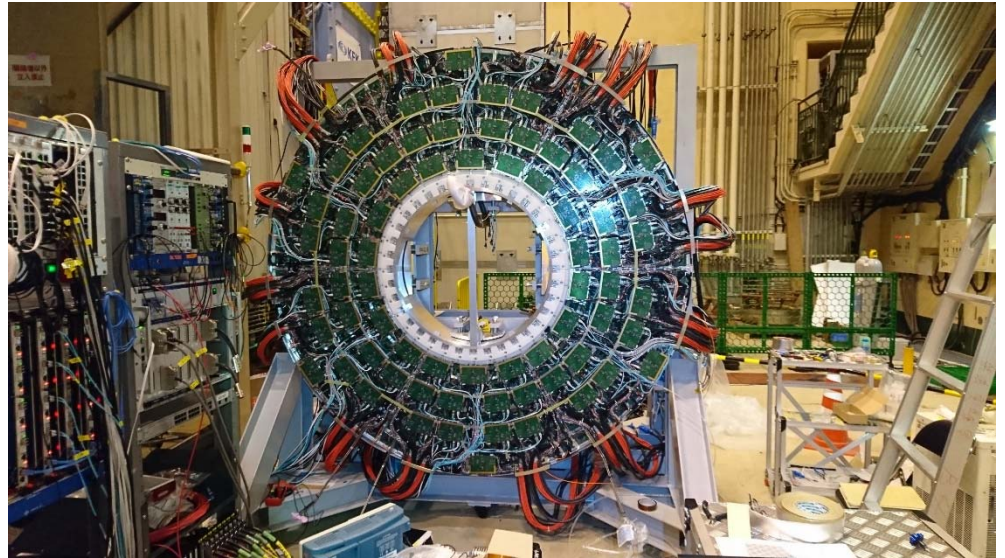
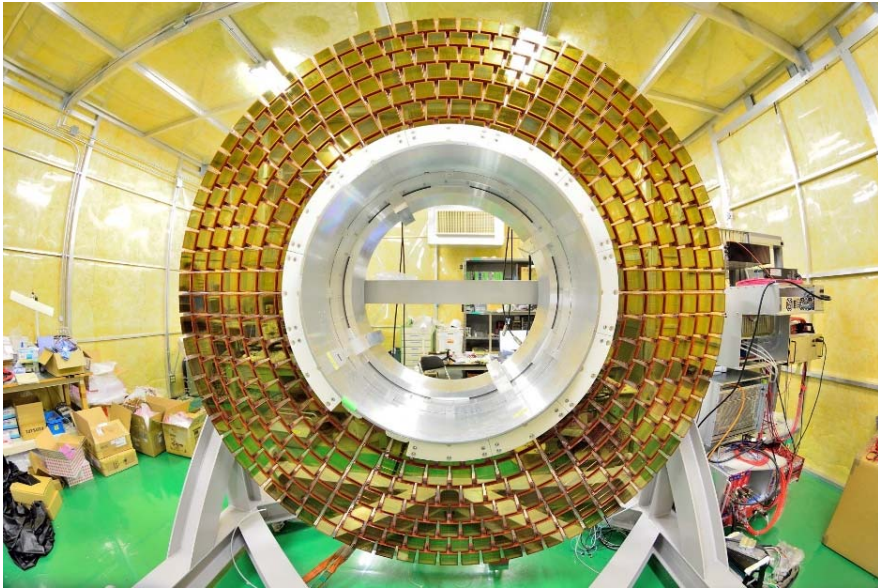

Cherenkov detectors

Barrel PID: Time of Propagation Counter (TOP)

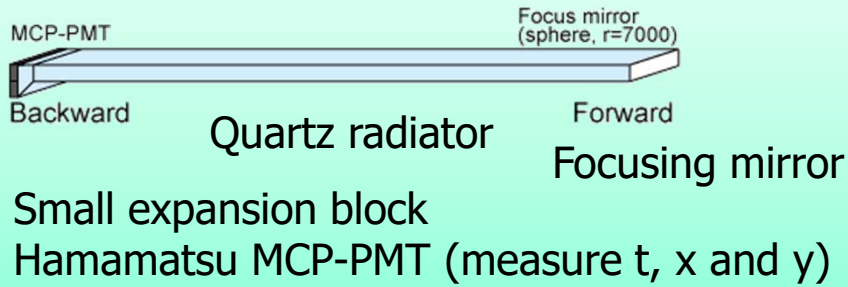

Endcap PID: Aerogel RICH (ARICH)

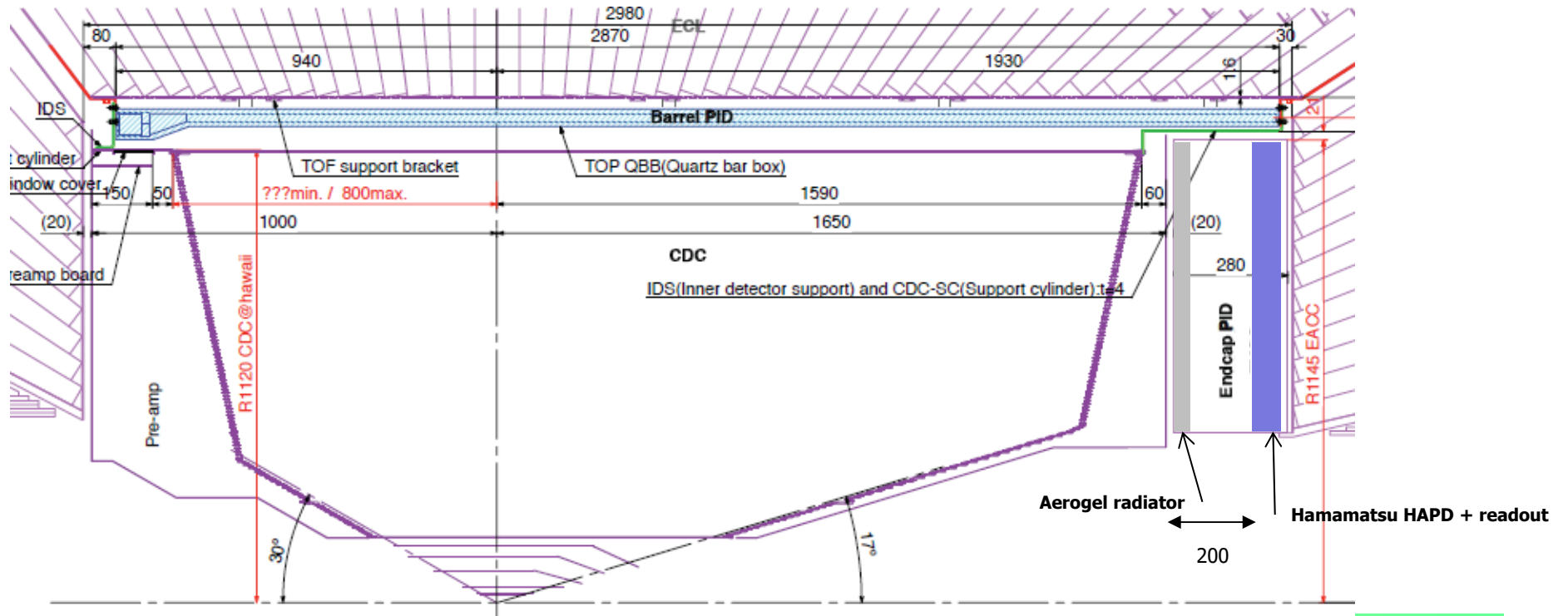
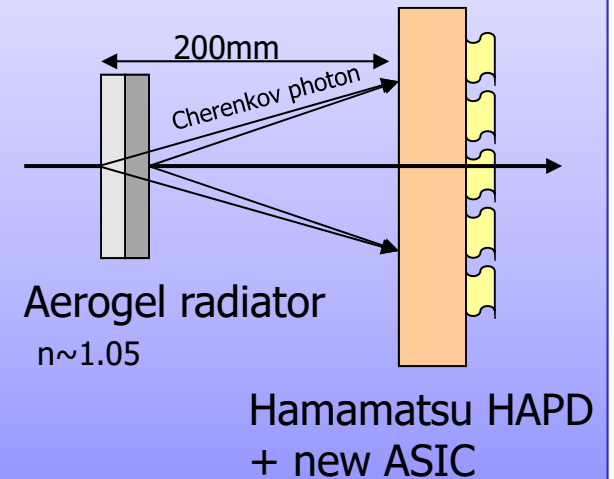

Barrel PID: Time of propagation (TOP) counter

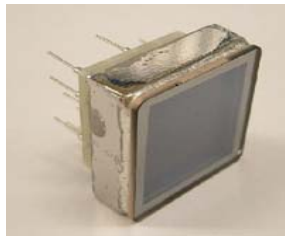
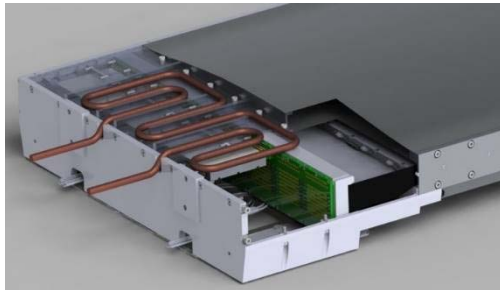

Photon detector

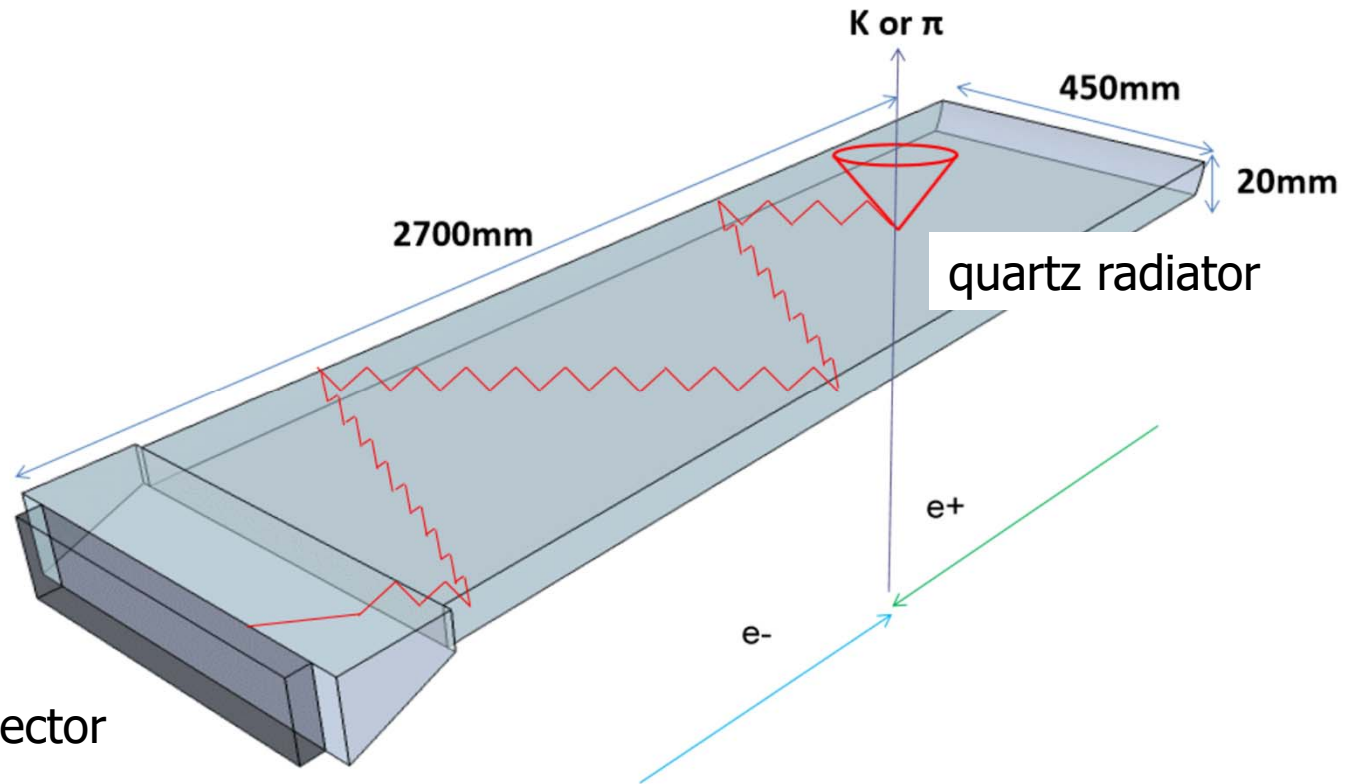

- Cherenkov ring imaging with precise time measurement.
- Reconstruct Cherenkov angle from two hit coordinates and the time of propagation of the photon
 - Quartz radiator (2cm thick)
 - Photon detector (MCP-PMT)
 - Excellent time resolution ~ 40 ps
 - Single photon sensitivity in 1.5 T

Separation of kaons and pions

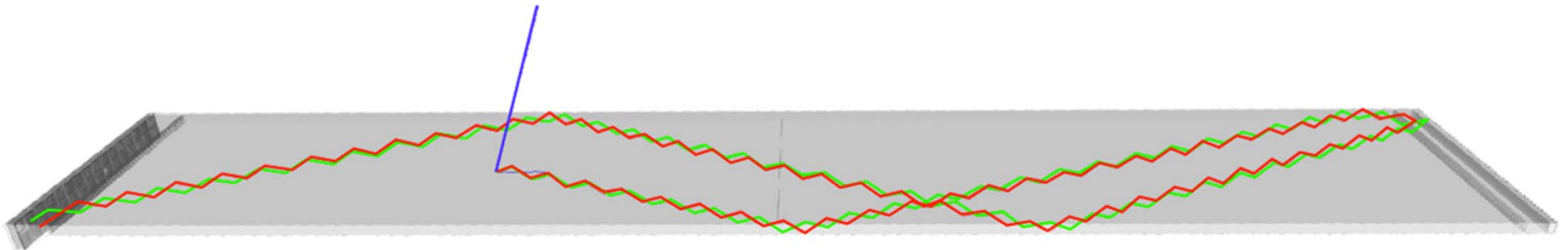

Pions vs kaons in TOP:
different patterns in the time vs
PMT impact point coordinate

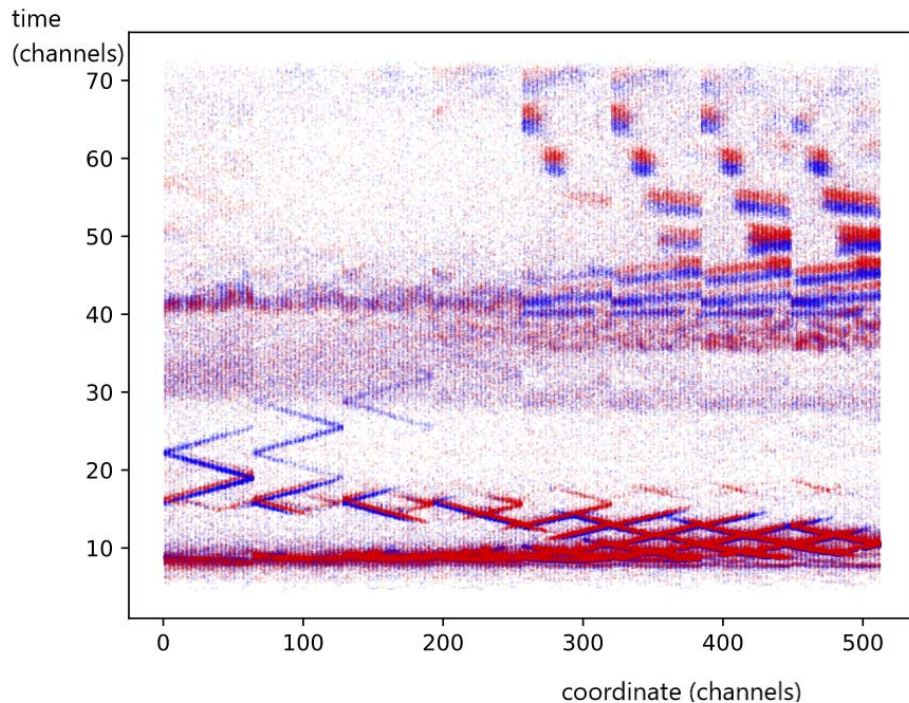

Pions vs kaons:
Expected PID efficiency and
misidentification probability.

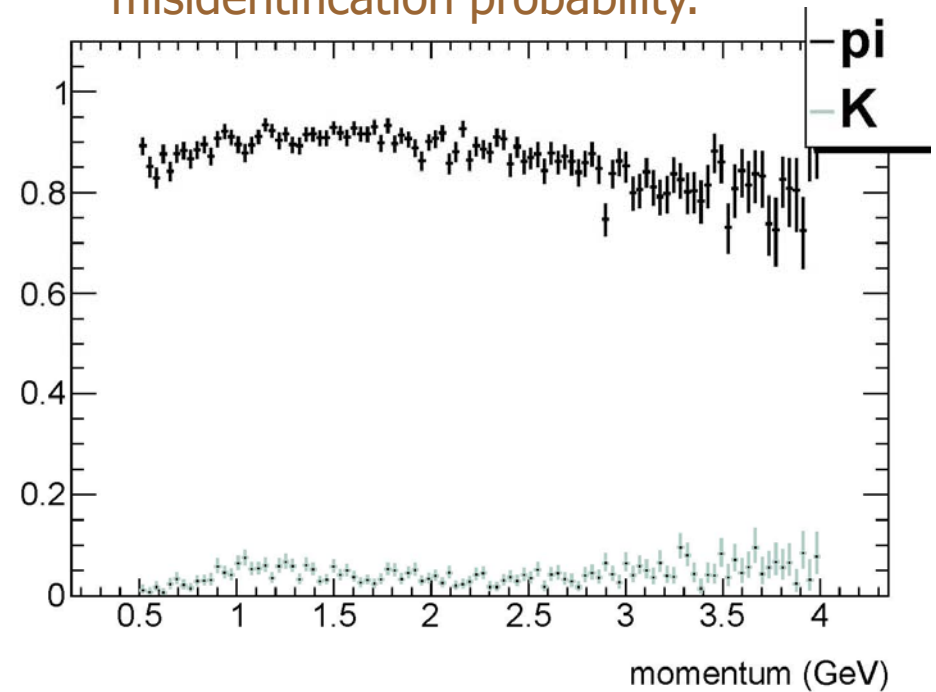

EM calorimeter: upgrade needed because of higher rates (electronics \rightarrow waveform sampling) and radiation load (endcap, replace some fraction of crystals, CsI(Tl) \rightarrow pure CsI)

EM Calorimeter:
CsI(Tl), waveform sampling (barrel)
Pure CsI (part of end-caps)

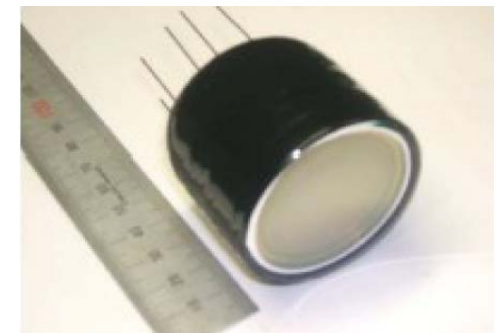
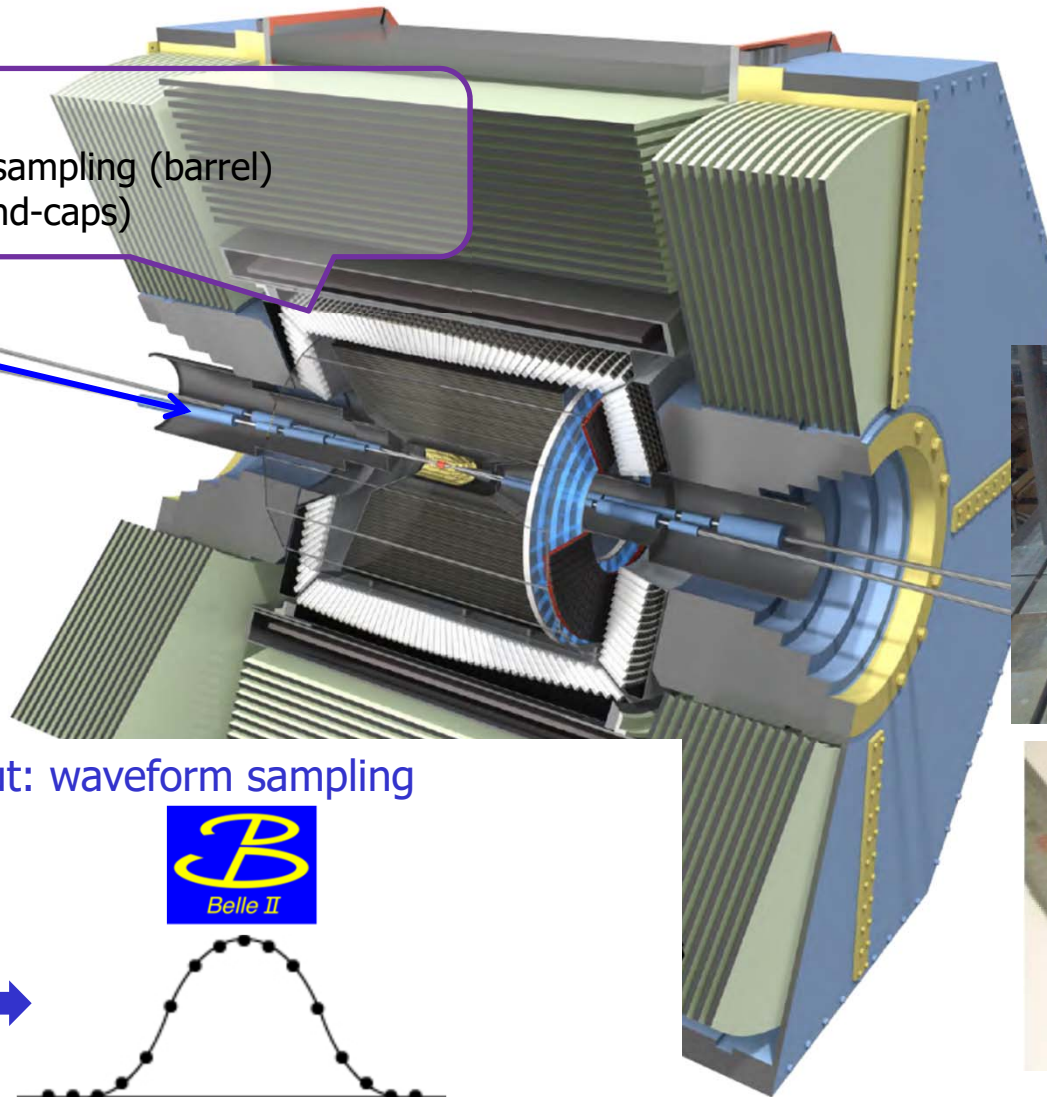

New read-out: waveform sampling

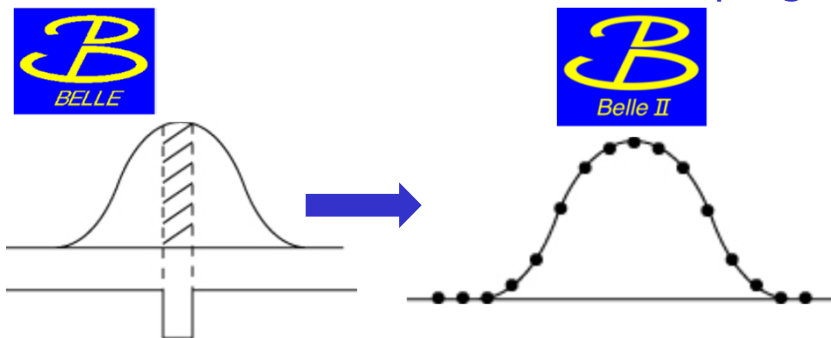

ECL: endcap installation, testing with cosmic ray tracks, expected performance

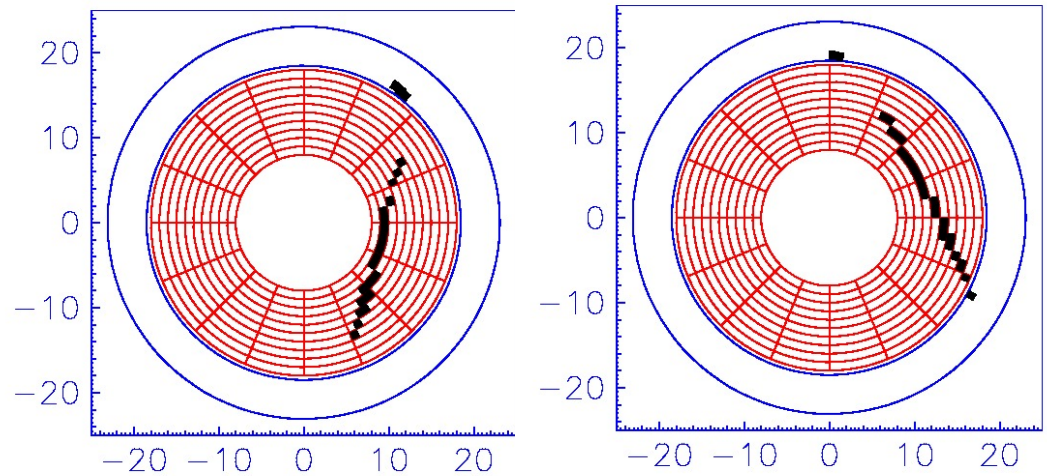
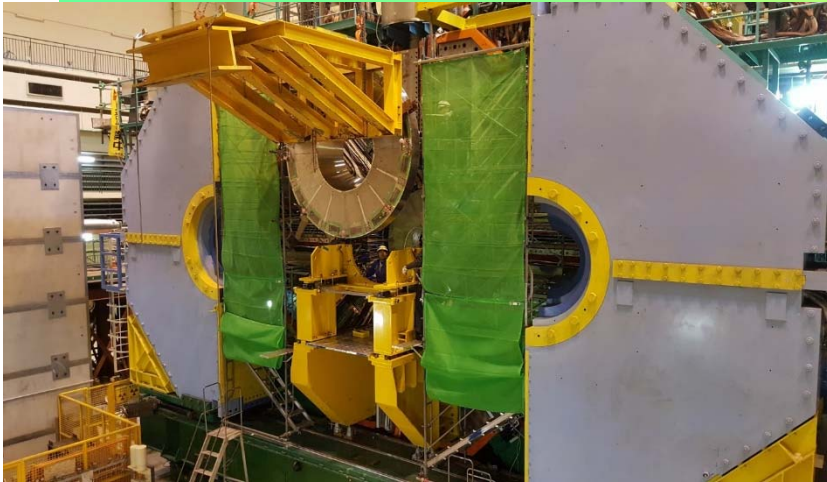

Measured time resolution

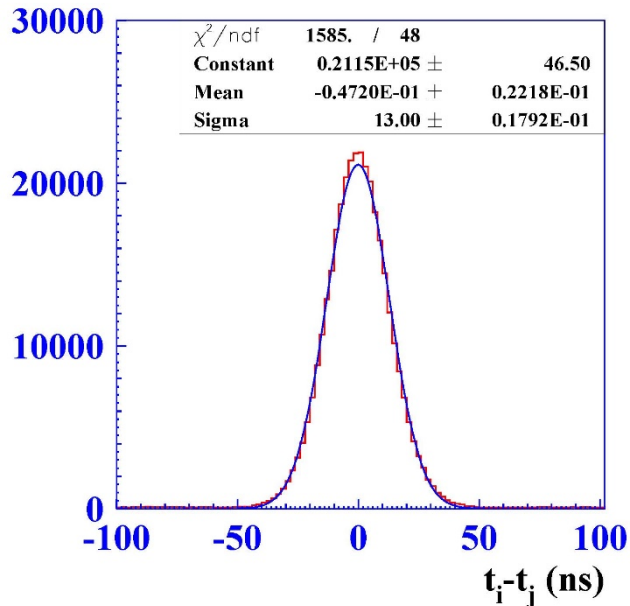

Expected energy resolution

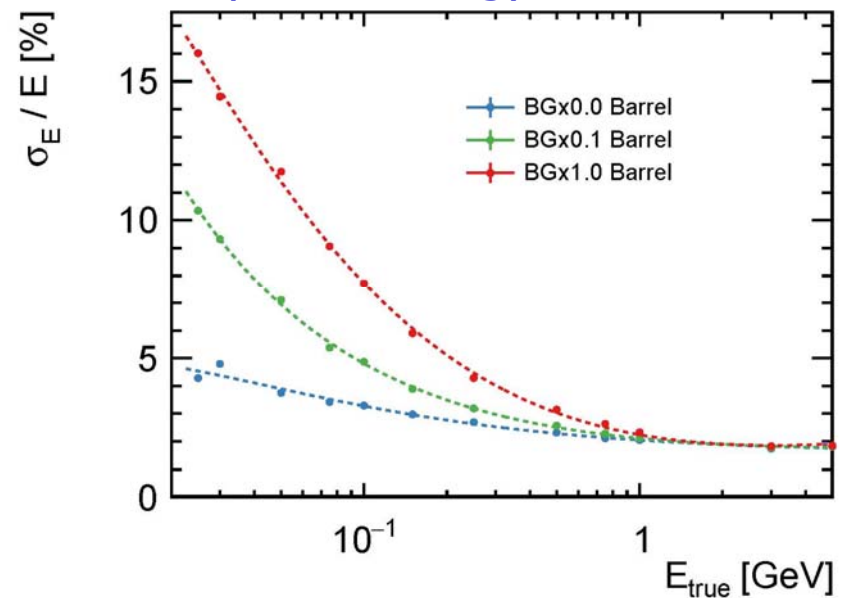

Detection of **muons and K_L s**: mainly RPCs; parts of the original RPC system had to be replaced because they could not handle the high background rates (mainly neutrons)

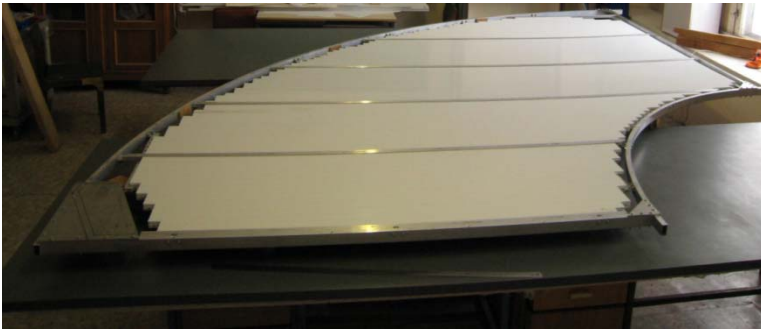

K_L and muon detector:
Resistive Plate Counter (barrel)
Scintillator + WLSF + MPPC (end-caps + 2 layers in the barrel)

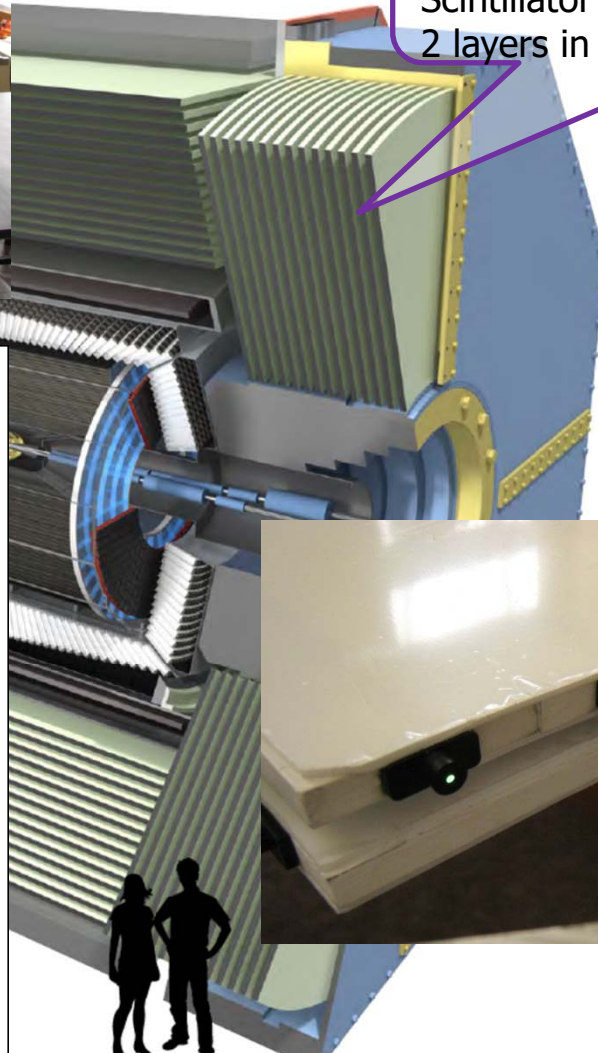
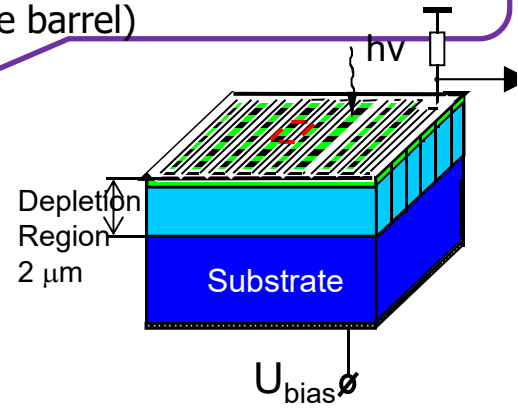

Exp 3 Run 52 Farm 2 Event 10267
Eher 8.00 Eler 3.50 Date/TIME Wed Jun 9 21z28z04 1999
TrgID 0 DetVer 0 MagID 0 BField 1.50 DepVer 0.04

Trk	E	Theta	$\langle ECL \rangle$	PFI	match	aid
1	0.018	14.7	41.1	0	0	0
2	0.090	15.9	310.7	0	0	0
3	0.409	18.7	28.8	0	0	0
4	0.013	18.2	347.8	0	0	0
5	0.080	18.0	52.3	0	0	0
6	0.181	28.0	56.3	7	0	0
7	0.059	30.7	288.5	0	0	0
8	0.477	40.9	189.6	0	0	0
9	0.204	43.2	60.8	5	0	0
10	0.339	45.2	67.5	5	0	0
11	2.018	59.3	182.9	2	0	0
12	0.033	78.7	345.1	0	0	0
13	0.221	81.8	3.1	1	0	0
14	0.286	84.4	337.4	4	0	0
15	0.218	88.9	220.2	3	0	0
16	0.284	102.0	38.4	0	0	0

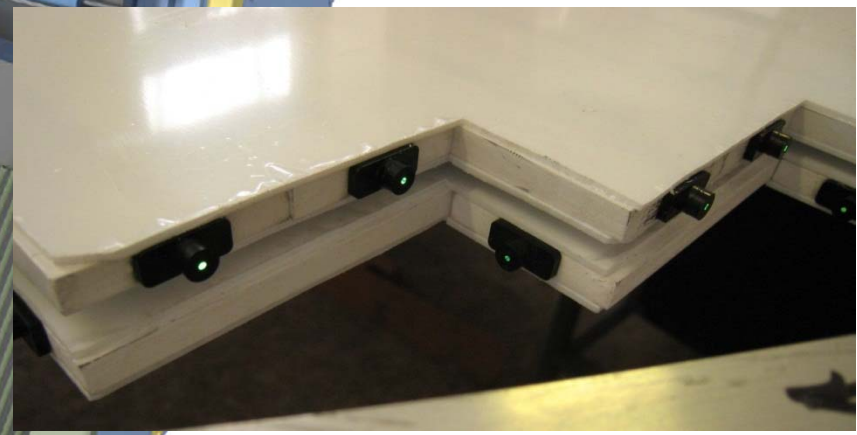
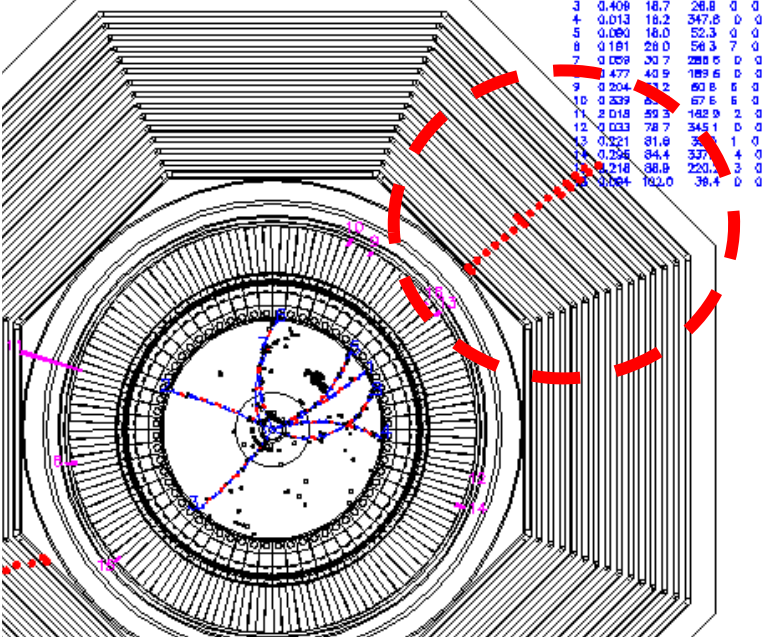

ljana

Muon detection system upgrade

Scintillator-based KLM (endcap in inner layers of the barrell part)

- Two independent (x and y) layers in one superlayer made of orthogonal strips with WLS read out
- Photo-detector = avalanche photodiode in Geiger mode (SiPM)
- ~ 120 strips in one 90° sector (max $L=280\text{cm}$, $w=25\text{mm}$)
- ~ 30000 read out channels
- Geometrical acceptance $> 99\%$

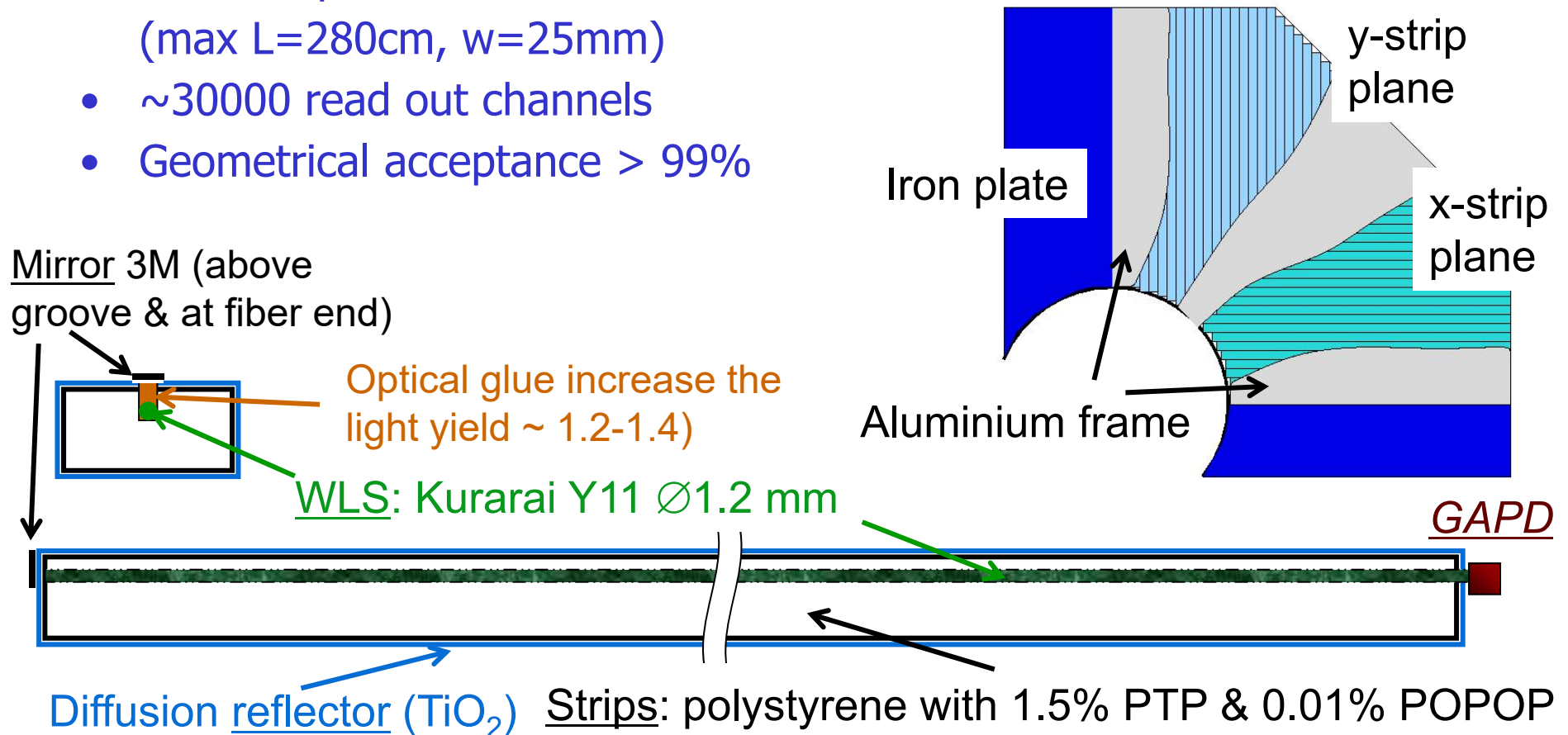

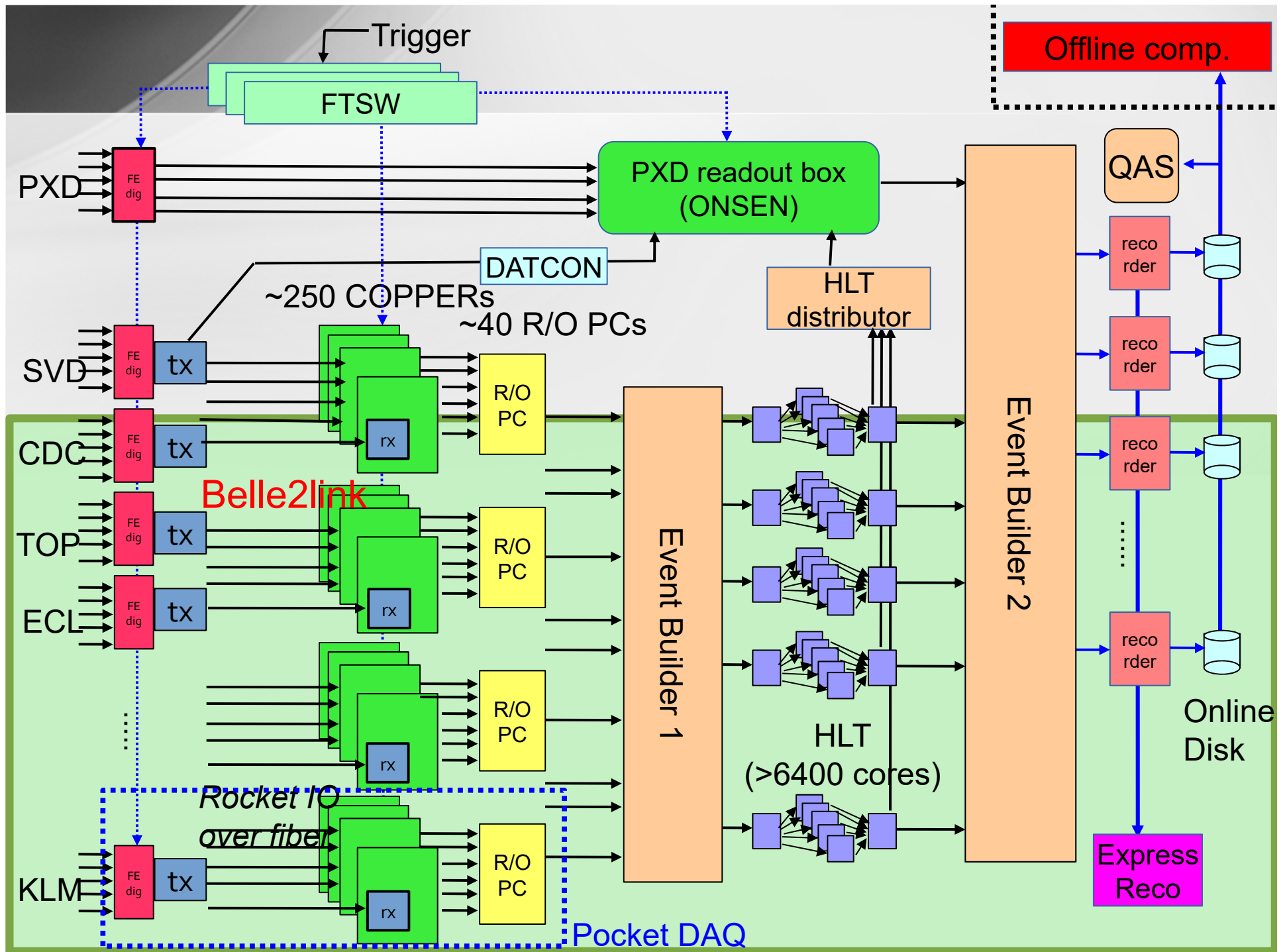

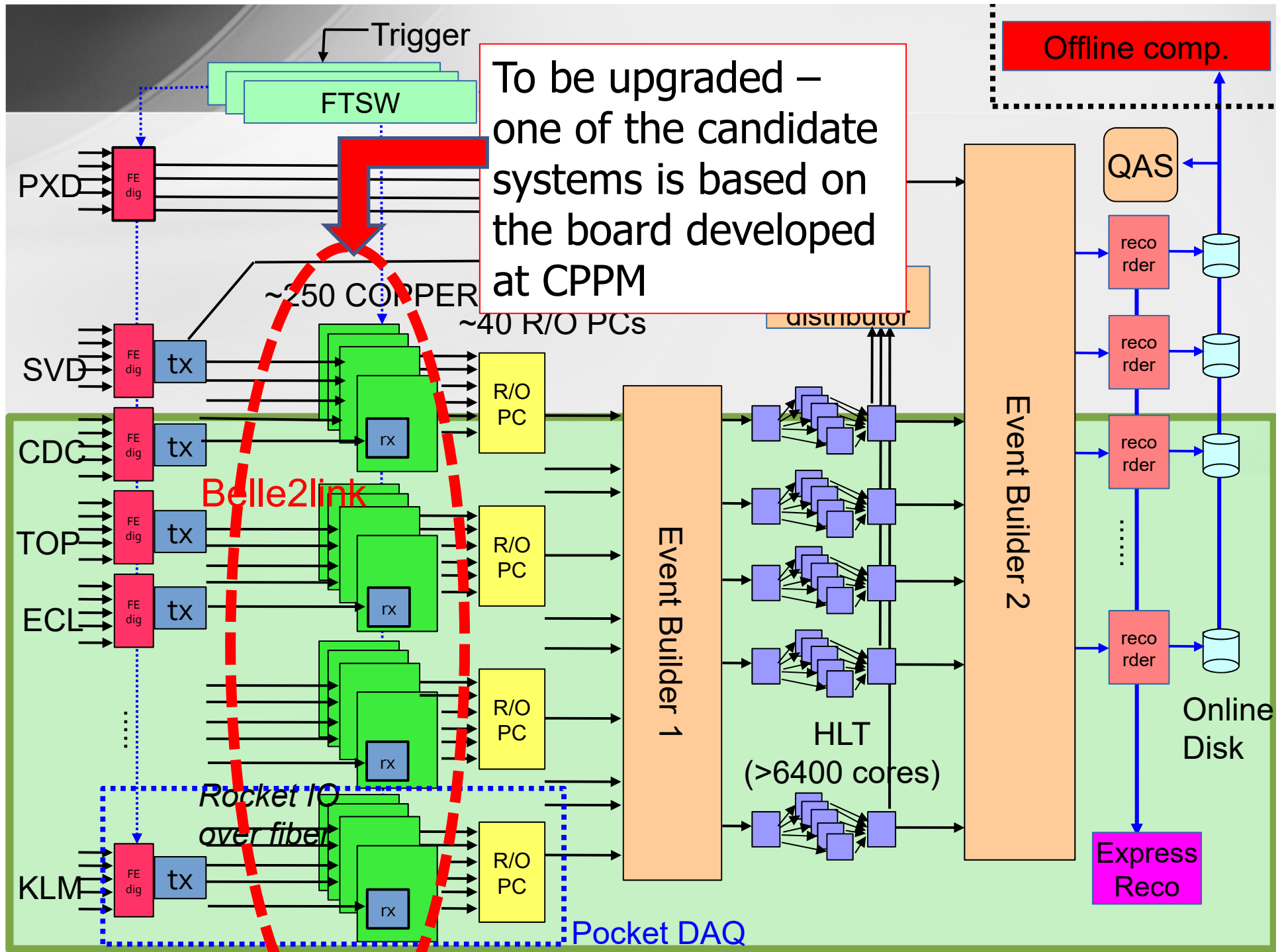

Getting ready...

SuperKEKB commissioning phase 1: BEAST II commissioning detector

Commissioning (Phase 1) of the main ring (without final quads) successfully carried out from Feb 1, 2016 – end of June 2016

Interaction point detector:
instead of Belle II, a
commissioning detector –
BEAST II.

→ a 100 page report
published in NIMA

<https://doi.org/10.1016/j.nima.2018.05.071>



Belle II Roll-in

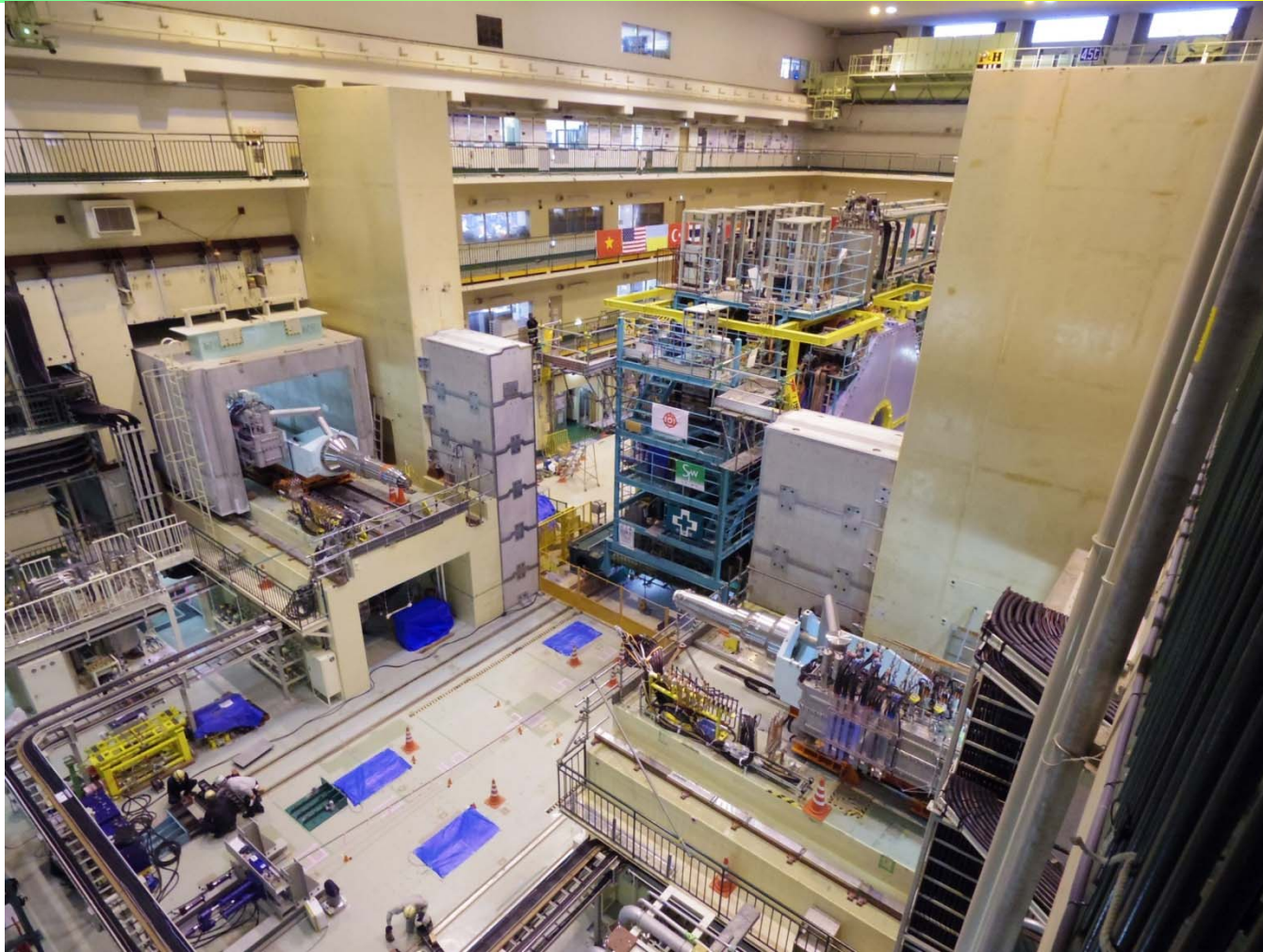

Belle II rolled-in to the beam line on April 11th, 2017

One of the most significant milestones in the construction phase

Live broadcasted by a video sharing website



ARICH and forward endcap calorimeter transport and installation

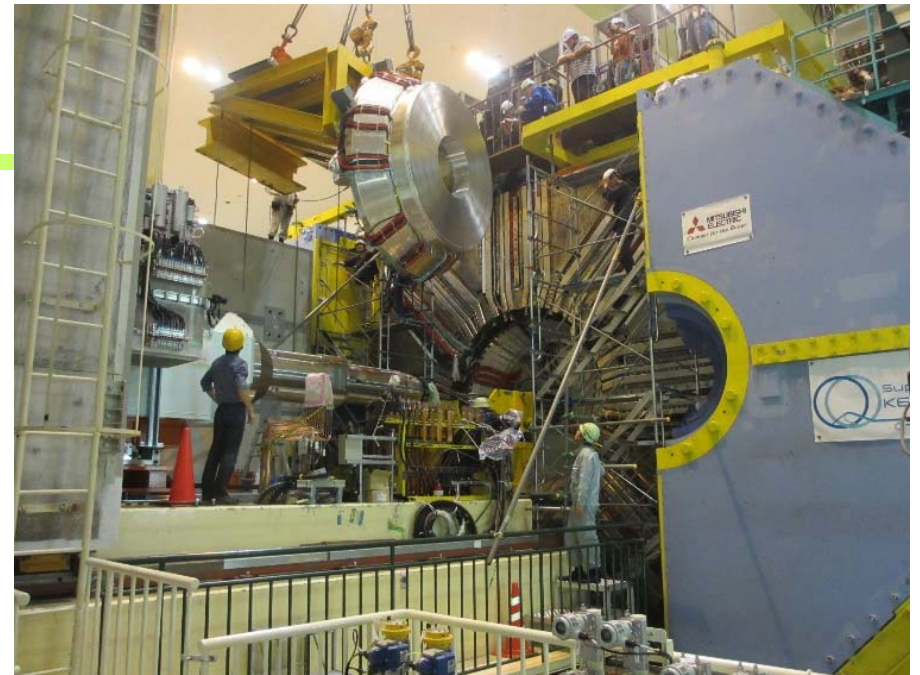

Installation of final quads

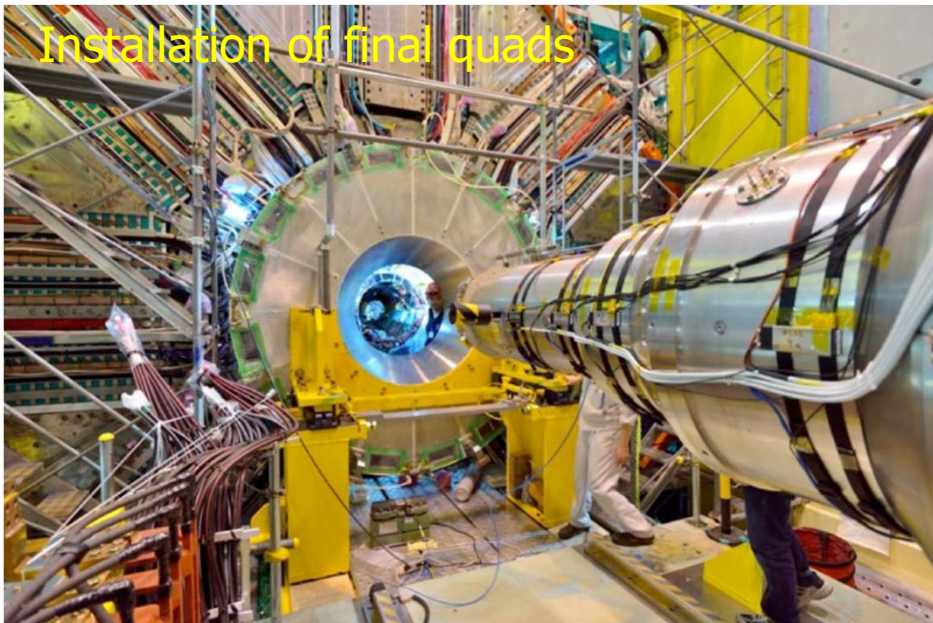

Installation of the commissioning vertex detector



Peter Križan, Ljubljana

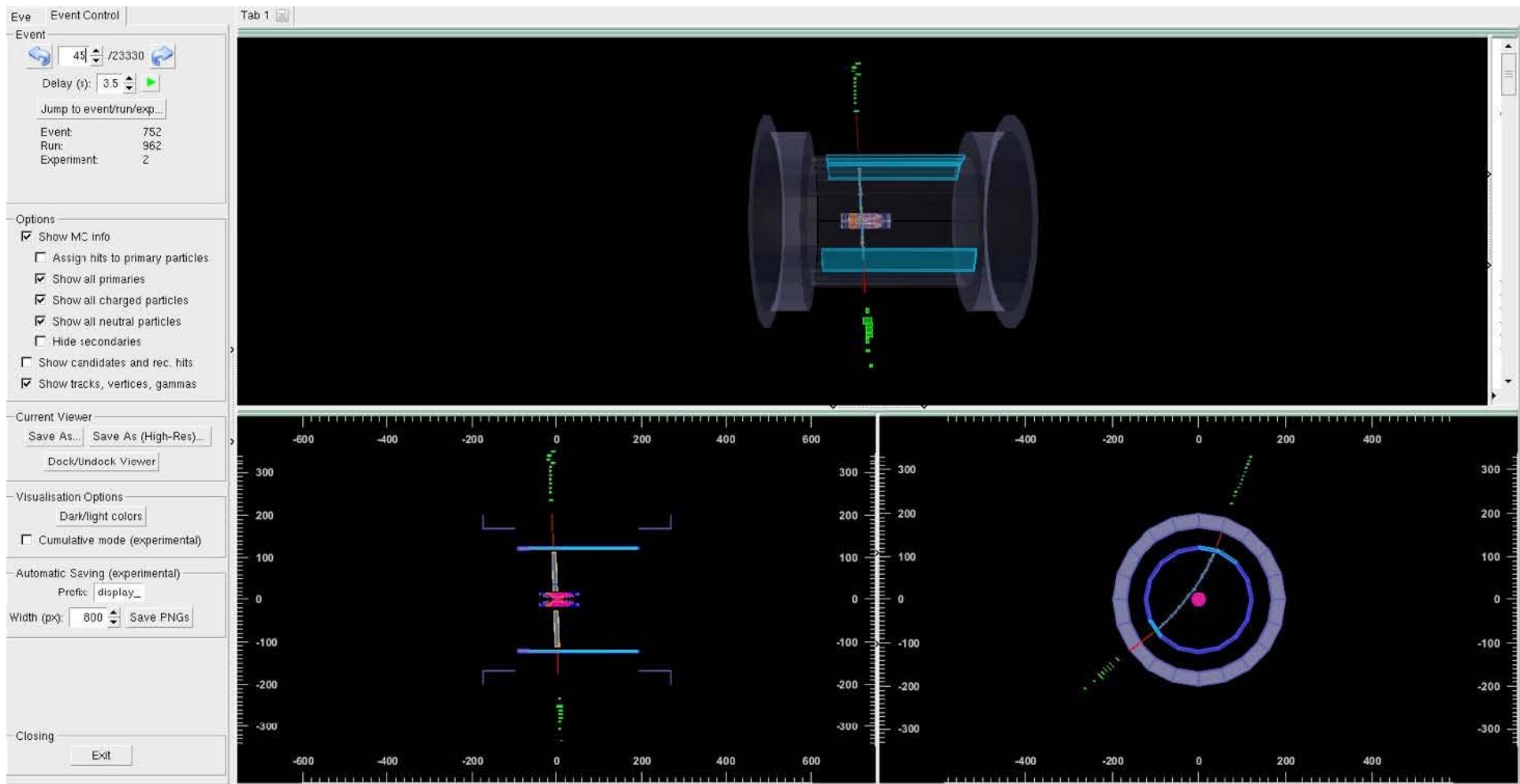

Four outer detector subsystems CDC, TOP, ECL, BKLM read out simultaneously

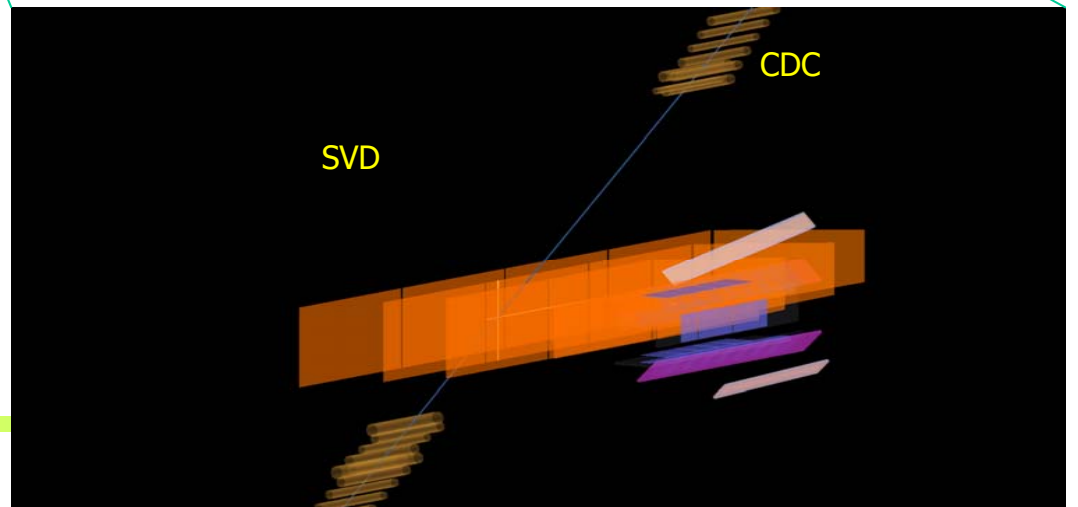
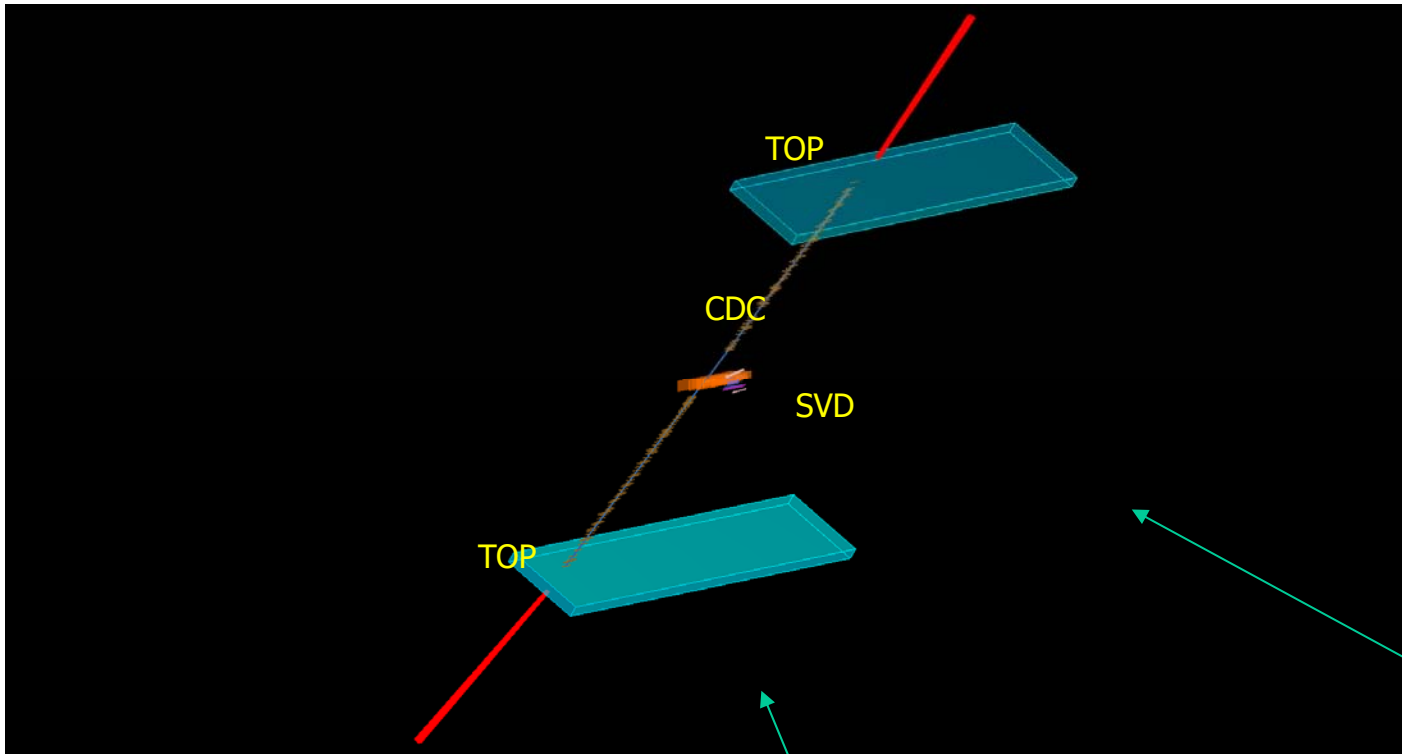

+ vertex
detector hits!

ARICH: Rings from cosmic ray muons

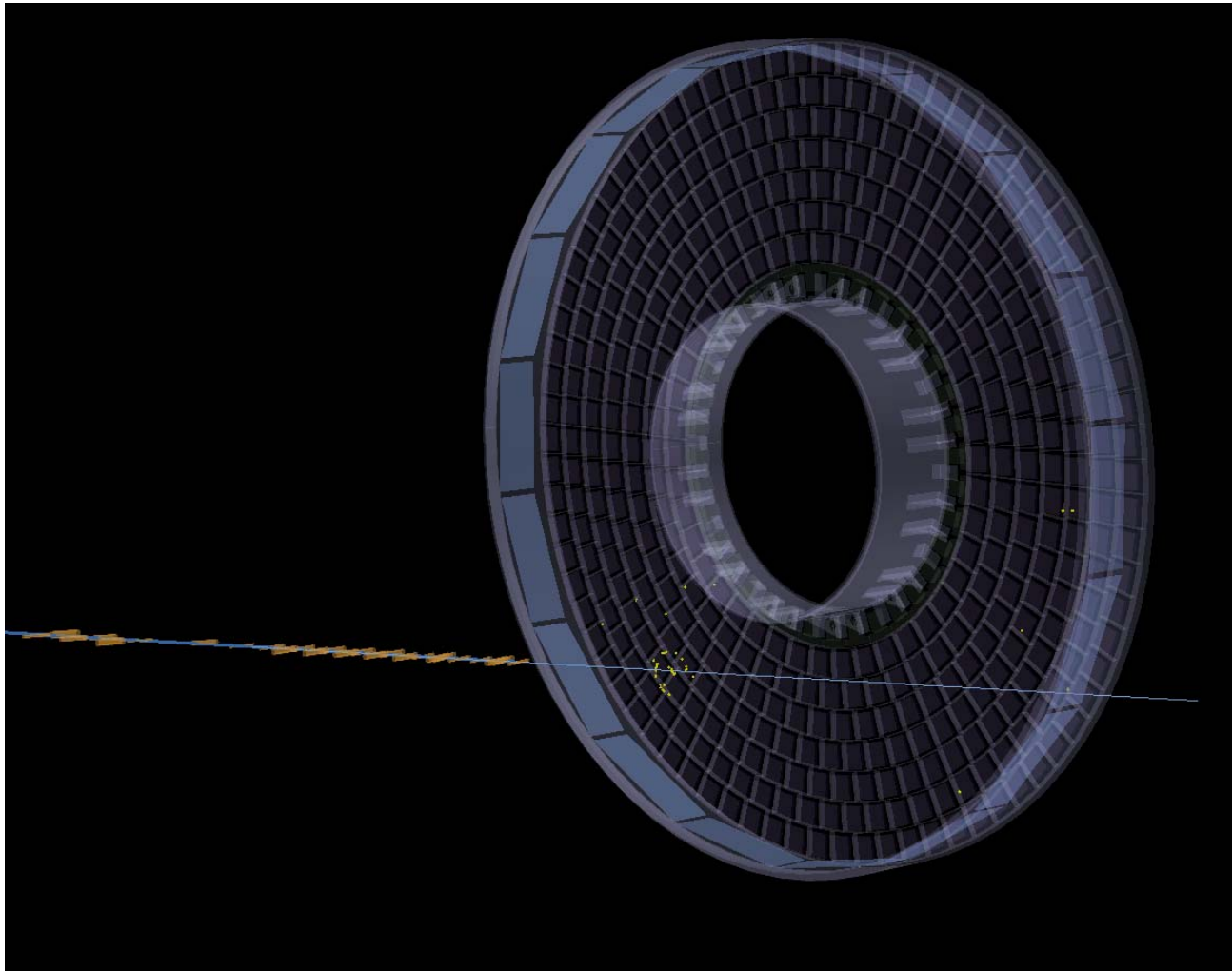

First events recorded in the fully instrumented ARICH.

Phase 2 vertex detector (BEAST II): test the subset of final detectors and study backgrounds

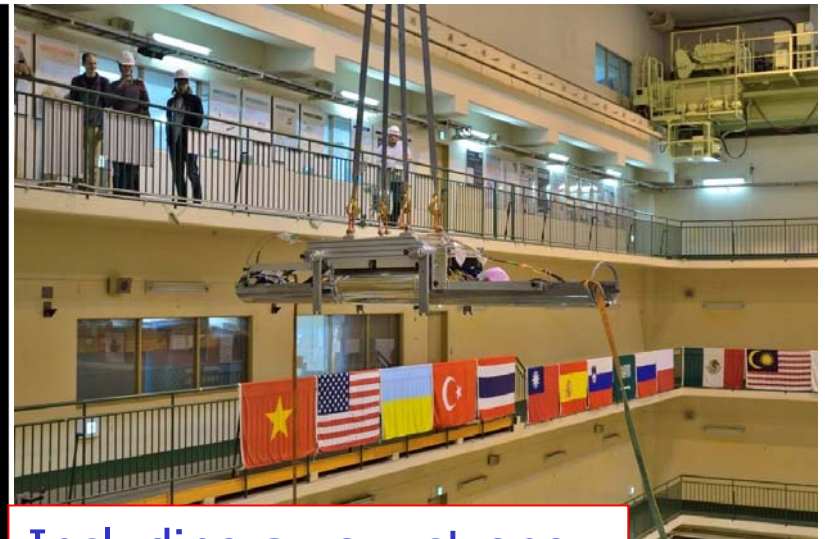
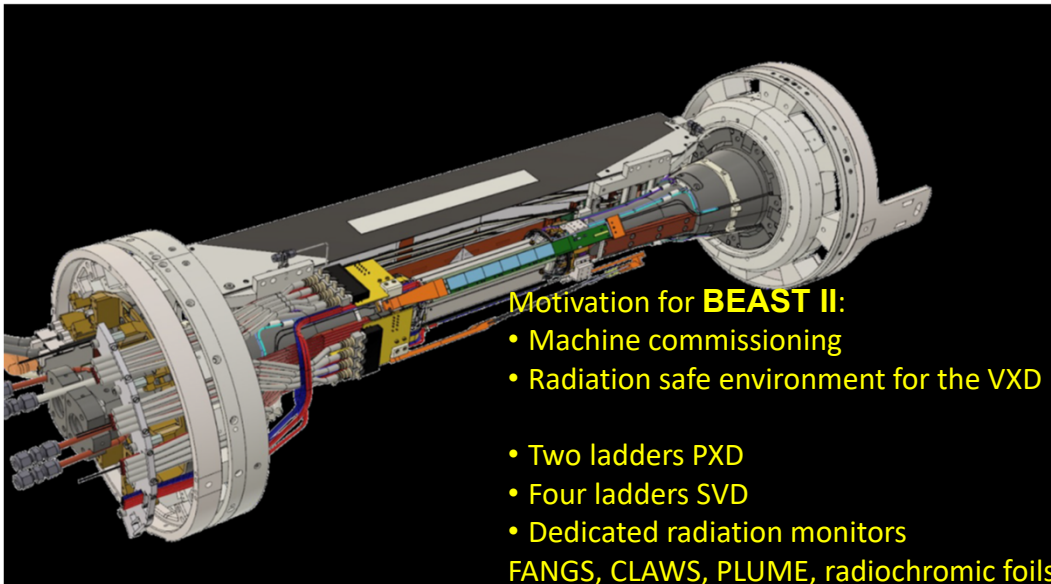

Including a very strong IPHC Strasbourg team

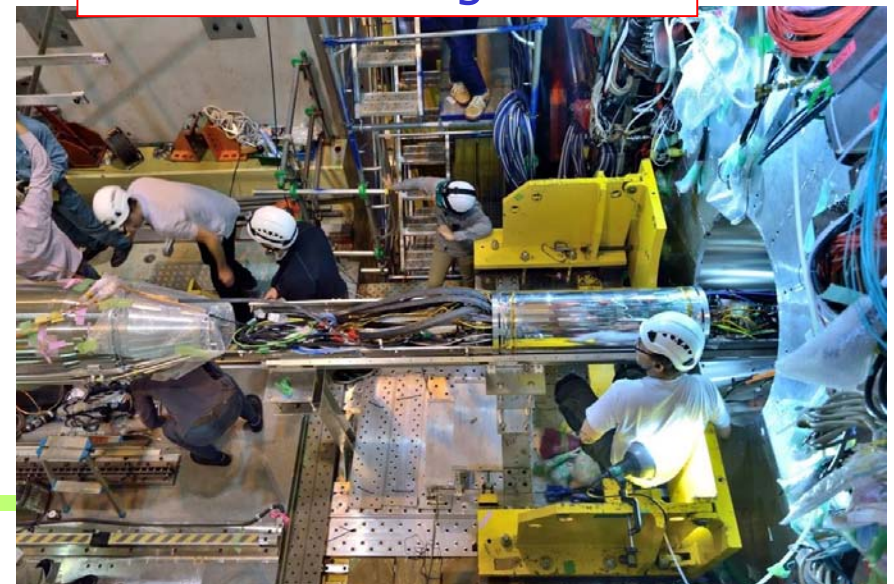
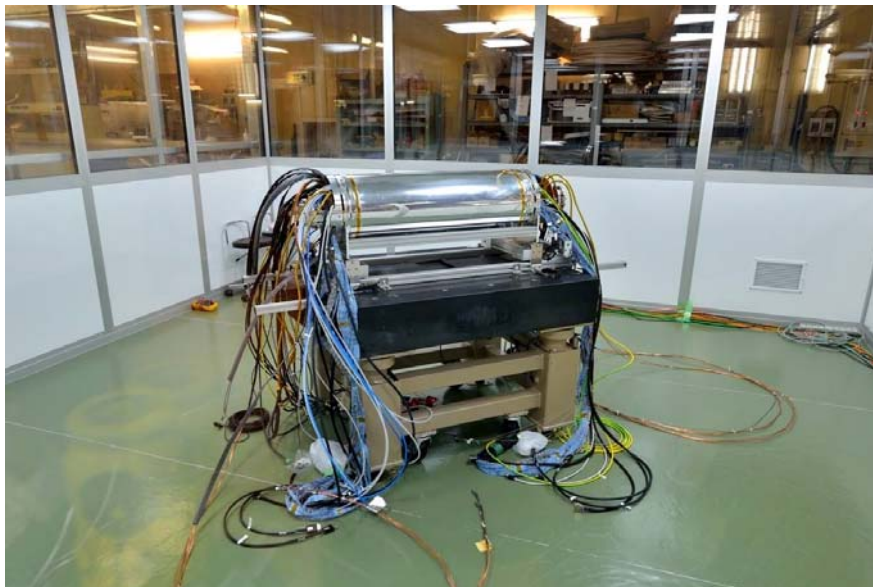

Naive
Phase 2
summary:

Keep on squeezing the two beams with the superconducting final focus down to $\beta_y^* = 3\text{mm}$, making sure that the two “thin pancakes” are well aligned. One then adds beam current.....

PEP-II design
luminosity 3×10^{33}

$$L_{peak} = 5.5 \times 10^{33} / \text{cm}^2 / \text{sec}$$

Phase 2,
July 2018

N.B. Still a long way to go with the superconducting final focus (one order of magnitude in β_y^*)

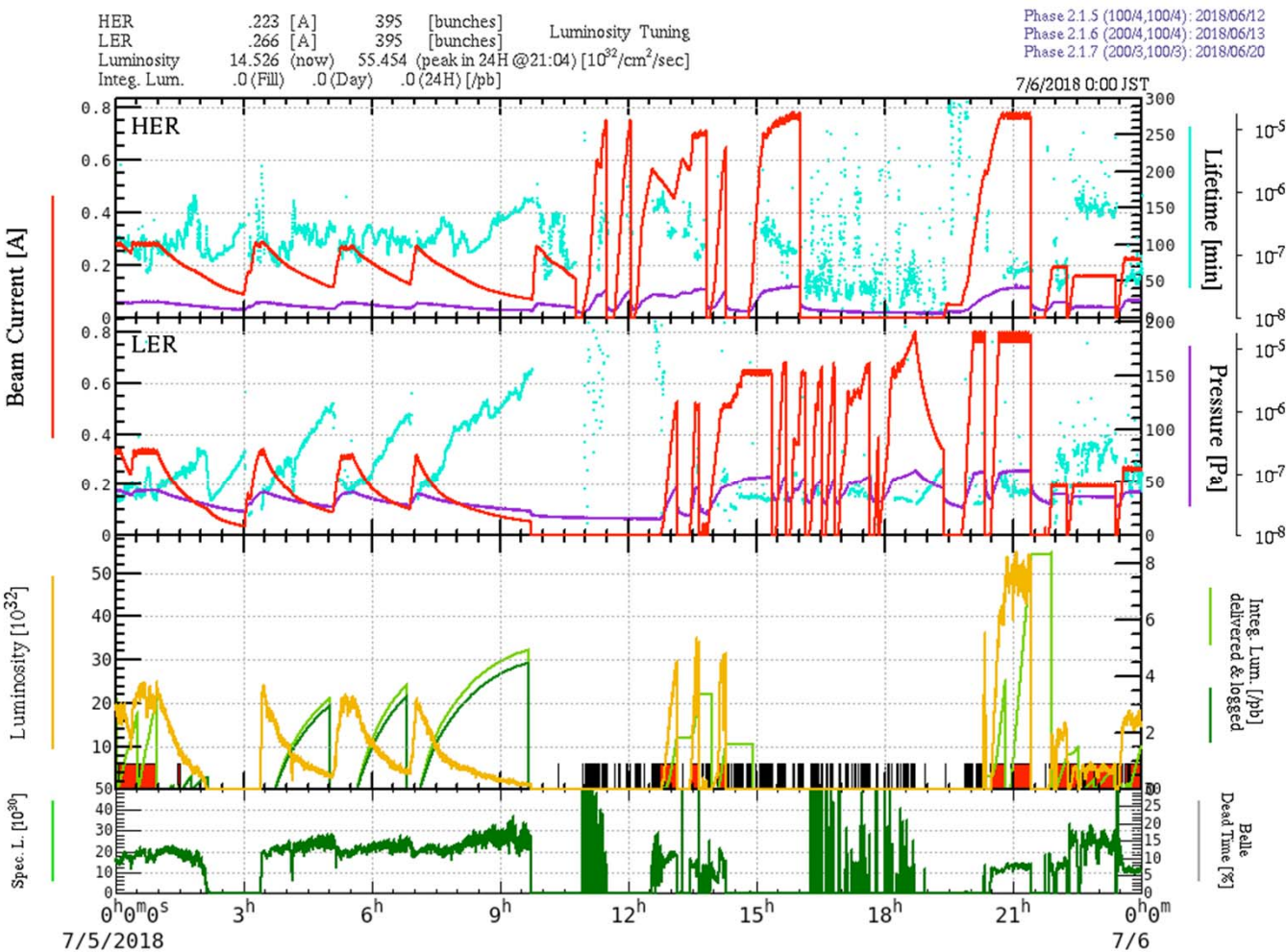

Luminosity tuning had priority. When accelerator physicists became tired, Belle II did commissioning or took data (usually owl shift only). Only able to record $\sim 0.5 \text{ fb}^{-1}$ during Phase 2 pilot run.

TOP in Phase 2

The phase 2 data demonstrates that the TOP principle is working

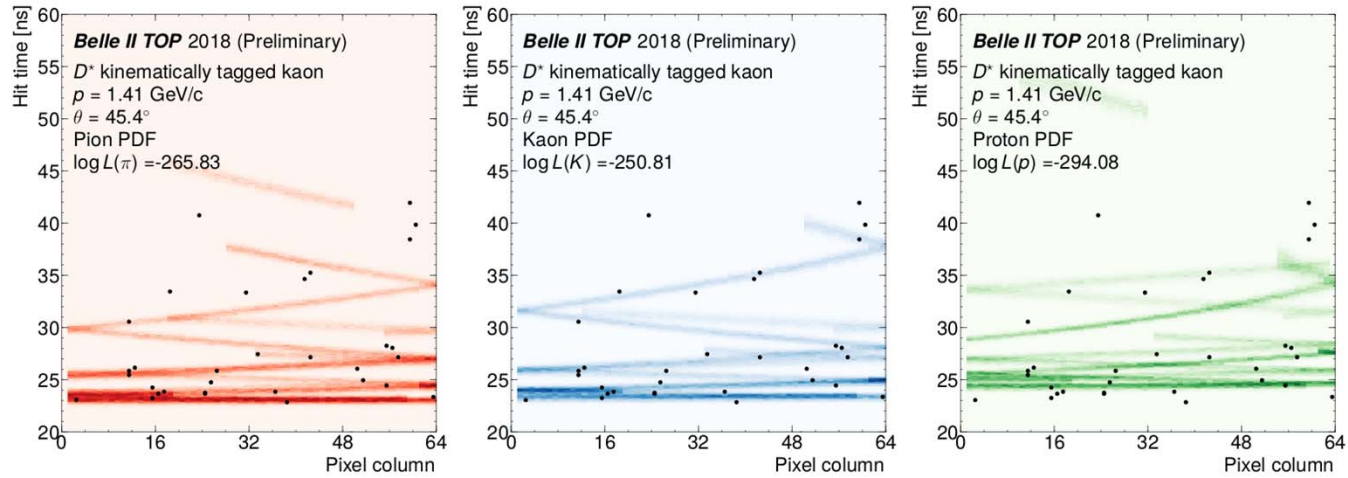

$\phi \rightarrow K^+K^-$ with both the tracks in the TOP acceptance $\phi \rightarrow KK$

$K_S \rightarrow \pi\pi$

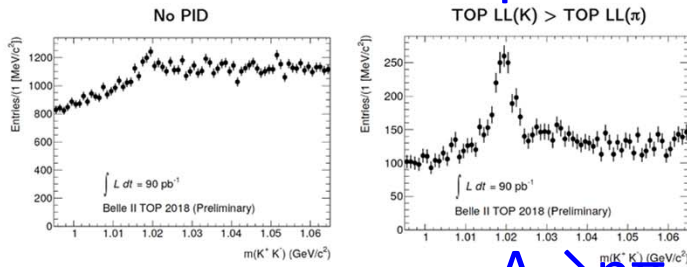

$\Lambda \rightarrow p\pi$ with the proton candidate in the TOP acceptance $\Lambda \rightarrow p\pi$

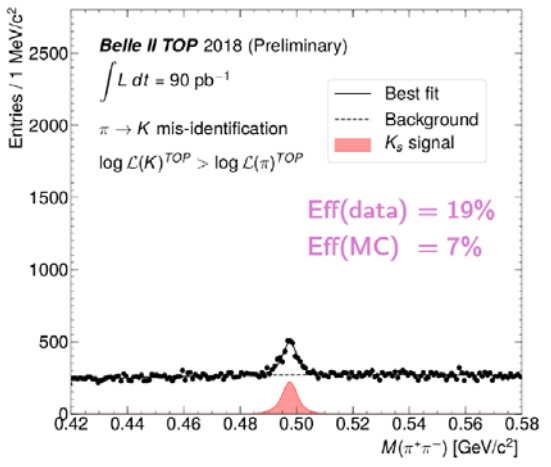
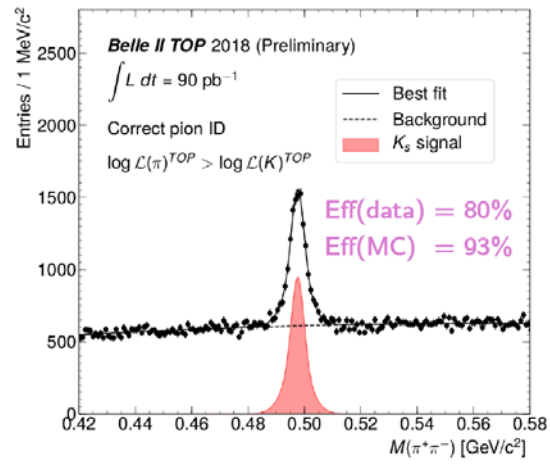
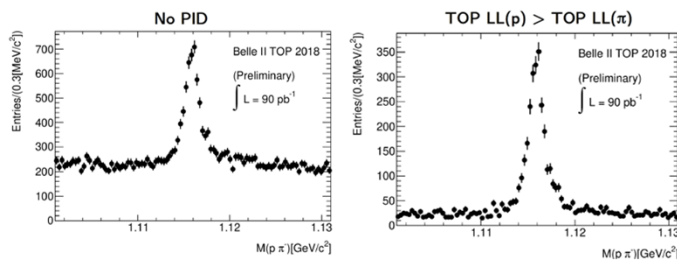

CDC: Phase 2 dE/dx performance

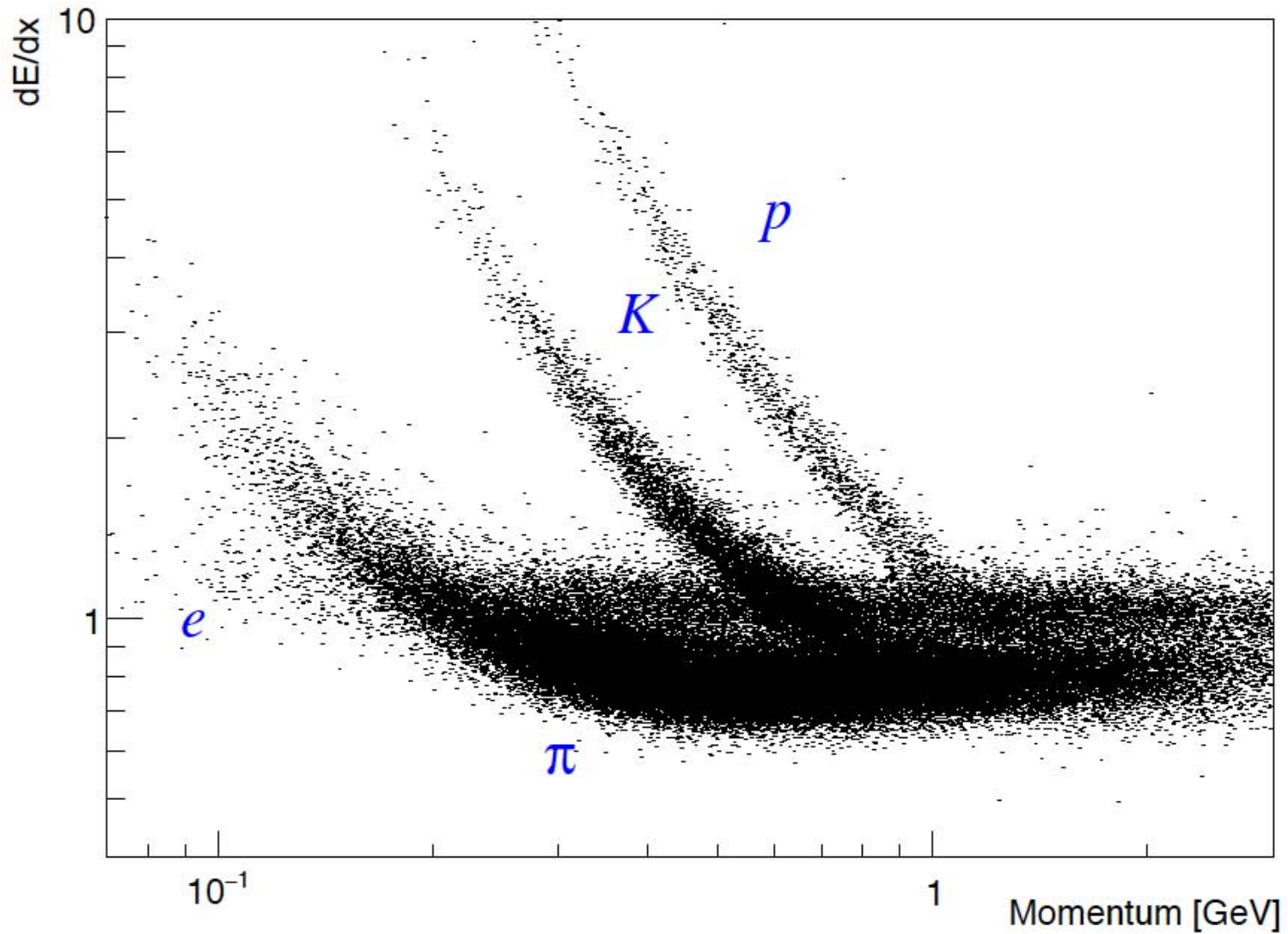

In June, we found our first peak in the beam-constrained mass distribution with ~ 88 events.

We have rediscovered the B meson !

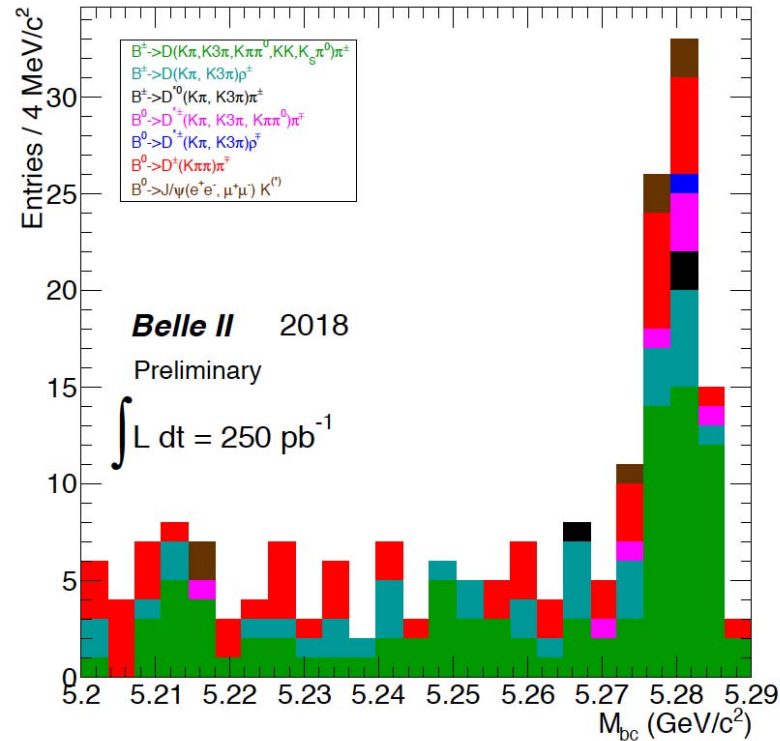

With the full Phase 2 dataset and by applying the FEI (Full Event Interpretation) technique based on boosted decision trees (BDTs, a machine learning technique), we now observe ~ 600 fully reconstructed B mesons.

The next step: getting ready for real running ("Phase 3")

Both PXD Halves assembled on Beam Pipe

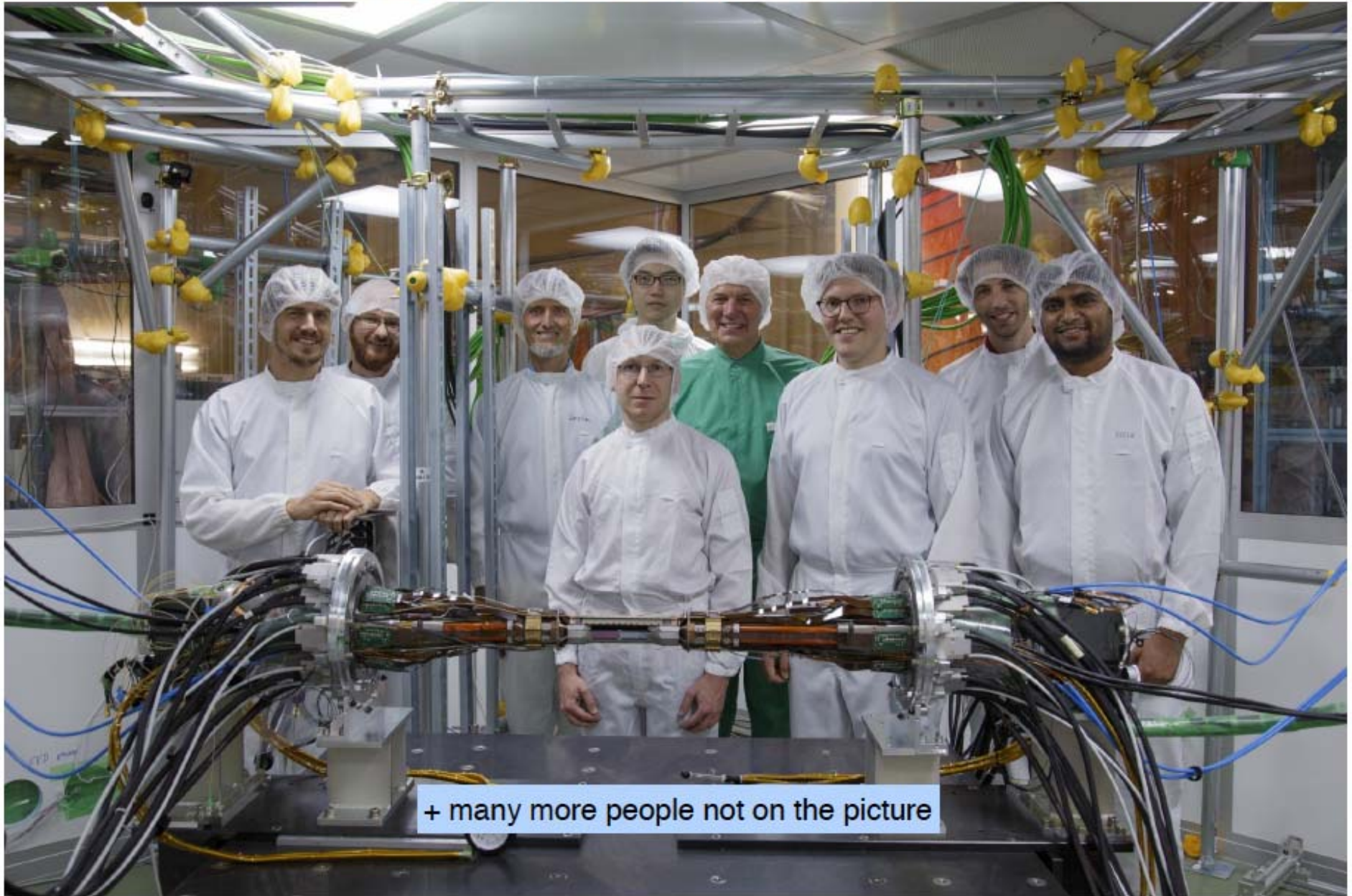

SVD construction is finally done !

SVD +X completion (Feb 2018)



SVD -X completion (Jul 2018)



+X mount on PXD (Oct 3, 2018)



And completed... (Oct 4, 2018)

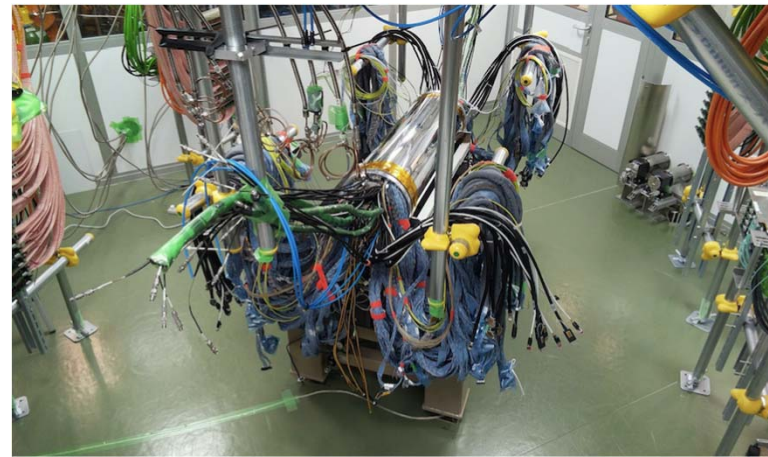

SVD standalone commissioning in B4

- The two SVD halves have operated from July to September in Tsukuba B4
- No particular issue has been encountered during this operation
- Cosmic data and special background runs were taken to understand the system prior to the start of phase 3

First cosmic event in
SVD +X (Jul 10, 2018)

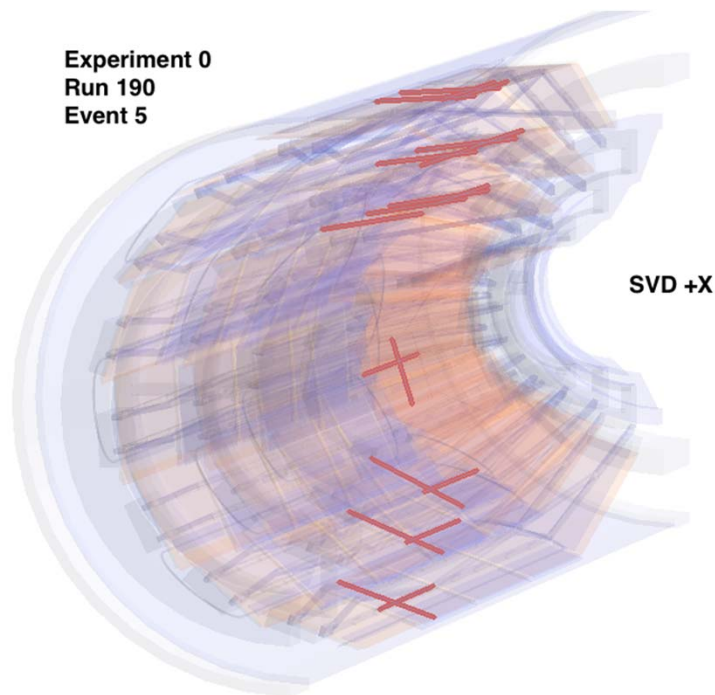

First cosmic event in
full SVD (Aug 17, 2018)

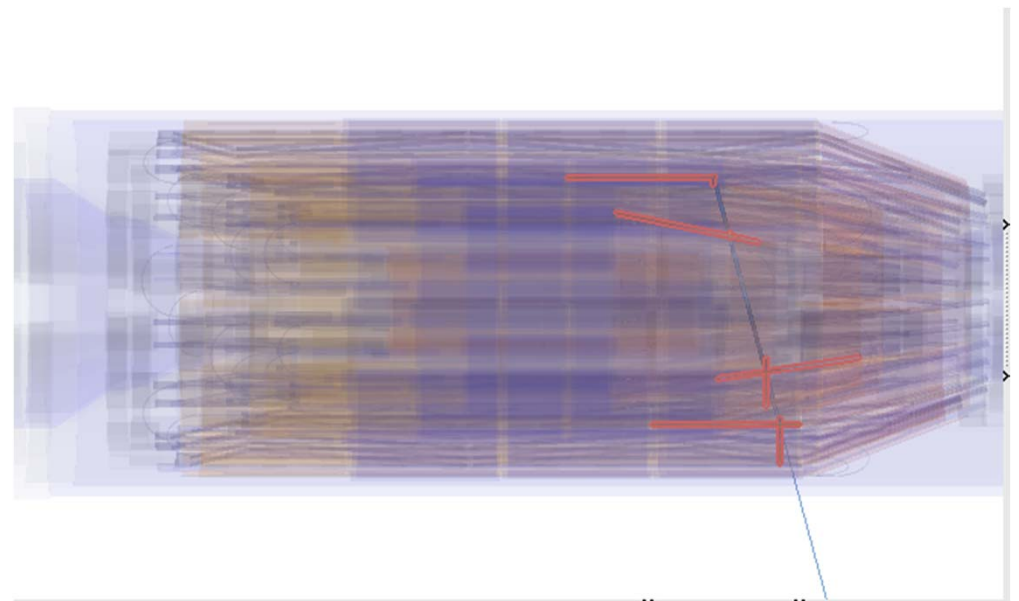

Getting ready for Phase 3: mitigation of issues found in Phase 2 running

Example: the cooling system of electronics of ARICH had to be upgraded; finite element analysis at LAL, now installed and successfully tested!

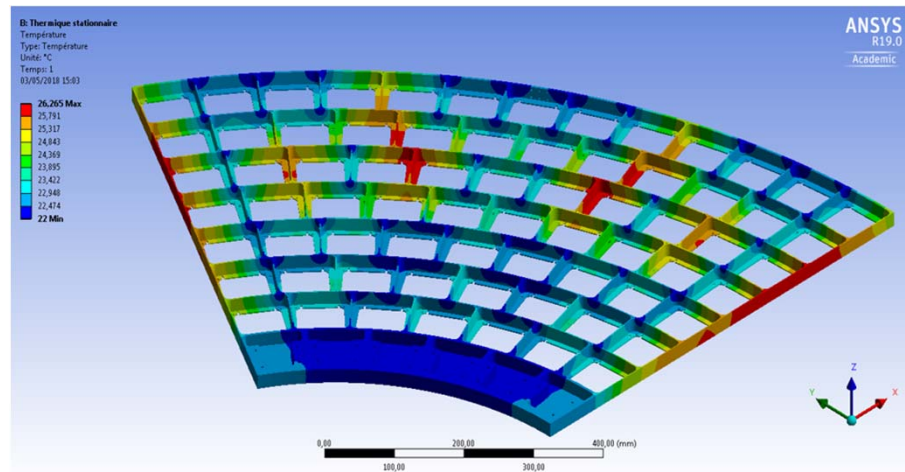

Belle II Status Summary

The Belle II detector is ready to accept the final missing piece, the full vertex detector → installation starts this week.

All systems are being debugged to improve on issues we have seen in Phase 2.

Expect beam operation from March 11, then run until end of June: initial period of Phase 3.

The baseline plan: run for 9 months/year, with a target integrated luminosity of 50/ab.

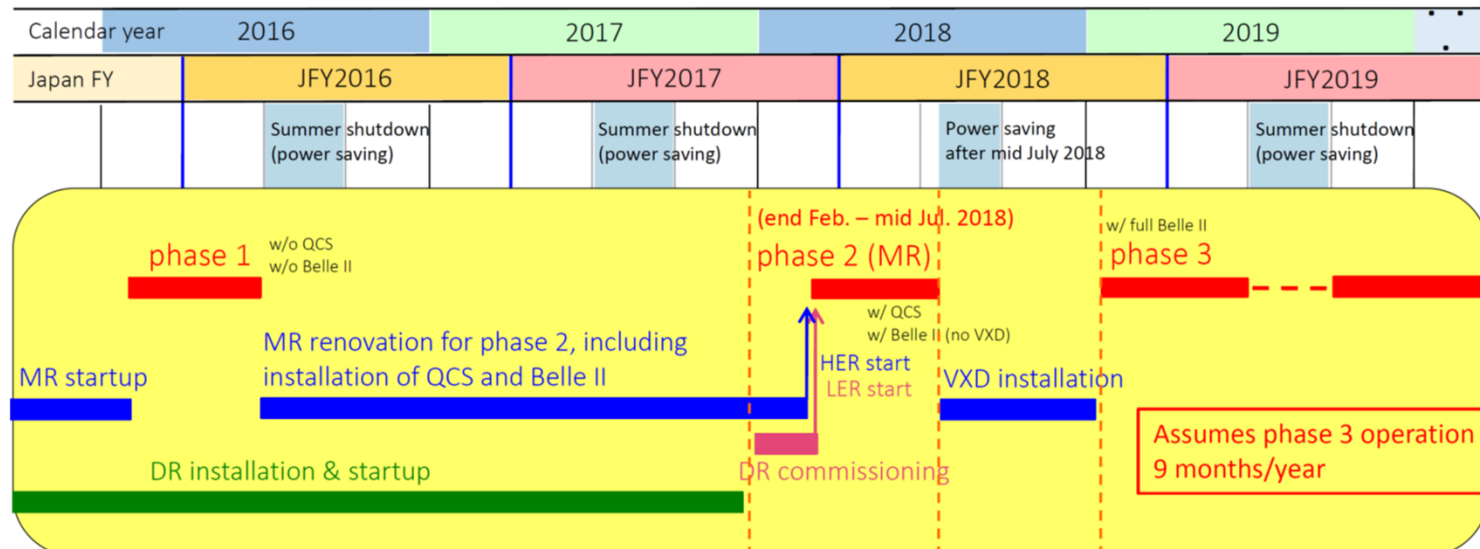

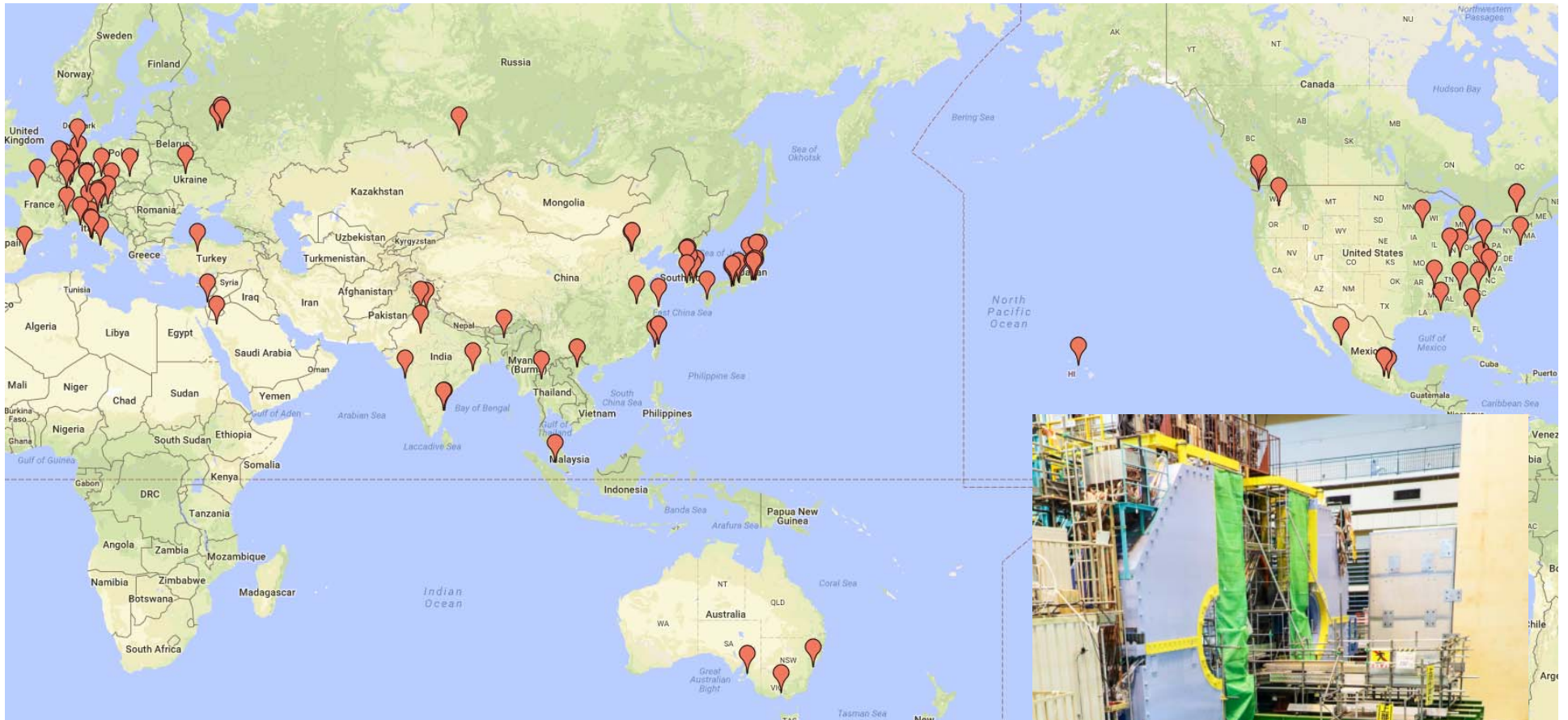

A very strong group of ~750 highly motivated scientists!

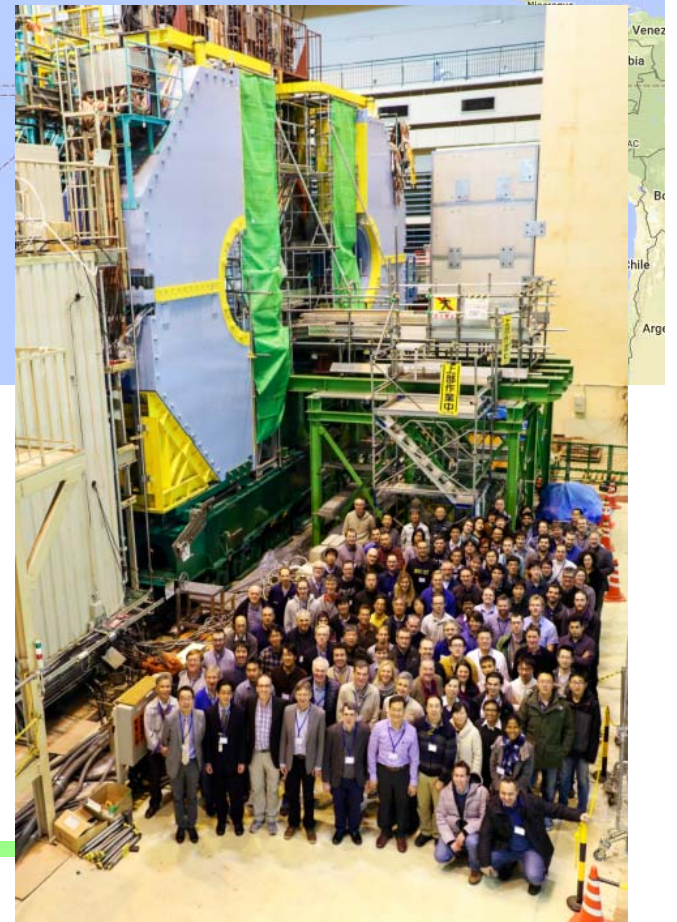

Physics prospects @ Belle II

B2TIP: Belle2 Theory Interface Platform

- A series of joint workshops with theorists
- Belle II Physics book, arXiv:1808.10567, to be published in PTEP

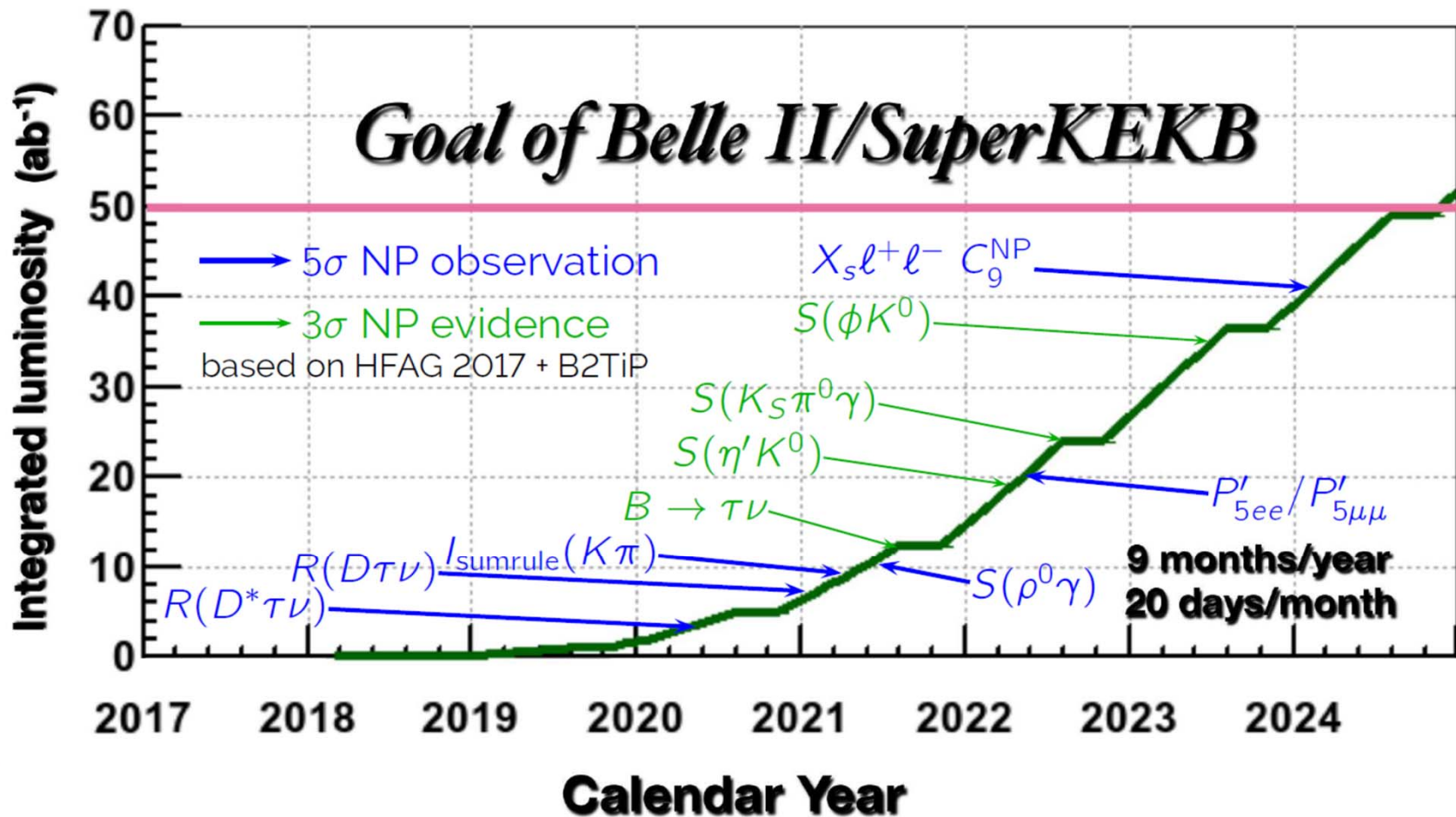

Physics prospects

Belle II strategy for New Physics searches:

- Statistics 1 ab^{-1} (Belle) \rightarrow 50 ab^{-1} (Belle II)
- Predictions of SM with small theoretical uncertainties
- Precise measurements with small systematic errors

Belle II reach - a few examples

- lepton flavor universality checks
- $B \rightarrow K_{\nu\nu}$
- CPV in $B \rightarrow K_S \pi^0 \gamma$
- CPV in $B \rightarrow K\pi$
- Dark sector studies in Phase 2

Measure TDCP asymmetry in $K_S \pi^0 \gamma$

Time dependent CP asymmetry parameters

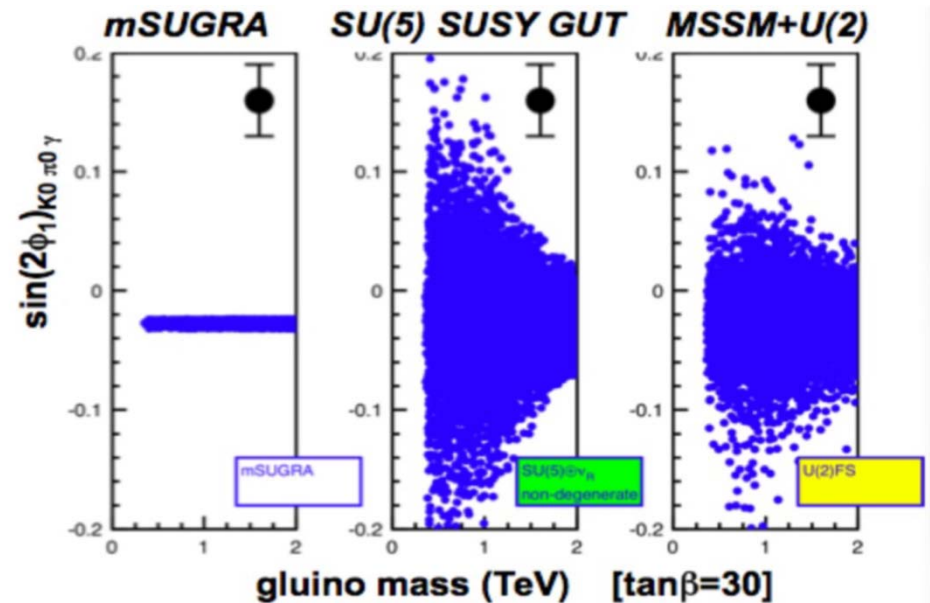
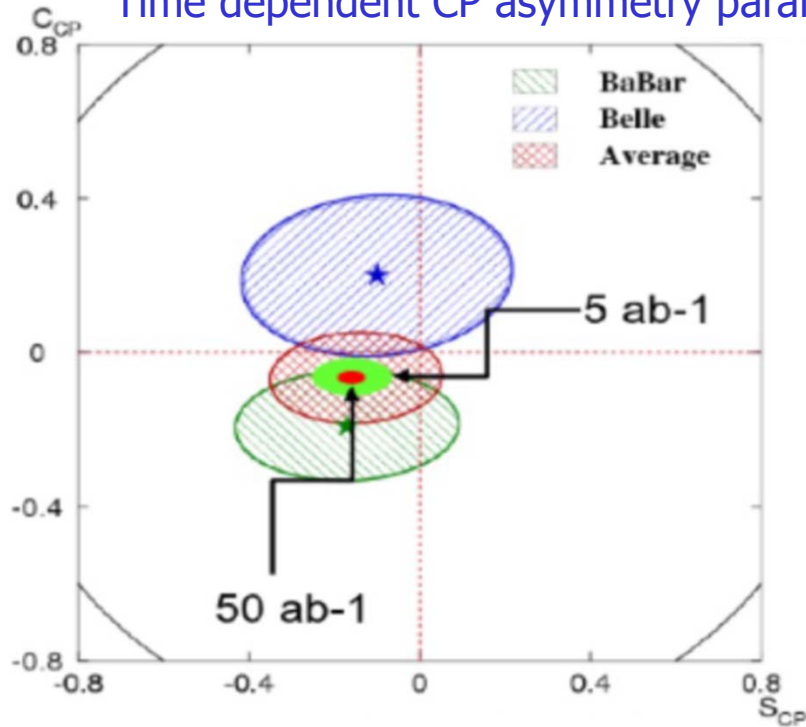

The value of S can discriminate among SUSY-breaking mechanisms

$$S = -0.16 \pm 0.22, \quad C = -0.04 \pm 0.14$$

Mostly statistic limited, expected uncertainties

$$\sigma(S) \sim 0.09 \text{ at } 5 \text{ ab}^{-1}$$

$$\sim 0.03 \text{ at } 50 \text{ ab}^{-1}$$

G. Buchalla et al., EPJC 57 (2008) 309

$K\pi$ puzzle: Need to measure all the asymmetries

□ Difference of CP asymmetry between B^0 and B^+

- ▶ Enhanced C?
- ▶ QCD?
- ▶ New Physics in P_{EW} ?

$$B^+ \rightarrow K^+\pi^0: T + P + C + P_{EW} + P_{EW}^C + A$$

$$B^0 \rightarrow K^+\pi^-: T + P + P_{EW}^C$$

Dominant Sub-dominant

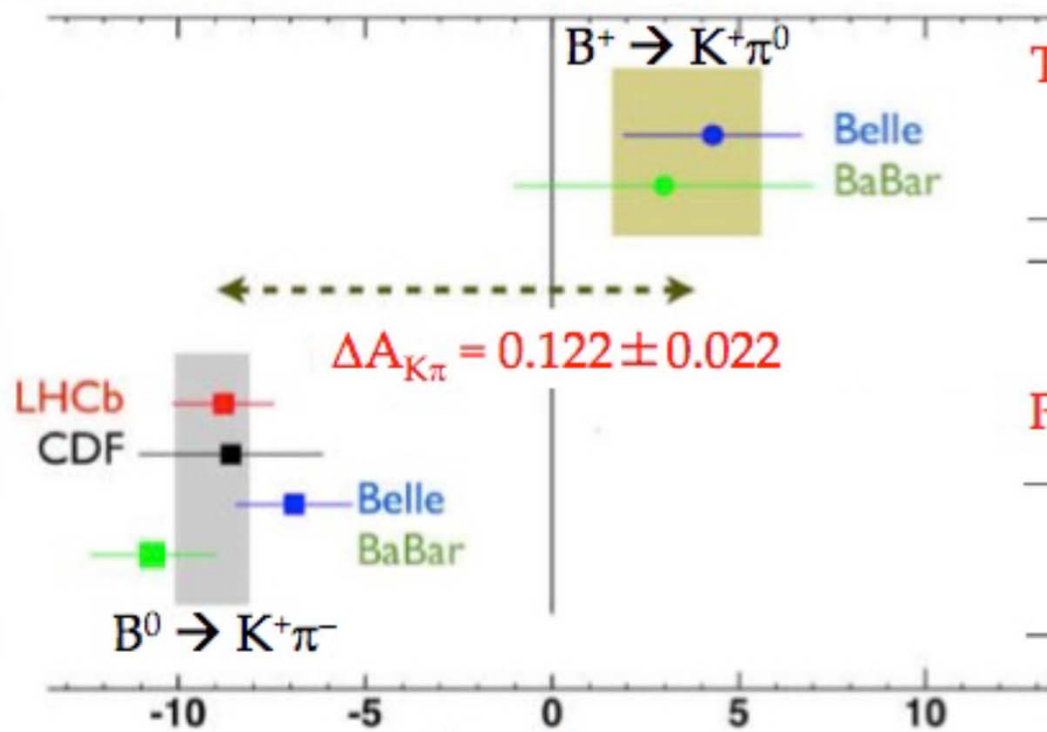

$$A_{CP}(B \rightarrow f) = \frac{\Gamma(\bar{B} \rightarrow \bar{f}) - \Gamma(B \rightarrow f)}{\Gamma(\bar{B} \rightarrow \bar{f}) + \Gamma(B \rightarrow f)} (\%)$$

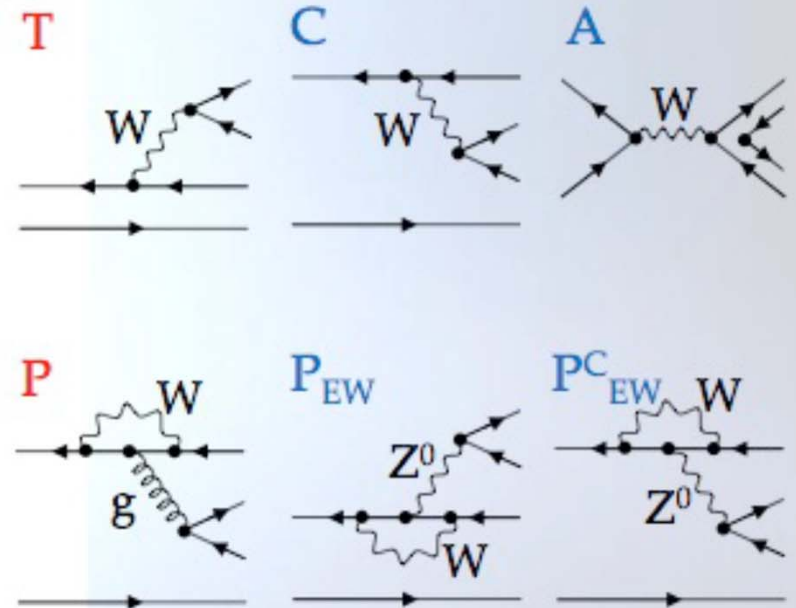

Direct CP asymmetries in neutral states

□ Sum rule of A_{CP} was proposed: [Phys. Lett. B 627 (2005) 82-88]

$$I_{K\pi} \equiv A_{CP}(K^+\pi^-) + A_{CP}(K^0\pi^+) \frac{B(K^0\pi^+) \tau_0}{B(K^+\pi^-) \tau_+} - 2A_{CP}(K^+\pi^0) \frac{B(K^+\pi^0) \tau_0}{B(K^+\pi^-) \tau_+} - 2A_{CP}(K^0\pi^0) \frac{B(K^0\pi^0)}{B(K^+\pi^-)} \approx 0$$

$I_{K\pi} \neq 0$ would be evidence for New Physics

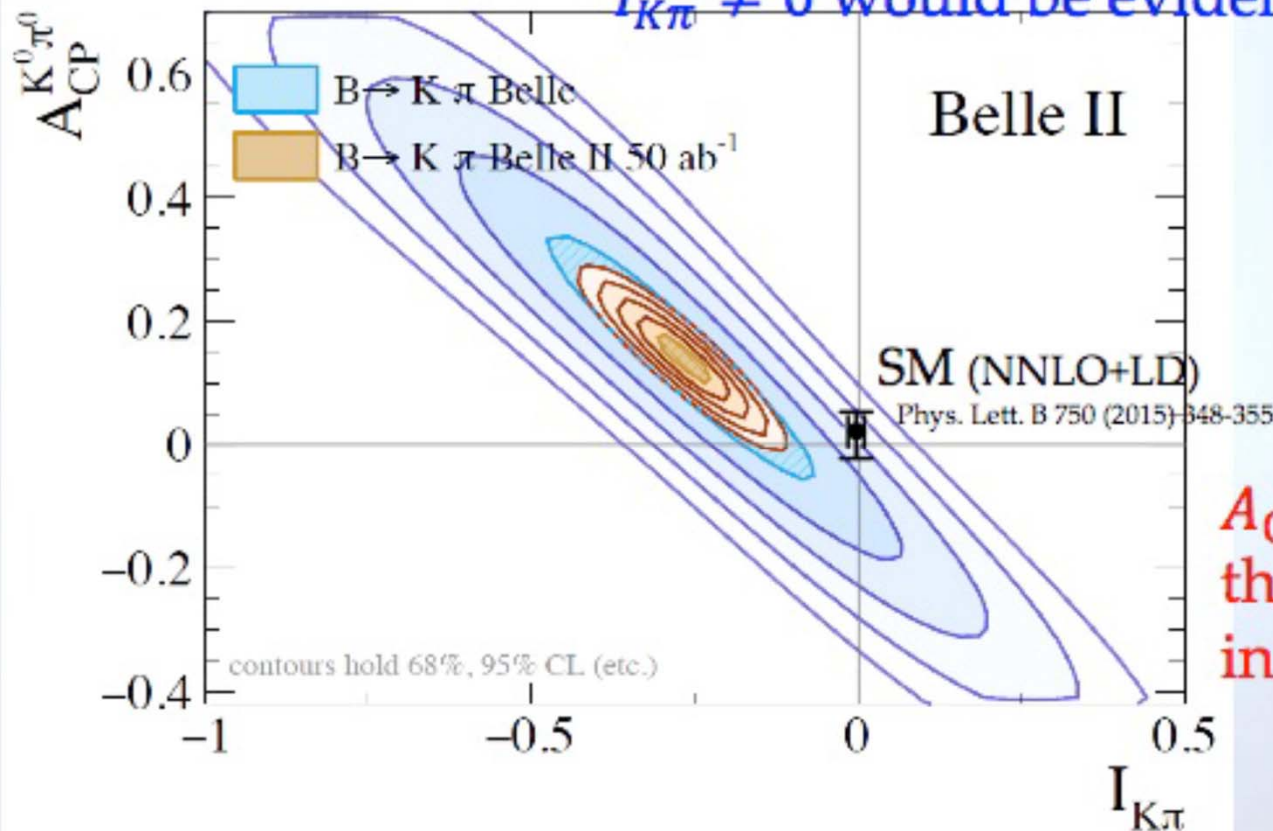

$A_{CP}(K^0\pi^0)$ is one of the key measurements in Belle II

Lepton universality in $B \rightarrow D^{(*)} \tau \nu$

$$R(D^{(*)}) = \frac{\Gamma(B \rightarrow D^{(*)} \tau \nu)}{\Gamma(B \rightarrow D^{(*)} \ell \nu)} \quad (\ell = e \text{ or } \mu)$$

- Partial cancellation of theoretical uncertainties related to hadronic effects and measurement systematics.

$$P_{\tau}(D^{*}) = \frac{\Gamma^{+} - \Gamma^{-}}{\Gamma^{+} + \Gamma^{-}} \quad (\Gamma^{\pm}: \text{decay rate of } \pm \tau\text{-helicity})$$

- Another probe of New Physics

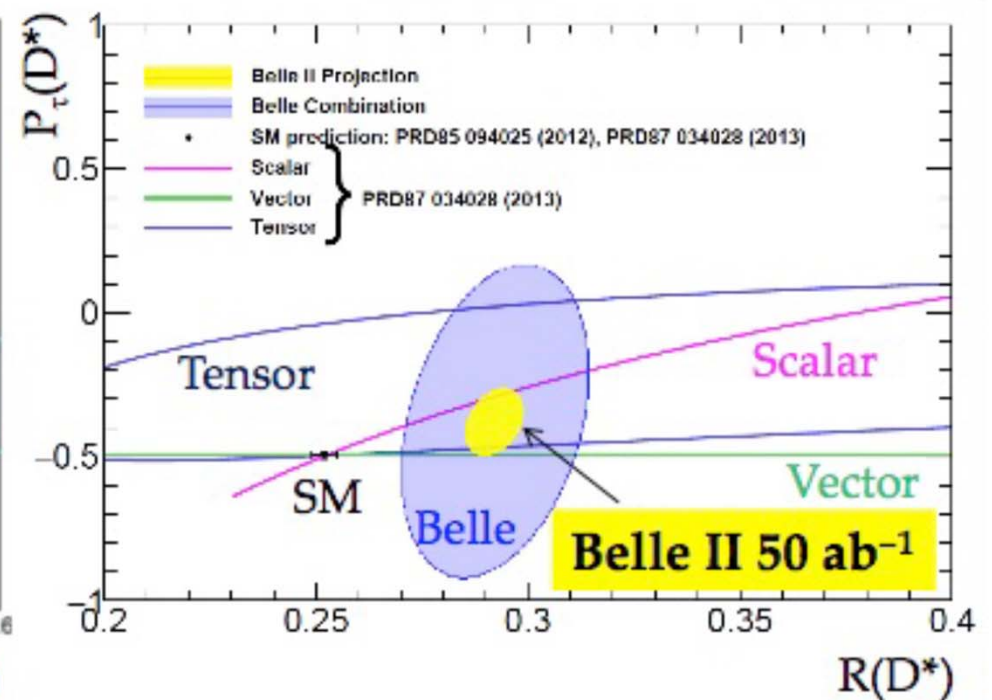
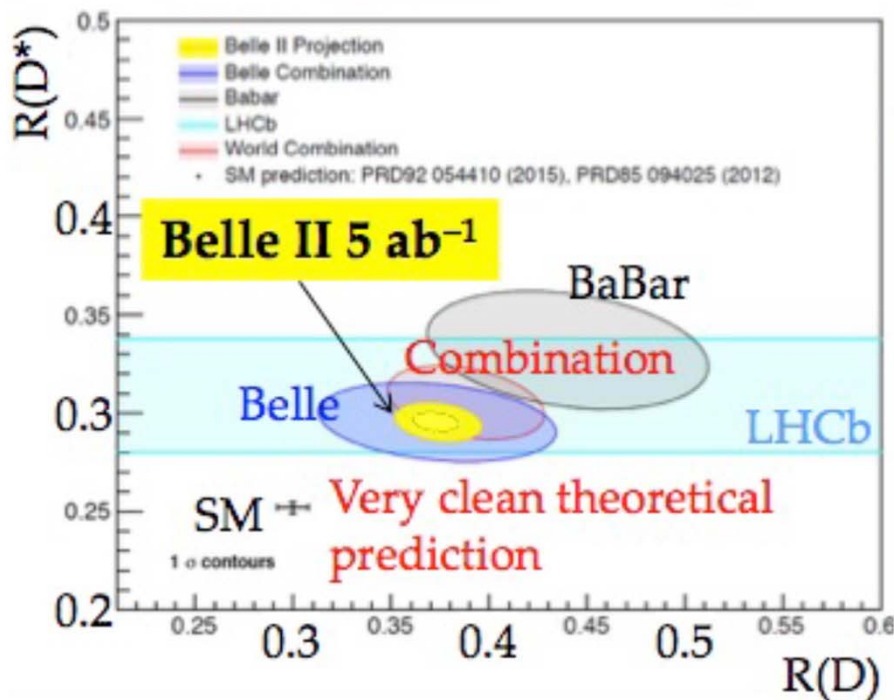
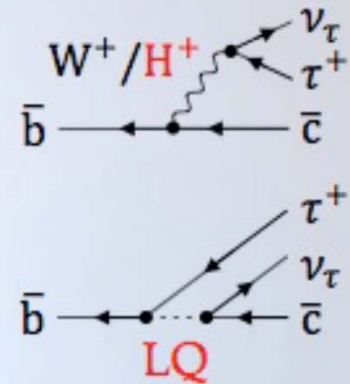

$$B^- \rightarrow \tau^- \nu_\tau$$

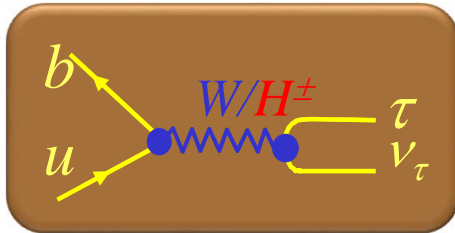

$$B^+ \rightarrow D^0 \pi^+$$

$$(\rightarrow K \pi^- \pi^+ \pi^-)$$

$$B^- \rightarrow \tau (\rightarrow e \nu \bar{\nu}) \nu$$

Example of a challenging rare decay

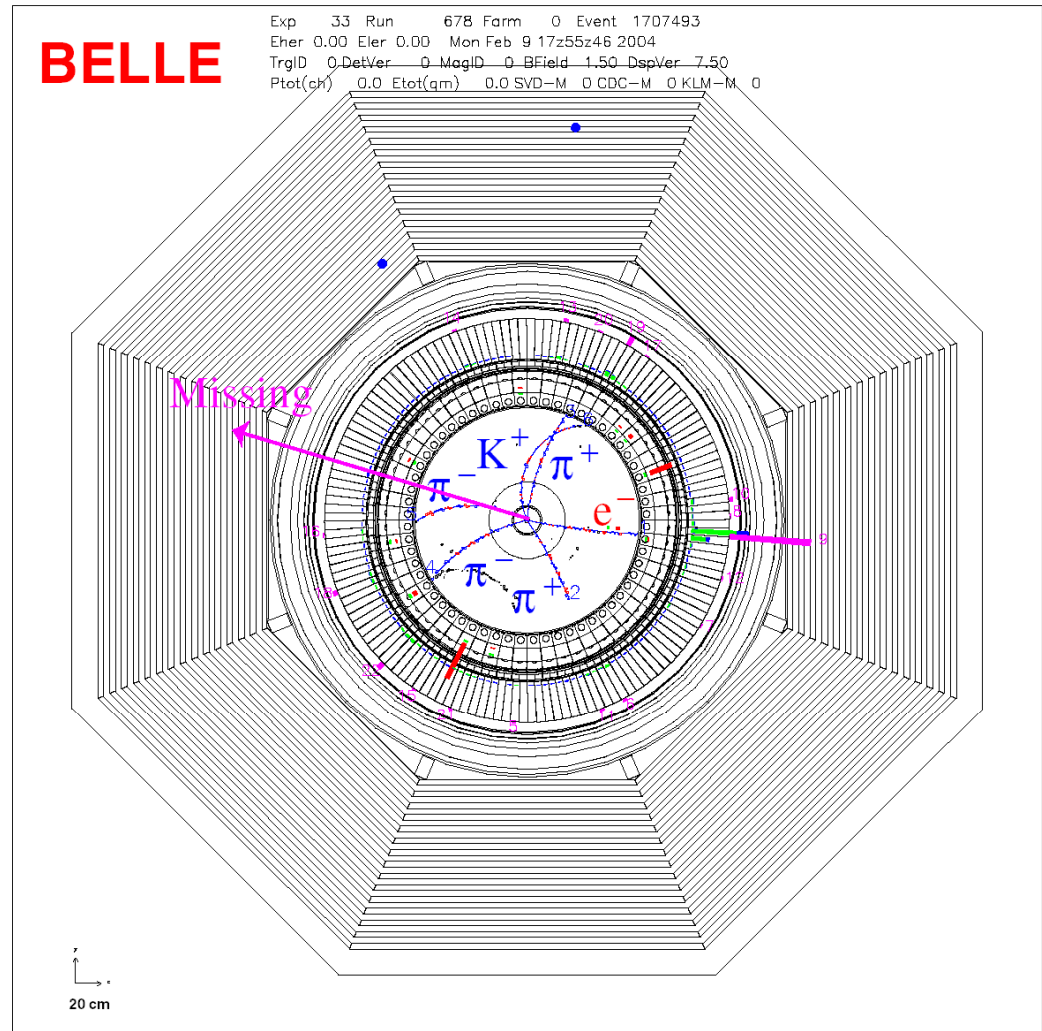

Full reconstruction tagging

Idea: **fully (or partially) reconstruct** one of the B's to tag B flavor/charge, determine its momentum, and exclude decay products of this B from further analysis
(exactly two B's produced in $\Upsilon(4S)$ decays)

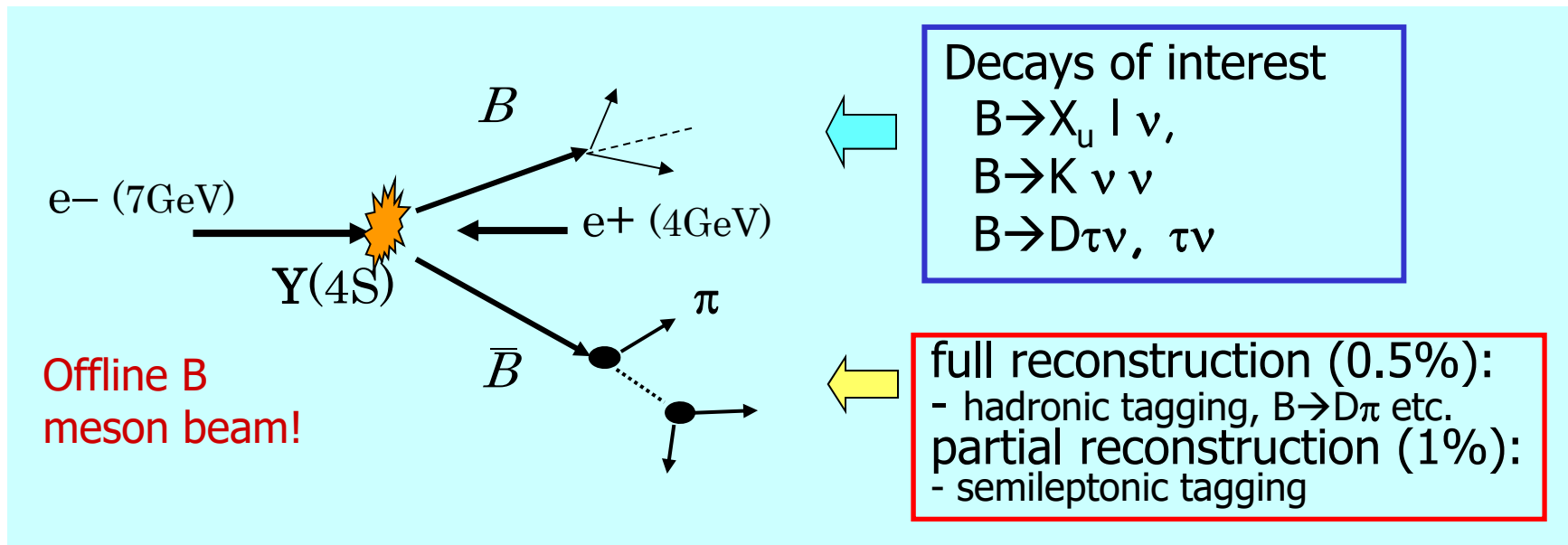

Powerful tool for B decays with neutrinos

→ unique feature at B factories

Example for the impact of $B \rightarrow \tau^- \nu_\tau$: charged Higgs limits

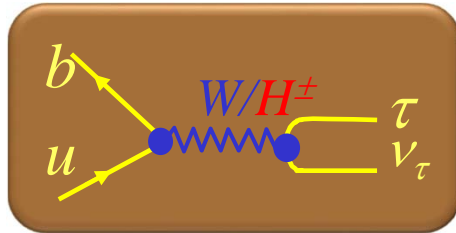

$$r_H = \frac{BF(B \rightarrow \tau \nu)}{BF(B \rightarrow \tau \nu)_{SM}} = \left(1 - \frac{m_B^2}{m_H^2} \tan^2 \beta \right)^2$$

Measured value

can be – for example - turned into a limit on charged Higgs parameters (in case of the type II 2HDM)

B factories: Exclusion plot

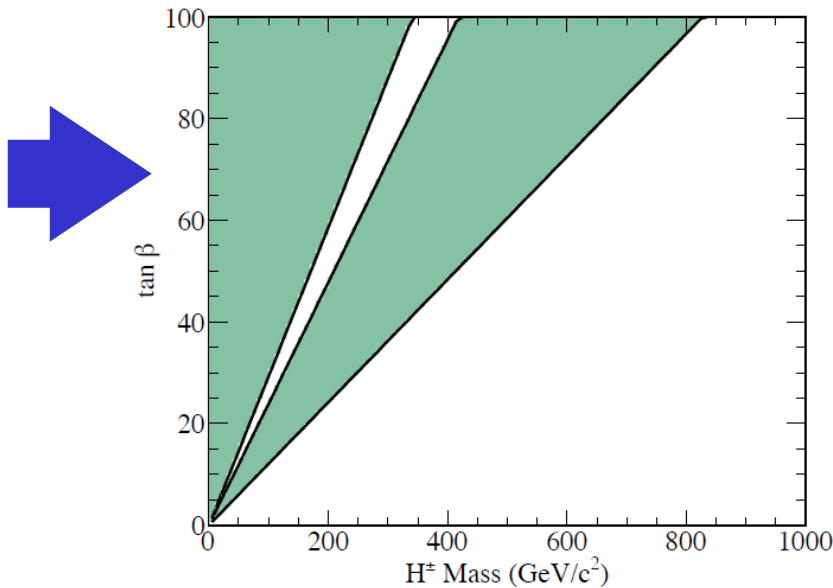

Belle II: in excellent competition with LHC!

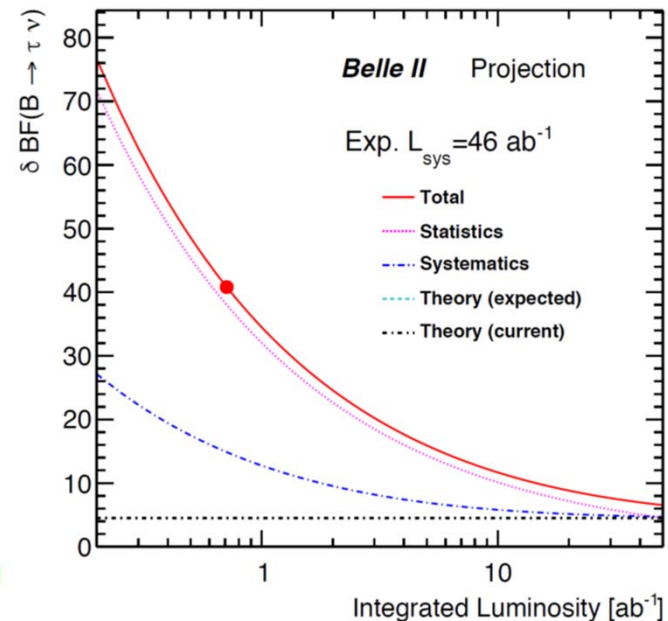

$$B \rightarrow K^{(*)} \nu \bar{\nu}$$

SM: penguin + box diagrams

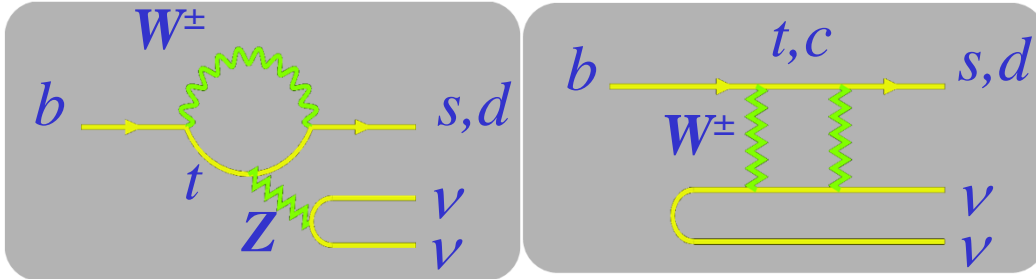

Look for deviations from the expected values \rightarrow information on anomalous couplings

$$C_R^{\nu} \text{ and } C_L^{\nu}$$

$$B \rightarrow K \nu \nu, \mathcal{B} \sim 4 \cdot 10^{-6}$$

$$B \rightarrow K^* \nu \nu, \mathcal{B} \sim 6.8 \cdot 10^{-6}$$

compared to the SM value $(C_L^{\nu})^{\text{SM}}$, coming from, e.g., processes like

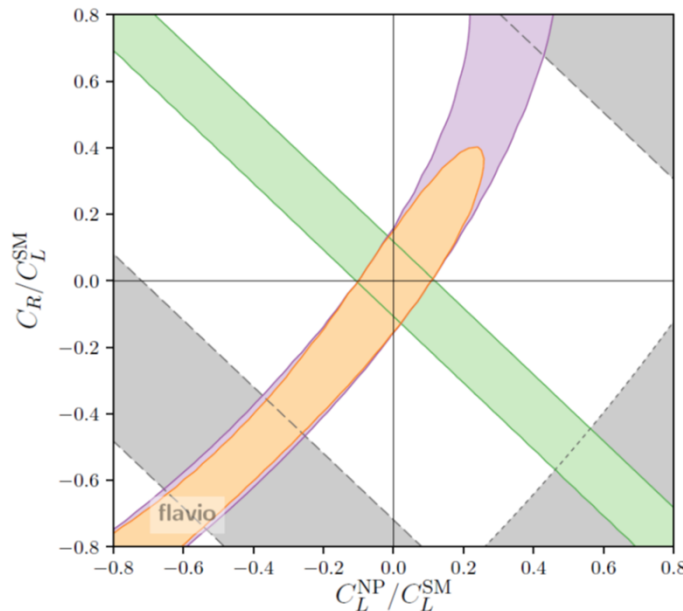
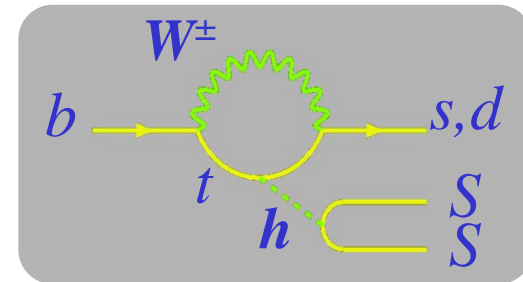

Dark sector

Possible to provide competitive results even with the limited statistics of the initial three months of Phase 3 running (by end of June 2019).

- New triggers will be used in Belle II to search for dark matter and dark photons.
- ▶ Single photon trigger with ~ 1 GeV threshold to search for dark photon decaying into light dark matter

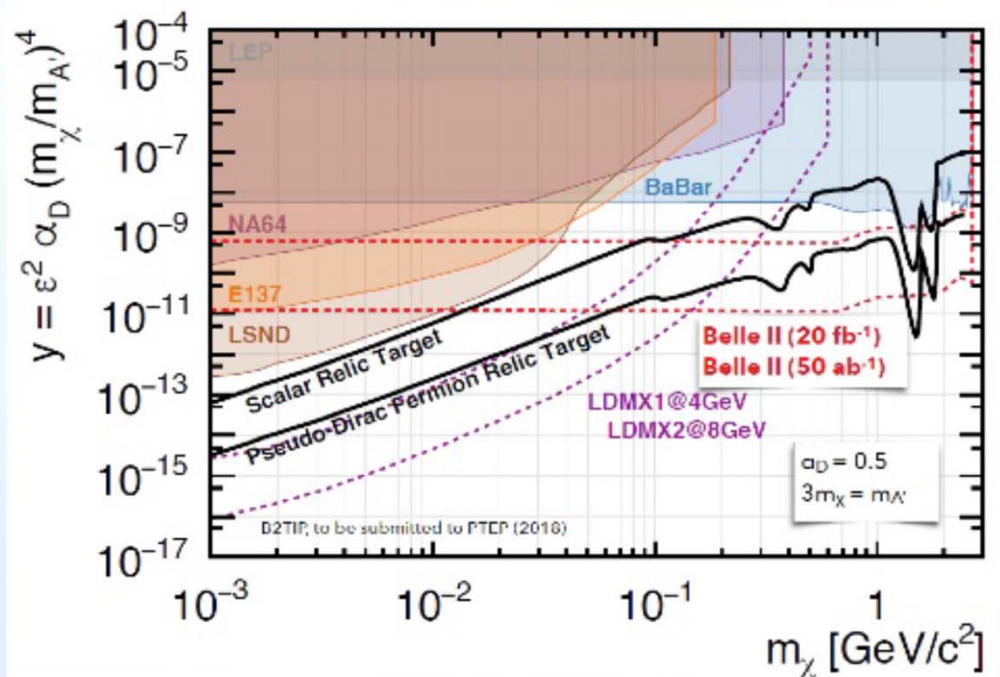
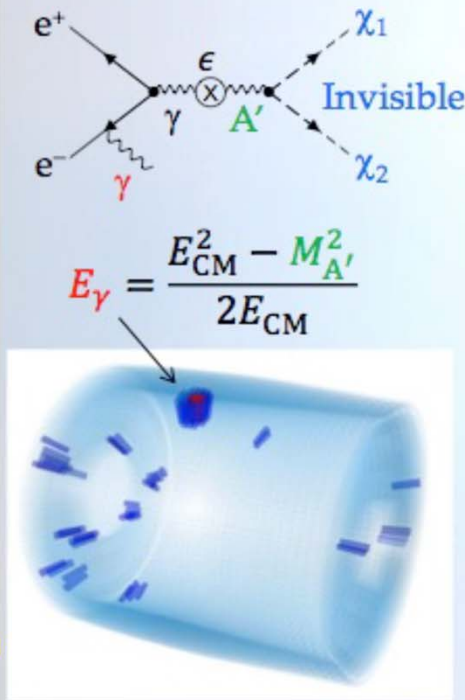

Summary

- Physics of B mesons has contributed substantially to our present understanding of elementary particles and their interactions
- B factories have proven to be an excellent tool for flavour physics as well for searches for new hadronic states, with **reliable long term** operation, constant **improvement** of the performance, **achieving and surpassing** design performance
- Super B factory at KEK, SuperKEKB+Belle II with **L x40**, in the **final preparation phase**
- In the time when LHCb is exploring anomalies in B decays, a new player is getting ready
- Expect a new, exciting era of discoveries, and a friendly competition and complementarity of Belle II, LHCb and BESIII
- We are very happy to have also French teams on board!