

Isabelle RIPP-BAUDOT - IPHC Strasbourg

Physics Summer School: Physique des deux infinis

2-22 July 2017

France

Excellence

ÉCC

# Introduction to flavour physics

É

优秀硕士

法国

暑期学校

# Course outline

- ❖ Introduction to the standard model
- ❖ The CKM formalism
- ❖ Beyond the SM
- ❖ Effective Lagrangian of physics beyond the standard model

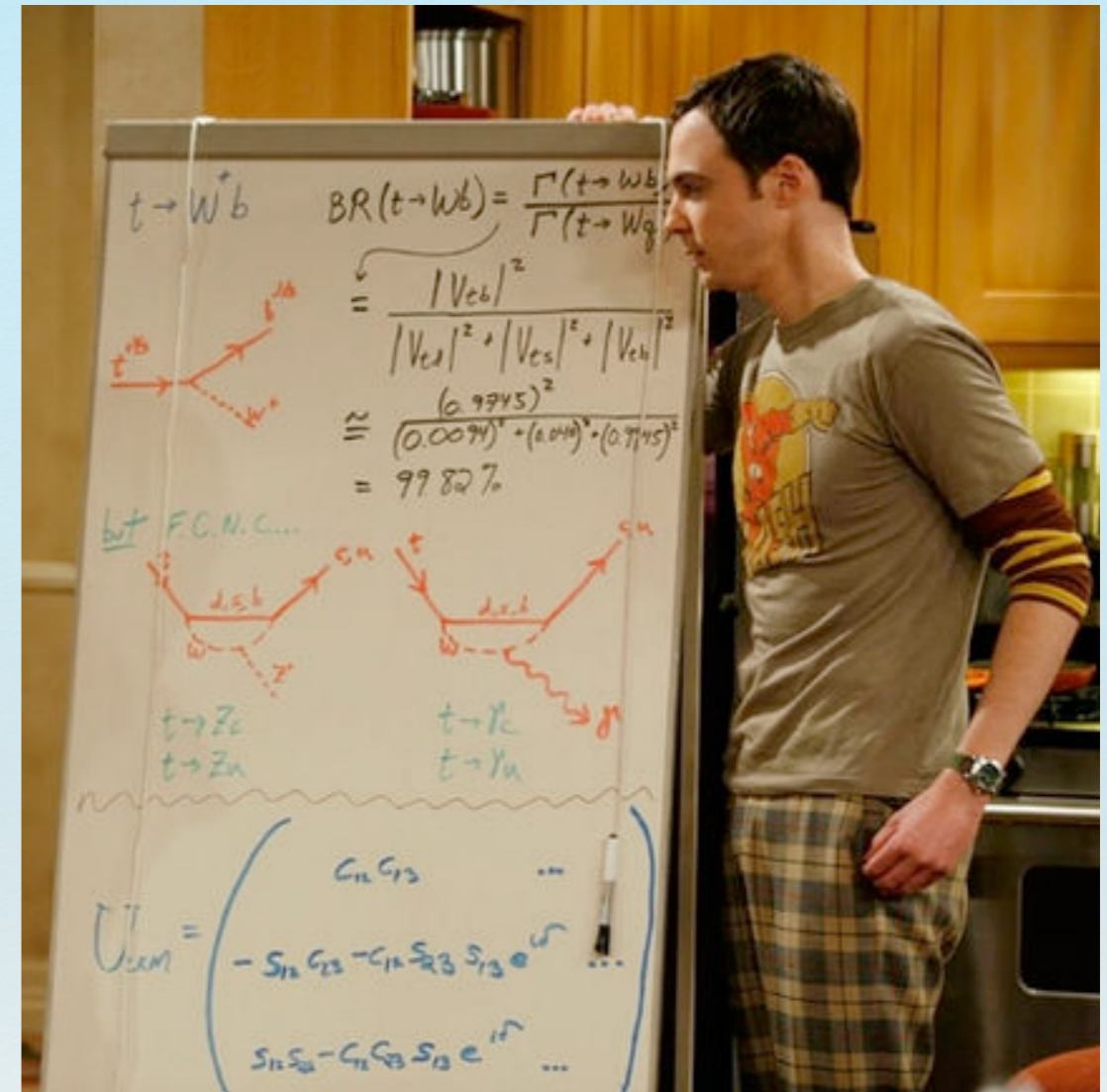

# Course outline

- ❖ Introduction to the standard model
- ❖ The CKM formalism
- ❖ Beyond the SM
- ❖ Effective Lagrangian of physics beyond the standard model

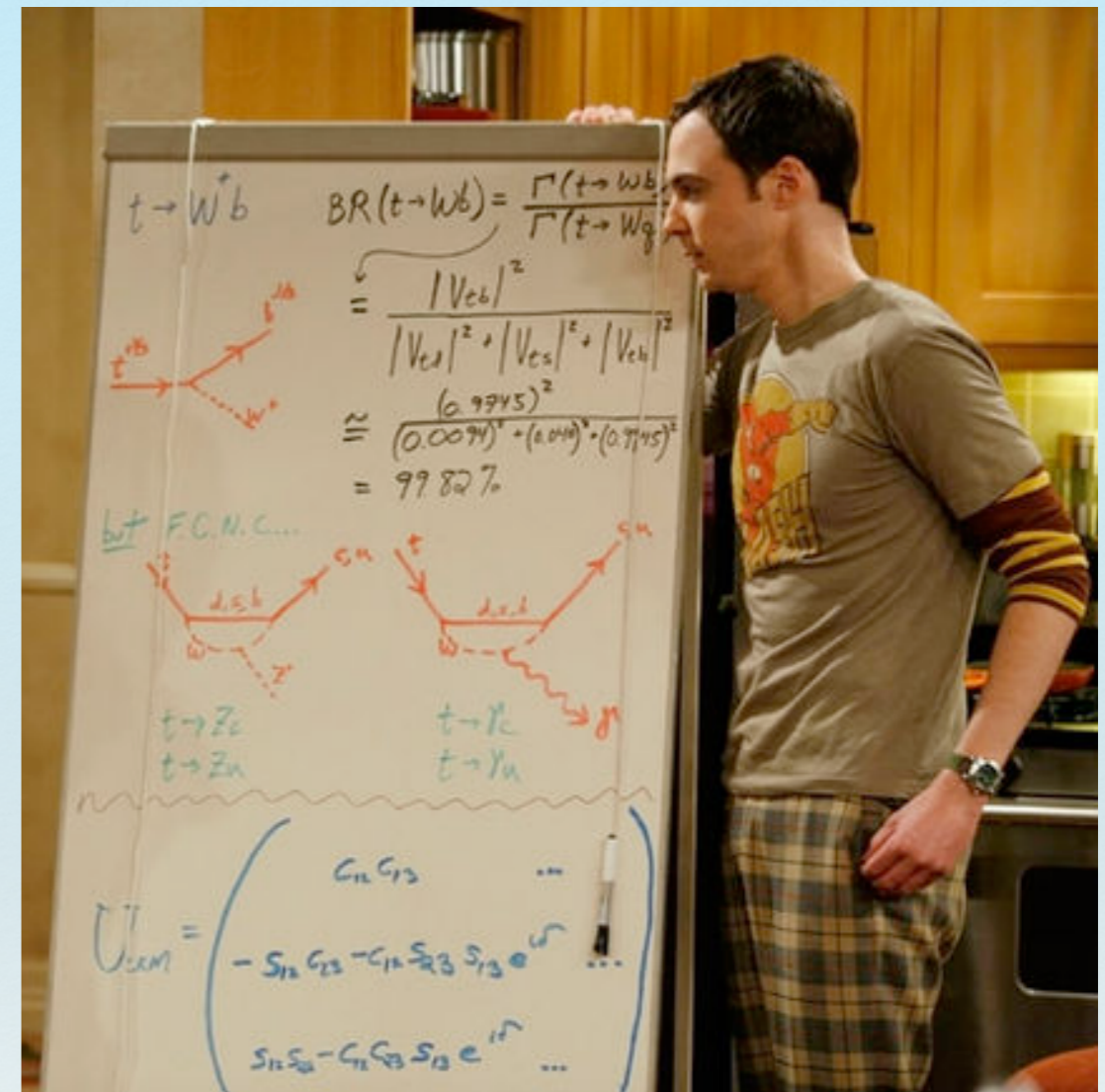

# Elementary particles and interactions

- ❖ **Elementary** : depends on experimental means. Along the time: atoms, nuclei, quarks, ... ?
- ❖ Elementary particles presently observed :
  - ❖ **Matter particles** : 12 **fermions** (6 quarks, 6 leptons) and 12 **anti-fermions**, classified in 3 **families**. Atoms made out of first family of fermions.
  - ❖ Fundamental **interaction particles** (gauge particles) : 12 **vector bosons**.
  - ❖ Mass of elementary particles : generated though their interaction with a **scalar boson, the Higgs boson**.
- ❖ Questions :
  - ❖ Are these particles actually elementary or composite?
  - ❖ Do other elementary particles exist? cf. Graviton, additional Higgs, supersymmetric particles, ...
  - ❖ Is their description correct? cf. Dirac vs. Majorana neutrino, ...

	1 <sup>ÈRE</sup> GÉNÉRATION	2 <sup>ÈME</sup> GÉNÉRATION	3 <sup>ÈME</sup> GÉNÉRATION		
masse →	≈2.3 MeV/c <sup>2</sup>	≈1.275 GeV/c <sup>2</sup>	≈173.07 GeV/c <sup>2</sup>	0	≈126 GeV/c <sup>2</sup>
charge →	2/3	2/3	2/3	0	0
spin →	1/2	1/2	1/2	1	0
	<b>u</b> up	<b>c</b> charm	<b>t</b> top	<b>g</b> gluon	<b>H</b> boson de Higgs
<b>QUARKS</b>					
	≈4.8 MeV/c <sup>2</sup>	≈95 MeV/c <sup>2</sup>	≈4.18 GeV/c <sup>2</sup>	0	
	-1/3	-1/3	-1/3	0	
	1/2	1/2	1/2	1	
	<b>d</b> down	<b>s</b> strange	<b>b</b> bottom	<b>γ</b> photon	
	0.511 MeV/c <sup>2</sup>	105.7 MeV/c <sup>2</sup>	1.777 GeV/c <sup>2</sup>	91.2 GeV/c <sup>2</sup>	
	-1	-1	-1	0	
	1/2	1/2	1/2	1	
	<b>e</b> électron	<b>μ</b> muon	<b>τ</b> tau	<b>Z</b> boson Z	
<b>LEPTONS</b>					
	<2.2 eV/c <sup>2</sup>	<0.17 MeV/c <sup>2</sup>	<15.5 MeV/c <sup>2</sup>	80.4 GeV/c <sup>2</sup>	
	0	0	0	±1	
	1/2	1/2	1/2	1	
	<b>ν<sub>e</sub></b> neutrino électronique	<b>ν<sub>μ</sub></b> neutrino muonique	<b>ν<sub>τ</sub></b> neutrino tauique	<b>W<sup>±</sup></b> bosons W <sup>±</sup>	
					<b>BOSONS DE JAUGE</b>

# Content of the universe in its first micro-second

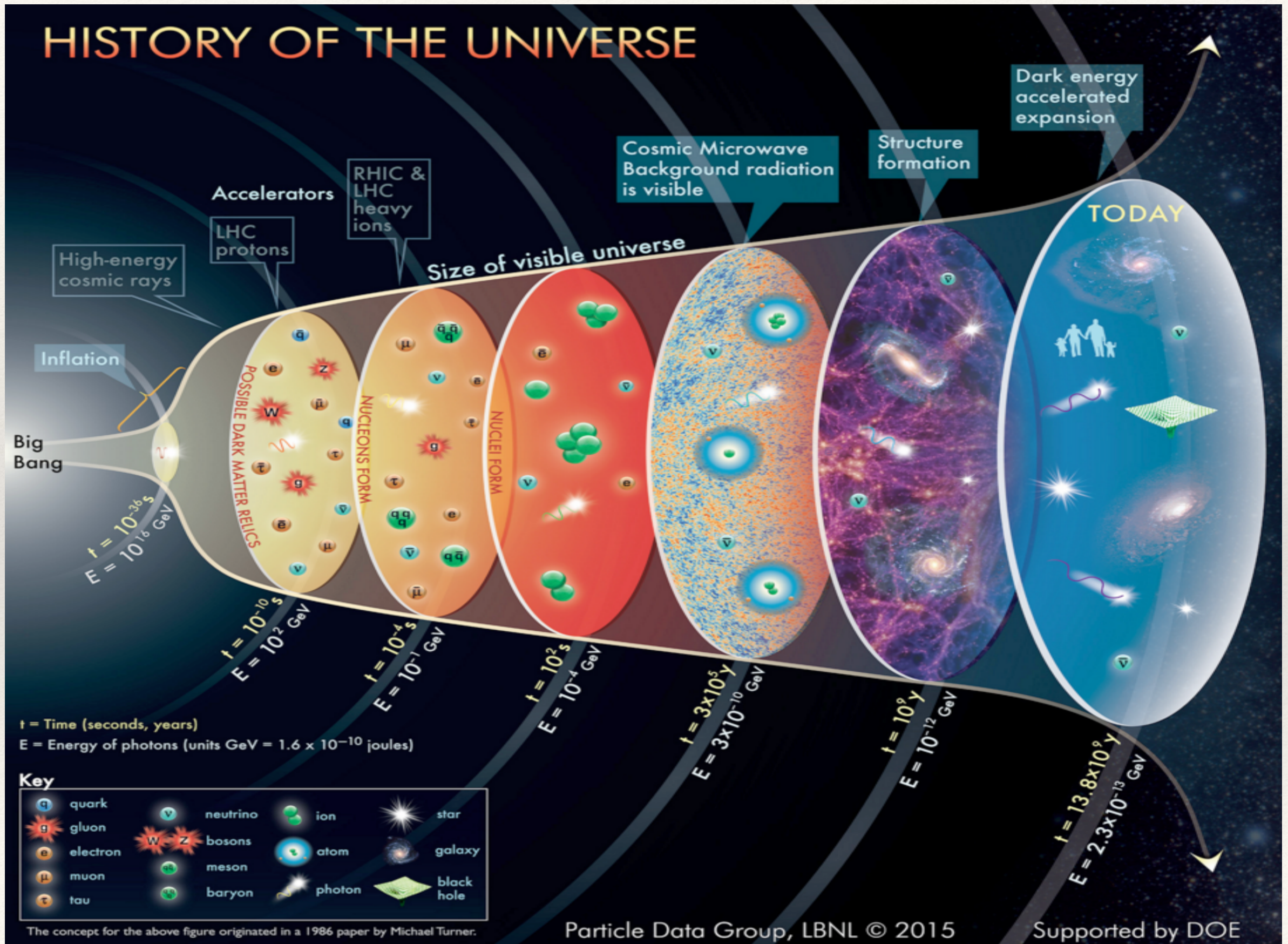

# Fermi weak interaction theory

- ❖ **Fermi theory of  $\beta$  decay:** proposed by E. Fermi in 1933.  
 $n \rightarrow p e^- \bar{\nu}$  described as the **direct coupling** between a neutron, a proton, an electron and a neutrino (later known to be an anti-neutrino).

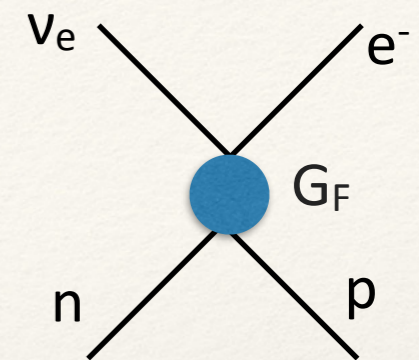

- ❖ **Important notion of effective theory:**  
 the Fermi theory of weak interaction is a low energy effective theory of the standard model. At higher energies, one is able to observe that  $\rightarrow$

With the Fermi coupling constant:

$$G_F = \frac{\sqrt{2}}{8} \frac{g^2}{m_W^2}$$

where  $g$  is the coupling of the charged weak interaction and  $m_W$  the mass of the  $W$  boson mediating this interaction.

Another example of an effective theory:

classical mechanics is a valid effective theory if velocity  $\ll c$ , and if size  $\gg$  wave length.

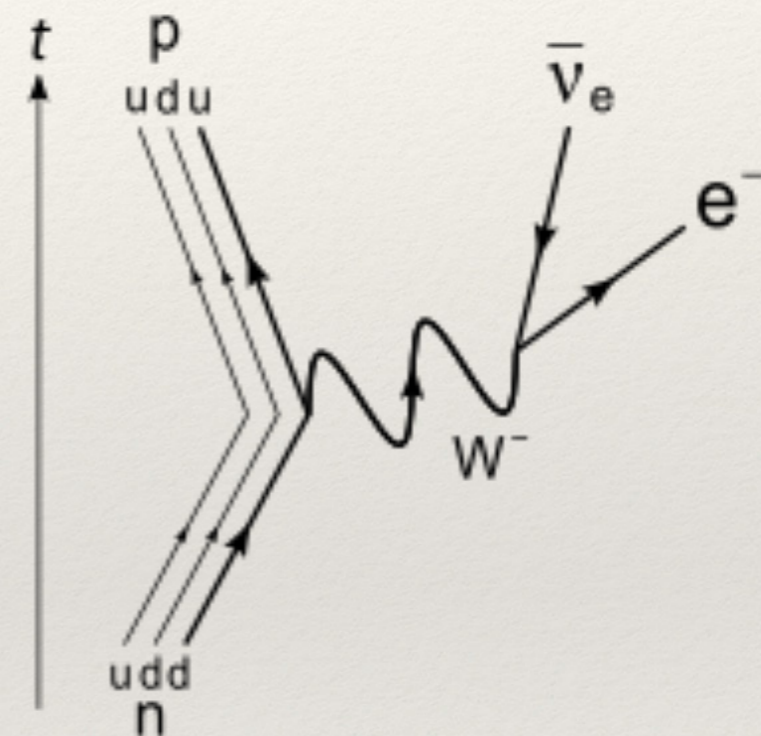

# The standard model

- ❖ Objects with very small dimensions  $\sim 10^{-18}$  m and very high energies  $\sim$ GeV-TeV: mathematical description = you put together **quantum mechanics and special relativity** (quantum field theory), you make it **renormalizable**, and you obtain the standard model of particle physics.
- ❖ Theory built on symmetry principles: **gauge symmetries**.
  - ➔ vector bosons mediating electromagnetic, weak and strong interactions, appear spontaneously in the theory once corresponding gauge local symmetries are required.
- ❖ Ad hoc ingredients are moreover added in the mathematical description, induced by **experimental observations**:
  - ❖ charged weak interaction couples only to left chiral fermions,
  - ❖ non massive neutrinos (as it was observed in the past),
  - ❖ Higgs potential,
  - ❖ **quark mixing** through charged weak interaction,
  - ❖ 3 fermion families,
  - ❖ ...

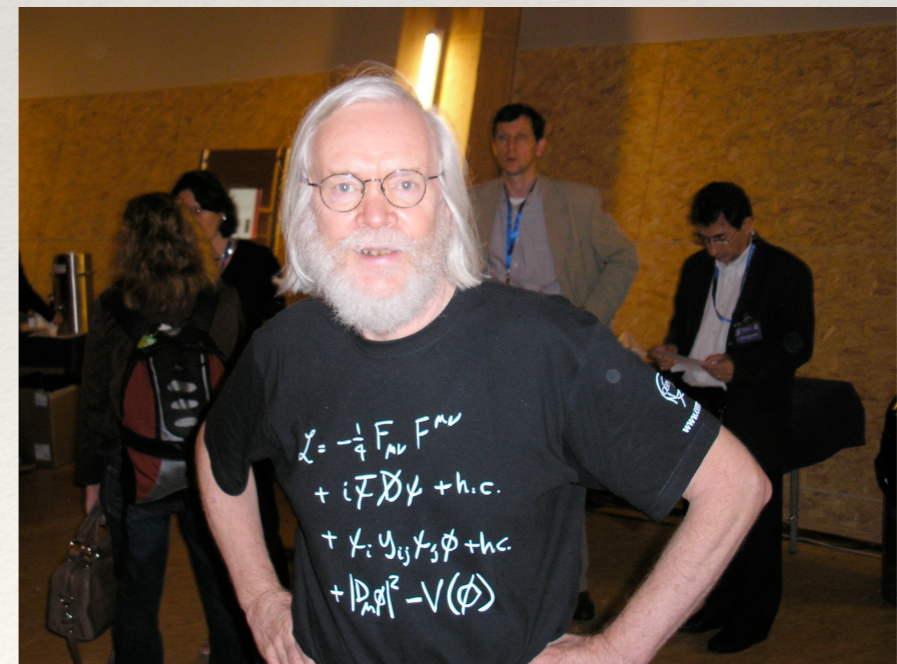

# The standard model

- ❖ Objects with very small dimensions  $\sim 10^{-18}$  m and very high energy → mathematical description = you put together quantum field theory, you make it renormalizable, particle physics.
- ❖ Theory built on symmetry principles: gauge symmetry → vector bosons mediating electromagnetic, weak and strong interactions spontaneously in the theory once corresponding gauge symmetry is broken
- ❖ Ad hoc ingredients are moreover added in the mathematical model to fit experimental observations:
  - ❖ charged weak interaction couples only to left chiral fermions,
  - ❖ non massive neutrinos,
  - ❖ Higgs potential,
  - ❖ quark mixing through charged weak interaction,
  - ❖ 3 fermion families,
  - ❖ ...

$$\begin{aligned}
 \mathcal{L} = & -\frac{1}{2}\partial_\nu g_\mu^a \partial_\nu g_\mu^a - g_s f^{abc} \partial_\mu g_\nu^a g_\mu^b g_\nu^c - \frac{1}{4}g_s^2 f^{abc} f^{ade} g_\mu^b g_\nu^c g_\mu^d g_\nu^e + \\
 & \frac{1}{2}ig_s^2 (\bar{q}_i^\sigma \gamma^\mu q_j^\sigma) g_\mu^a + \bar{G}^a \partial^2 G^a + g_s f^{abc} \partial_\mu \bar{G}^a G^b g_\mu^c - \partial_\nu W_\mu^+ \partial_\nu W_\mu^- - \\
 & M^2 W_\mu^+ W_\mu^- - \frac{1}{2}\partial_\nu Z_\mu^0 \partial_\nu Z_\mu^0 - \frac{1}{2c_w^2} M^2 Z_\mu^0 Z_\mu^0 - \frac{1}{2}\partial_\mu A_\nu \partial_\mu A_\nu - \frac{1}{2}\partial_\mu H \partial_\mu H - \\
 & \frac{1}{2}m_h^2 H^2 - \partial_\mu \phi^+ \partial_\mu \phi^- - M^2 \phi^+ \phi^- - \frac{1}{2}\partial_\mu \phi^0 \partial_\mu \phi^0 - \frac{1}{2c_w^2} M \phi^0 \phi^0 - \beta_h \left[ \frac{2M^2}{g^2} + \right. \\
 & \left. \frac{2M}{g} H + \frac{1}{2}(H^2 + \phi^0 \phi^0 + 2\phi^+ \phi^-) \right] + \frac{2M^4}{g^2} \alpha_h - igc_w [\partial_\nu Z_\mu^0 (W_\mu^+ W_\nu^- - \\
 & W_\nu^+ W_\mu^-) - Z_\nu^0 (W_\mu^+ \partial_\nu W_\mu^- - W_\mu^- \partial_\nu W_\mu^+) + Z_\mu^0 (W_\nu^+ \partial_\nu W_\mu^- - \\
 & W_\nu^- \partial_\nu W_\mu^+)] - igs_w [\partial_\nu A_\mu (W_\mu^+ W_\nu^- - W_\nu^+ W_\mu^-) - A_\nu (W_\mu^+ \partial_\nu W_\mu^- - \\
 & W_\mu^- \partial_\nu W_\mu^+) + A_\mu (W_\nu^+ \partial_\nu W_\mu^- - W_\nu^- \partial_\nu W_\mu^+)] - \frac{1}{2}g^2 W_\mu^+ W_\mu^- W_\nu^+ W_\nu^- + \\
 & \frac{1}{2}g^2 W_\mu^+ W_\nu^- W_\mu^+ W_\nu^- + g^2 c_w^2 (Z_\mu^0 W_\mu^+ Z_\nu^0 W_\nu^- - Z_\mu^0 Z_\nu^0 W_\mu^+ W_\nu^-) + \\
 & g^2 s_w^2 (A_\mu W_\mu^+ A_\nu W_\nu^- - A_\mu A_\nu W_\mu^+ W_\nu^-) + g^2 s_w c_w [A_\mu Z_\nu^0 (W_\mu^+ W_\nu^- - \\
 & W_\nu^+ W_\mu^-) - 2A_\mu Z_\mu^0 W_\nu^+ W_\nu^-] - g\alpha [H^3 + H\phi^0 \phi^0 + 2H\phi^+ \phi^-] - \\
 & \frac{1}{8}g^2 \alpha_h [H^4 + (\phi^0)^4 + 4(\phi^+ \phi^-)^2 + 4(\phi^0)^2 \phi^+ \phi^- + 4H^2 \phi^+ \phi^- + 2(\phi^0)^2 H^2] - \\
 & gMW_\mu^+ W_\mu^- H - \frac{1}{2}g \frac{M}{c_w^2} Z_\mu^0 Z_\mu^0 H - \frac{1}{2}ig [W_\mu^+ (\phi^0 \partial_\mu \phi^- - \phi^- \partial_\mu \phi^0) - \\
 & W_\mu^- (\phi^0 \partial_\mu \phi^+ - \phi^+ \partial_\mu \phi^0)] + \frac{1}{2}g [W_\mu^+ (H\partial_\mu \phi^- - \phi^- \partial_\mu H) - W_\mu^- (H\partial_\mu \phi^+ - \\
 & \phi^+ \partial_\mu H)] + \frac{1}{2}g \frac{1}{c_w} Z_\mu^0 (H\partial_\mu \phi^0 - \phi^0 \partial_\mu H) - ig \frac{s_w^2}{c_w} MZ_\mu^0 (W_\mu^+ \phi^- - W_\mu^- \phi^+) + \\
 & igs_w MA_\mu (W_\mu^+ \phi^- - W_\mu^- \phi^+) - ig \frac{1-2c_w^2}{2c_w} Z_\mu^0 (\phi^+ \partial_\mu \phi^- - \phi^- \partial_\mu \phi^+) + \\
 & igs_w A_\mu (\phi^+ \partial_\mu \phi^- - \phi^- \partial_\mu \phi^+) - \frac{1}{4}g^2 W_\mu^+ W_\mu^- [H^2 + (\phi^0)^2 + 2\phi^+ \phi^-] - \\
 & \frac{1}{4}g^2 \frac{1}{c_w^2} Z_\mu^0 Z_\mu^0 [H^2 + (\phi^0)^2 + 2(2s_w^2 - 1)^2 \phi^+ \phi^-] - \frac{1}{2}g^2 \frac{s_w^2}{c_w} Z_\mu^0 \phi^0 (W_\mu^+ \phi^- + \\
 & W_\mu^- \phi^+) - \frac{1}{2}ig^2 \frac{s_w^2}{c_w} Z_\mu^0 H (W_\mu^+ \phi^- - W_\mu^- \phi^+) + \frac{1}{2}g^2 s_w A_\mu \phi^0 (W_\mu^+ \phi^- + \\
 & W_\mu^- \phi^+) + \frac{1}{2}ig^2 s_w A_\mu H (W_\mu^+ \phi^- - W_\mu^- \phi^+) - g^2 \frac{s_w}{c_w} (2c_w^2 - 1) Z_\mu^0 A_\mu \phi^+ \phi^- - \\
 & g^1 s_w^2 A_\mu A_\mu \phi^+ \phi^- - \bar{e}^\lambda (\gamma \partial + m_e^\lambda) e^\lambda - \bar{\nu}^\lambda \gamma \partial \nu^\lambda - \bar{u}_j^\lambda (\gamma \partial + m_u^\lambda) u_j^\lambda - \\
 & \bar{d}_j^\lambda (\gamma \partial + m_d^\lambda) d_j^\lambda + igs_w A_\mu [-(\bar{e}^\lambda \gamma^\mu e^\lambda) + \frac{2}{3}(\bar{u}_j^\lambda \gamma^\mu u_j^\lambda) - \frac{1}{3}(\bar{d}_j^\lambda \gamma^\mu d_j^\lambda)] + \\
 & \frac{ig}{4c_w} Z_\mu^0 [(\bar{\nu}^\lambda \gamma^\mu (1 + \gamma^5) \nu^\lambda) + (\bar{e}^\lambda \gamma^\mu (4s_w^2 - 1 - \gamma^5) e^\lambda) + (\bar{u}_j^\lambda \gamma^\mu (\frac{4}{3}s_w^2 - \\
 & 1 - \gamma^5) u_j^\lambda) + (\bar{d}_j^\lambda \gamma^\mu (1 - \frac{8}{3}s_w^2 - \gamma^5) d_j^\lambda)] + \frac{ig}{2\sqrt{2}} W_\mu^+ [(\bar{\nu}^\lambda \gamma^\mu (1 + \gamma^5) e^\lambda) + \\
 & (\bar{u}_j^\lambda \gamma^\mu (1 + \gamma^5) C_{\lambda k} d_j^k)] + \frac{ig}{2\sqrt{2}} W_\mu^- [(\bar{e}^\lambda \gamma^\mu (1 + \gamma^5) \nu^\lambda) + (\bar{d}_j^\lambda C_{\lambda k}^\dagger \gamma^\mu (1 + \\
 & \gamma^5) u_j^\lambda)] + \frac{ig}{2\sqrt{2}} \frac{m_d^\lambda}{M} [-\phi^+ (\bar{\nu}^\lambda (1 - \gamma^5) e^\lambda) + \phi^- (\bar{e}^\lambda (1 + \gamma^5) \nu^\lambda)] - \\
 & \frac{g}{2} \frac{m_d^\lambda}{M} [H(\bar{e}^\lambda e^\lambda) + i\phi^0 (\bar{e}^\lambda \gamma^5 e^\lambda)] + \frac{ig}{2M\sqrt{2}} \phi^+ [-m_d^\lambda (\bar{u}_j^\lambda C_{\lambda k} (1 - \gamma^5) d_j^k) + \\
 & m_u^\lambda (\bar{u}_j^\lambda C_{\lambda k} (1 + \gamma^5) d_j^k)] + \frac{ig}{2M\sqrt{2}} \phi^- [m_d^\lambda (\bar{d}_j^\lambda C_{\lambda k}^\dagger (1 + \gamma^5) u_j^k) - m_u^\lambda (\bar{d}_j^\lambda C_{\lambda k}^\dagger (1 - \\
 & \gamma^5) u_j^k)] - \frac{g}{2} \frac{m_d^\lambda}{M} H(\bar{u}_j^\lambda u_j^\lambda) - \frac{g}{2} \frac{m_d^\lambda}{M} H(\bar{d}_j^\lambda d_j^\lambda) + \frac{ig}{2} \frac{m_d^\lambda}{M} \phi^0 (\bar{u}_j^\lambda \gamma^5 u_j^\lambda) - \\
 & \frac{ig}{2} \frac{m_d^\lambda}{M} \phi^0 (\bar{d}_j^\lambda \gamma^5 d_j^\lambda) + \bar{X}^+ (\partial^2 - M^2) X^+ + \bar{X}^- (\partial^2 - M^2) X^- + \bar{X}^0 (\partial^2 - \\
 & \frac{M^2}{c_w^2}) X^0 + \bar{Y} \partial^2 Y + igc_w W_\mu^+ (\partial_\mu \bar{X}^0 X^- - \partial_\mu \bar{X}^+ X^0) + igs_w W_\mu^+ (\partial_\mu \bar{Y} X^- - \\
 & \partial_\mu \bar{X}^+ Y) + igc_w W_\mu^- (\partial_\mu \bar{X}^- X^0 - \partial_\mu \bar{X}^0 X^+) + igs_w W_\mu^- (\partial_\mu \bar{X}^- Y - \\
 & \partial_\mu \bar{Y} X^+) + igc_w Z_\mu^0 (\partial_\mu \bar{X}^+ X^+ - \partial_\mu \bar{X}^- X^-) + igs_w A_\mu (\partial_\mu \bar{X}^+ X^+ - \\
 & \partial_\mu \bar{X}^- X^-) - \frac{1}{2}gM [\bar{X}^+ X^+ H + \bar{X}^- X^- H + \frac{1}{c_w^2} \bar{X}^0 X^0 H] + \\
 & \frac{1-2c_w^2}{2c_w} igM [\bar{X}^+ X^0 \phi^+ - \bar{X}^- X^0 \phi^-] + \frac{1}{2c_w} igM [\bar{X}^0 X^- \phi^+ - \bar{X}^0 X^+ \phi^-] + \\
 & igMs_w [\bar{X}^0 X^- \phi^+ - \bar{X}^0 X^+ \phi^-] + \frac{1}{2}igM [\bar{X}^+ X^+ \phi^0 - \bar{X}^- X^- \phi^0]
 \end{aligned}$$



# Ingredients of the Lagrangian

- ❖ Objects in quantum field theory are **quantum fields**, defined at all points in space  $\mathbf{r}$  and time  $t$ :
  - ❖ **spinor fermion** fields (matter)  $\psi$
  - ❖ **vector boson** fields (interactions)  $W_1, W_2, W_3, B, G_a$  ( $a = 1, 8$ )
  - ❖ **scalar Higgs** field  $\phi$
- ❖ Notation:
  - ❖  $\mu = 0, 1, 2, 3$  index corresponds resp. to  $t, x, y, z$  (Lorentz index).  
Definition:  $\partial_\mu = (\partial_t, \partial_x, \partial_y, \partial_z)$  and  $\partial^\mu = (\partial_t, -\partial_x, -\partial_y, -\partial_z)$ .
  - ❖  $\gamma$  matrices: Dirac  $4 \times 4$  complex matrices  $\{\gamma^0, \gamma^1, \gamma^2, \gamma^3\}$  with anti-commutation relations.  
 $\gamma^5 = i \gamma^0 \gamma^1 \gamma^2 \gamma^3$
  - ❖ Notation:  $\bar{\psi} = \psi^\dagger \gamma^0$   
 $\bar{\psi}$  is the hermitian adjoint and is a  $1 \times 4$  matrix, while  $\psi$  is a  $4 \times 1$  matrix.
- ❖ Equations of motion of a classical object is obtained from the **Lagrangian** (density):  $L = T - V$   
 $T$  and  $V$  are kinetic and potential energies.  
With a quantum spinor field, **kinetic** and **mass** terms are:  $L = \bar{\psi} i \gamma_\mu \partial^\mu \psi - m \bar{\psi} \psi$
- Additional terms: **coupling** between different fields.
- Feynman rules used for calculation are derived from Lagrangian terms.

# The Wu experiment

- ❖ Until 1956, physics laws were expected to be unchanged following a **Parity discrete transformation (inversion)  $\mathbf{x} \rightarrow -\mathbf{x}$** . ( $\mathbf{x}$  stands for the 3-dim space vector)  
It seems still valid for electromagnetic and strong interactions, but not weak interaction.
- ❖ Wu experiment of the  $\beta$  decay of the  $^{60}\text{Co}$  nucleus (proposed by Lee and Wang, Nobel prize 1957):

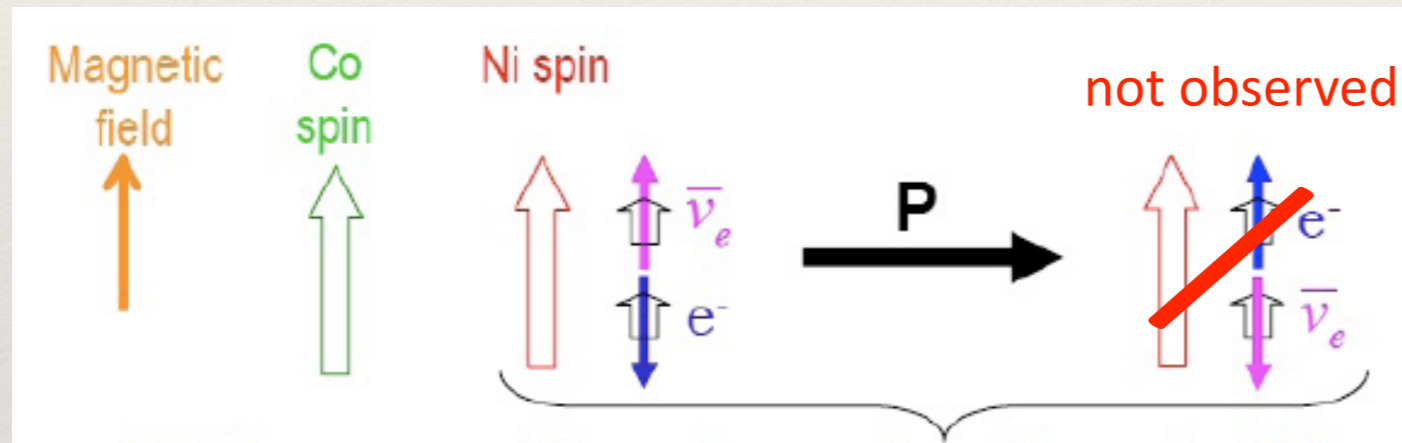
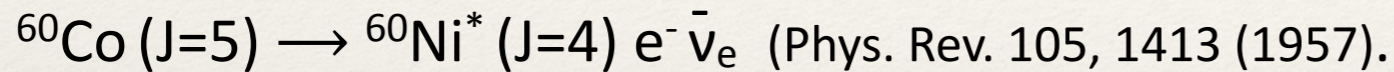

if P is a symmetry, both configurations should be equally observed.

Measurement of the ratio of  $e^-$  emitted in same direction as magnetic field: observation of a **maximal violation of parity P by charged weak interaction**.

$$P \psi(\mathbf{x}, t) = \psi(-\mathbf{x}, t)$$

# The Goldhaber experiment (1)

❖ Goldhaber experiment (Phys. Rev. 109, 1015 (1958):

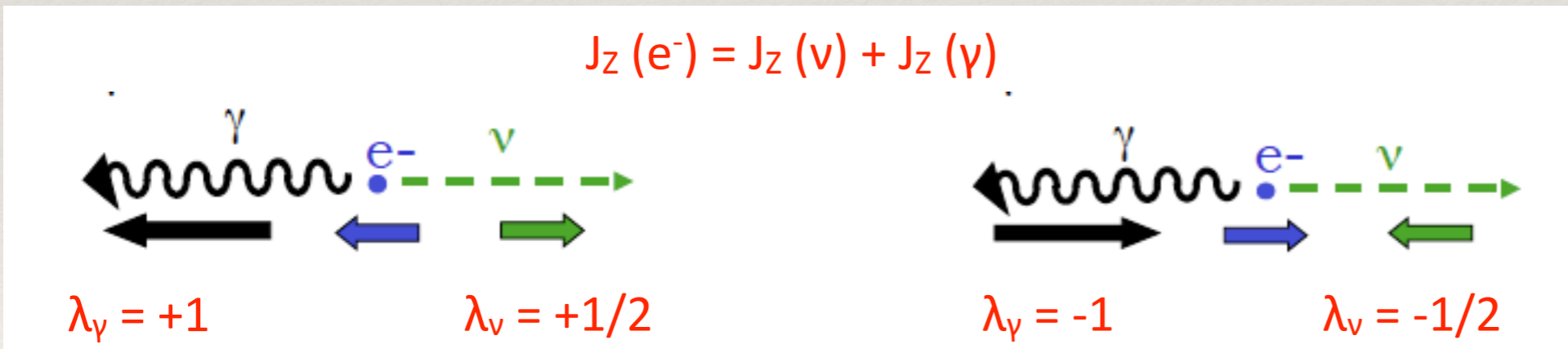
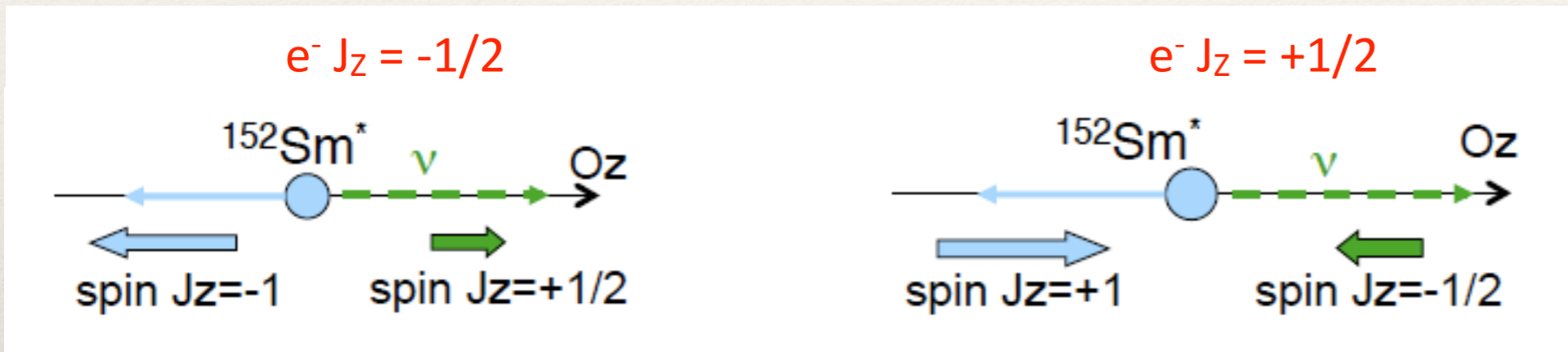
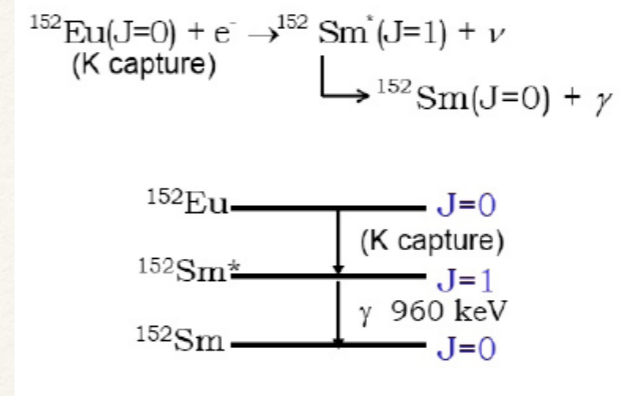
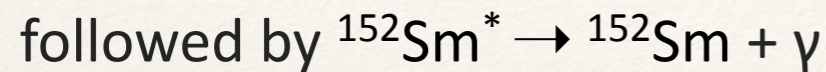
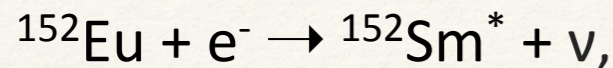

$$\text{Helicity } \lambda = \frac{\vec{J} \cdot \vec{p}}{|\vec{p}|}$$

Measurement of the polarisation of the  $\gamma$  from electron capture by Eu: observation that helicity of forward  $\gamma$  is negative, hence neutrinos have negative helicities.

# The Goldhaber experiment (2)

- ❖ Interpretation of observation: discrete transformations by C (charge conjugation) and P (parity) do not lead to symmetric configurations in weak charge interaction.

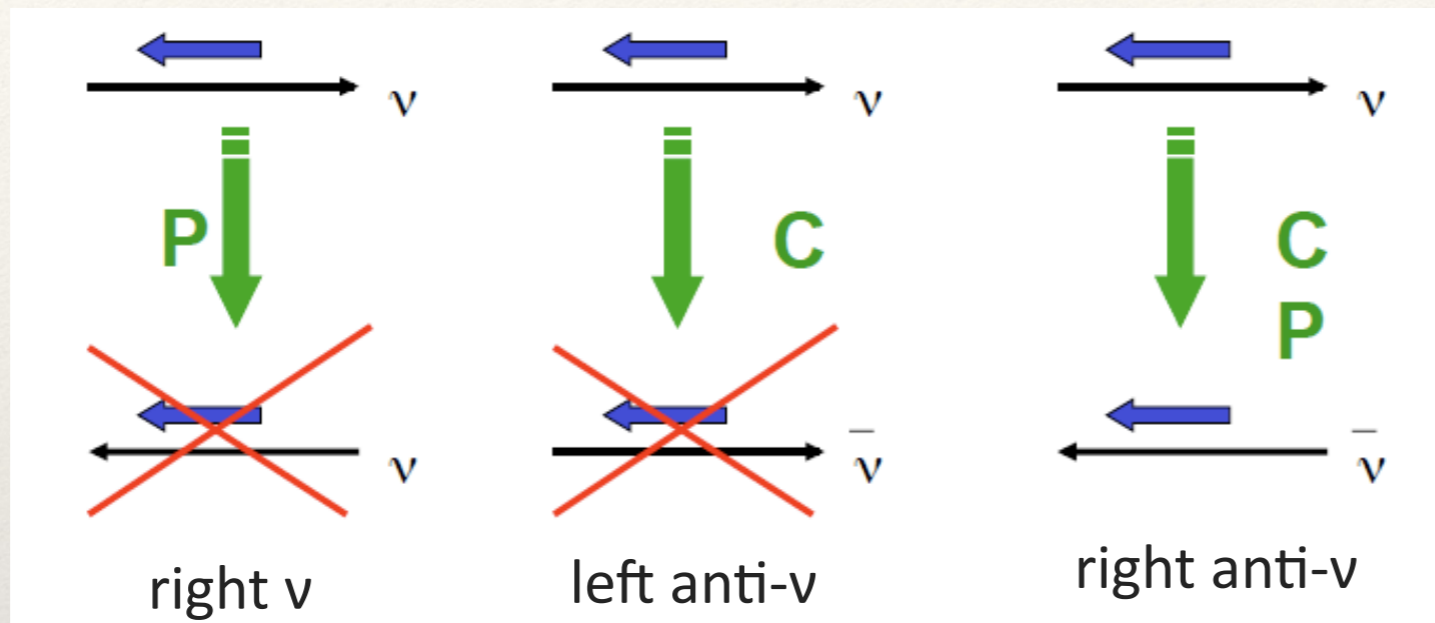

- ➔ this feature must be described by theory: weak charge current interacts only with left fermions and right anti-fermions.

- ❖ Charged weak interaction features a pure V-A structure (vector - axialvector). Dirac spinors  $\psi$  can be projected on right or left chirality with projection operators:

$$P_L = (1 - \gamma_5) / 2, \quad P_R = (1 + \gamma_5) / 2 \quad [\text{not the same operator } P \text{ as parity}]$$

$$\psi_L = P_L \psi \quad P_L + P_R = \text{Id} \quad P_L^2 = P_L$$

For non-massive particles, helicity = chirality.

# Gauge symmetries

- ❖ Symmetries play an important role in physics.

Noether's theorem: **every observed symmetry translates into a conserved quantity.**

Continuous symmetries w.r.t.: time translation  $\Delta t \rightarrow$  energy conservation, space translation  $\Delta r \rightarrow$  momentum conservation, rotation  $\Delta\theta \rightarrow$  angular momentum conservation.

- ❖ In a space of quantum field: **gauge symmetries.**

Physics laws do not depend on an arbitrary phase and the Lagrangian  $L = \bar{\psi} i \gamma_\mu \partial^\mu \psi - m \bar{\psi} \psi$  remains invariant under a **global phase  $\alpha$  transformation**:

if  $\psi(x) \rightarrow \psi'(x) = e^{i\alpha} \psi(x)$  and  $\bar{\psi}(x) \rightarrow \bar{\psi}'(x) = e^{-i\alpha} \bar{\psi}(x)$  then  $L \rightarrow L' = L$ .

- ❖ **Symmetry groups**: these symmetries can be represented by a set (a group) of Unitarity  $n \times n$  matrices  $U(n)$  or Special (with determinant = 1) Unitarity  $n \times n$  matrices  $SU(n)$ .
  - ❖ Electromagnetic interaction: described by  $U(1)$ .
  - ❖ Weak interaction:  $SU(2)$ .
  - ❖ Strong interaction:  $SU(3)$ .

# Weak isospin and $SU(2)_L$

- ❖ **Strong isospin** proposed by Heisenberg in 1932: proton and neutron are similar but their electric charges, seen by the electromagnetic interaction.  
They are seen by the strong interaction as two different physics states of one same particle, the nucleon.  
Similar to up and down spin states of electrons, similar mathematical formalism.  
→ introduction of 2 new quantum numbers of same type as Spin: total Isospin  $I$  and its projection  $I_3$  (N.B. :  $I_3$  is not an arbitrary projection like for the spin, but on physics states  $n$  and  $p$ , let us say on a “flavour” axis).
- ❖  $\nu_L$  transforms in  $e_L$  via a charged weak  $W^+$  boson:  $e_L$  and  $\nu_L$  are seen by the charged weak interaction as two physics states (two different flavours) of one same particle.  
→ similar to strong Isospin and neutron and proton: neutrino and electron are allocated two new quantum numbers, the **weak isospin  $T$  and its projection on flavour axis  $T_3$** .  
 $e_L$  and  $\nu_L$  (and all fermions) are grouped in a weak isospin doublet of  $SU(2)$  left:

$$\begin{pmatrix} \nu_{eL} \\ e_L \end{pmatrix} \quad \begin{pmatrix} \nu_{\mu L} \\ \mu_L \end{pmatrix} \quad \begin{pmatrix} \nu_{\tau L} \\ \tau_L \end{pmatrix} \quad \begin{pmatrix} u_L \\ d_L \end{pmatrix} \quad \begin{pmatrix} c_L \\ s_L \end{pmatrix} \quad \begin{pmatrix} t_L \\ b_L \end{pmatrix}$$

# Covariant derivative

❖ **Local gauge symmetry:** transformation  $\psi(x) \rightarrow \psi'(x) = e^{i\alpha(x)} \psi(x)$

→ under such a local phase transformation, the Lagrangian  $L = \bar{\psi} i \gamma_\mu \partial^\mu \psi - m \bar{\psi} \psi$  would not remain unchanged, an extra term appears because of the derivative  $\partial^\mu$ :

$$\partial^\mu e^{i\alpha(x)} \psi(x) = e^{i\alpha(x)} \partial^\mu \psi(x) + i e^{i\alpha(x)} \psi(x) \partial^\mu \alpha(x).$$

To keep the Lagrangian invariant under a local gauge transformation, a **covariant derivative**  $D^\mu$  is defined transforming like the field:  $D^\mu \psi \rightarrow (D^\mu \psi)' = e^{i\alpha(x)} (D^\mu \psi)$

$\partial^\mu$  is replaced by  $D^\mu$ , and invariance of  $L$  is established under local phase transformation by adding an additional term in  $D^\mu$  expression **to compensate for the extra  $\partial^\mu \alpha(x)$  term:**

$$D^\mu = \partial^\mu - i e A^\mu(x)$$

with the transformation law of the new  $A_\mu$  quantity:  $A_\mu \rightarrow A_\mu' = A_\mu + \frac{1}{e} \partial_\mu \alpha(x)$ .

→ the local gauge invariance is preserved by introducing a new gauge field  $A_\mu$

This quantity is the gauge field of the corresponding interaction.

Each generator of a given symmetry group corresponds to a gauge boson: 1 boson (photon) in  $U(1)$ , 3 bosons ( $W^+$ ,  $W^-$ ,  $Z$ ) in  $SU(2)$  and 8 bosons (gluons) in  $SU(3)$ .

# Higgs mechanism (1)

- ❖ A mass term for the photon in the Lagrangian would not be invariant under U(1):

$$\frac{1}{2}m_\gamma^2 A_\mu A^\mu \rightarrow \frac{1}{2}m_\gamma^2 A'_\mu A'^\mu = \frac{1}{2}m_\gamma^2 (A_\mu + \partial_\mu \alpha) (A^\mu + \partial^\mu \alpha) \neq \frac{1}{2}m_\gamma^2 A_\mu A^\mu$$

Actually the photon is massless, but same kind of argument holds for weak bosons and fermions, which are obviously massive particles.

→ introducing directly a mass term in the Lagrangian does not observe the required  $SU(2)_L \times U(1)_Y$  symmetry.

→ a trick is needed to describe massive particles in the theory, theory which predictions were very precisely tested otherwise.

- ❖ The Higgs trick: introduce ad hoc in the Lagrangian a new scalar field  $\phi$ , which potential observes the right symmetry but its fundamental not. The set of possible fundamentals is symmetric, but once you choose one given fundamental, it is not anymore. This is called a spontaneous symmetry breaking.

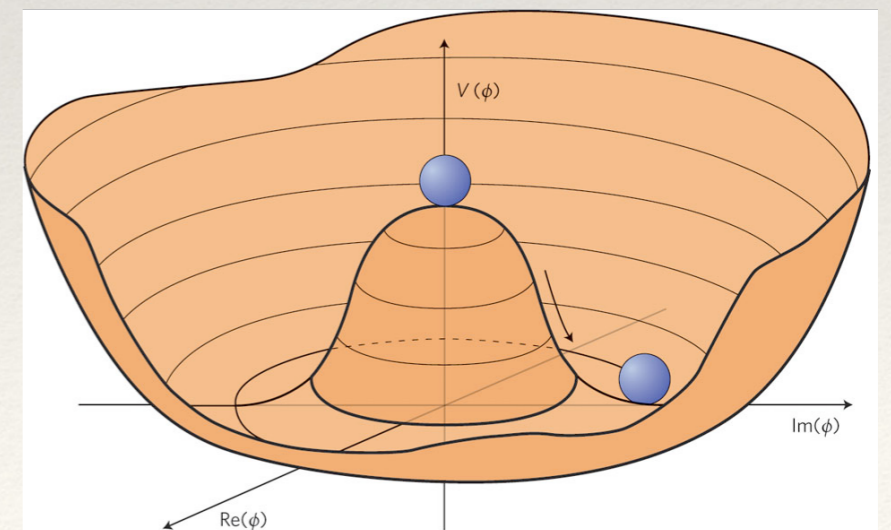



## Higgs mechanism (2)

- ❖ This Higgs field is an  $SU(2)_L$  doublet:  $\phi = \begin{pmatrix} \phi^0 = \phi_1 + i\phi_2 \\ \phi^+ = \phi_3 + i\phi_4 \end{pmatrix}$

The potential is:  $V = -\mu^2 \phi^+ \phi + \lambda(\phi^+ \phi)^2$

→ 2 free parameters,  $\mu$  (related to the Higgs mass) and  $\lambda$  (related to the Higgs self-coupling), which values are not predicted by theory, are introduced in the theory.

- ❖ **Generating masses:** (in very short)

The Higgs field interacts with gauge bosons, and this interaction makes them **massive**. Each mass costs one degree of freedom of the Higgs field.

One  $SU(2)$  doublet has 4 degrees of freedom:  $\phi_1, \phi_2, \phi_3, \phi_4$ .

3 gauge bosons are massive:  $W^+, W^-$  and  $Z$ .

→ 1 degree of freedom remains: the Higgs particle.

- ❖ **Fermions masses:** generated by hand by adding a Higgs-fermion interaction term (Yukawa coupling).
- ❖ **Weak boson and fermion mass values are not predicted by the theory.**
- ❖ Almost 50 years of search: existence of the Higgs boson was **postulated in 1964** and it was only **discovered in 2012 at LHC**.

# Lagrangian of the standard model (1)

$$L = -\frac{1}{4}W_{\alpha}^{\mu\nu}W_{\mu\nu}^{\alpha} - \frac{1}{4}B^{\mu\nu}B_{\mu\nu}$$

kinetic terms of  
electroweak gauge bosons

$$+i \sum_{\text{fermions}} \bar{\psi} \gamma^{\mu} \partial_{\mu} \psi$$

kinetic term of fermions

$$+ \frac{g}{\sqrt{2}} \sum_{\text{leptons}} \bar{\psi}_{\nu} \gamma^{\mu} \frac{(1 - \gamma^5)}{2} \psi_{\ell} W_{\mu}^{-} + h.c.$$

lepton-W interaction

$$+ \frac{g}{\sqrt{2}} \sum_{\text{quarks}} \bar{\psi}_u \gamma^{\mu} \frac{(1 - \gamma^5)}{2} V_{CKM}^{ud} \psi_d W_{\mu}^{-} + h.c.$$

quark-W interaction

$$+ g \sin \theta_W \sum_{\text{fermions}} \bar{\psi} \gamma^{\mu} Q_f \psi A_{\mu}$$

fermion- $\gamma$  interaction

$$+ \frac{g}{\cos \theta_W} \sum_{\text{fermions}} \bar{\psi} \gamma^{\mu} \frac{(g_v - g_a \gamma^5)}{2} \psi Z_{\mu}$$

fermion-Z interaction

## Lagrangian of the standard model (2)

$$(\dots) + \frac{1}{2} \partial_\mu \rho \partial^\mu \rho + \frac{1}{2} M_H^2 \rho^2 - \frac{\mu^2 v^2}{4}$$

Higgs kinetic and mass term and potential

$$+ \frac{g^2 v^2}{4} W_\mu^- W^{+\mu} + \frac{(g^2 + g'^2) v^2}{8} Z_\mu Z^\mu$$

W and Z mass term

$$+ \sum_{\text{fermions}} m_f \bar{\psi} \psi$$

fermion mass term

# Lagrangian of the standard model (3)

$$(\dots) + \lambda v \rho^3 + \frac{\lambda}{4} \rho^4$$

Higgs self-interaction

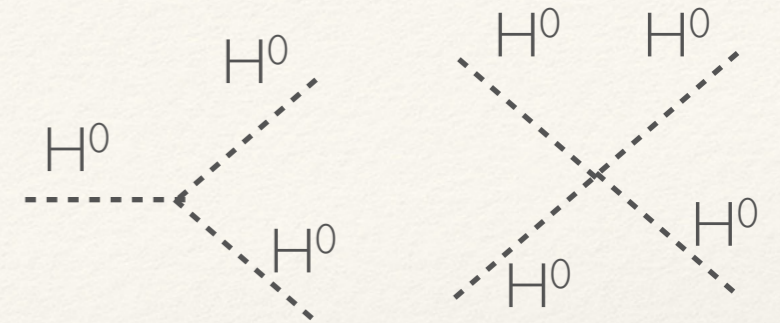

$$+ \frac{g^2}{4} (2v\rho + \rho^2) W_\mu^- W^{+\mu}$$

Higgs-W interaction

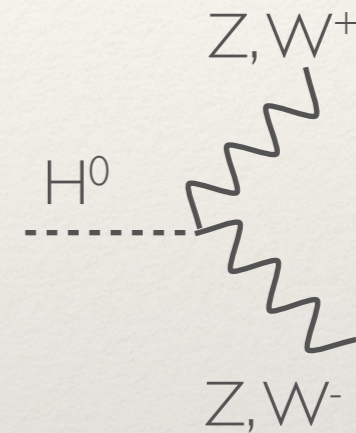

$$+ \frac{g^2}{8 \cos^2 \theta_W} (2v\rho + \rho^2) Z_\mu Z^\mu$$

Higgs-Z interaction

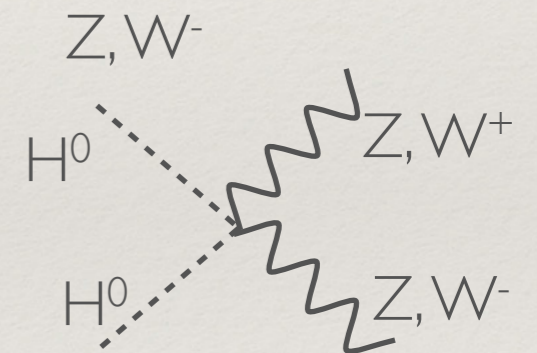

$$+ \sum_{fermions} \frac{m_f}{v} \rho \bar{\psi} \psi$$

Higgs-fermion interaction



# Feynman diagrams

- ❖ A Feynman diagram is a **graphic representation** of a **perturbative series** used to compute the probability transition between initial and final states.
  - ❖ Each part (e.g., fermion line, boson propagator, ...) correspond to a Lagrangian term.
  - ❖ The precision of the calculation is increased by taking **increasing vertices** into account.
  - ❖ Perturbative development because  $|\text{coupling constant}| < 1$ . This is true for electromagnetic and weak interactions, and for strong interaction at high momentum. Soft strong processes are not perturbative and are calculated with models (cf. Lattice QCD).

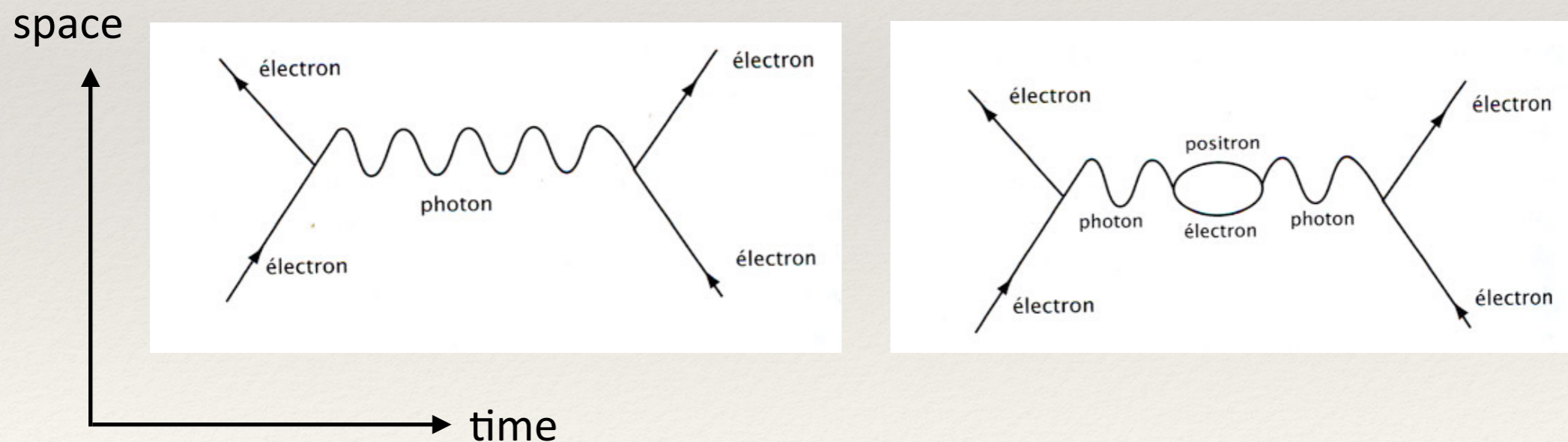

# Predictions in the framework of the SM

- ❖ Unfortunately, 18 (+5) quantity values are unknown in the SM, i.e. free parameters:
  - ❖ 9 fermion masses,
  - ❖ 3 coupling constants of weak, electromagnetic and strong interactions,
  - ❖ 4 parameters to describe the CKM matrix (discussed in next slides),
  - ❖ 2 parameters for the Higgs potential ( $\mu$  and  $\lambda$ ).
  - ❖ 5 quantities are put to 0 by hand, according to observation: 3 neutrino masses, CP violation phase  $\theta_{\text{strong}}$  in strong interaction.

➔ measurements are needed, used as inputs to predict other physics quantities, because relations between quantities can be written.

Some quantities can be very precisely measured (e.g., charged lepton and top quark masses), other not (e.g., quark masses, because light quarks are always bounded in hadrons).

- ❖ Relations between different quantities imply quantum loops (perturbative development with an increased number of vertices).

Contribution of unknown particles through quantum loops, e.g. Higgs boson until 2012: predictions were made as a function of the unknown Higgs mass.

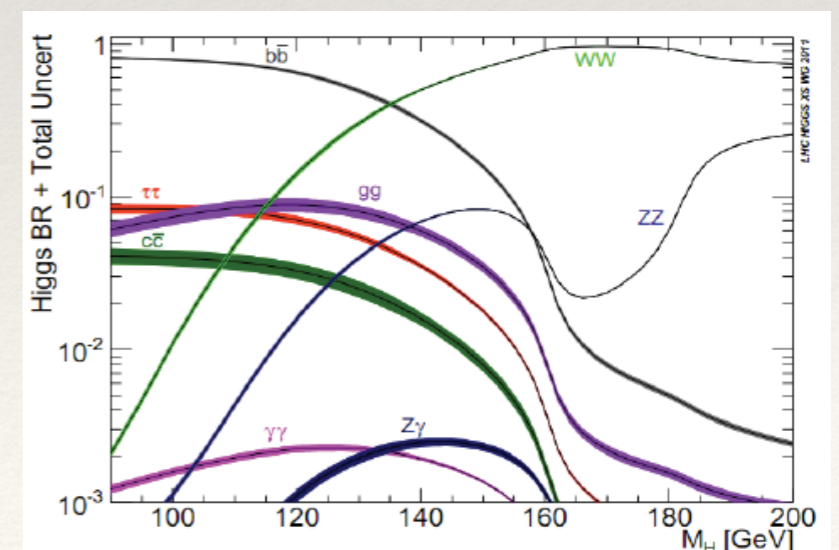

# Lattice QCD (1)

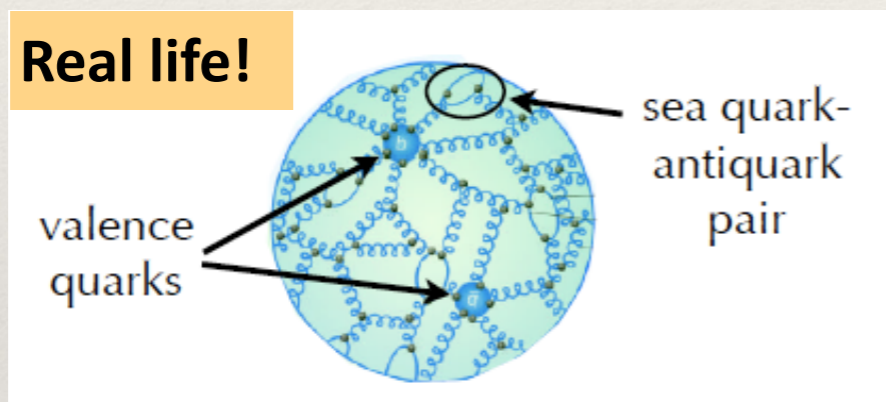
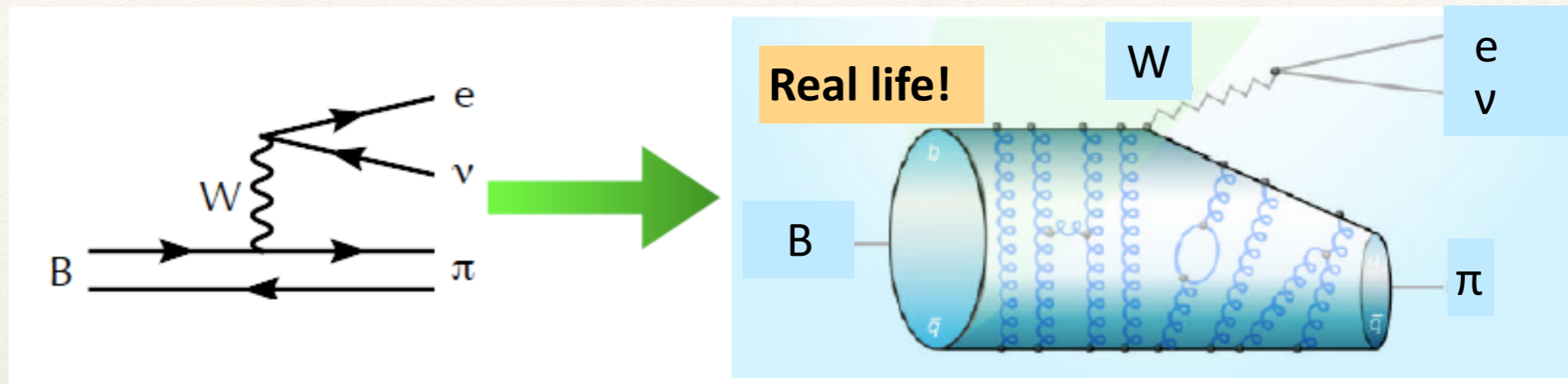

Infinite number of quarks from the sea!

- ❖ Low energy strong interaction processes cannot be computed perturbatively. Modelisation with quantities like Bag factor, decay constant, form factor, ..., computed with the Lattice QCD technique.

## Lattice QCD (2)

- ❖ Field theory in continuous space-time is replaced with a discrete lattice theory:

$$\partial\psi(x) \longrightarrow \frac{\psi(x+a) - \psi(x-a)}{2a}$$
$$\psi(x) = \int \frac{d^4k}{(2\pi)^4} e^{-ik\cdot x} \tilde{\psi}(k) \longrightarrow \sum_k e^{-ik\cdot x} \tilde{\psi}(k)$$

- ❖ Calculation made on each node from the Lattice. Integrals are approximated by Sums in the limit  $a \rightarrow 0$  and  $L \rightarrow \infty$ .

- ❖ **CPU power** governs the precision on theoretical predictions. Number of quark flavours and realistic description of quark dynamics (massive quarks) proportional to CPU. Improvement of precision can be  $\pm$  predicted (though end of Moore law).

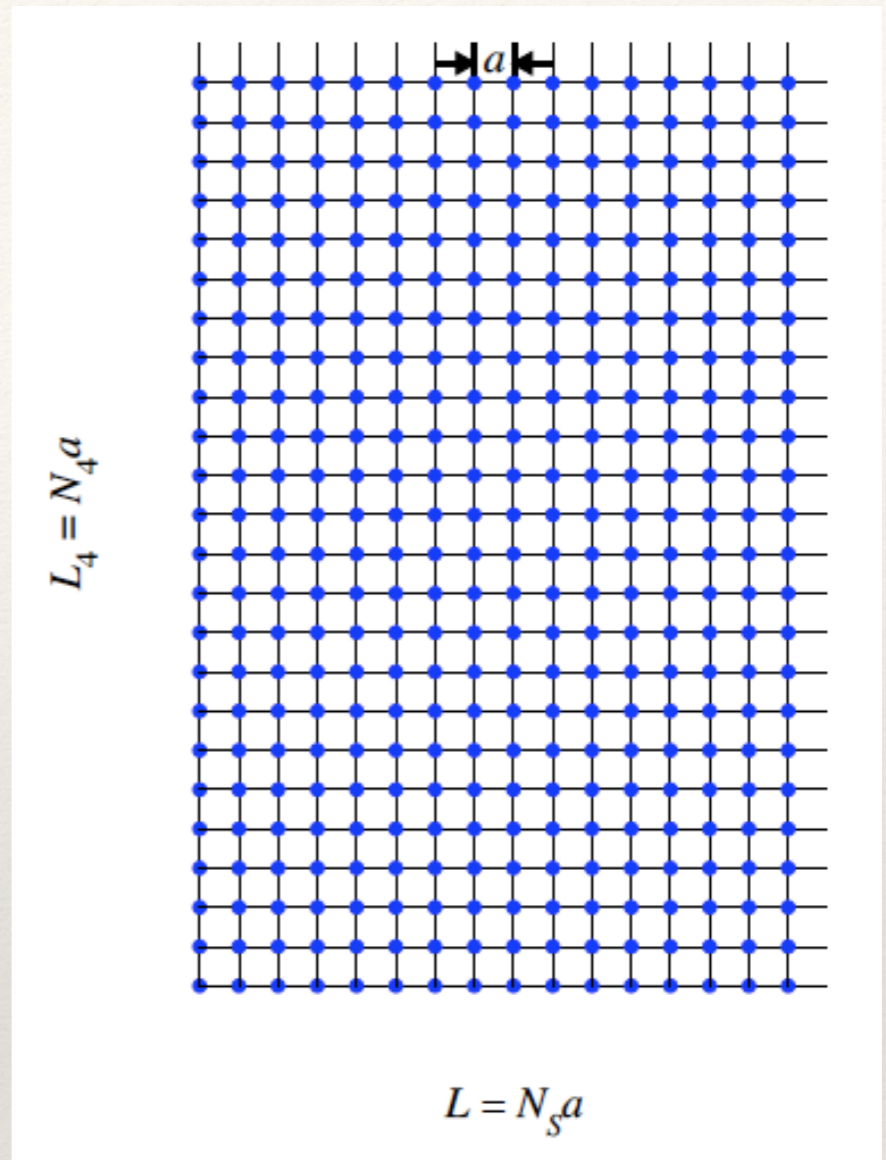



# Course outline

- ❖ Introduction to the standard model
- ❖ **The CKM formalism**
- ❖ Beyond the SM
- ❖ Effective Lagrangian of physics beyond the standard model

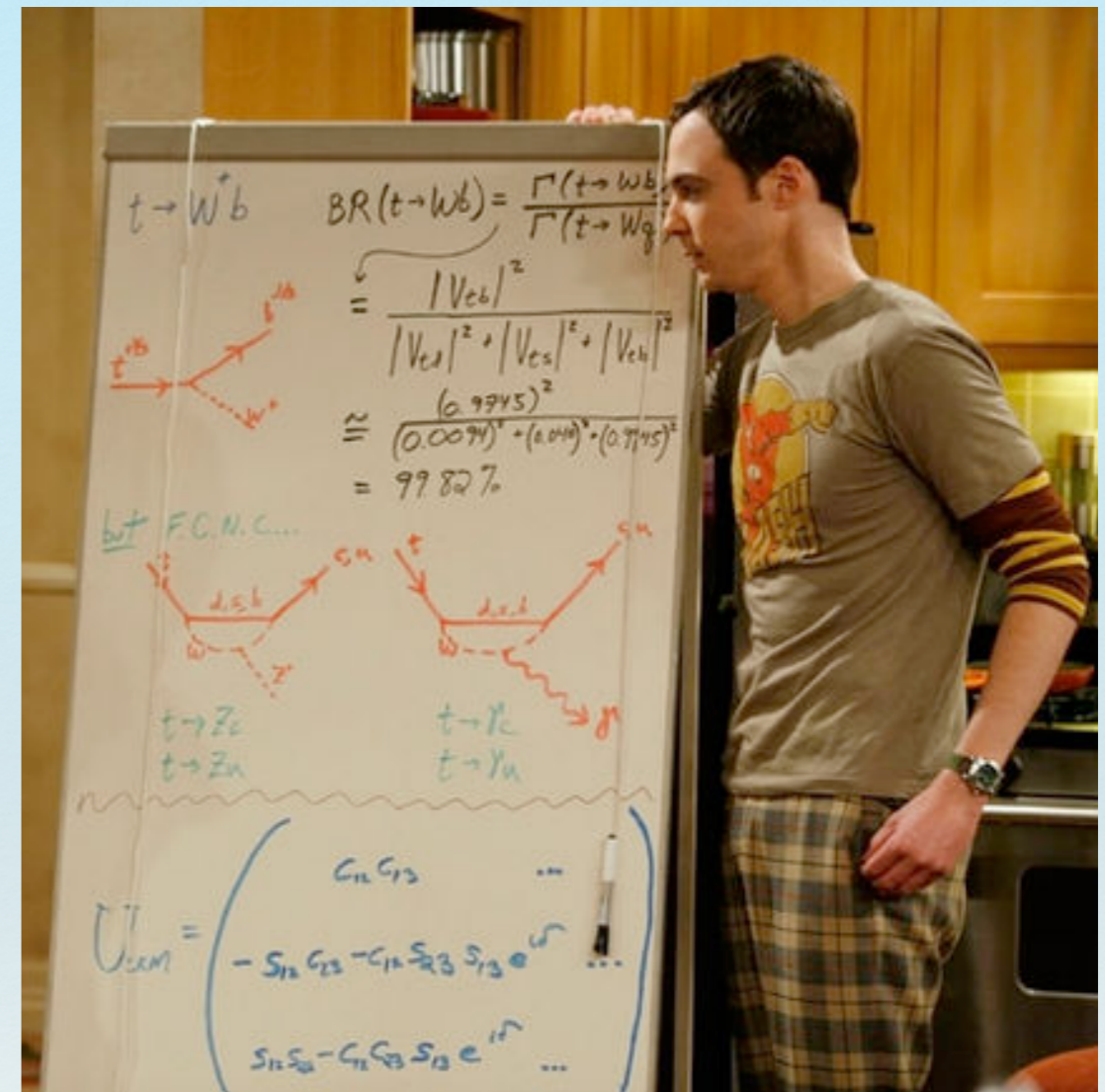

# Strangeness (1)

- ❖ 1946-1949: discovery of strange V-tracks in Wilson cloud chambers detecting cosmic rays. Interpretation: invisible neutral particles (called  $V^0$ ) decay to 2 opposite charge particles and detected charged particles (called  $V^+$  and  $V^-$ ) decay to 1 charged and 1 invisible neutral particles.

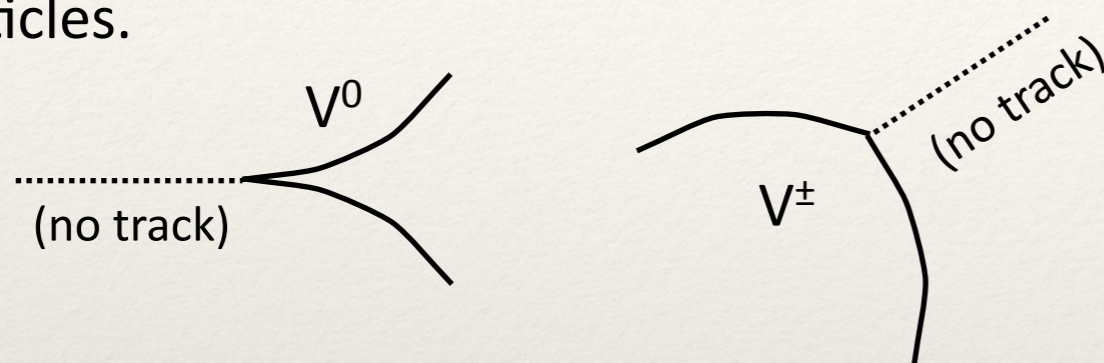

Observation of many such unknown particles, with masses heavier than  $\pi$  mass and lifetimes  $\sim 10^{-9}$  s.

- ❖ Discovery of a new particle in 1949 called  $K^0$  (quarks not yet discovered), with  $m \sim 495$  MeV.
- ❖ 1953:  $V^0$  and  $V^\pm$  particles were given names:  $\Lambda^0$ ,  $\Lambda^+$ ,  $\Lambda^-$ ,  $K^0_1$ ,  $K^0_2$ ,  $\Sigma^+$ ,  $\Sigma^-$ ,  $\Xi^-$ , and classified according to their properties:
  - ❖ They are generally produced in pairs through strong interaction: e.g.,  $\pi^- p \rightarrow \Lambda^0 K^0 + X$ .
  - ❖ They decay through weak interaction in known particles: e.g.,  $\Lambda^0 \rightarrow p \pi^-$ ,  $K^0 \rightarrow \pi^+ \pi^-$ , ...

---

## Strangeness (2)

---

- ❖ In 1954 Gell-Man proposed a **new additive quantum number called Strangeness S** (quarks still not discovered yet):
  - ❖ conserved in strong and electromagnetic interactions,
  - ❖ violated in weak interaction.
- ❖ According to observed production and decay modes:
  - ❖  $S(\Lambda^0) = S(K^-) = S(\text{anti-}K^0) = -1$  because  $\Lambda^0$  and  $K^0$  are produced simultaneously,
  - ❖  $S(\Xi^-) = -2$ ,
  - ❖  $S(\text{particle}) = -S(\text{anti-particle})$ .
- ❖ **It was observed that  $\Delta S=1$  transitions are 20× less probable than those with  $\Delta S=0$ .**
- ❖ **Existence of u, d and s quarks** proposed by Gell-Mann and Zweig in 1963, observation in late 60s at SLAC.

# The Cabibbo mixing

- ❖ N. Cabibbo proposed in 1963 that **quarks involved in weak processes are not physics eigenstates**, in order to account for suppressed  $\Delta S = 1$  transitions w.r.t.  $\Delta S = 0$ :

$$d' = \cos\theta_c d + \sin\theta_c s$$

flavour eigenstate:  
involved in weak interactions

physics eigenstates:  
involved in electromagnetic  
and strong interactions

- ❖ Actual physics doublet becomes:  $\begin{pmatrix} u \\ d' \end{pmatrix}$

- ❖ **1 unique real parameter  $\theta_c \sim 13^\circ$**  is enough to describe the change of basis:

- ❖ Probability of  $\Delta S = 0$  transitions is proportional to  $\cos^2\theta_c \sim 1$ ,
- ❖ Probability of  $\Delta S = 1$  transitions is  $\sim \sin^2\theta_c \sim 0.05$  (20 times less).

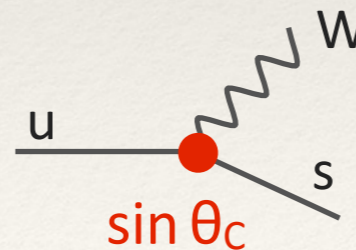
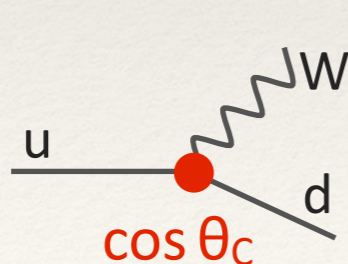

# Flavour Changing Neutral Currents

- ❖ cf. slide 18, Lagrangian term for Z-quark couplings implies terms  $\sim \psi\bar{\psi}$  (no impact from other terms, like  $(g_v - g_a \gamma_5)$  in the following discussion: hence they are not written).

with now  $\psi = \begin{pmatrix} u \\ d' \end{pmatrix} = \begin{pmatrix} u \\ \cos\theta_c d + \sin\theta_c s \end{pmatrix}$  we can write:

$$\psi\bar{\psi} = u\bar{u} + d'\bar{d}'$$

$$= u\bar{u} + (\cos\theta_c d + \sin\theta_c s)(\cos\theta_c \bar{d} + \sin\theta_c \bar{s})$$

$$= u\bar{u} + d\bar{d} \cos^2\theta_c + s\bar{s} \sin^2\theta_c + \boxed{(s\bar{d} + d\bar{s})} \cos\theta_c \sin\theta_c$$

would imply existence of FCNC  
**Flavour Changing Neutral Current**  
 → never observed

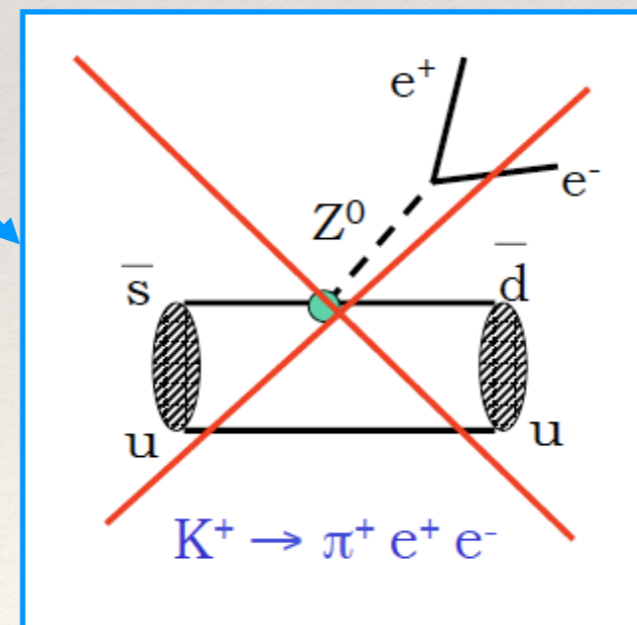

# The GIM mechanism

- ❖ In 1970, Glashow, Iliopoulos and Maiani proposed the existence of the **charm quark**, with charge  $+2/3e$ , to **get rid of possible FCNC transitions**.

The charm quark is coupled to the linear combination:  $s' = [ -\sin\theta_c d + \cos\theta_c s ]$

$$\begin{pmatrix} c \\ s' \end{pmatrix} = \begin{pmatrix} c \\ \cos\theta_c s - \sin\theta_c d \end{pmatrix}$$

→  $\psi\bar{\psi} = u\bar{u} + d\bar{d} + c\bar{c} + s\bar{s}$  no unwanted FCNC anymore

- ❖ Experimental observation of the  $J/\psi = (c\bar{c})$  in 1974 in  $e^+e^-$  collisions at SLAC and in a fixed target experiment at BNL.

Nobel prize allocated to Richter et Ting en 1976.

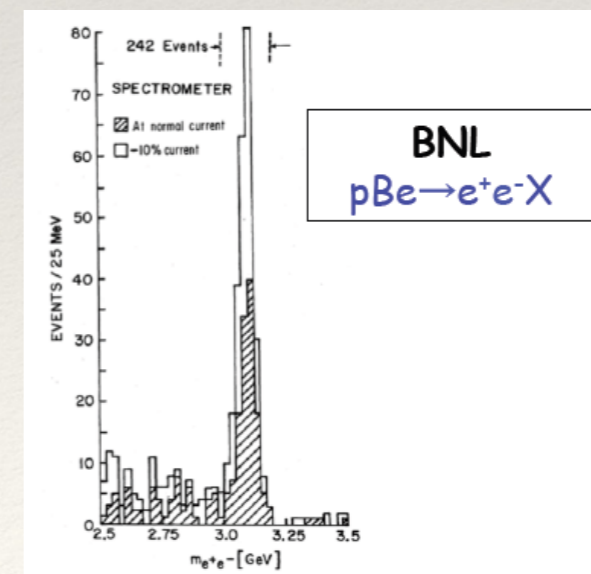
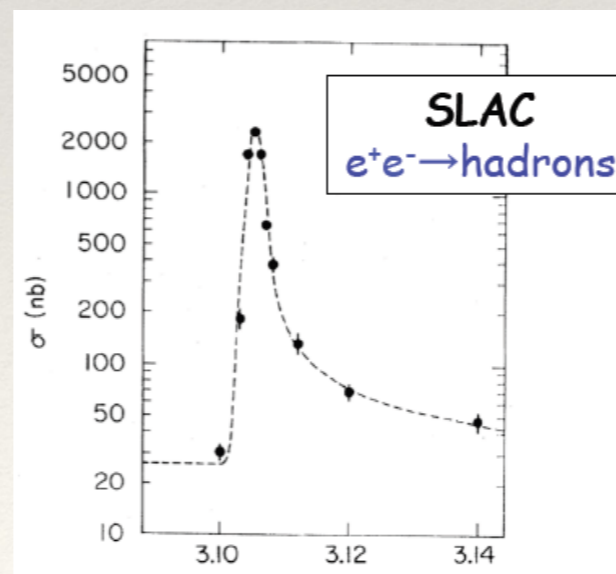

---

# Cabibbo mixing

---

- ❖ Conclusion: quark physics states (used to write the Hamiltonian) are different from flavour states, seen by weak interaction.

One quark basis is transformed to the other one with a 2×2 unitary matrix V:

$$\begin{pmatrix} d' \\ s' \end{pmatrix}_{\text{weak}} = V \begin{pmatrix} d \\ s \end{pmatrix}_{\text{mass}}$$

- ❖ The Cabibbo V matrix can be fully described by only one parameter  $\theta_c$ :

$$V = \begin{pmatrix} \cos\theta_c & \sin\theta_c \\ -\sin\theta_c & \cos\theta_c \end{pmatrix}$$

# The CKM matrix (1)

- ❖ In 1973, Kobayashi and Maskawa proposed to introduce a **3<sup>rd</sup> doublet of quarks** to account for **CP violation in weak interactions** (observed in  $K_L^0 \rightarrow \pi\pi$  decays by Christenson, Cronin, Fitch and Turlay in 1964, Nobel prize in 1980).

→ 3  $SU(2)_L$  doublets:  $\begin{pmatrix} u \\ d' \end{pmatrix}_L$   $\begin{pmatrix} c \\ s' \end{pmatrix}_L$   $\begin{pmatrix} t \\ b' \end{pmatrix}_L$

- ❖ Discovery of  $Y = (b\bar{b})$  in 1977 in a fixed experiment at FNAL, and of the top quark in  $p\bar{p}$  collisions in 1995 at FNAL.

- ❖ CKM matrix = **generalisation of the Cabibbo mixing with 3  $SU(2)$  doublets of quarks:**

$$\begin{pmatrix} d' \\ s' \\ b' \end{pmatrix}_{\text{weak}} = \begin{pmatrix} V_{ud} & V_{us} & V_{ub} \\ V_{cd} & V_{cs} & V_{cb} \\ V_{td} & V_{ts} & V_{tb} \end{pmatrix} \begin{pmatrix} d \\ s \\ b \end{pmatrix}_{\text{mass}}$$

→ description of flavour changing through charged weak interaction:

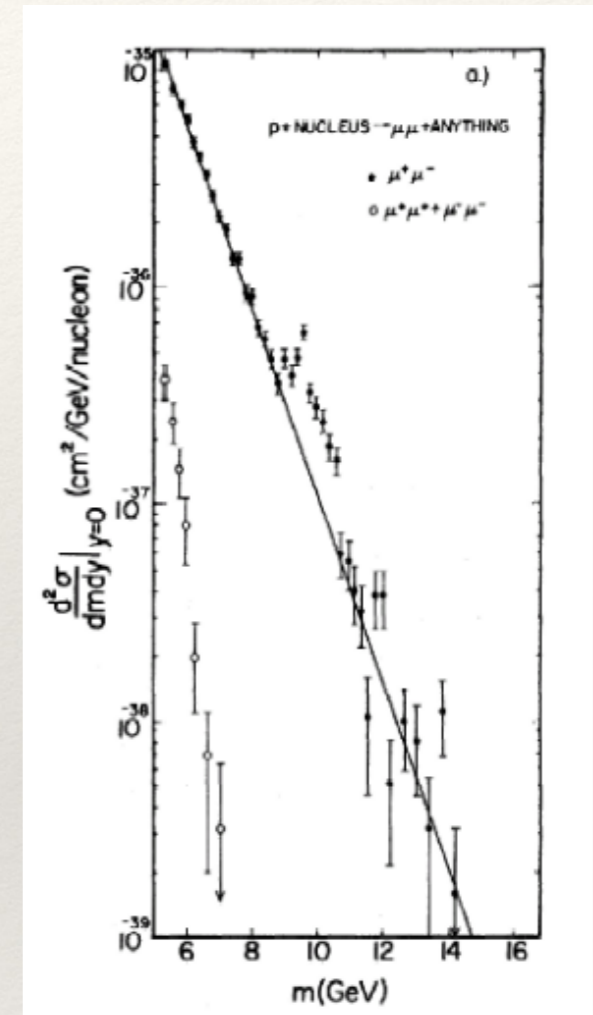
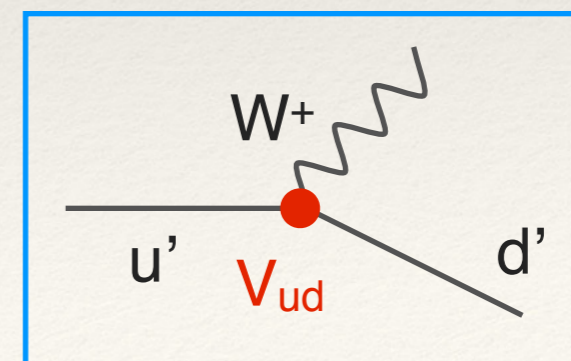



## The CKM matrix (2)

- ❖ The CKM matrix is **complex of dim 3×3**
  - ➔ 9 elements  $|V_{ij}| \exp(-i\varphi_{ij})$ , described by 18 parameters:
    - ❖ the **unitarity relation  $V V^\dagger = Id$**  implies  $3^2$  relations between the matrix elements;
    - ❖ **5 relative phases among the quarks** out of 6 can be redefined w/o changing the Lagrangien.
  - ➔ only **4 parameters remain independent: 3 rotation angles + 1 CP-violating phase.**  
These parameters are usually called:  $A, \lambda, \rho$  and  $\eta$ .  
One and only one phase.
- ❖ Comment: with 2 families of quarks only (Cabibbo mixing), there is no CP-violating phase.  
Kobayashi and Maskawa understood that **CPV can only be generated with  $\geq 3$  families.**

# The CKM matrix (3)

- ❖ Experimental observation of a hierarchy between the 9 modules of the matrix elements:

$$V_{\text{CKM}} = \begin{pmatrix} 0.97434^{+0.00011}_{-0.00012} & 0.22506 \pm 0.00050 & 0.00357 \pm 0.00015 \\ 0.22492 \pm 0.00050 & 0.97351 \pm 0.00013 & 0.0411 \pm 0.0013 \\ 0.00875^{+0.00032}_{-0.00033} & 0.0403 \pm 0.0013 & 0.99915 \pm 0.00005 \end{pmatrix}$$

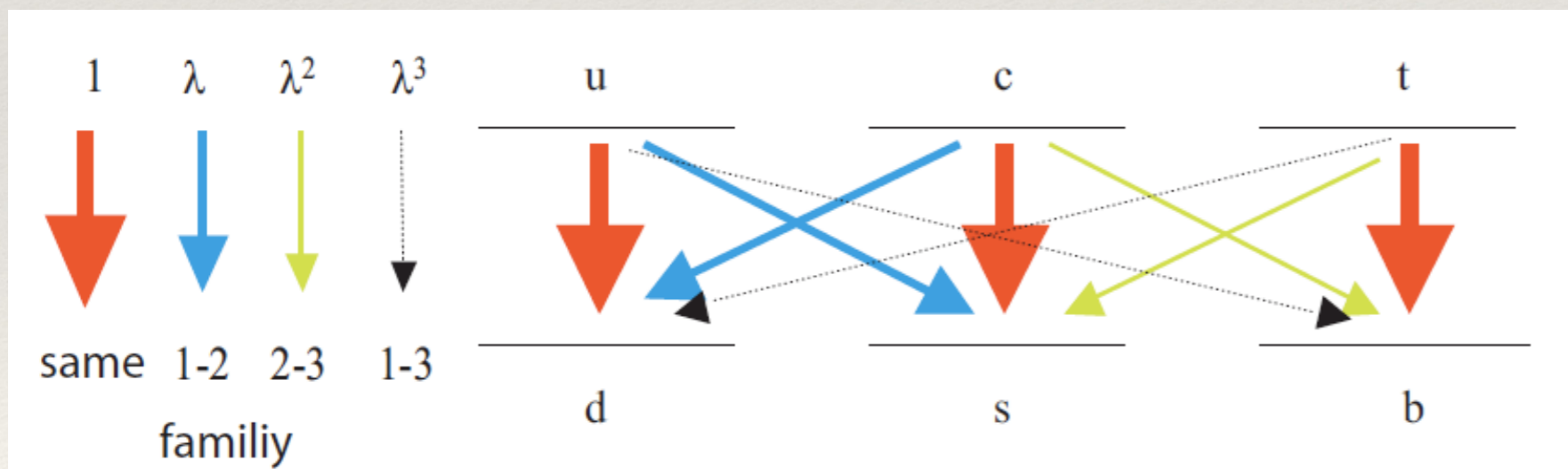
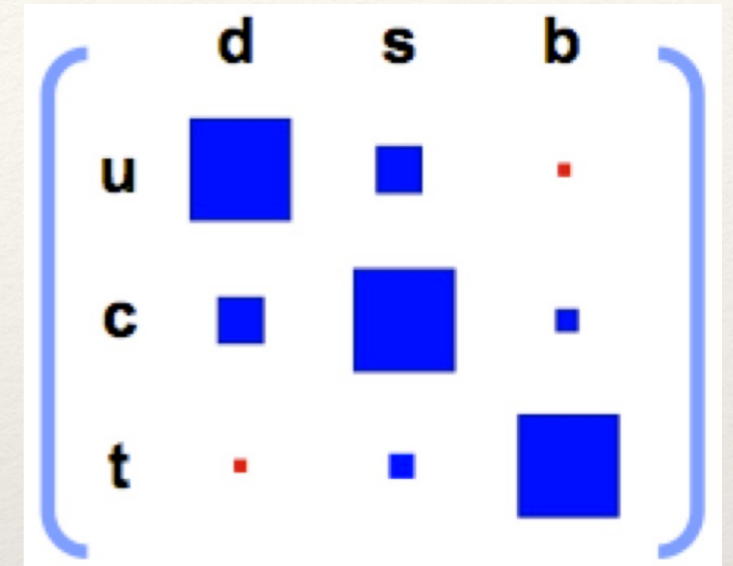

$$V \approx \begin{pmatrix} 1 & \lambda & \lambda^3 \\ \lambda & 1 & \lambda^2 \\ \lambda^3 & \lambda^2 & 1 \end{pmatrix}$$

with  $\lambda = \sin \theta_c \sim 0.22$

# The Wolfenstein parametrisation

- ❖ Wolfenstein (phenomenological) parametrisation of the CKM matrix with  $A$ ,  $\lambda$ ,  $\rho$  and  $\eta$  parameters, to account for the observed hierarchy between element modules.
- ❖ Expansion up to  $\lambda^3$  to handle Belle / BaBar measurements (mainly CP violation measurements):

$$V_{CKM} = \begin{pmatrix} 1 - \frac{\lambda^2}{2} & \lambda & A\lambda^3(\rho - i\eta) \\ -\lambda & 1 - \frac{\lambda^2}{2} & A\lambda^2 \\ A\lambda^3(1 - \rho - i\eta) & -A\lambda^2 & 1 \end{pmatrix} + \mathcal{O}(\lambda^4).$$

- ❖ Expansion up to order  $\lambda^5$  needed to compare to more precise LHCb and Belle II measurements and search for beyond standard model physics:

$$V_{CKM} = \begin{pmatrix} 1 - \frac{\lambda^2}{2} - \frac{\lambda^4}{8} & \lambda & A\lambda^3(\rho - i\eta) \\ -\lambda + \frac{A^2\lambda^5}{2}(1 - 2\rho) - iA^2\lambda^5\eta & 1 - \frac{\lambda^2}{2} - \lambda^4\left(\frac{1}{8} + \frac{A^2}{2}\right) & A\lambda^2 \\ A\lambda^3 \left[1 - \left(1 - \frac{\lambda^2}{2}\right)(\rho + i\eta)\right] & -A\lambda^2\left(1 - \frac{\lambda^2}{2}\right) [1 + \lambda^2(\rho + i\eta)] & 1 - \frac{A^2\lambda^4}{2} \end{pmatrix} + \mathcal{O}(\lambda^6).$$

Simplification of the notation:  $V_{td} = A\lambda^3 (1 - \bar{\rho} - i\bar{\eta})$

with:  $\bar{\rho} = \rho(1 - \lambda^2/2)$  et  $\bar{\eta} = \eta(1 - \lambda^2/2)$

# Unitarity triangles (1)

- There are 6 non diagonal unitarity relations of the CKM matrix:

s-d	$V_{ud}^* V_{us} + V_{cd}^* V_{cs} + V_{td}^* V_{ts} = 0$	$\lambda \lambda \lambda^5$
b-d	$V_{ub}^* V_{ud} + V_{cb}^* V_{cd} + V_{tb}^* V_{td} = 0$	$\lambda^3 \lambda^3 \lambda^3$
b-s	$V_{us}^* V_{ub} + V_{cs}^* V_{cb} + V_{ts}^* V_{tb} = 0$	$\lambda^4 \lambda^2 \lambda^2$
t-u	$V_{ud}^* V_{td} + V_{us}^* V_{ts} + V_{ub}^* V_{tb} = 0$	$\lambda^3 \lambda^3 \lambda^3$
t-c	$V_{td}^* V_{cd} + V_{ts}^* V_{cs} + V_{tb}^* V_{cb} = 0$	$\lambda^4 \lambda^2 \lambda^2$
c-u	$V_{ud}^* V_{cd} + V_{us}^* V_{cs} + V_{ub}^* V_{cb} = 0$	$\lambda \lambda \lambda^5$

- These 6 relations can be represented graphically by a triangle in the complex  $(\bar{\rho}, \bar{\eta})$  plane:

- Triangle surface = 0  $\Leftrightarrow$  CPV = 0.

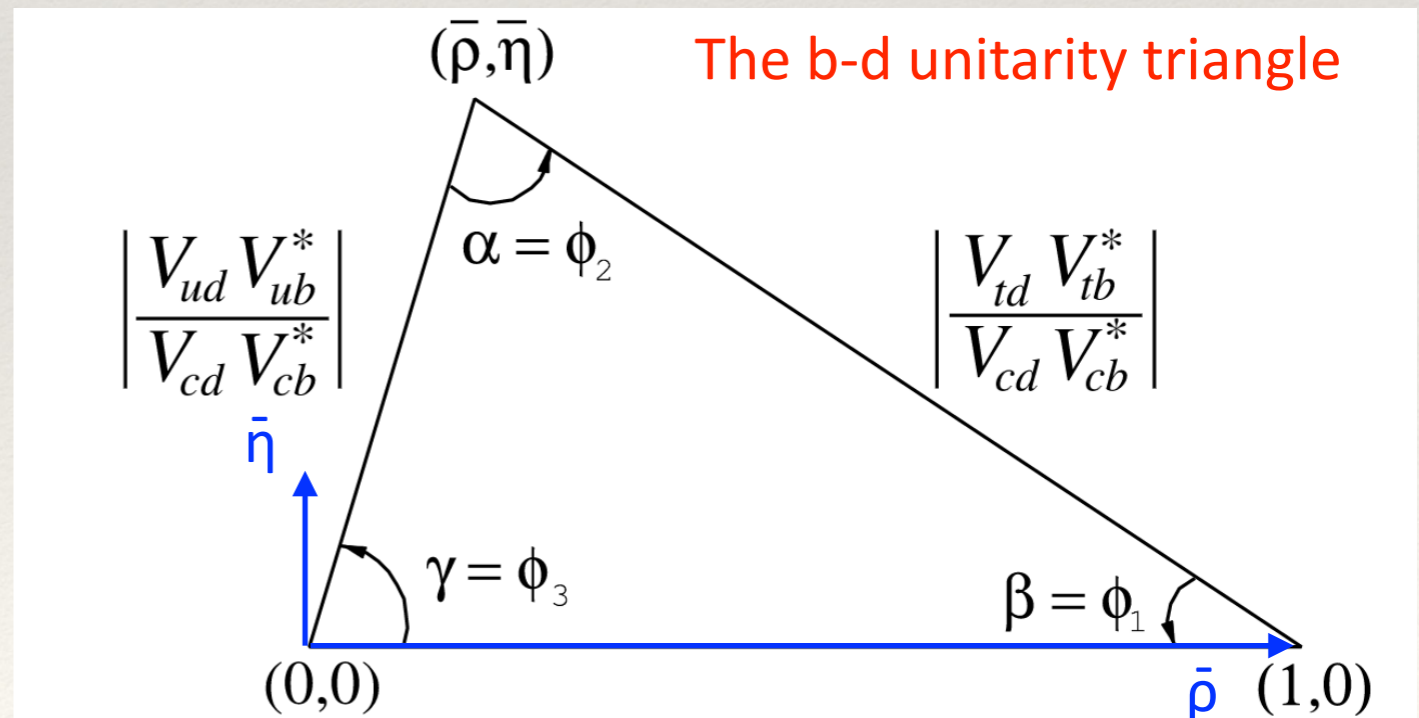

## Unitarity triangles (2)

- ❖ Measurement of the b-d UT leads to the complete determination of the CKM matrix (the 4 parameter values can be estimated if the UT is reconstructed).  
To search for physics beyond the SM:
  - ❖ **Redundant measurements of all 6 triangles** (most of them are  $\sim$  flat: less easy to measure than the b-d UT):  
coherence w.r.t. SM predictions, only 1 phase.  
→ **all 6 triangles feature the same area in the SM.**
  - ❖ **Compare tree with higher order processes** (sensitive to unknown particles contributions).

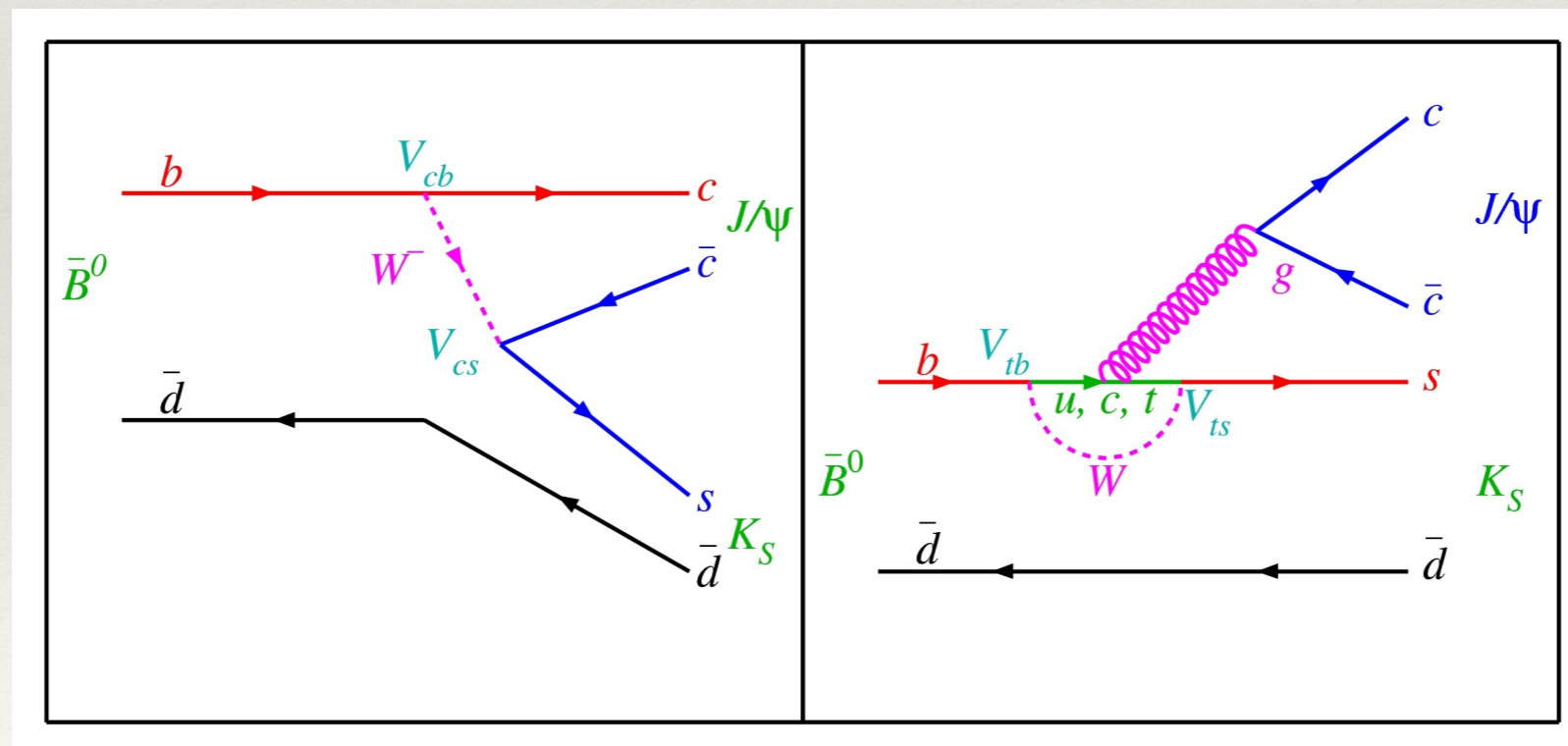

# Unitarity triangles (3)

constraints on the b-d unitarity triangle from:

tree-level amplitudes,  
i.e. Flavour Changing Charged Currents

loop-mediated amplitudes,  
i.e.  $\Delta F=2$  Flavour Changing Neutral Currents

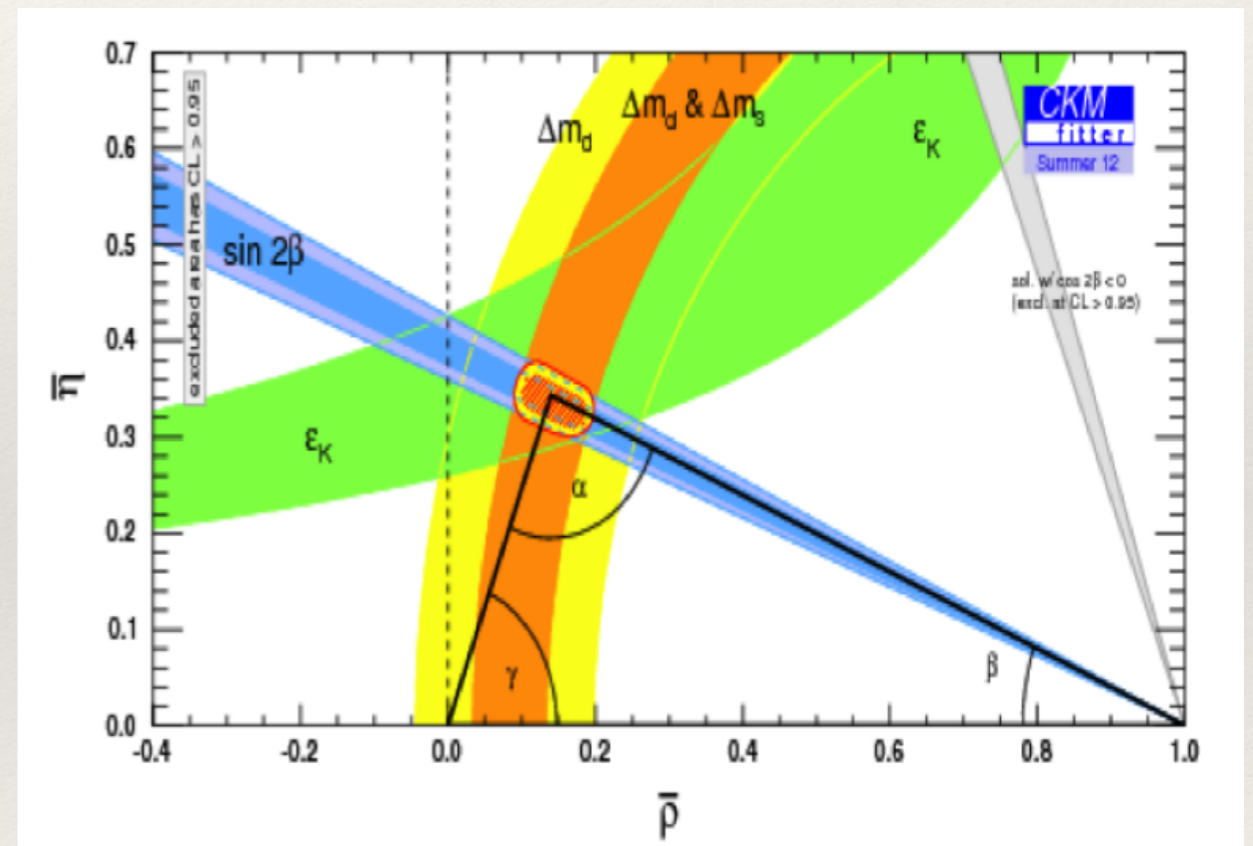
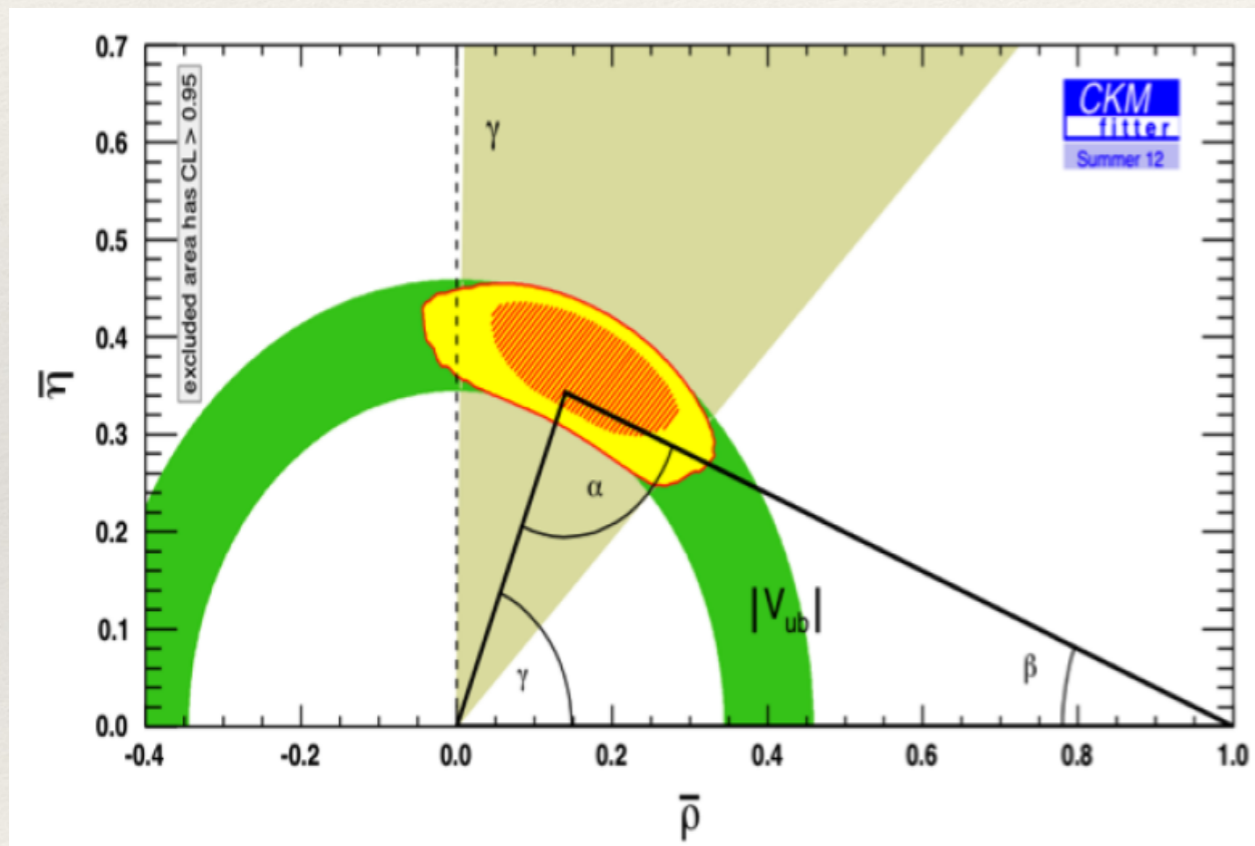

[<http://ckmfitter.in2p3.fr>]

Currently, all measurements are in agreement with the SM relations.

# Course outline

- ❖ Introduction to the standard model
- ❖ The CKM formalism
- ❖ **Beyond the SM**
- ❖ Effective Lagrangian of physics beyond the standard model

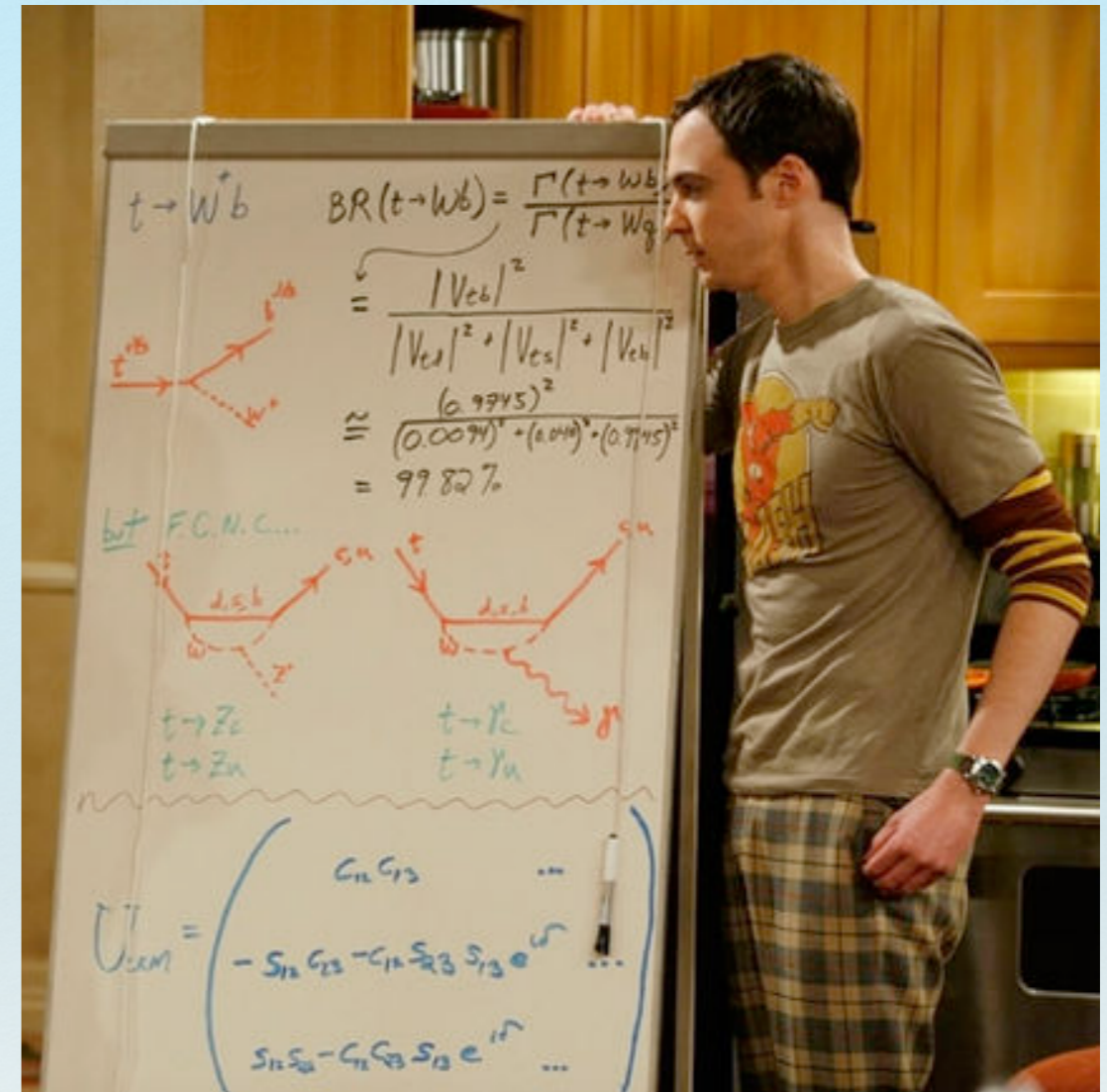

# Success of the SM (1)

- ❖ Predictions of the SM have been observed: vector bosons,  $\tau$  charged lepton,  $\tau$  neutrino, bottom, charm and top quarks, Higgs boson.
- ❖ All measurements agree with their prediction with an unprecedented precision. Coherence of the SM.
  - demonstration of the quantum nature of particles.

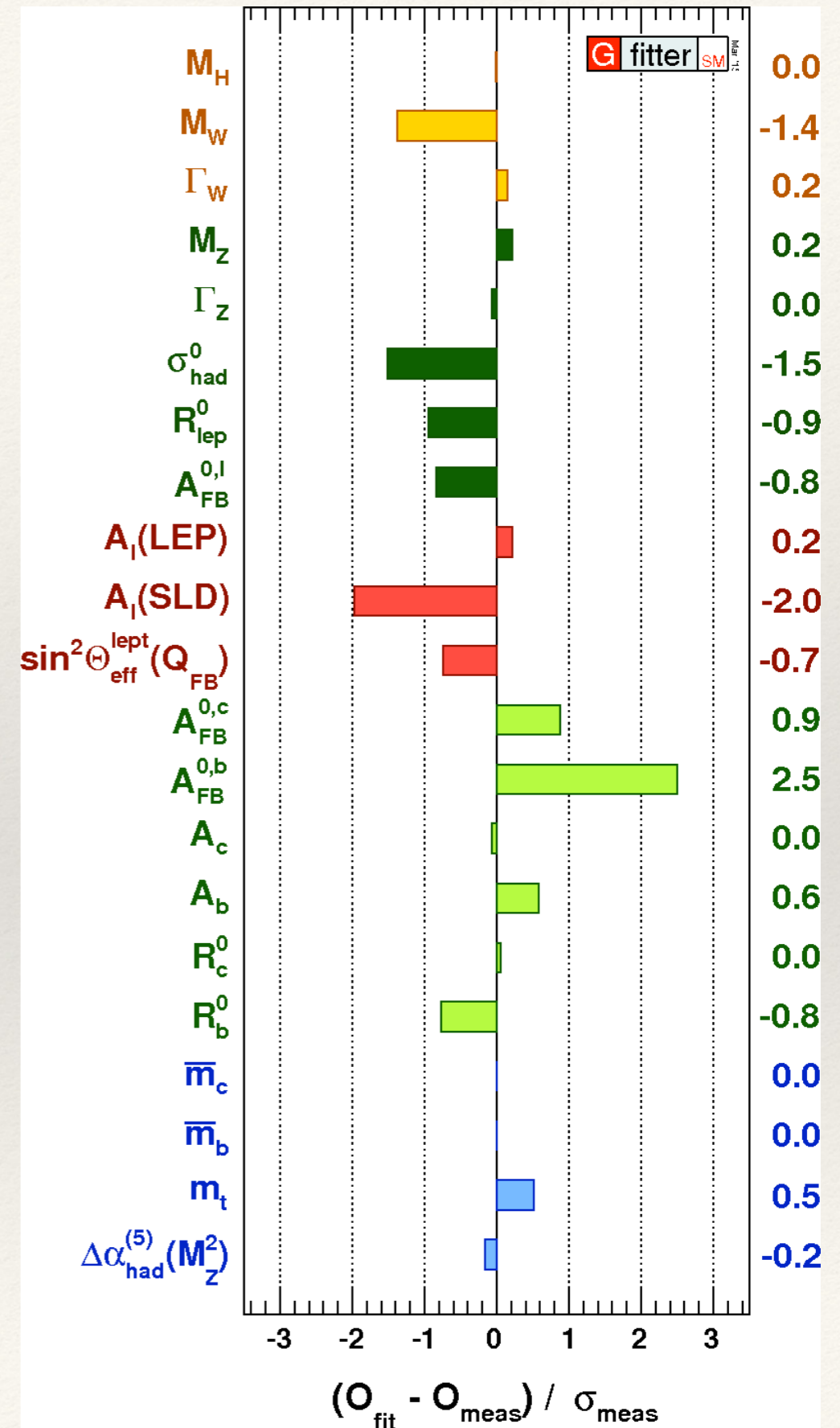



## Success of the SM (2)

- ❖ Many Nobel prizes were given for related theoretical, instrumental and experimental works:
  - 1979: Glashow, Salam and Weinberg - electroweak theory,
  - 1980: Cronin and Fitch - CP violating K meson decays,
  - 1984: Rubbia and Van der Meer - discovery of W and Z bosons with the SpS accelerator,
  - 1988: Lederman, Schwartz and Steinberger - discovery of  $\nu_\mu$ ,
  - 1990: Friedman, Kendall and Taylor - partons discovery in a DIS ep experiment,
  - 1995: Perl and Reines - detection of  $\nu$  and discovery of  $\tau$  leptons,
  - 1999: 't Hooft and Veltman - demonstration that SM is a renormalisable theory,
  - 2004: Gross, Politzer and Wilzcek - strong interaction theory,
  - 2008: Kobayashi and Maskawa - origin of CP violation in the SM,
  - 2013: Englert and Higgs - existence of the Higgs boson.
- ❖ But also... 2015: Kajita and McDonald  
observation of neutrino oscillations
  - ➔ **neutrinos are massive particles!**  
**This is not described correctly in the SM!**



# Limitation of the SM

- ❖ Several observations are not described in the SM, e.g.:
  - ❖ The **matter-antimatter asymmetry** induced in the SM is much lower than what is observed in the universe, i.e. total disappearance of the antimatter.
  - ❖ 85 % of the gravitational mass in the universe is actually unseen and called **Dark matter**.
  - ❖ Nature of dark matter is unknown (one part is not baryonic) and not described by the SM.
  - ❖ 70 % of the energy density of the universe is of unknown nature, hence it is called **Dark Energy** and it is not described by the SM.
  - ❖ The SM describes **massless neutrinos**.
- ❖ The SM is not valid at very high energies (Planck scale  $\sim 10^{19}$  GeV):
  - ❖ How to include **gravitation** in the theory?
- ❖ We still do not know:
  - ❖ Why **3 fermion families**?
  - ❖ Where does the **Higgs** potential come from?
  - ❖ Where do the values of SM **free parameters** come from?
  - ❖ Why is the **electric charge** quantified ?
  - ❖ etc.

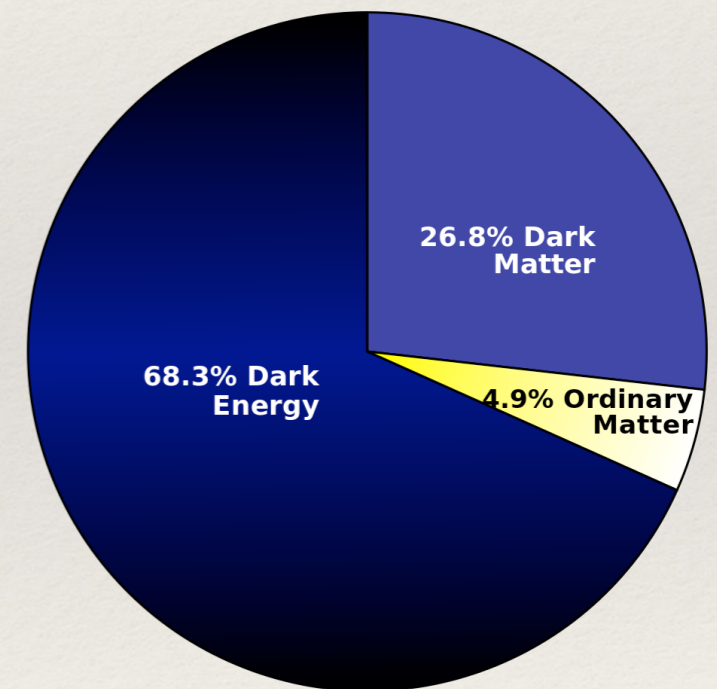

Known physics corresponds only to 5% of the universe.

# Baryon/anti-baryon asymmetry

- ❖ Observed baryon/anti-baryon asymmetry in the universe today:  $\Delta n_B / n_\gamma \sim 6 \times 10^{-10}$ 

The early universe is expected to be symmetric (i.e.  $\Delta n_B = 0$ ), then an imbalance between matter and anti-matter is produced, satisfying Sakharov conditions.
- ❖ Sakharov conditions (1967):
  - 1) Baryon number violation:
    - ➔ possible in the SM with sphalerons and violation of B and L, but B-L is conserved.  
Baryons are transformed in anti-leptons and vice-versa.
  - 2) C and CP symmetries violation:
    - ➔ at least one more CP violating phase is needed in addition to the CKM one.  
SM with one unique CPV phase allows:  $\Delta n_B / n_\gamma \approx 10^{-18}$ .
  - 3) Interactions out of thermal equilibrium:
    - ➔ baryogenesis within the SM requires electroweak symmetry breaking be a first-order phase transition.  
Constrains  $M_H \sim < 40 \text{ GeV}/c^2$ , or requires an extended scalar sector (introducing new CPV phases).

# Flavour changing

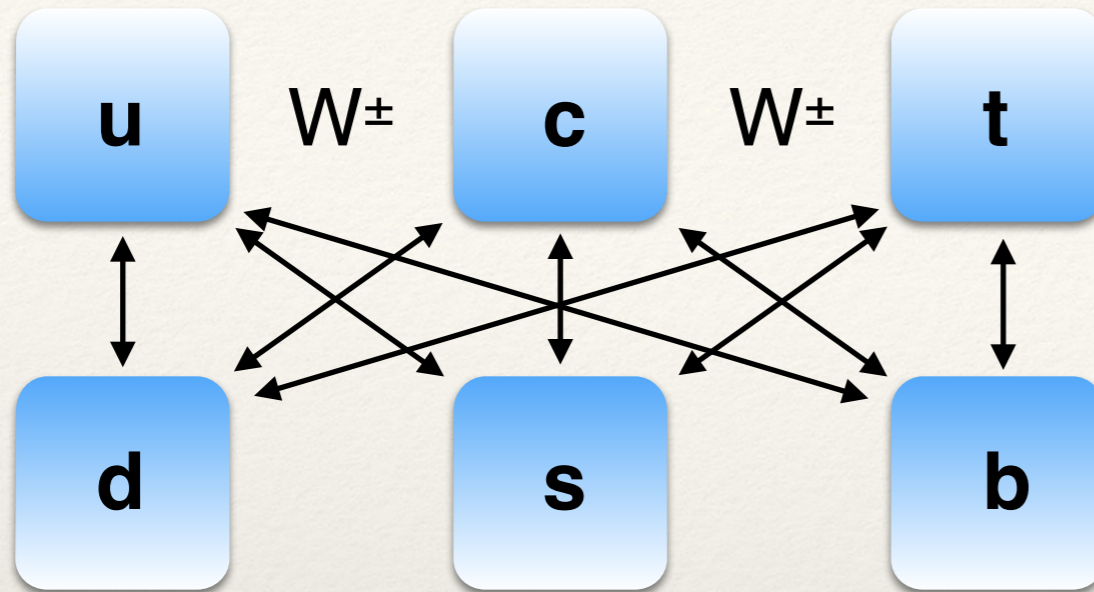

“who ordered that?”

by I. Rabbi  
according to

[Phys.Rept. 532 (2013) 27-64]

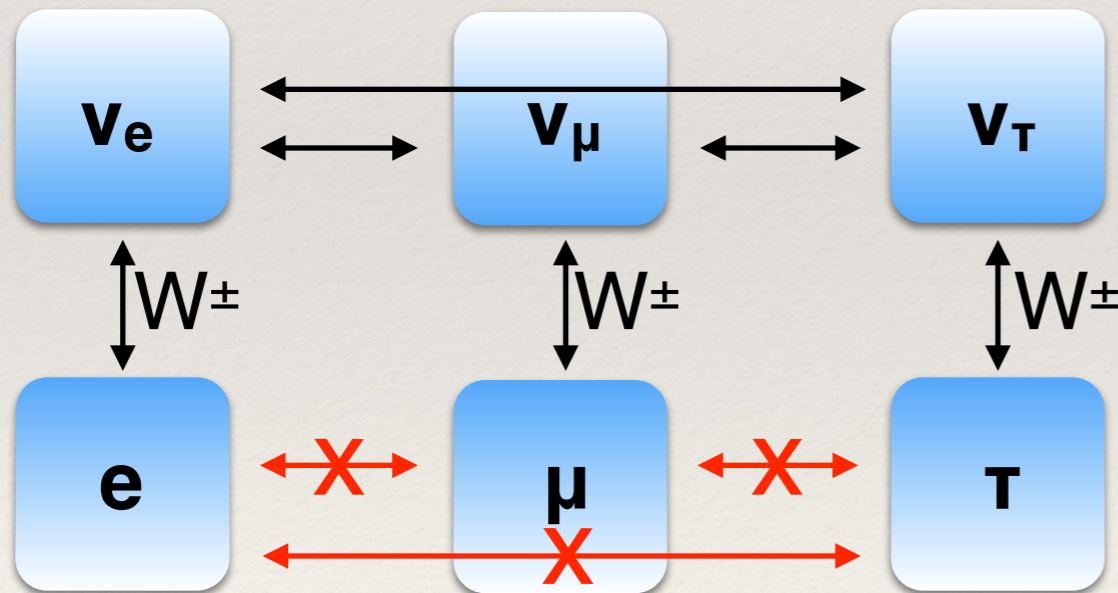

?

# Quarks and leptons

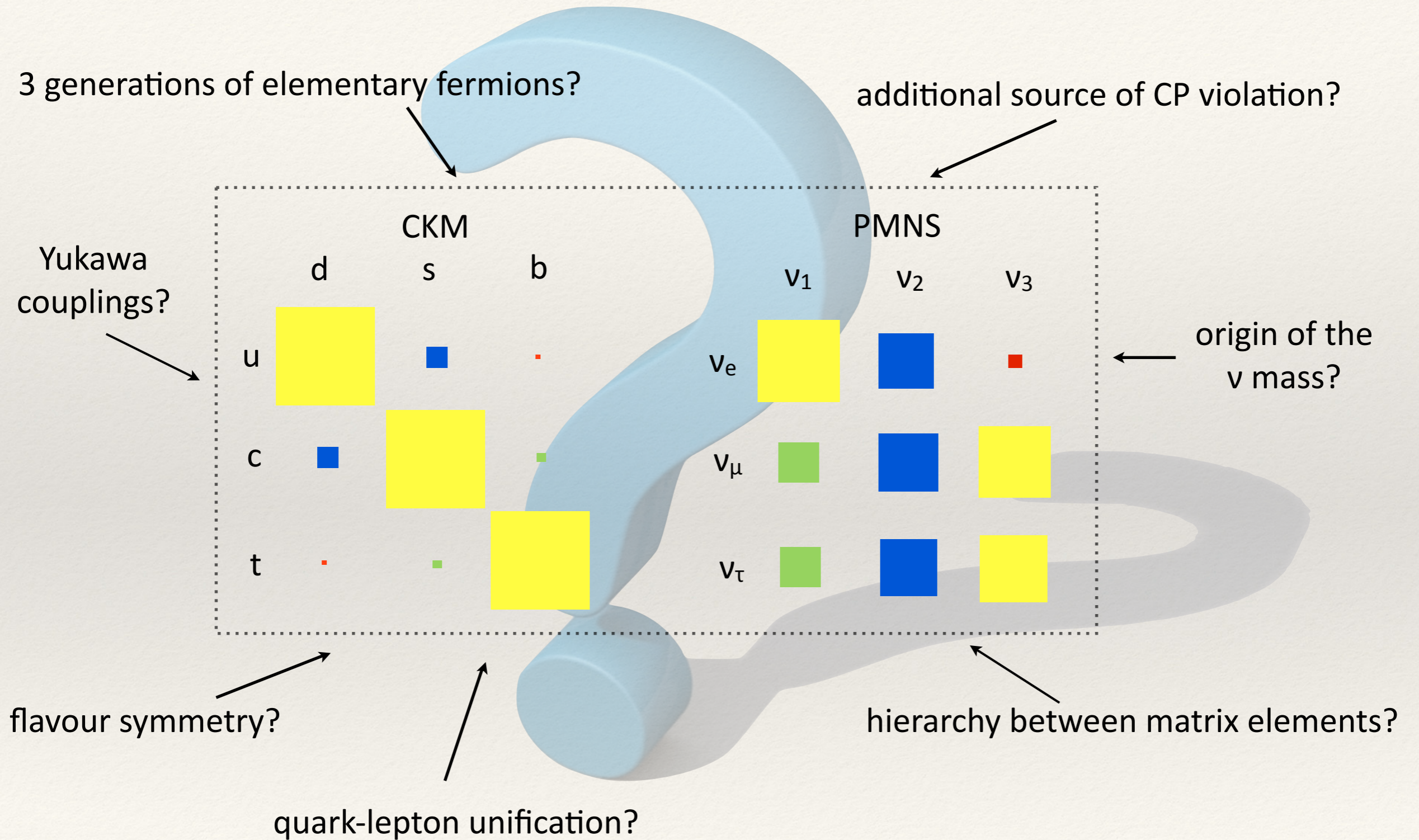

# SM as an effective theory

- ❖ Conclusion: we need to extend the SM, which is only an **effective theory**:
  - ❖ What is the nature of physics beyond the SM: strings vs. particles, compositeness, extra-dimensions, what symmetries govern the physics laws?
  - ❖ **At what energy** do we need to overcome the SM? Is it within current experimental reach?

- ❖ **Very different situation w.r.t. the past: only few indications from observation** to extend the theory.

Besides already discussed observations (lepton flavour violation, dark matter, CP violation, etc.), few puzzling  $\sim 3\sigma$  smoking guns from precision measurements:

- ❖ muon  $g-2$ ,
- ❖  $\sin^2\theta_w$ ,
- ❖  $B \rightarrow D^{(*)}\tau\nu$ ,
- ❖ angular  $B^0 \rightarrow K^{0*}\mu\mu$  distribution,
- ❖ ...

➔ often based on one **unique, statistically limited** and finally **non conclusive measurement**.

➔ some of these measurements will be presented in this school.



*“This could be the discovery of the century. Depending, of course, on how far down it goes.”*

# Going beyond the SM?

## New proposed theories:

- Grand Unification Theories
- Supersymmetries
- Superstrings
- Extra space dimensions
- Technicolor
- Compositeness
- etc.



experimental  
evidences

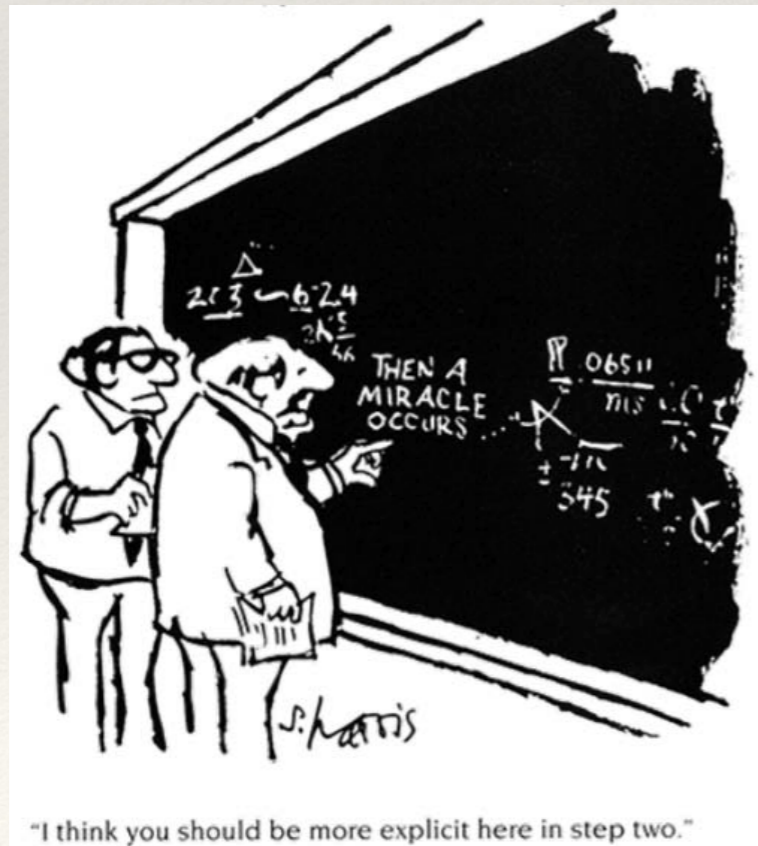

**New directions to overcome the SM will be given by experimental observations ( ← launched by new tools).**

# Quantum and relativistic paths (1)

- ❖ Observed manifestations of Beyond SM physics **do not indicate any energy scale.**
- ❖ Finding and understanding new physics will not be easy!  
→ pursue a global effort relying on different programs:

- ❖ **The quantum path:** reach an unprecedented precision, both on experimental measurements and their theoretical predictions, and **be sensitive to quantum manifestations of new unknown particles.**

Need a very high statistics, hence high luminosities and/or process cross-sections: the **intensity frontier**.

Examples of experiments: LHCb (high  $b\bar{b}$  cross-section), Belle II (high luminosity of SuperKEKB), muon experiments (intense beams).

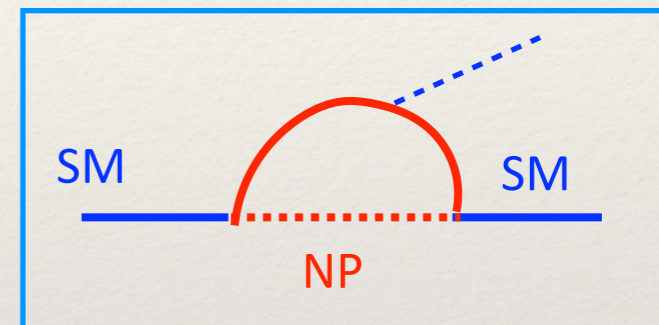

- ❖ **The relativistic path:** reach the highest possible collision energy, to **produce real new unknown particles on their mass shell:** the **energy frontier**.

Examples of experiments: ATLAS and CMS at LHC.

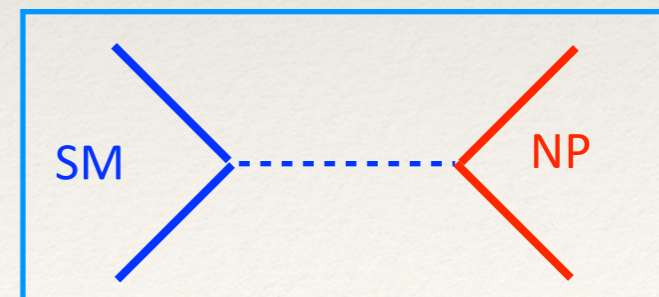



# Quantum and relativistic paths (2)

- ❖ In the past HEP history, quantum corrections and Flavour Changing processes enabled key progresses: existence of the charm quark, of the 3<sup>rd</sup> quark family, top mass, Higgs mass, ...

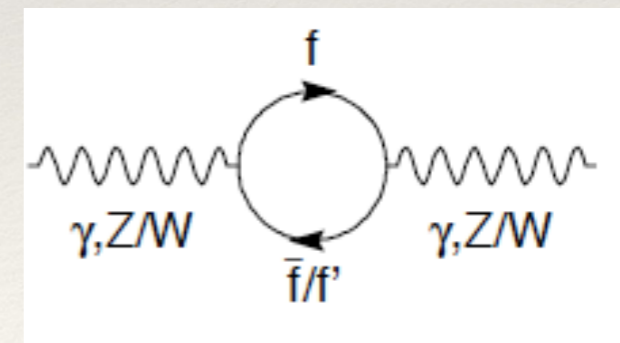
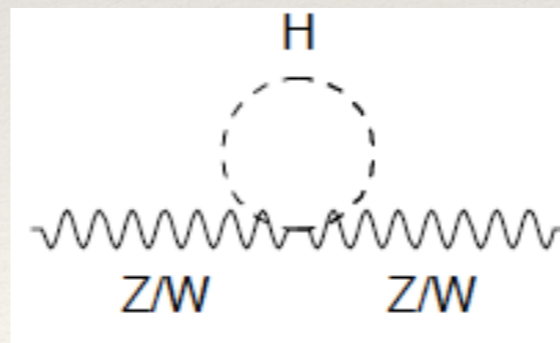
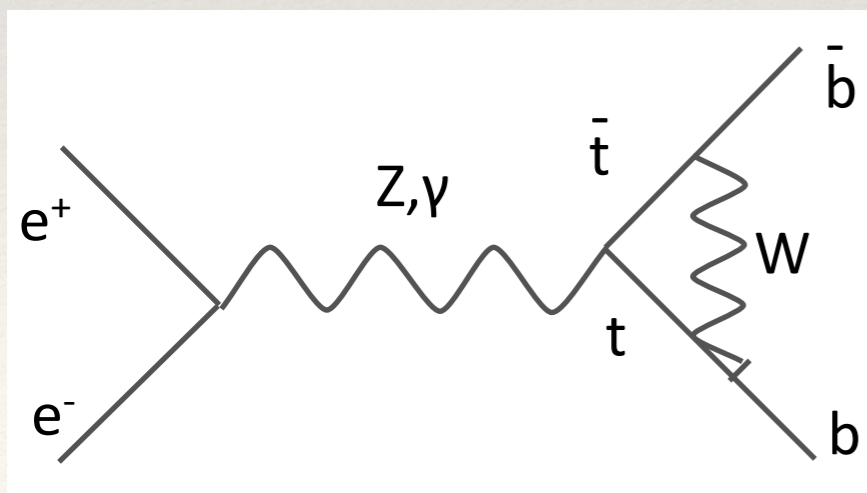
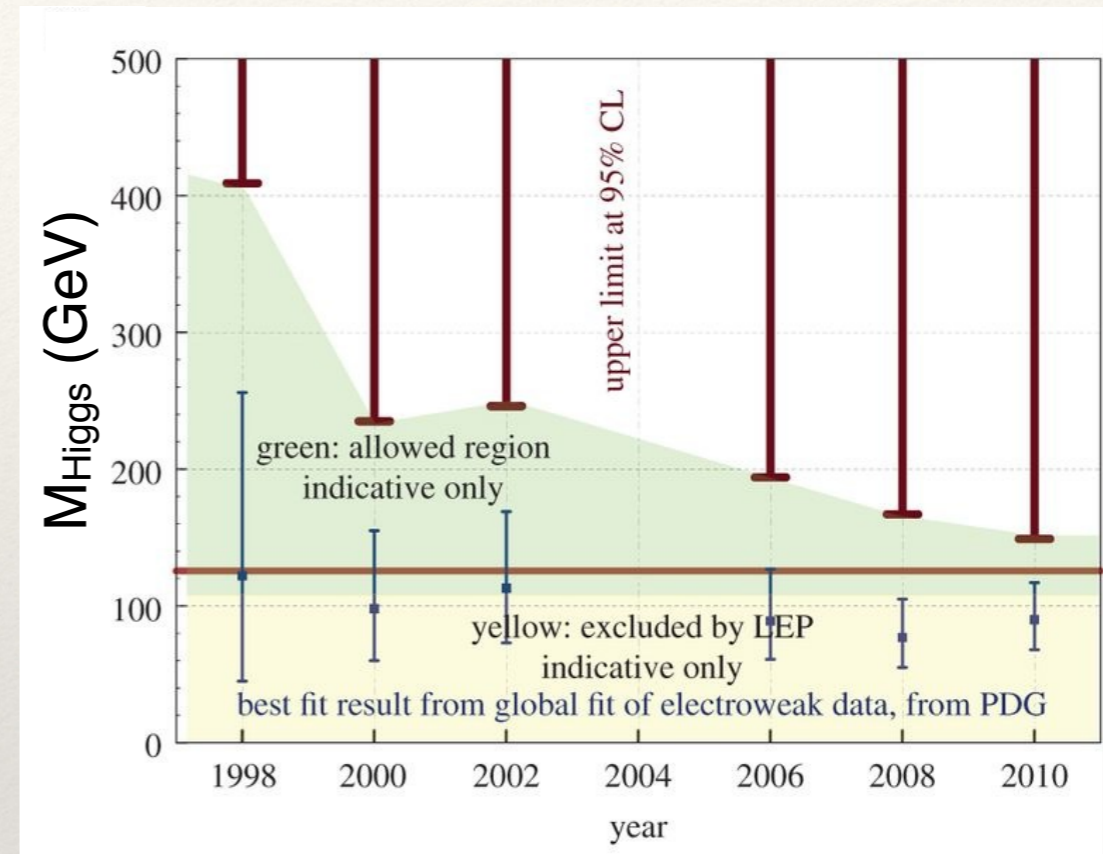
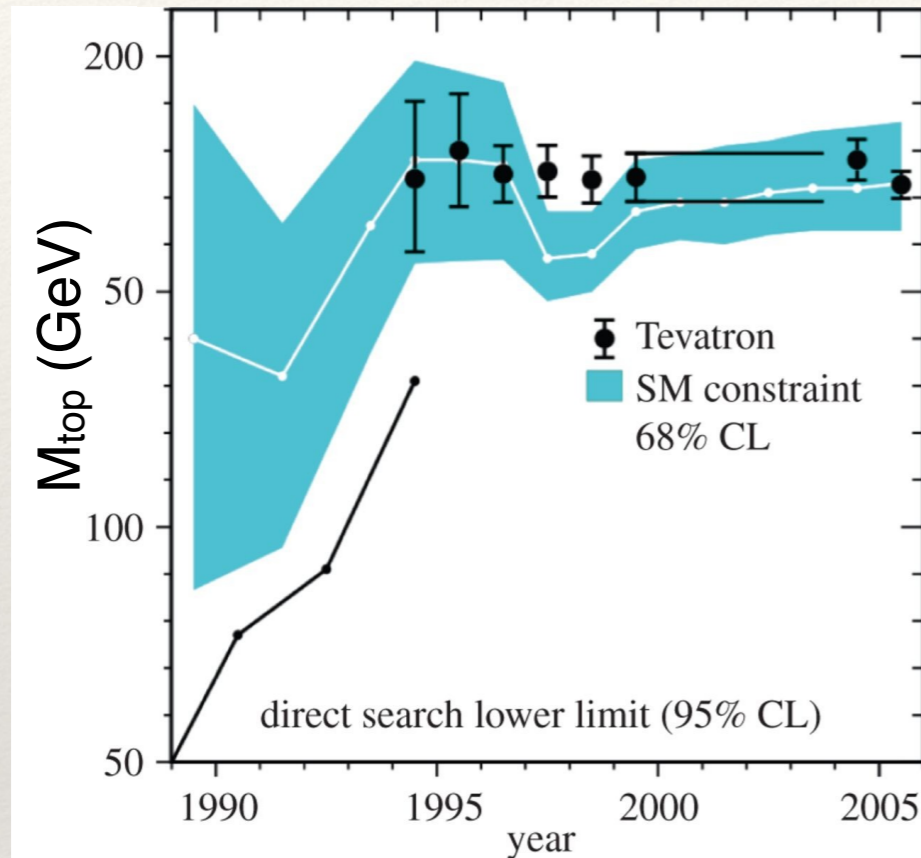

# Quantum and relativistic paths (3)

- Look for BSM physics by measuring lots of observables with good sensitivity to NP, depending on the BSM theory.

DNA of flavour physics effects on BSM theories

	AC	RVV2	AKM	$\delta$ LL	FBMSSM	LHT	RS
$D^0 - \bar{D}^0$	★★★★	★	★	★	★	★★★★	?
$\epsilon_K$	★	★★★★	★★★★	★	★	★★	★★★★
$S_{\psi\phi}$	★★★★	★★★★	★★★★	★	★	★★★★	★★★★
$S_{\phi K_S}$	★★★★	★★	★	★★★★	★★★★	★	?
$A_{CP}(B \rightarrow X_s \gamma)$	★	★	★	★★★★	★★★★	★	?
$A_{7,8}(B \rightarrow K^* \mu^+ \mu^-)$	★	★	★	★★★★	★★★★	★★	?
$A_9(B \rightarrow K^* \mu^+ \mu^-)$	★	★	★	★	★	★	?
$B \rightarrow K^{(*)} \nu \bar{\nu}$	★	★	★	★	★	★	★
$B_s \rightarrow \mu^+ \mu^-$	★★★★	★★★★	★★★★	★★★★	★★★★	★	★
$K^+ \rightarrow \pi^+ \nu \bar{\nu}$	★	★	★	★	★	★★★★	★★★★
$K_L \rightarrow \pi^0 \nu \bar{\nu}$	★	★	★	★	★	★★★★	★★★★
$\mu \rightarrow e \gamma$	★★★★	★★★★	★★★★	★★★★	★★★★	★★★★	★★★★
$\tau \rightarrow \mu \gamma$	★★★★	★★★★	★	★★★★	★★★★	★★★★	★★★★
$\mu + N \rightarrow e + N$	★★★★	★★★★	★★★★	★★★★	★★★★	★★★★	★★★★
$d_n$	★★★★	★★★★	★★★★	★★	★★★★	★	★★★★
$d_e$	★★★★	★★★★	★★	★	★★★★	★	★★★★
$(g-2)_\mu$	★★★★	★★★★	★★	★★★★	★★★★	★	?

Table 8: “DNA” of flavour physics effects for the most interesting observables in a selection of SUSY and non-SUSY models ★★★★★ signals large effects, ★★ visible but small effects and ★ implies that the given model does not predict sizable effects in that observable.

[Nucl.Phys. B830 (2010) 17-94]

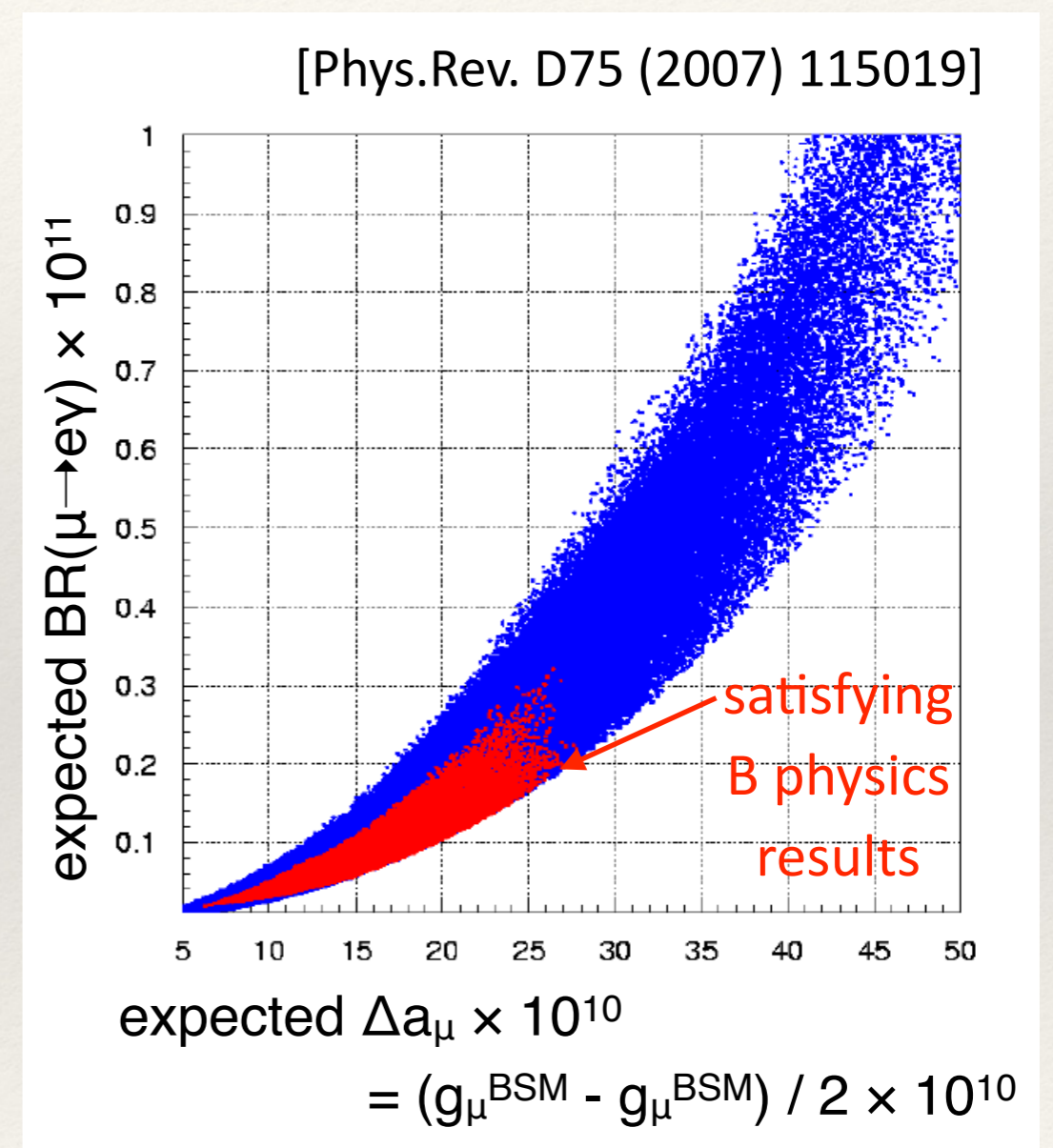

# Flavour physics

- ❖ Flavour physics is a powerful tool to search for NP, **potentially sensitive to a much higher NP scale than LHC.**

Depends of course on how much new particles couple to SM ones.

- ❖ But precision measurements are also **sensitive to very light new particles:**

- ❖ very light Higgs,
- ❖ dark photon,
- ❖ light dark matter.

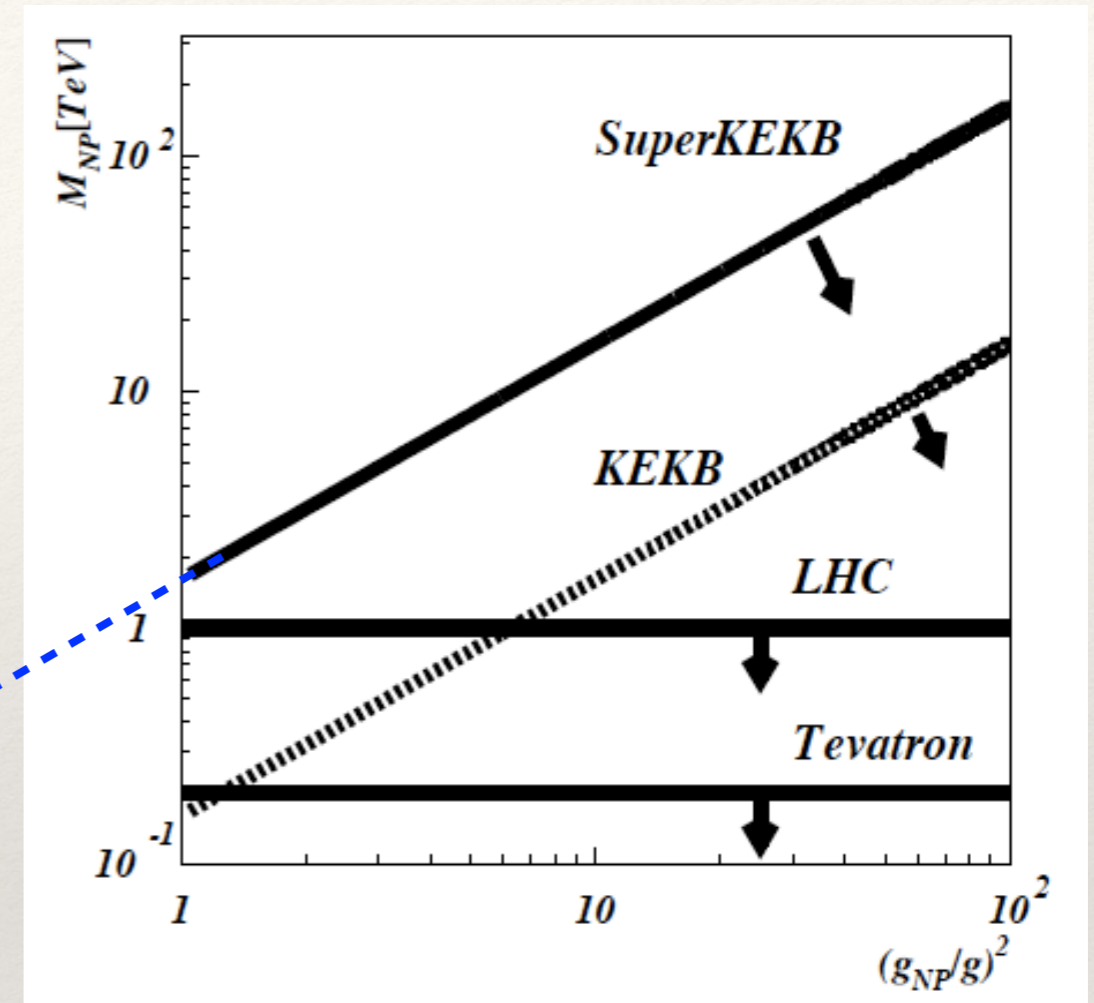

# Course outline

- ❖ Introduction to the standard model
- ❖ The CKM formalism
- ❖ Limitations of the SM
- ❖ **Effective Lagrangian of physics beyond the standard model**

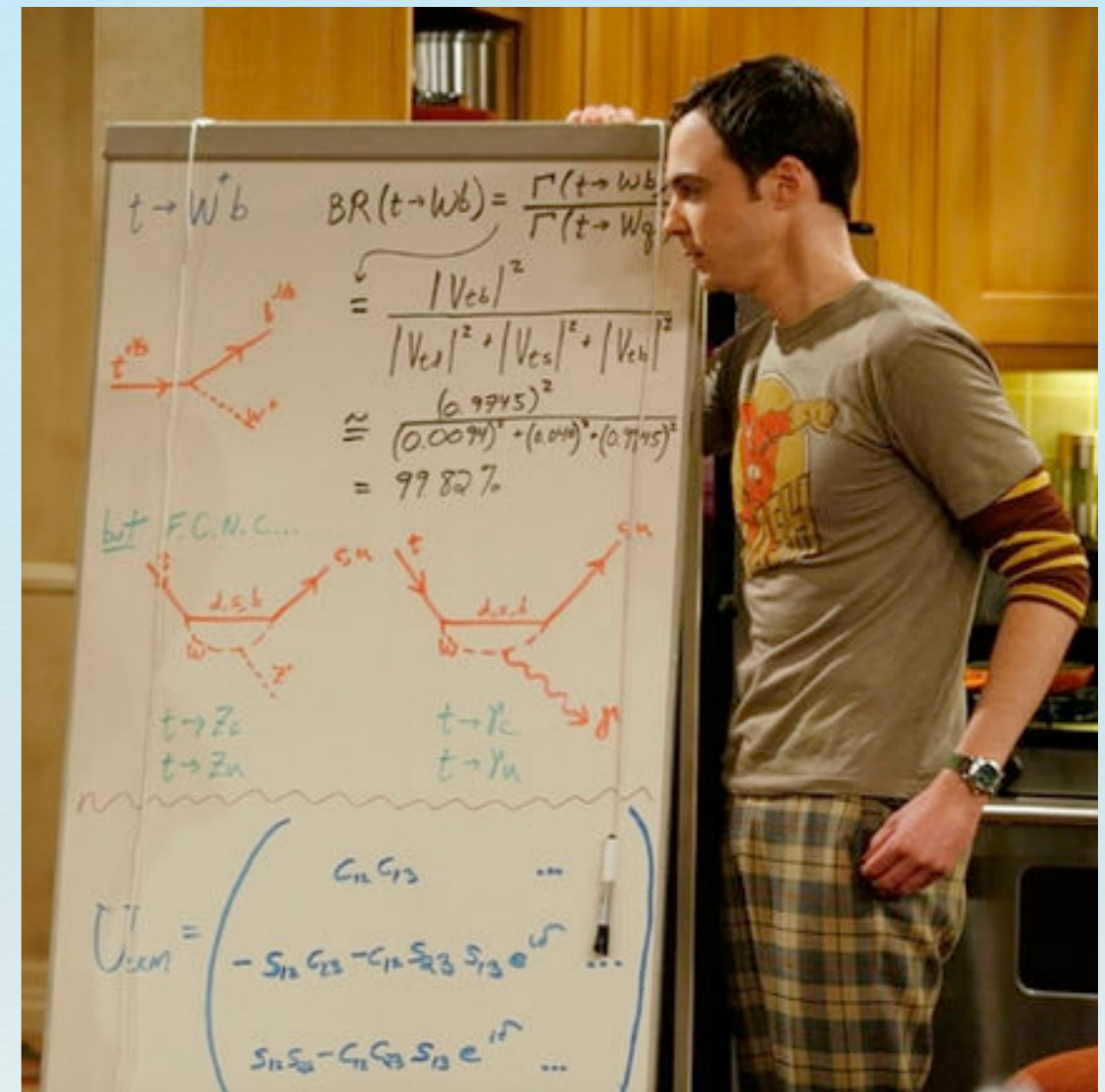

# Effective Lagrangian

- ❖ Assuming that SM is extended with new degrees of freedom arising at higher energy, analyse the possible NP effects **using a generic effective-theory**.

The diagram shows the Effective Lagrangian equation:  $\mathcal{L}_{\text{eff}} = \mathcal{L}_{\text{SM}} + \frac{g_{\text{NP}}}{\Lambda^2} \text{O}^{(6)}(\text{SM fields}) + \dots$ . The equation is enclosed in a blue rectangular box. Two red arrows point from external text to parts of the equation: one points to  $g_{\text{NP}}$  with the label "coupling constant", and another points to  $\Lambda^2$  with the label "NP scale:  $\Lambda \sim M_{\text{NP}}$ ".

$$\mathcal{L}_{\text{eff}} = \mathcal{L}_{\text{SM}} + \frac{g_{\text{NP}}}{\Lambda^2} \text{O}^{(6)}(\text{SM fields}) + \dots$$

coupling constant

NP scale:  
 $\Lambda \sim M_{\text{NP}}$

- ❖ NP contributions are known to be very small:
  - ❖ either  $\Lambda$  is very high,
  - ❖ or  $g_{\text{NP}}$  is very weak,
  - ❖ or both!

# Wilson coefficients

$$\mathcal{H}_{eff} = -\frac{4G_F}{\sqrt{2}} V_{tb} V_{ts}^* \sum_i (C_i \mathcal{O}_i + C'_i \mathcal{O}'_i)$$

V-A structure                      V+A structure  
(not existing in SM)

i=1,2 Tree  
i=3-6,8 gluon penguin  
i=7 photon penguin  
i=9,10 electroweak penguin  
i= S,P Scalar, Pseudo scalar penguin

- ❖ **Operators  $\mathcal{O}_i$**  describe long distance effects  
They depend on hadronic form factors → large theoretical uncertainties.
- ❖ **Wilson coefficients  $C_i$**  describe short distance effects (contact interaction)  
→ sensitive to New Physics contributions.

# Experimental constraints

[Ann.Rev.Nucl.Part.Sci. 60 (2010) 355]

Bounds on dim-6  
 $\Delta F = 2$  operators:

Operator	Bounds on $\Lambda$ in TeV ( $c_{ij} = 1$ )		Bounds on $c_{ij}$ ( $\Lambda = 1$ TeV)		Observables
	Re	Im	Re	Im	
$(\bar{s}_L \gamma^\mu d_L)^2$	$9.8 \times 10^2$	$1.6 \times 10^4$	$9.0 \times 10^{-7}$	$3.4 \times 10^{-9}$	$\Delta m_K; \epsilon_K$
$(\bar{s}_R d_L)(\bar{s}_L d_R)$	$1.8 \times 10^4$	$3.2 \times 10^5$	$6.9 \times 10^{-9}$	$2.6 \times 10^{-11}$	$\Delta m_K; \epsilon_K$
$(\bar{c}_L \gamma^\mu u_L)^2$	$1.2 \times 10^3$	$2.9 \times 10^3$	$5.6 \times 10^{-7}$	$1.0 \times 10^{-7}$	$\Delta m_D;  q/p , \phi_D$
$(\bar{c}_R u_L)(\bar{c}_L u_R)$	$6.2 \times 10^3$	$1.5 \times 10^4$	$5.7 \times 10^{-8}$	$1.1 \times 10^{-8}$	$\Delta m_D;  q/p , \phi_D$
$(\bar{b}_L \gamma^\mu d_L)^2$	$5.1 \times 10^2$	$9.3 \times 10^2$	$3.3 \times 10^{-6}$	$1.0 \times 10^{-6}$	$\Delta m_{B_d}; S_{\psi K_S}$
$(\bar{b}_R d_L)(\bar{b}_L d_R)$	$1.9 \times 10^3$	$3.6 \times 10^3$	$5.6 \times 10^{-7}$	$1.7 \times 10^{-7}$	$\Delta m_{B_d}; S_{\psi K_S}$
$(\bar{b}_L \gamma^\mu s_L)^2$		$1.1 \times 10^2$		$7.6 \times 10^{-5}$	$\Delta m_{B_s}$
$(\bar{b}_R s_L)(\bar{b}_L s_R)$		$3.7 \times 10^2$		$1.3 \times 10^{-5}$	$\Delta m_{B_s}$

- Constraints from quark-flavour physics on NP energy scale:  $\Lambda > 10^3$  TeV, considering  $g_{NP} \sim 1$ , and **new particles at the TeV scale imply non generic flavour structure of any BSM theory.**
- N.B.: constraints from charged lepton flavour violating decays:  $\Lambda > 10^5$  TeV.

# Experimental constraints on $C_7$ and $C_7'$

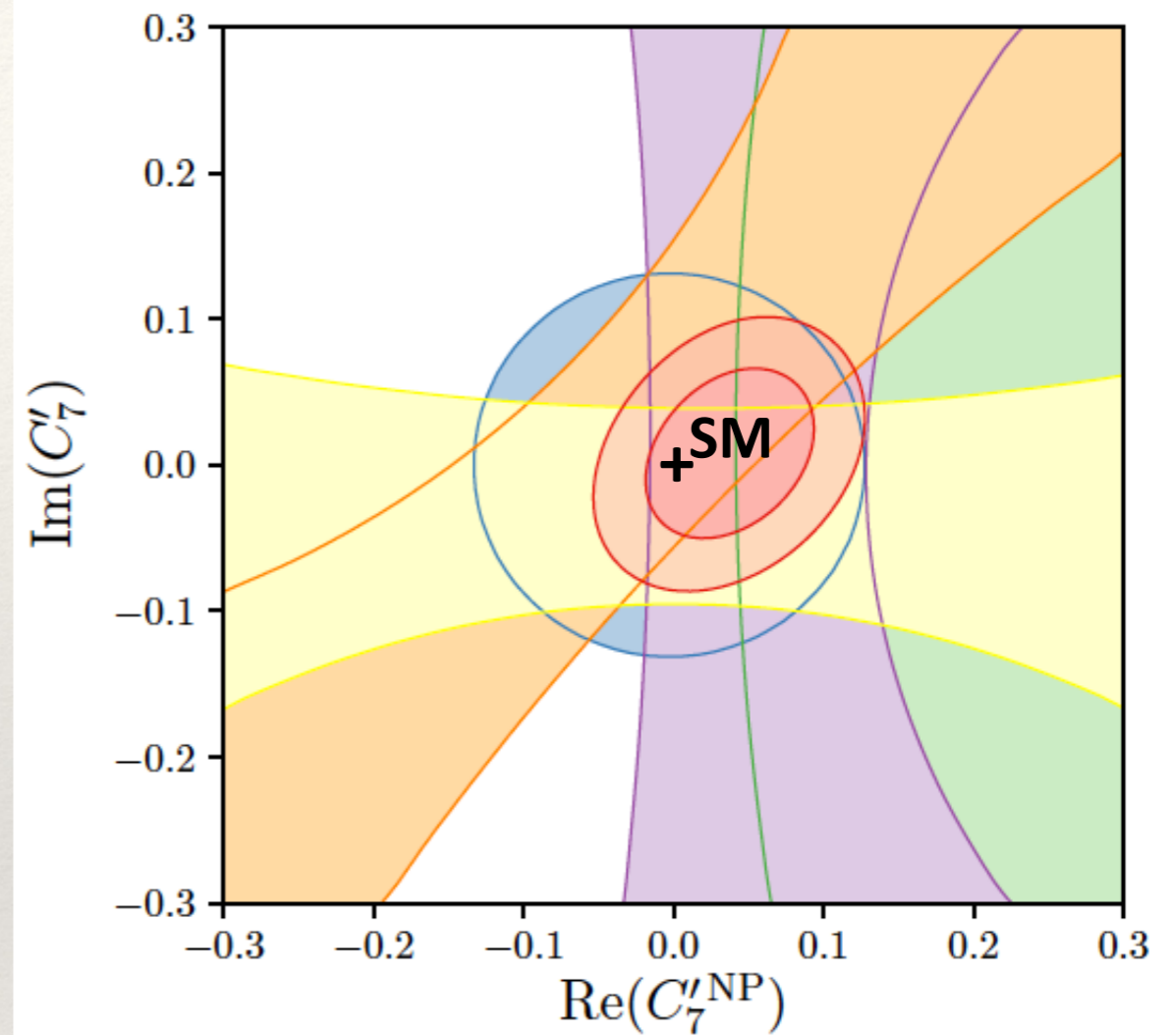
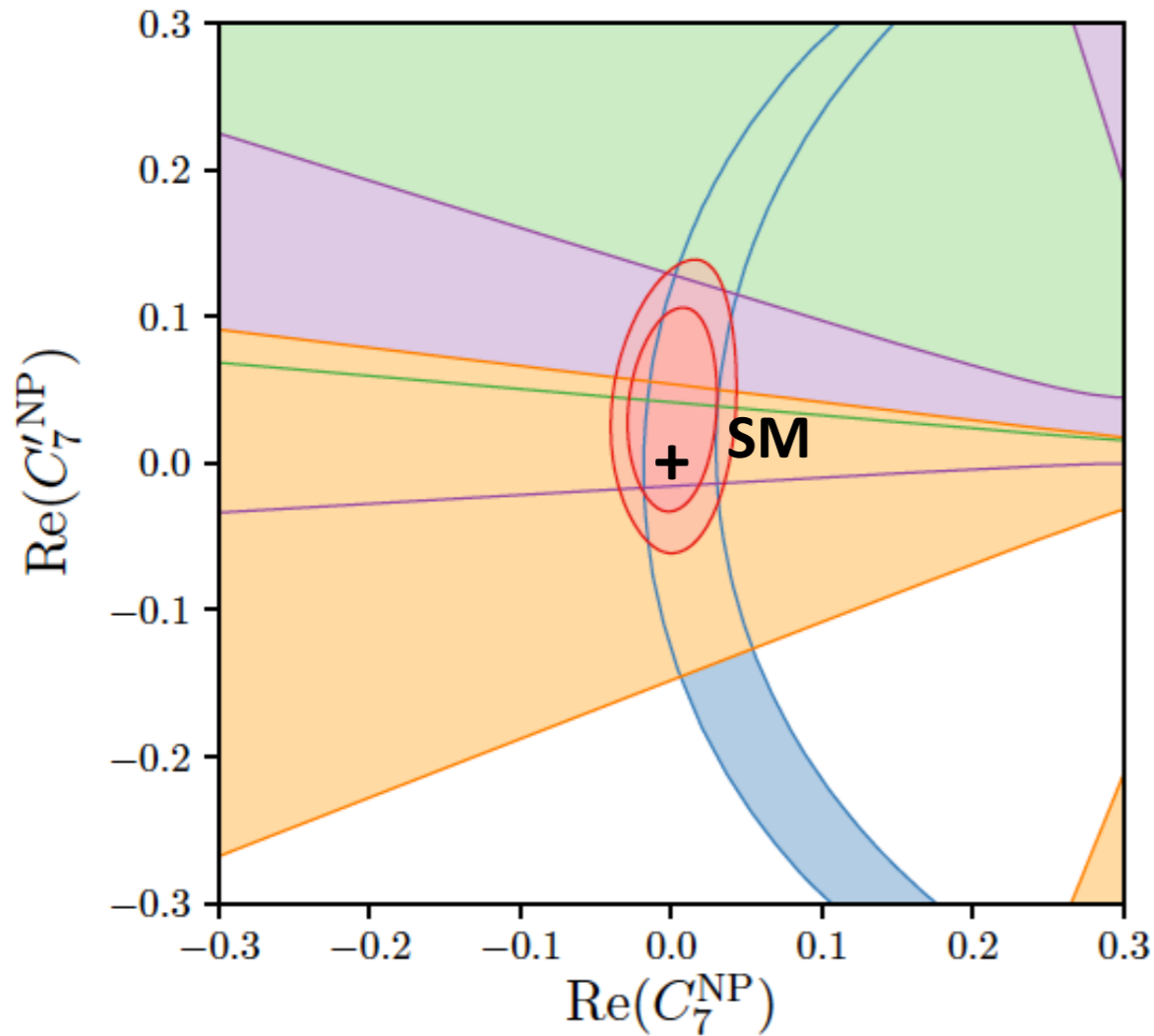

- branching ratios
- $A_{\Delta\Gamma}(B_s \rightarrow \phi\gamma)$
- $\langle P_1 \rangle(B^0 \rightarrow K^{*0}e^+e^-)$
- $S_{K^*\gamma}$
- $\langle A_T^{\text{Im}} \rangle(B^0 \rightarrow K^{*0}e^+e^-)$
- global

[A. Paul, D. Straub, arXiv:1608.02556, 2017)



---

# Conclusion

---

- ❖ An exciting program of sensitive searches at the intensity frontier is awaiting us, made possible thanks to significant progresses in accelerator and detector technologies.
- ❖ Flavour physics and precision measurements at low energies may be the only way to reach the Zepto-Universe (10 TeV and above,  $10^{-21}$  m) in the next decade. If the scale of NP is not under experimental reach, it is a powerful tool to constrain NP models.
- ❖ The actual conclusion is that a variety of approaches is needed to address the question of BSM, as well with experiments at the energy frontier, at the intensity frontier and at the cosmic frontier.

The key word is complementarity: not only the sensitivity to NP is enhanced, but also it is the only way to understand the structure of NP and the flavour-breaking pattern once NP is discovered.

thank you for your attention

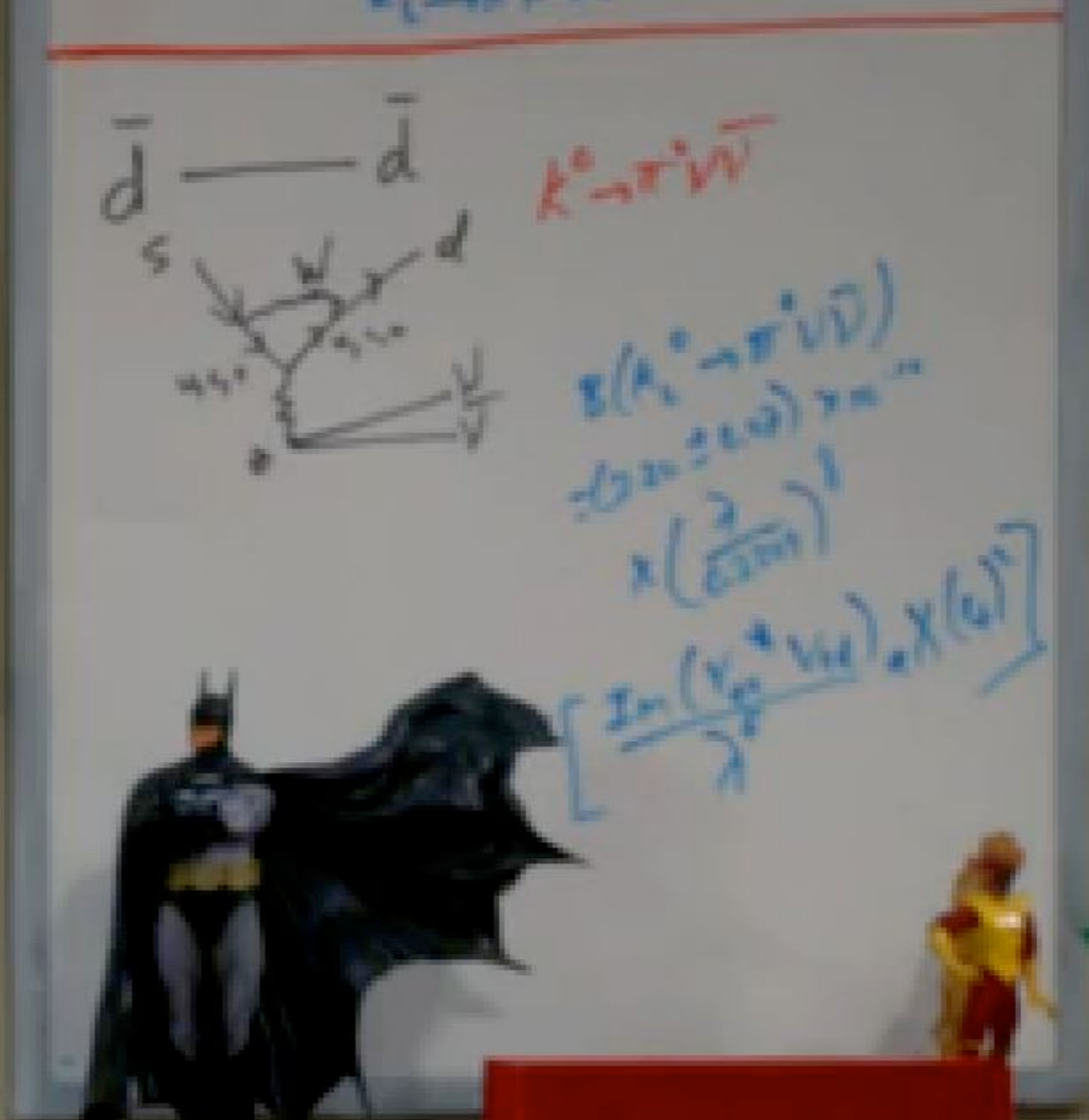

# Weak mixing angle $\sin\theta_w$

## ❖ $SU(2)_L$ :

3 group generators  $\rightarrow$  3 fields  $W_\mu^{1,2,3}$  (introduced through the covariant derivative).

Physical bosons mediating charged weak interaction  $W^+$  and  $W^-$  are made of  $W_\mu^1$  and  $W_\mu^2$ :

$$W^\pm = (W_\mu^1 \mp W_\mu^2) / \sqrt{2}.$$

But physical Z boson  $\neq W_\mu^3$  because  $W_\mu^3$  couples only left handed fermions while Z couples also to right projection.

## ❖ $U(1)_Y$ :

1 group generator  $\rightarrow$  1 field  $B_\mu$ .

## ❖ $SU(2)_L \times U(1)_Y$ :

Electroweak unification:  $W_\mu^3$  (from  $SU(2)$ ) and  $B_\mu$  (from  $U(1)$ ) fields are mixed to make  $Z_\mu$  field and photon  $A_\mu$  field:

$$\begin{pmatrix} A_\mu \\ Z_\mu \end{pmatrix} = \begin{pmatrix} \cos \theta_w & -\sin \theta_w \\ \sin \theta_w & \cos \theta_w \end{pmatrix} \begin{pmatrix} B_\mu \\ W_\mu^3 \end{pmatrix} \quad \text{weak mixing angle } \theta_w$$

$\rightarrow$  coupling constants:  $g \sin\theta_w = g' \cos\theta_w = e$