



# CCIN2P3 Networks



[jerome.bernier@in2p3.fr](mailto:jerome.bernier@in2p3.fr)  
June 2014



# IN2P3 network



The CCIN2P3 is responsible for the connectivity of all the IN2P3 laboratories !

-> 23 sites

Laboratories manage their LAN



# IN2P3 connectivity



Based on NREN RENATER  
and multiple  
regional/metropolitan/campus networks  
plus some links ordered through call of tender

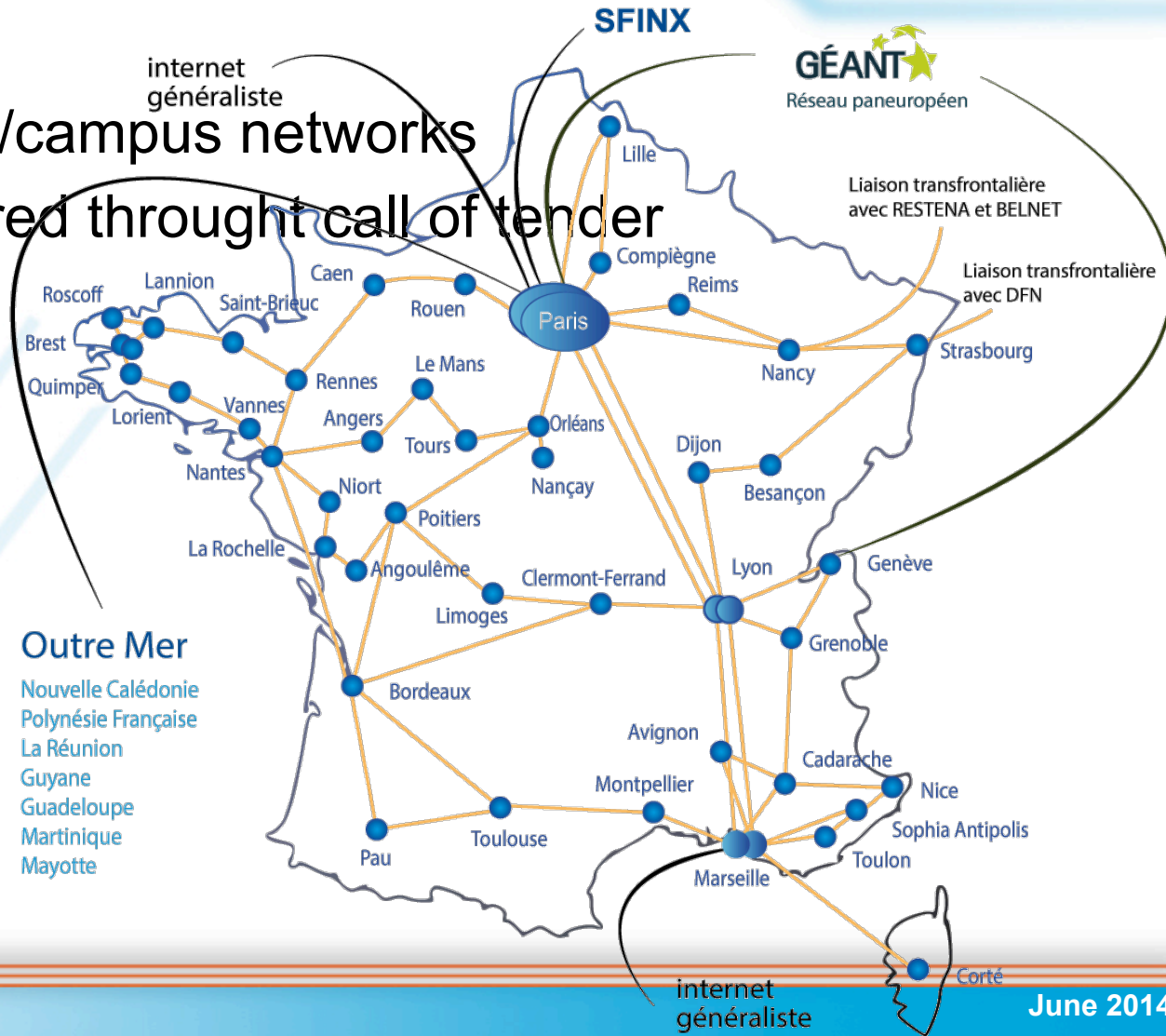





## The Pan-European Research and Education Network

GÉANT interconnects Europe's National Research and Education Networks (NRENs). Together we connect over 50 million users at 10,000 institutions across Europe.

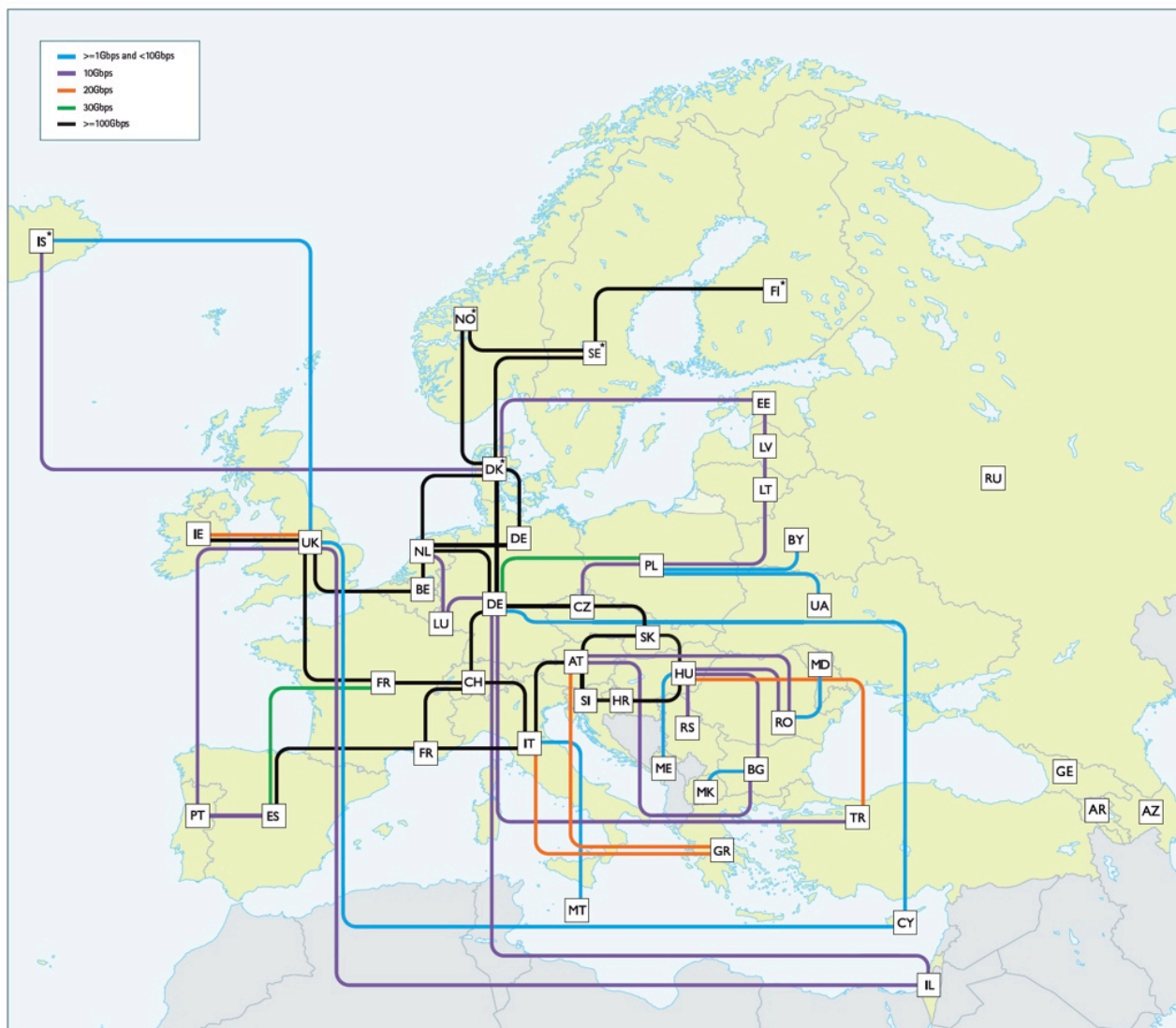

# GÉANT At the Heart of Global Research Networking

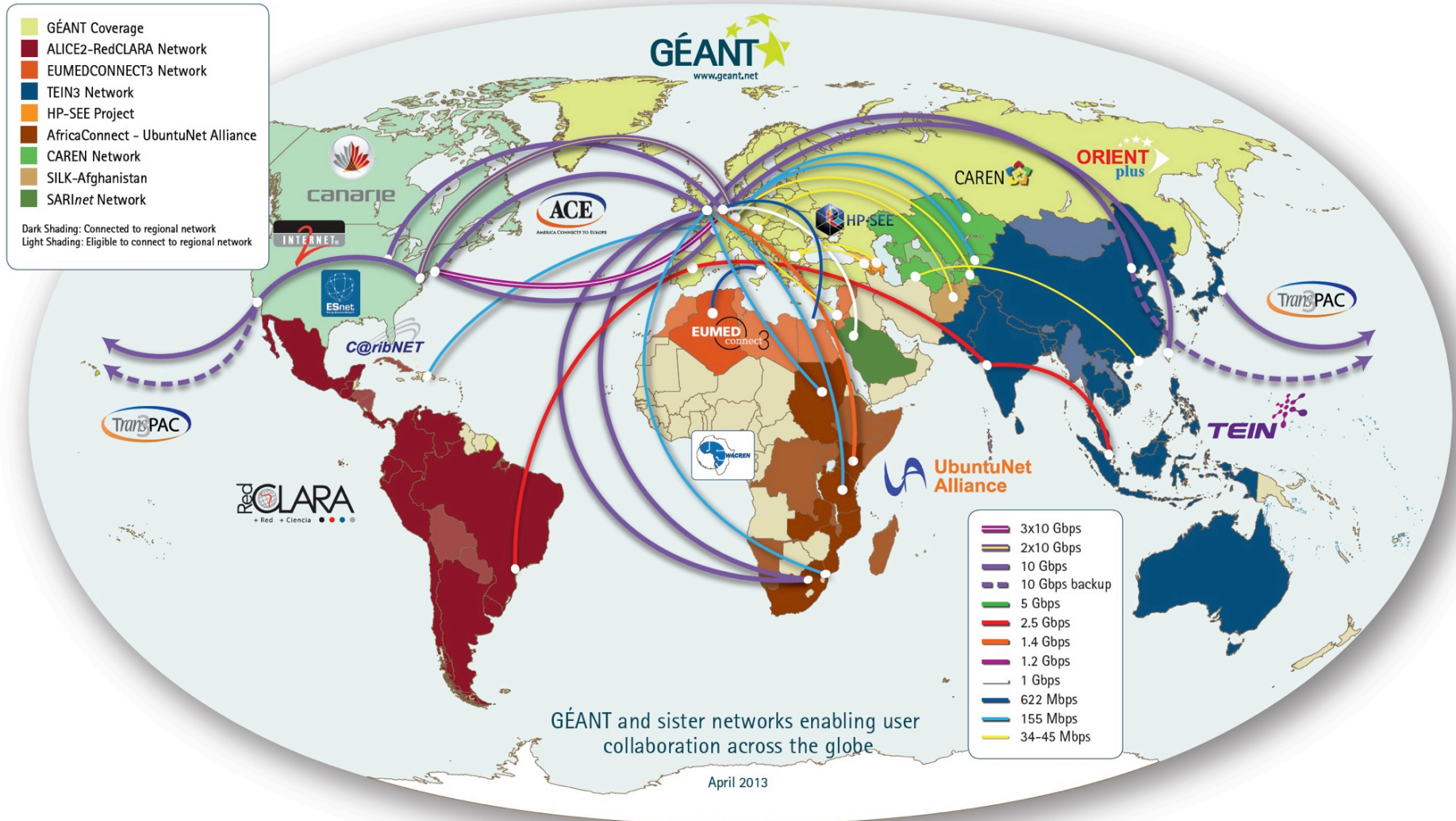

# LHCOPN

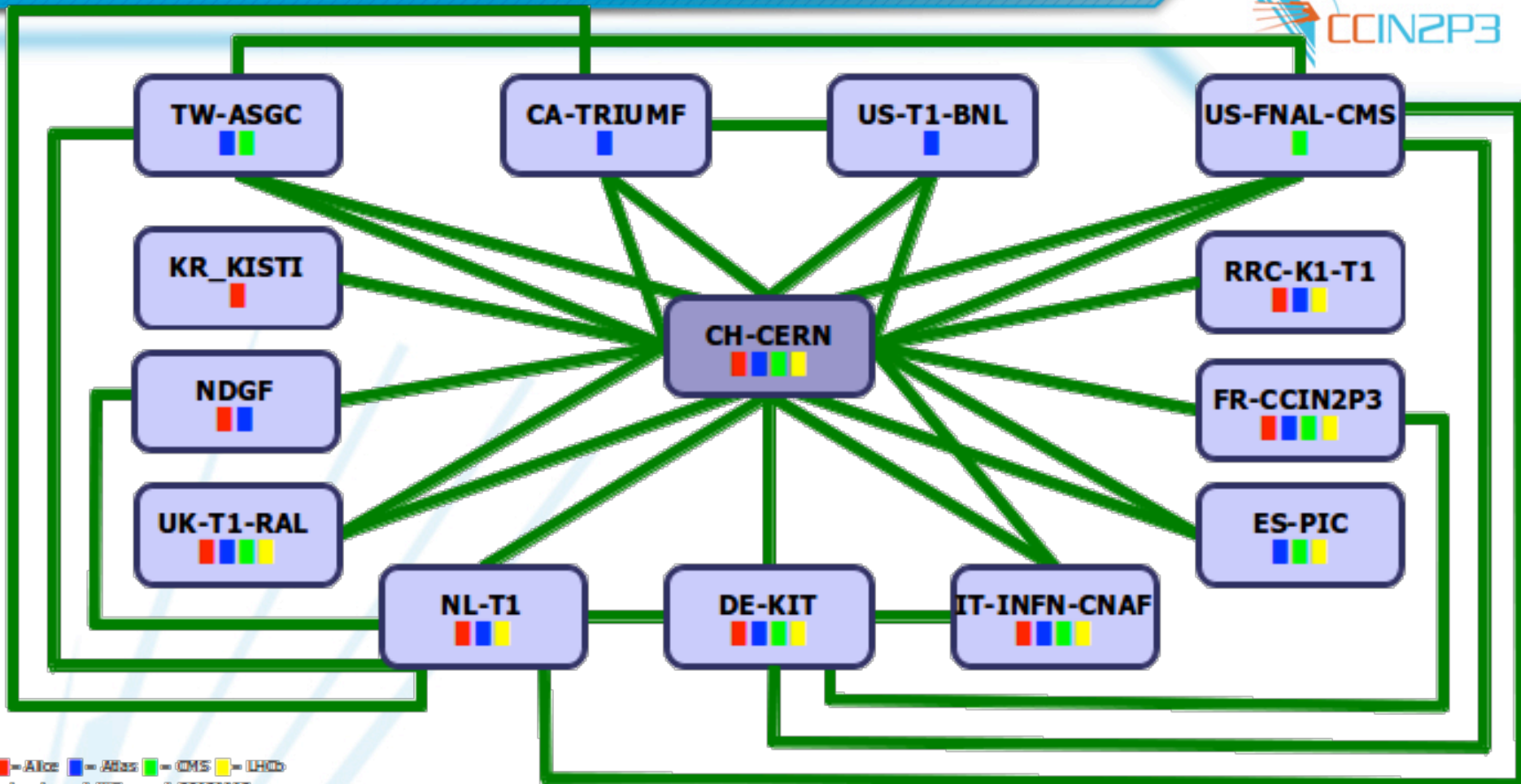



edoardo.marzelli@cern.ch 20131113



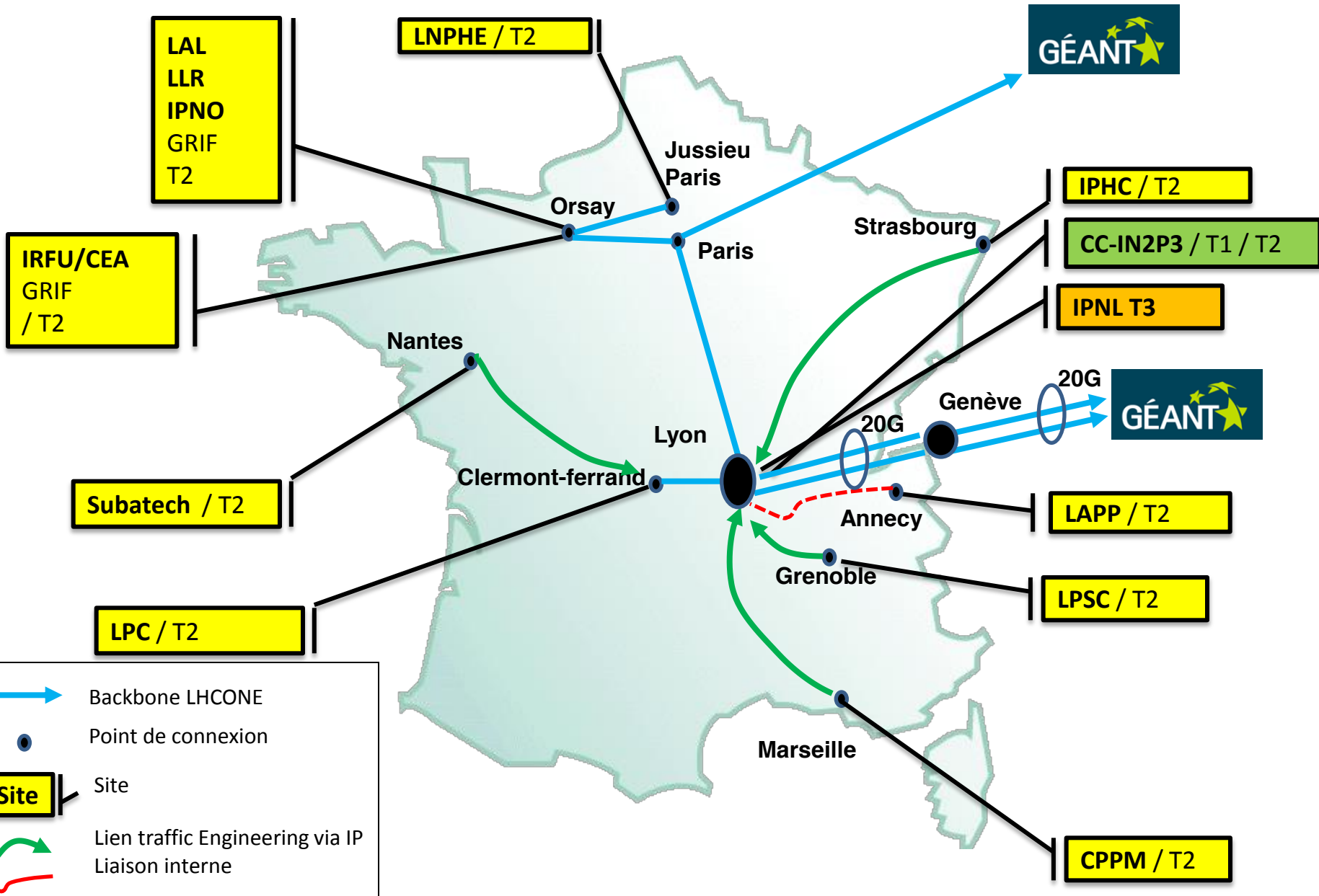

# LHCONE nov. 2013



**LHCONE**

-  Dedicated 10G λ
-  New Dedicated 10G λ
-  Pseudowire MPLS-TE

**LHCOPN**

-  Dedicated 10G λ
-  Optical backup

GRIF - Distributed T2

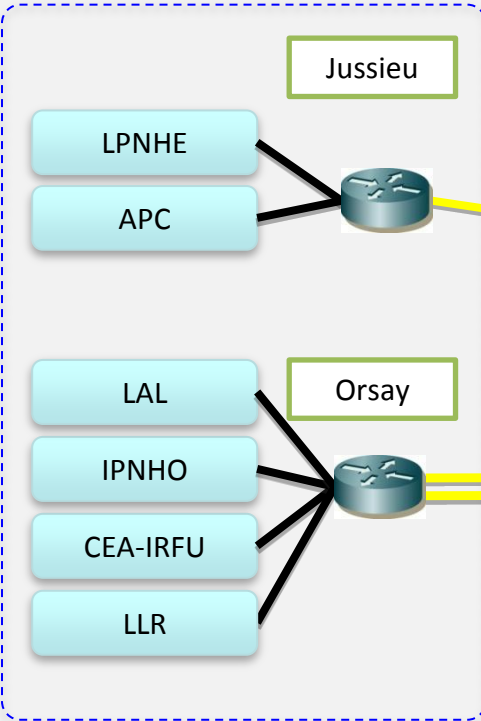

Others T2

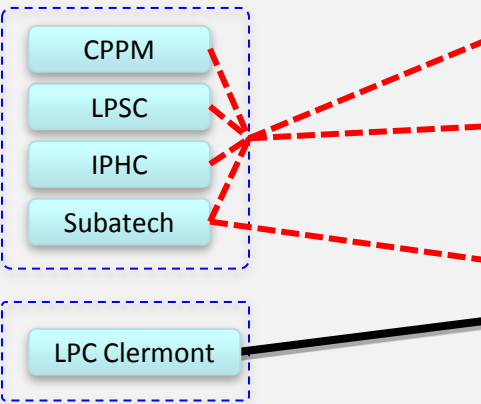

T1

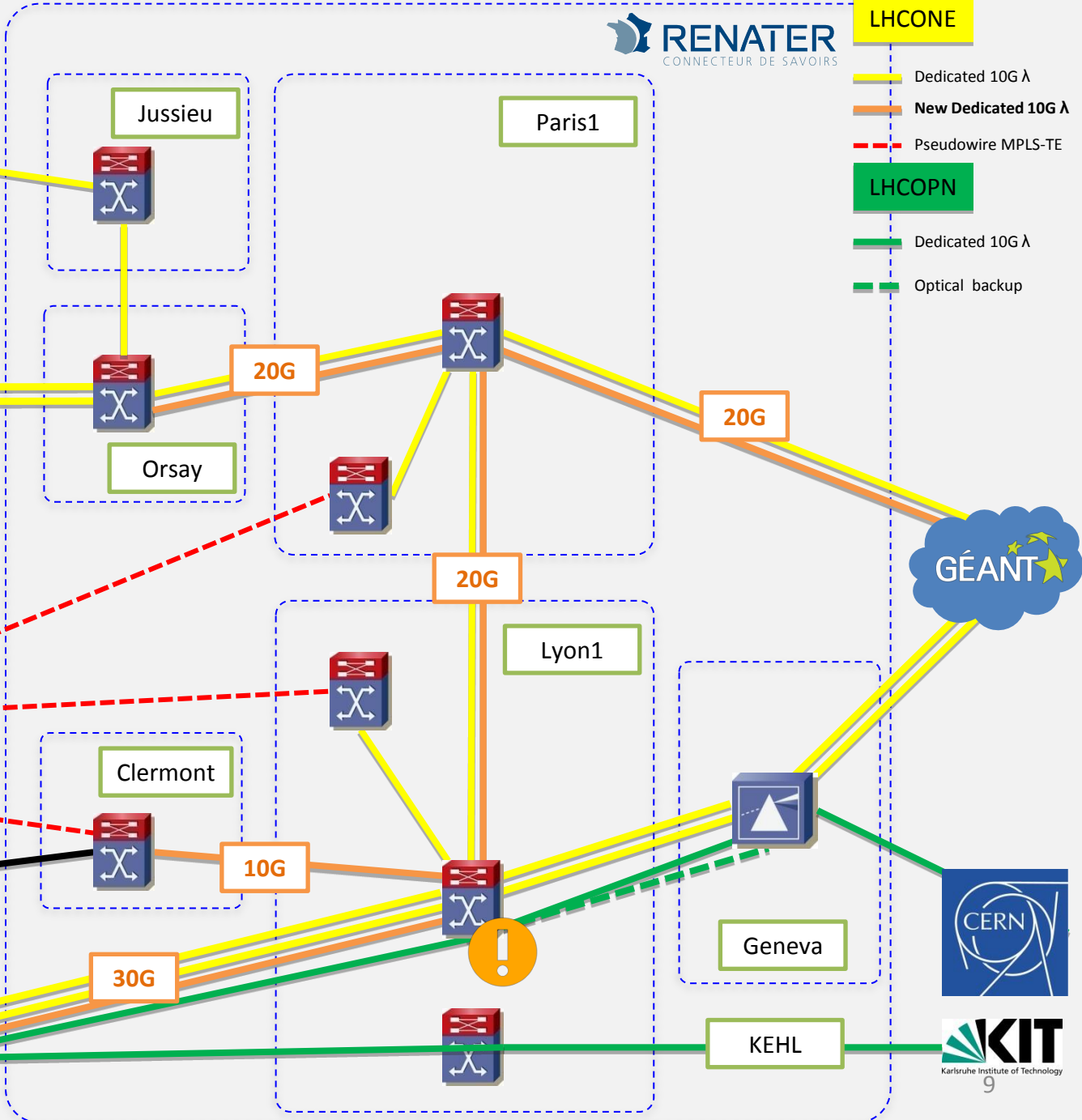
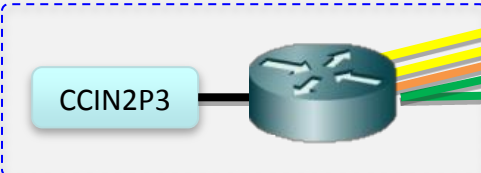



# T2 GRIF Paris

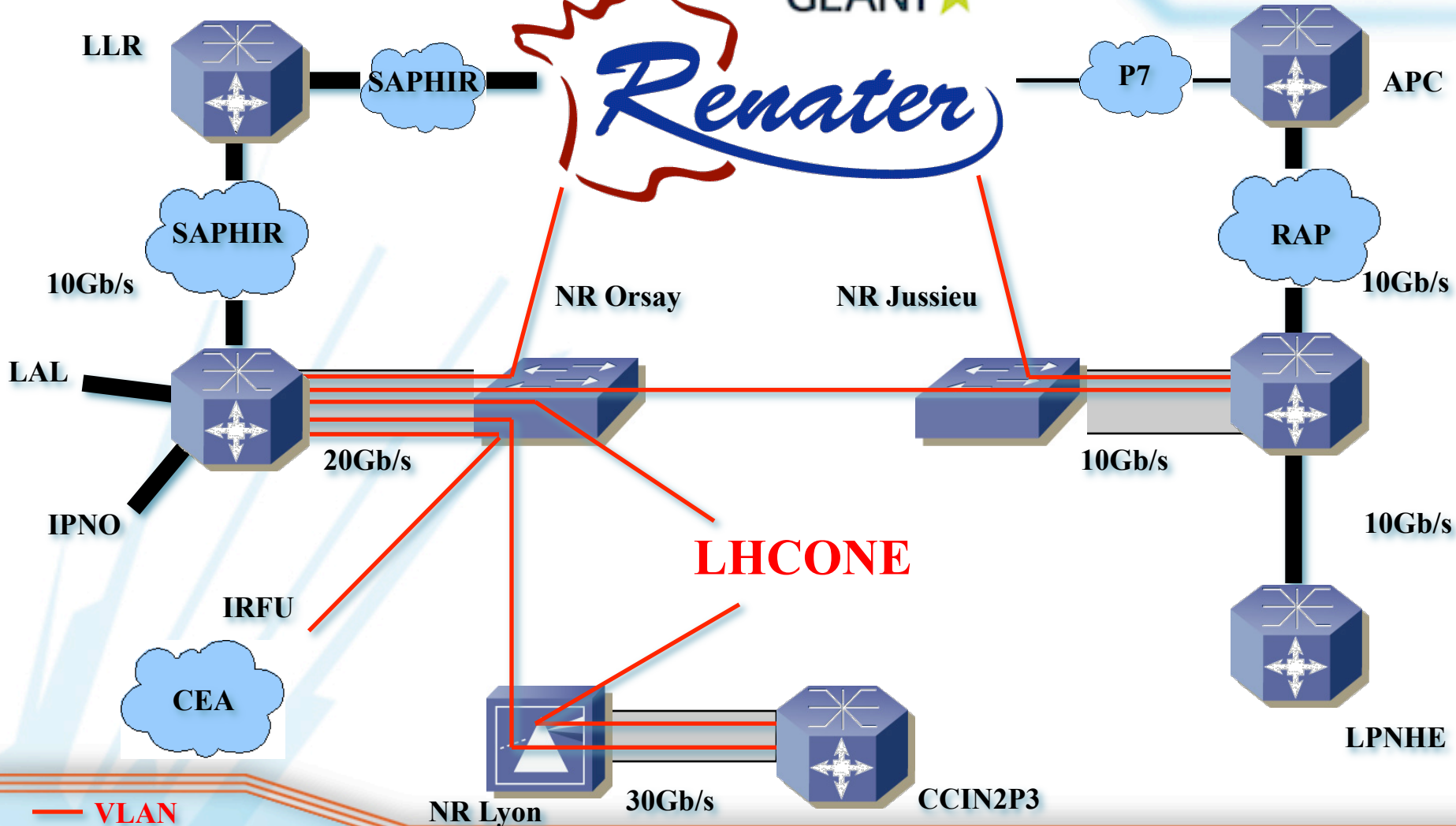

— VLAN

CCIN2P3

June 2014

# CCIN2P3 connectivity



6x 10Gb/s links

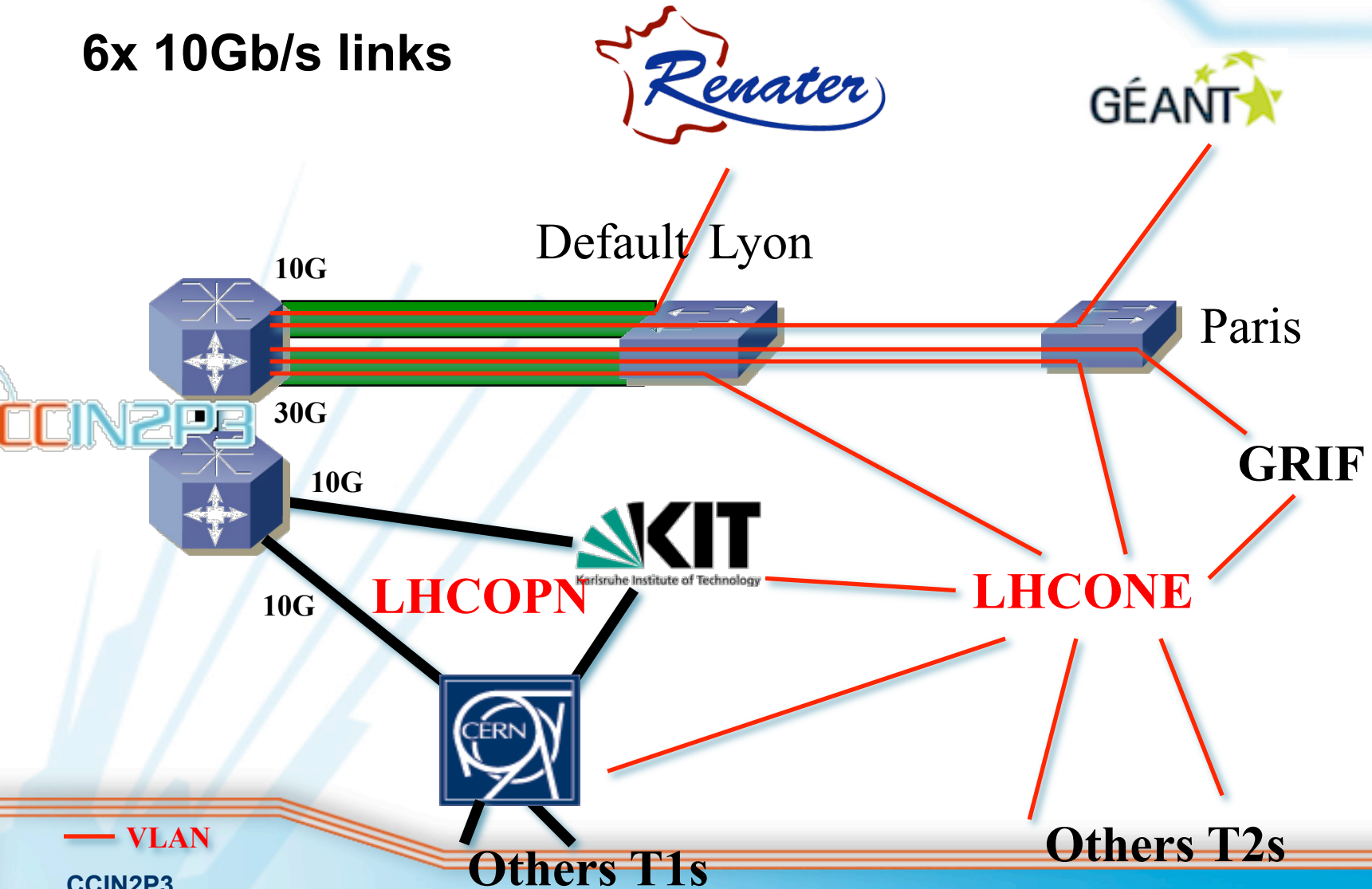

— VLAN

CCIN2P3

June 2014

# CCIN2P3 connectivity



6x 10Gb/

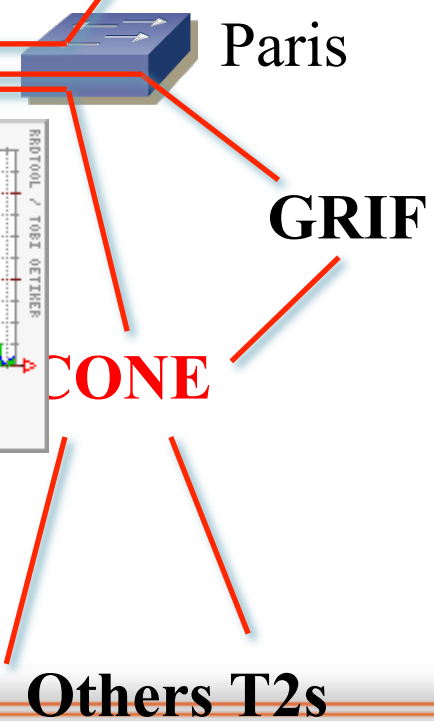
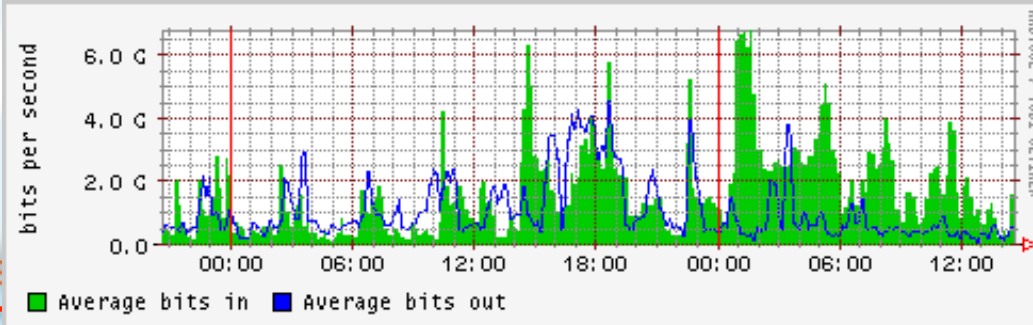
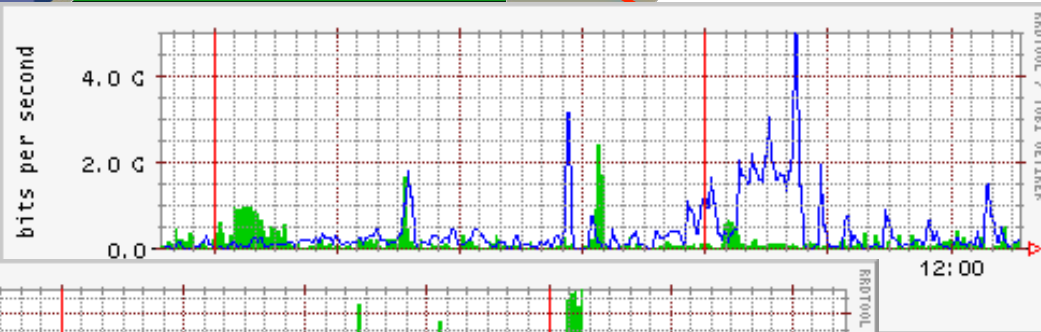
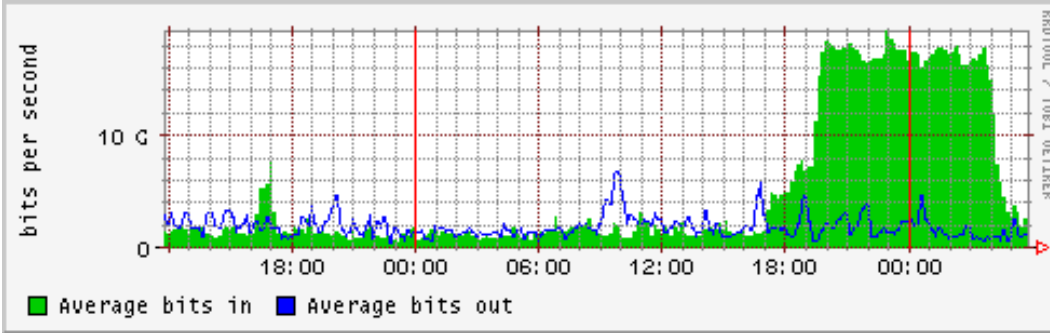
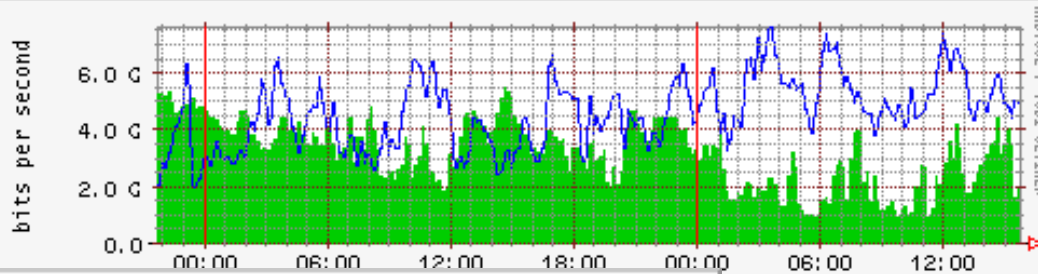





# CCIN2P3 LAN



> 1000 computing servers



> 500 data servers



> 15 PB RAID disk



4 libraries of 10K tapes  
> 40 PB



# CCIN2P3 LAN

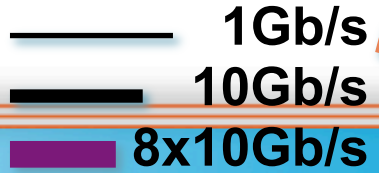
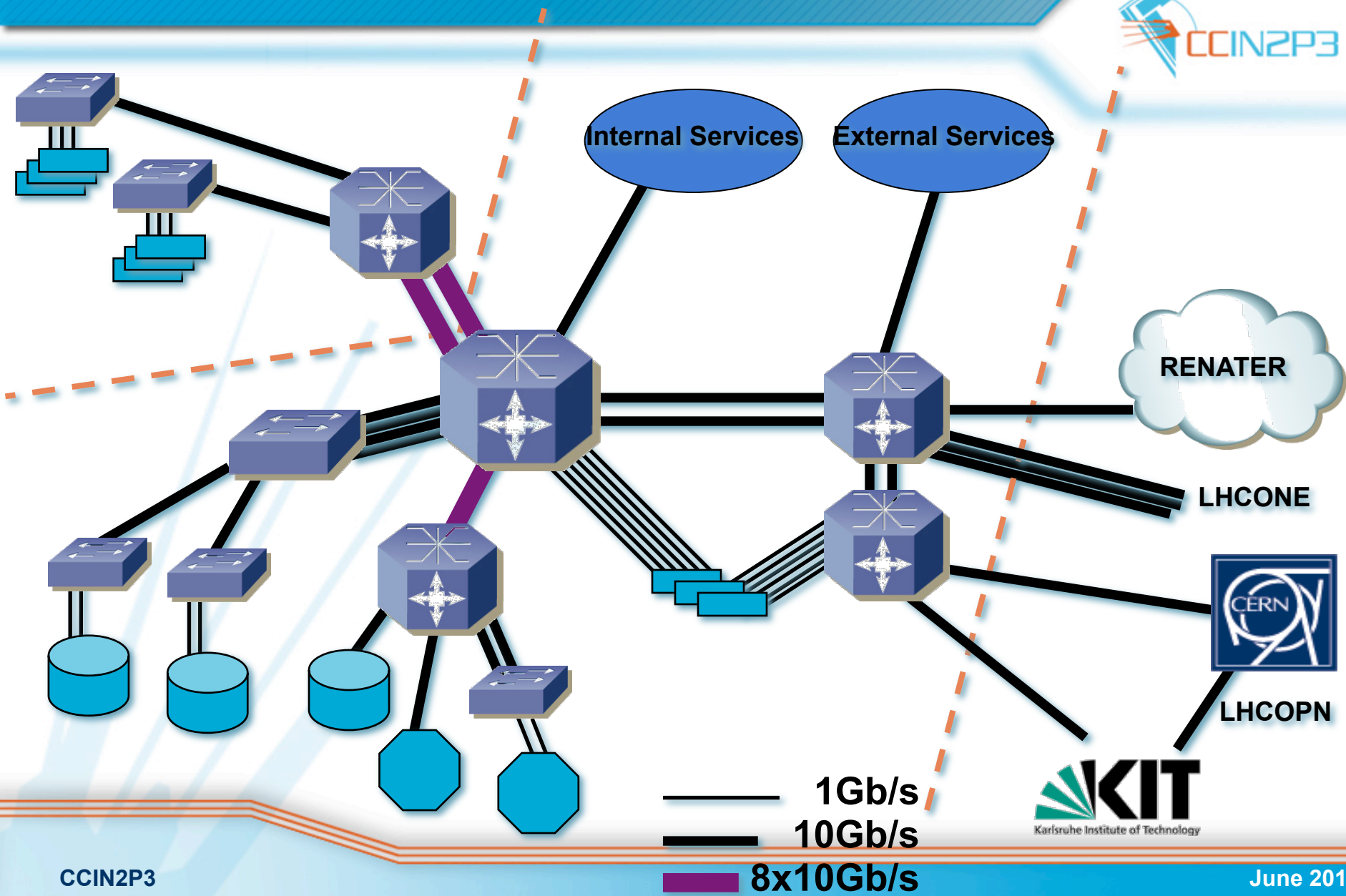



# CCIN2P3 LAN

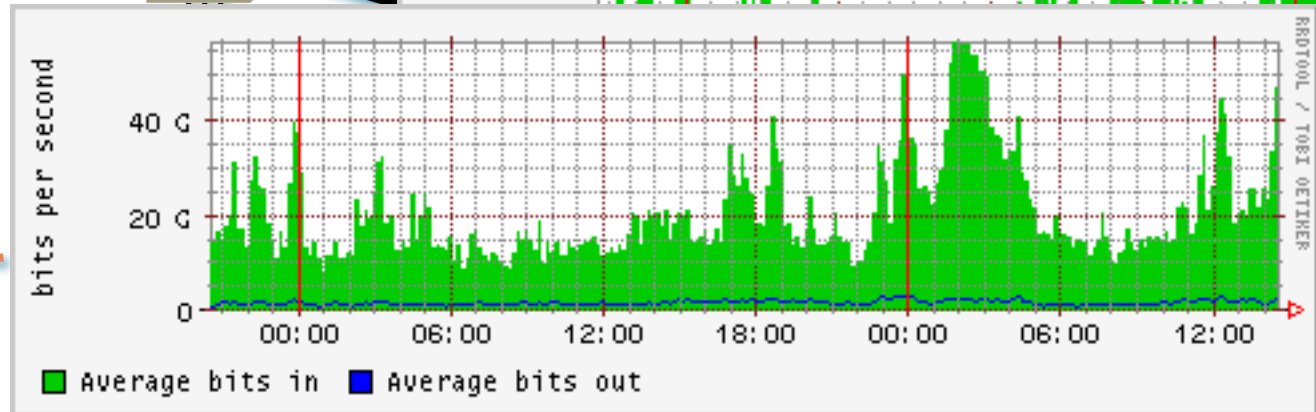
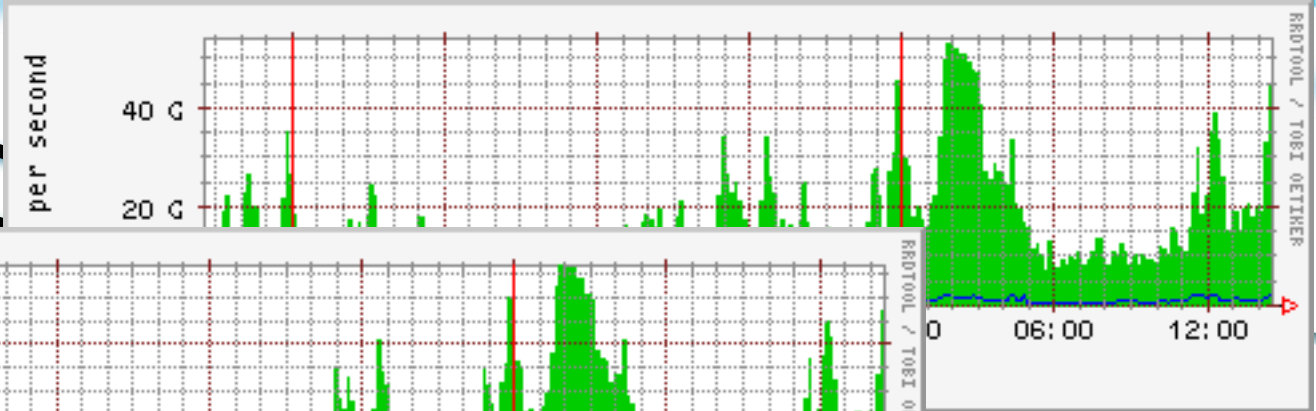
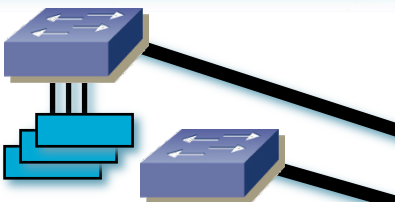

LHCONE



LHCOPN

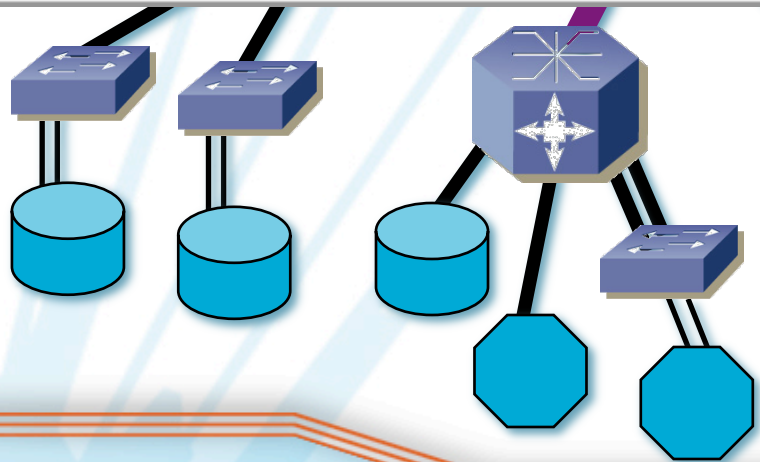

— 1Gb/s  
 — 10Gb/s  
 — 8x10Gb/s



# IN2P3 Statistics

<http://netstat.in2p3.fr>

