



# Observer l'infiniment grand

A.Tartari, APC & PCCP

après plusieurs discussions passionnantes avec M.Piat et D.Prêle

Rencontres de physique de l'infiniment grand  
à l'infiniment petit - 26 Juillet 2017



LabEX UnivEarthS



# La Photosphère de l'Univers



<http://solarscience.msfc.nasa.gov/surface.shtml>

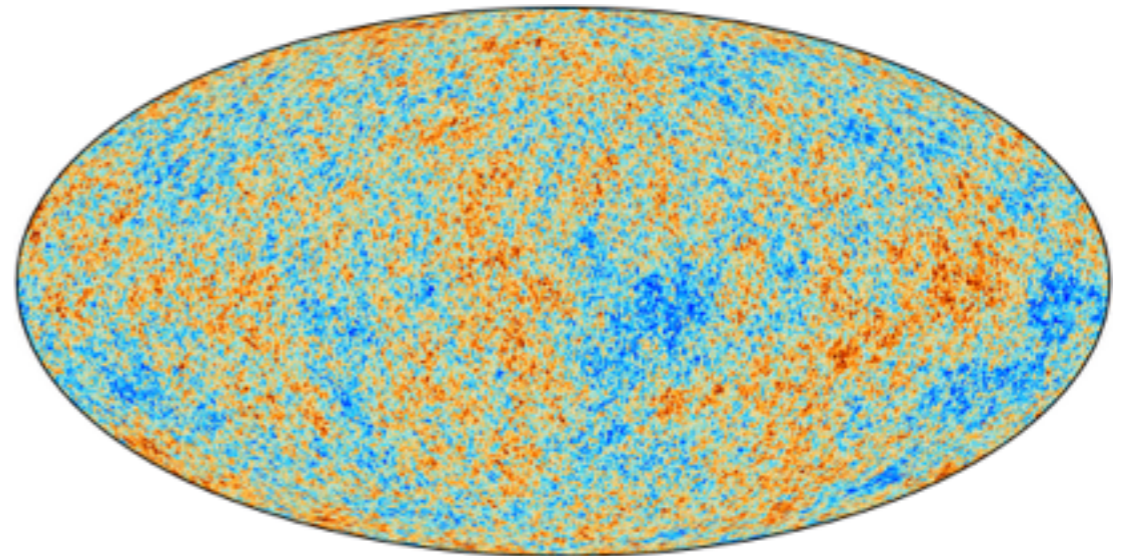

[http://www.esa.int/Our\\_Activities/Space\\_Science/Planck](http://www.esa.int/Our_Activities/Space_Science/Planck)

Une surface de transition  
milieu opaque => milieu transparent

- À  $t=300000$  ans, l'Univers devient transparent à un rayonnement thermique à la température de 3000 K.
- Il s'agit de la lumière d'arrière-plan qu'on observe aujourd'hui à  $T \approx 3\text{K}$ .  
Le "Cosmic Microwave Background" (CMB).

# Le CMB: propriétés statistiques

Un spectre de Corps Noir à  $T=2.725\pm 0.001$  K

$$\rho_\gamma = 0.26 \text{ eV/cm}^3$$

$$n_\gamma = 411 \text{ photons/cm}^3$$

## COBE-FIRAS

2.725K, Isotrope  
(à l'ordre zero)

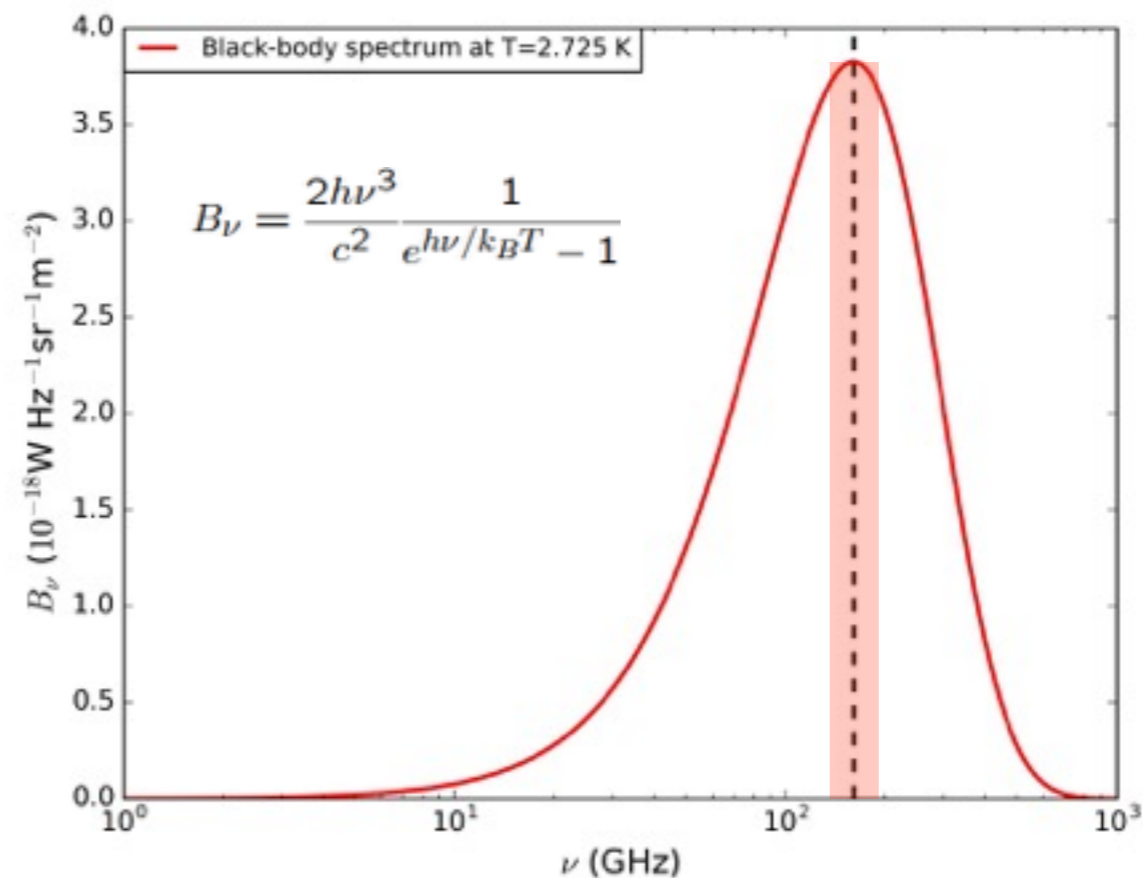

- \* Optique limitée par la diffraction:  $A\Omega = \lambda^2$
- \*  $P \approx 3.7 \times 10^{-18} (\text{W Hz}^{-1} \text{sr}^{-1} \text{m}^{-2}) \times 2 \times 10^{10} (\text{Hz}) \times 4 \times 10^{-6} (\text{m}^2 \text{sr}) = 3 \times 10^{-13} \text{W}$
- \*  $J = \text{flux de photons (@ } \lambda = 2 \text{ mm)} = P/E_\gamma = 3 \times 10^{-13} \text{W} / 10^{-22} \text{J} = 3 \times 10^9 \text{ph/s}$

# Le CMB: les anisotropies

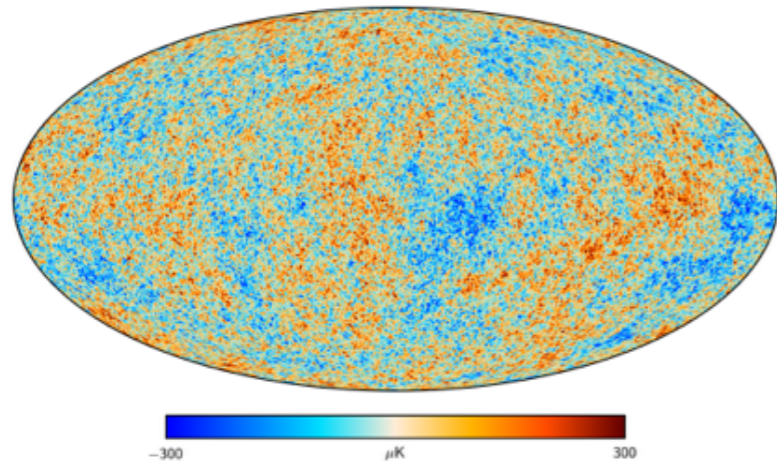

déTECTÉ →  $O(100 \mu\text{K})$

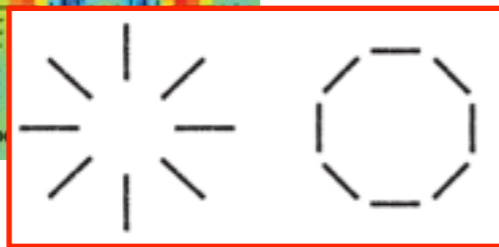
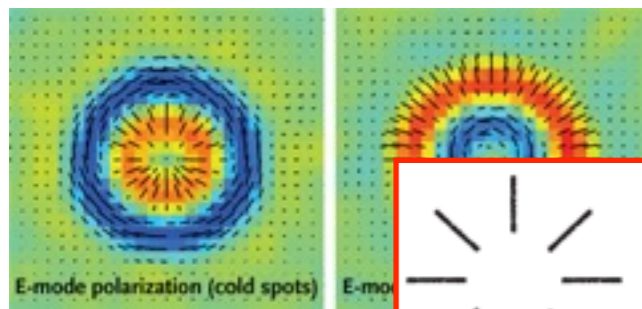

déTECTÉ →  $O(10 \mu\text{K})$

Big Bang breakthrough announced; gravitational waves detected

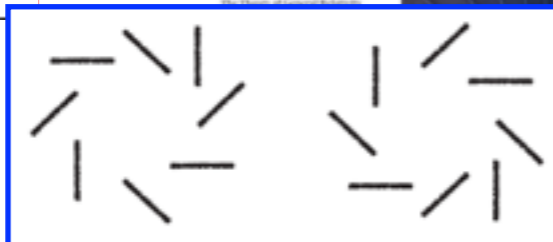
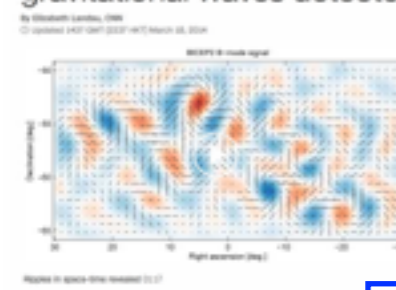

**< 70 nK ?**

# Telescopes et antennes

J.D. Kraus, *Radio Astronomy - Hanany, Niemack & Page, CMB Telescopes*

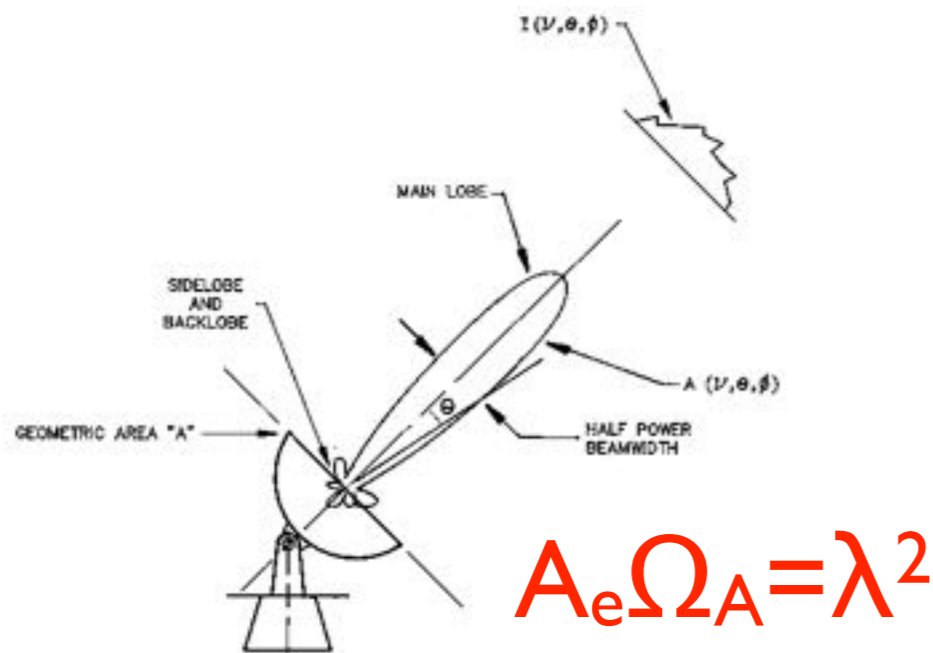

$$A_e \Omega_A = \lambda^2$$

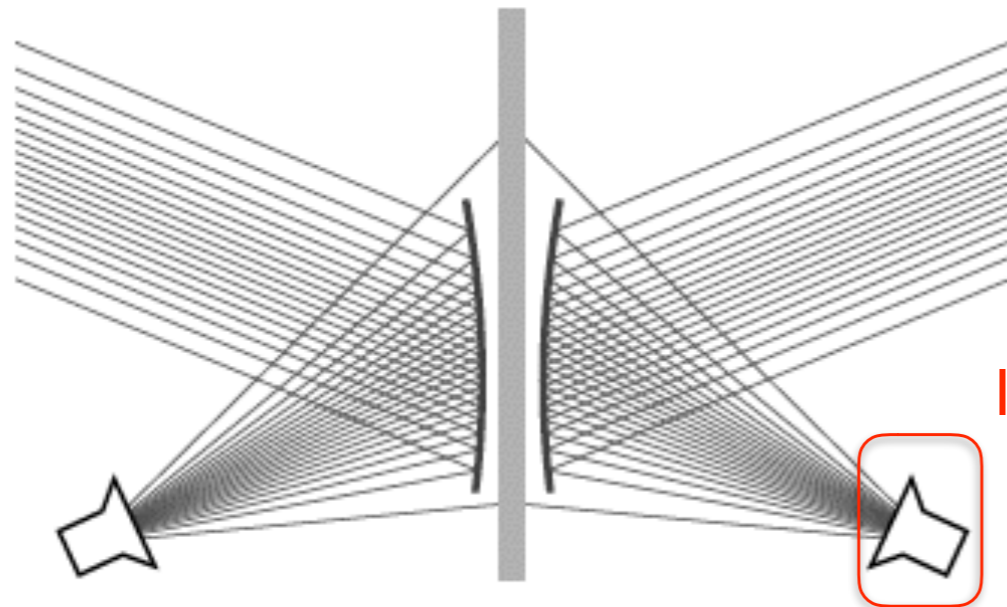

Fig. 10-7

Left: The ACT 6-m telescope in northern Chile. The telescope is inside the 13-m-tall ground screen. The secondary is just visible near the center of the ground screen. Right: The SPT 10-m telescope at the South Pole. Most of the circular primary reflector is visible, while the cryogenic secondary reflector and receiver are housed inside the white structure below and to the right of the primary (Photos courtesy of ACT and SPT Collaborations)

1. Le télescope permet d'atteindre une résolution de l'ordre de  $\lambda/D$  (limite de diffraction). **E.g. 8' @  $\lambda=2$  mm et  $D=1$  m.**
2. Au foyer, des structures capables de capter les ondes électromagnétiques focalisées par le télescope, et les renvoyer vers un amplificateur (détection cohérente), ou vers un détecteur direct (détection incohérente).

# Telescopes et antennes



le cornet (feed)

Figure 1.5. A differential radiometer using back-to-back off-axis paraboloidal dishes. The feeds are designed to mainly illuminate the center of the dishes with minimal spillover past the edges.

WMAP concept

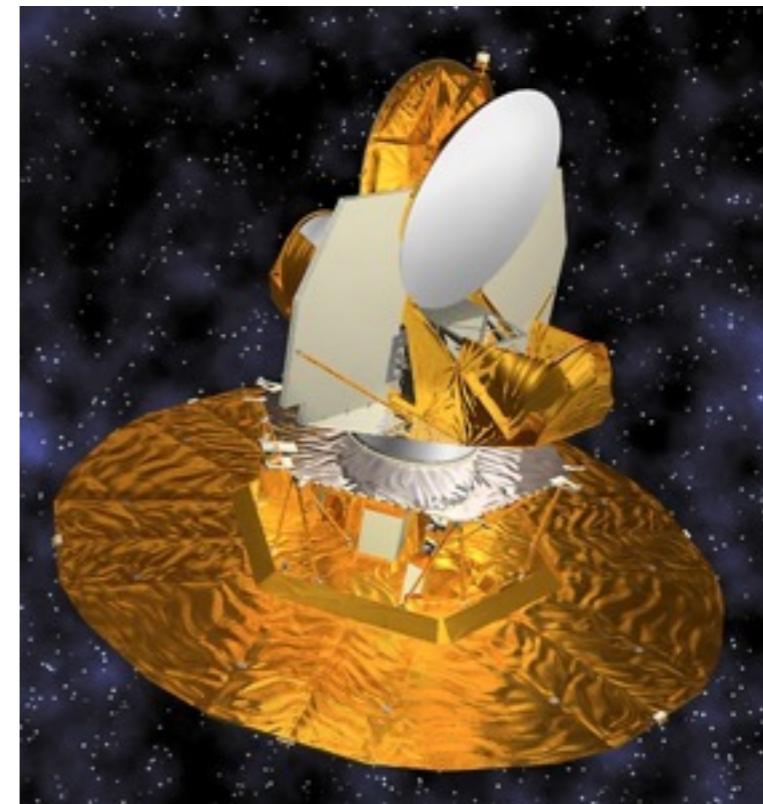

# Telescopes et antennes (et la limite de diffraction)

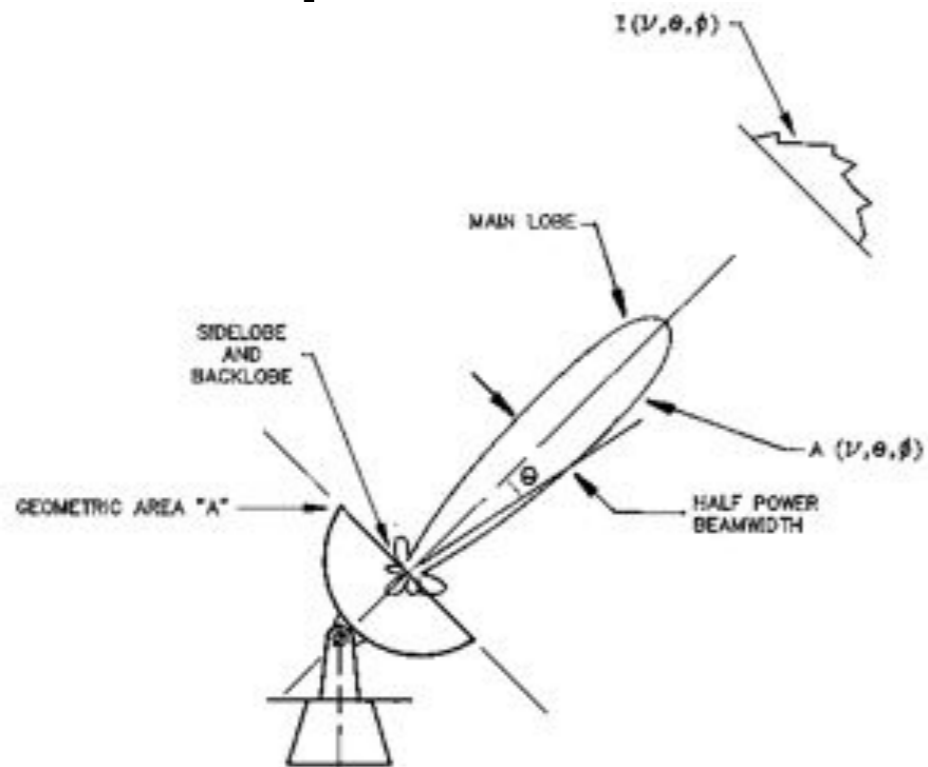

$$A_e \Omega_A = \lambda^2$$

- ❖ Une possibilité: abandonner la réponse gaussienne pour augmenter l'étendue optique d'un facteur  $N$ , number of modes (COBE-FIRAS, PIXIE, LSPE)

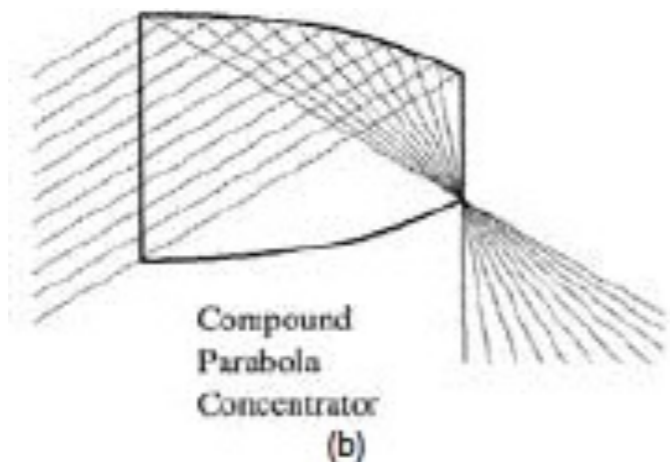

$$A_e \Omega_A = N \lambda^2$$

## The Measurement of Thermal Radiation at Microwave Frequencies

R. H. DICKE\*

*Radiation Laboratory, Massachusetts Institute of Technology, Cambridge, Massachusetts\*\**

(Received April 15, 1946)

The connection between Johnson noise and blackbody radiation is discussed, using a simple thermodynamic model. A microwave radiometer is described together with its theory of operation. The experimentally measured root mean square fluctuation of the output meter of a microwave radiometer ( $0.4^{\circ}\text{C}$ ) compares favorably with a theoretical value of  $0.46^{\circ}\text{C}$ . With an r-f band width of 16 mc/sec., the  $0.4^{\circ}\text{C}$  corresponds to a minimum detectable power of  $10^{-16}$  watt. The method of calibrating using a variable temperature resistive load is described.

Seventy Years (70+1!) of Microwave Thermal Radiation Measurement



# R.H. Dicke (1916-1997)

<https://www.aip.org/history-programs/niels-bohr-library/oral-histories/4572>



“Then it just occurred to me, one day, that you could build a sensitive radiometer, if you used a wide band and synchronously switched the antenna between some radiation source and some internal heat source, with just some heat source of some kind. If the bandwidth was wide enough, you could, using this synchronous detection technique and averaging in time, get quite good sensitivity that way.” R.H. Dicke to M. Harwit

# Intermezzo: Nyquist & Johnson

*M. Longair, Theoretical Concepts in Physics, CUP*

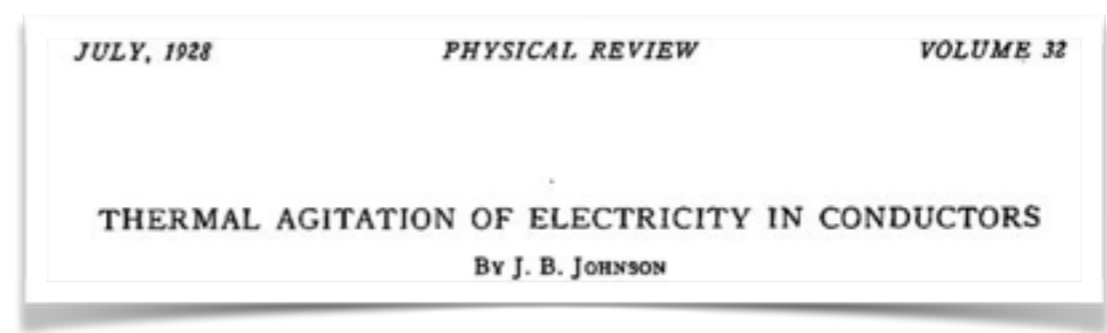
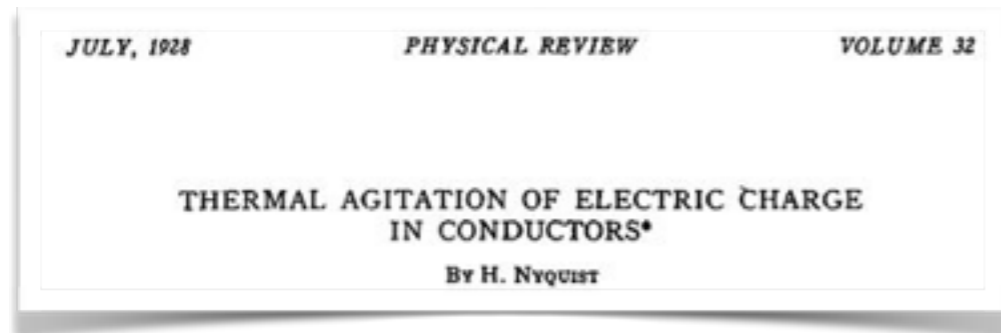

Une résistance  $R$ , dans un réseaux microondes à l'équilibre thermodynamique (à la temperature  $T$ ), parfaitement adaptée à ligne de transmission, rayonne une puissance spectrale  $P_\nu$

$$P_\nu = \frac{h\nu}{e^{h\nu/k_B T} - 1}$$

- ➔ Un corps noir 1D!
- ➔ Connexion thermodynamique - théorie de réseaux

$$h\nu/k_B T \ll 1 \Rightarrow P_\nu \simeq k_B T$$

# La temperature d'antenne

Rayleigh-Jeans ( $h\nu \ll k_B T$ )

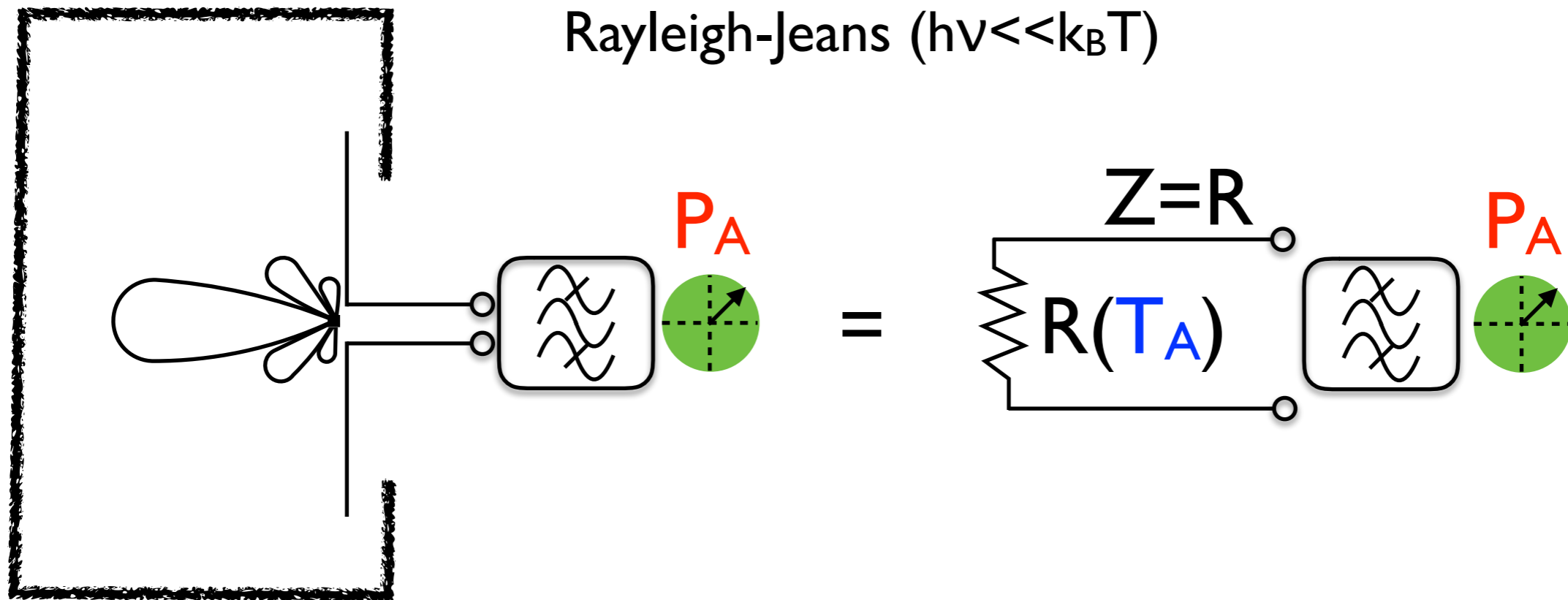

$$B_\nu \quad A\Omega \quad \Delta\nu \quad = \quad T_A \quad k_B\Delta\nu$$

$$T_A = \frac{P_A}{k_B\Delta\nu}$$

# La température de bruit d'un récepteur...

Rayleigh-Jeans ( $h\nu \ll k_B T$ )

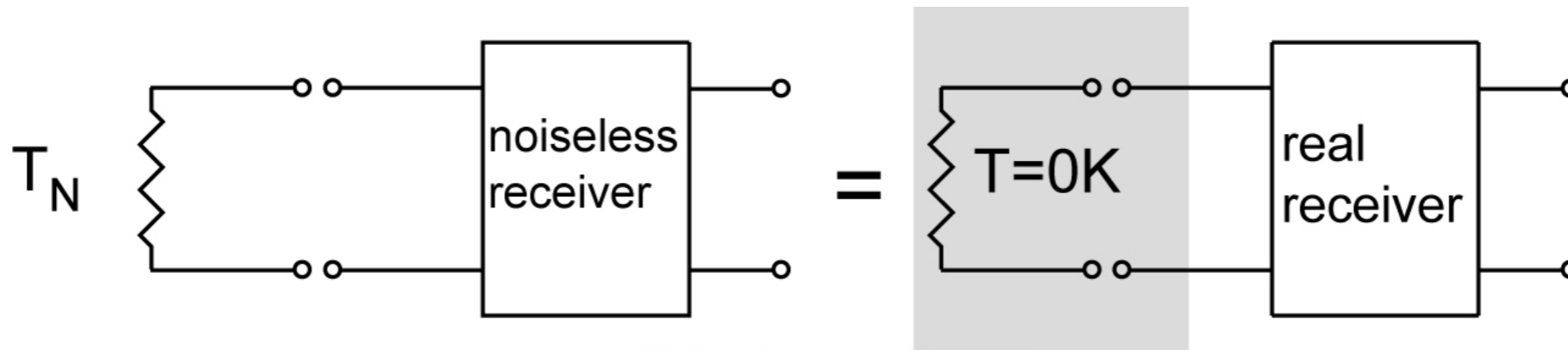

$$T_N = \frac{P_{rec}}{k_B \Delta\nu}$$

Typ: amplification  $10^{10}$ : plusieurs étages nécessaires

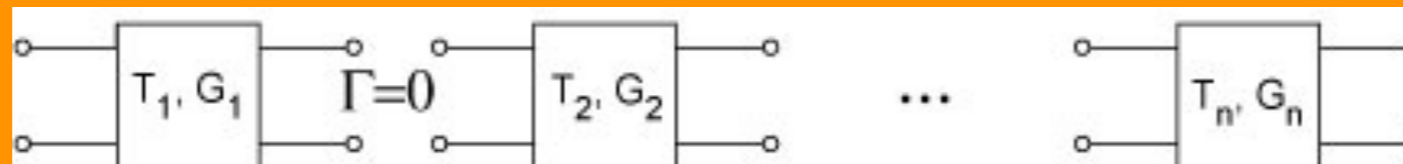

$$G = G_1 G_2 \dots G_n$$

$$T_N = T_{N1} + T_{N2}/G_1 + T_{N3}/G_1 G_2 \dots$$

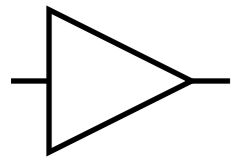

# Principes de detection coherente

*B.Partridge, 3K: the Cosmic Microwave Background, CUP*  
*Burke & Graham-Smith, An Introduction to Radio Astronomy, CUP*

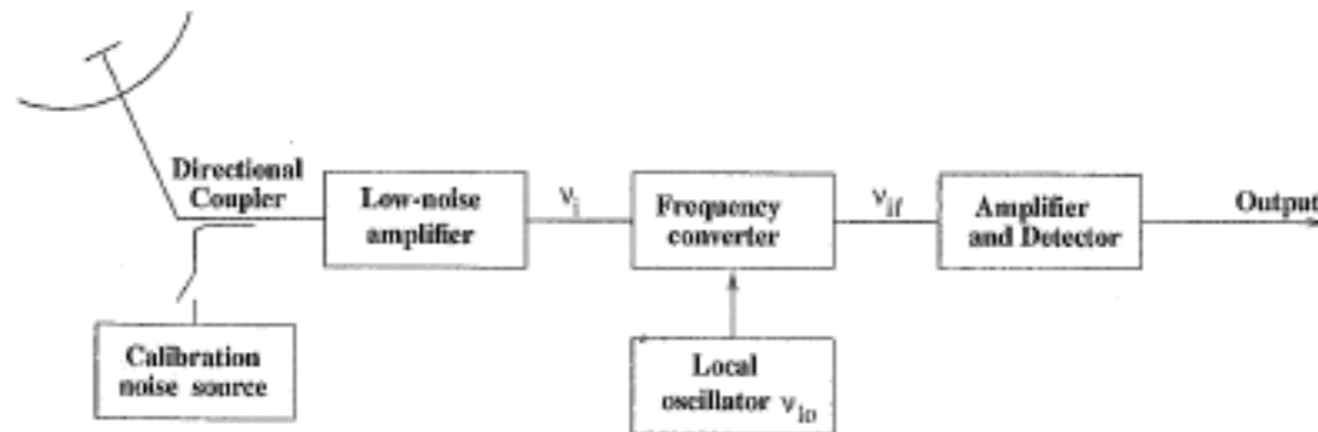

Propriétés:

1. Amplification avant la détection => avec  $P_{out} = G P_{in}$
2. Phase des signaux préservée
3. Possibilité de transposer le signal à basse fréquence

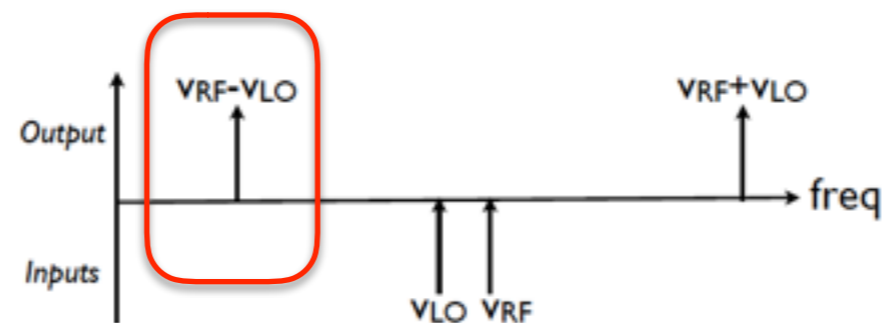

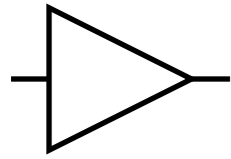

# La sensibilité d'un radiomètre (formule de Dicke)

W.H. Press, *Flicker Noises in Astronomy and Elsewhere*, *Comm. Astrophys.*, 1978

$$T_{sys} = T_A + T_N \quad \sigma = \frac{1}{\eta} \frac{T_{sys}}{\sqrt{\Delta\nu \times n\tau}}$$

Example:  $\eta=0.5$ ,  $T_{sys}=60\text{K}$ ,  $\Delta\nu=4\text{ GHz}$ ,  $n\tau=10\text{ sec}$   
 $\Rightarrow \sigma = 6.0 \times 10^{-4}\text{K}$ ,  $\text{NET} = 1.9 \times 10^{-3}\text{K}\sqrt{\text{s}}$ ,  $\text{NEP} = 3.7 \times 10^{-17}\text{W}/\sqrt{\text{Hz}}$

Mais avec le bruit "1/f" (instabilité de gain, etc.) les performances du récepteur peuvent dégrader rapidement. E.g. la variance du signal augmente avec les temps d'intégration!

blanc

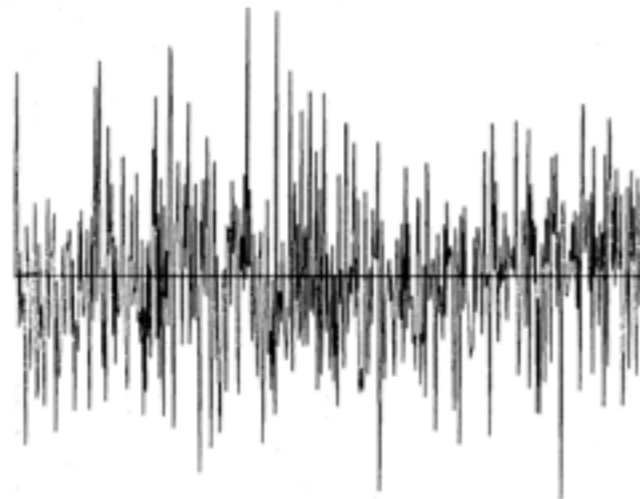

blanc+ 1/f

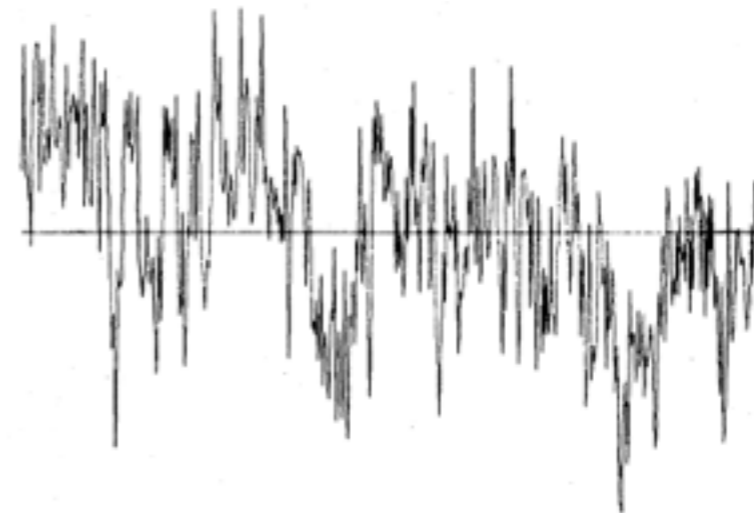

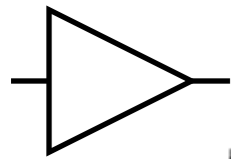

# Le Dicke switching: enjoy white noise!

Burke & Graham-Smith, *An Introduction to Radio Astronomy*, CUP

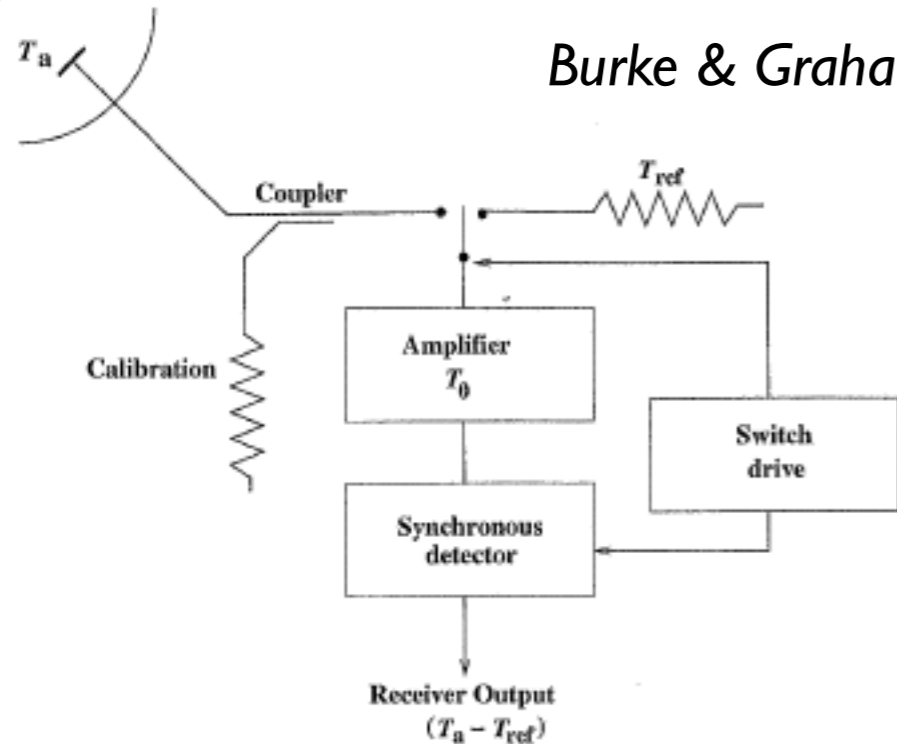

$$\sigma = T_{sys} \sqrt{\frac{1}{\eta^2 \Delta\nu \times n\tau} + \left(\frac{\Delta G}{G}\right)^2} \text{ e.g. instabilité de gain}$$

1. choisir la fréquence de modulation

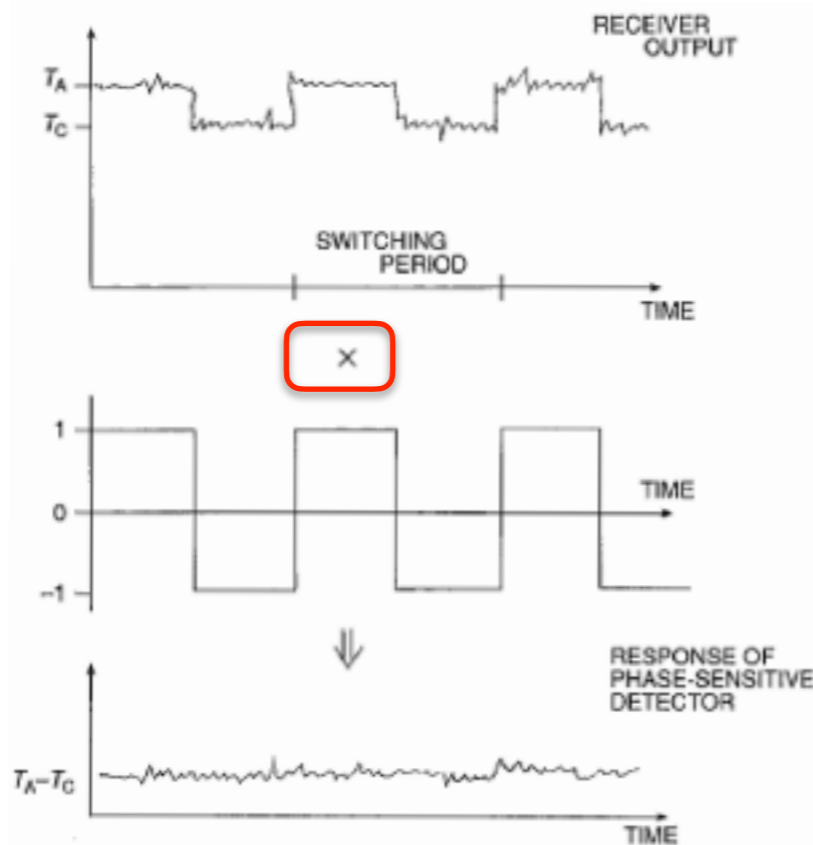
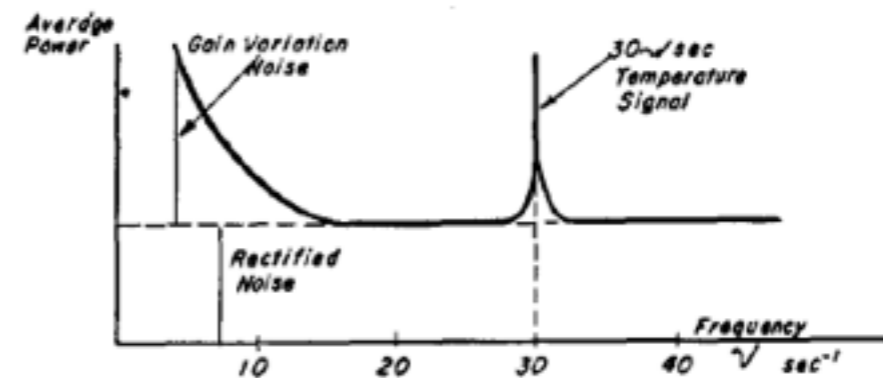

2. Equilibrer le deux portes

$$\sigma = T_{sys} \sqrt{\frac{1}{\eta^2 \Delta\nu \times n\tau} + \frac{(T_A - T_{ref})^2}{T_{sys}^2} \left(\frac{\Delta G}{G}\right)^2}$$

P.S.: Impact decisive du *lock-in* dans la physique expérimentale

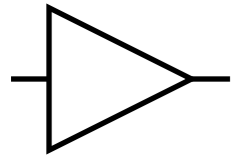

# La Limite Quantique

Caves' theorem (Phys.Rev. D, 26 n.8, 1982)

- Un problème d'optique quantique (une explication brillante en E.Wright, New Ast 1999). Impossible déterminer avec une précision arbitrairement grande les deux composantes du champs électrique en quadrature.
- Le principe de **Heisenberg**

a linear amplifier with gain  $G$  adds a noise number  $A$  (number of photons) such that

$$A \geq \frac{1}{2} |1 - G^{-1}|$$

$$T_N = \frac{h\nu}{k_B \ln(1 + A^{-1})} \xrightarrow{G \rightarrow \infty} T_N \cong \frac{h\nu}{k_B}$$

\*Typiquement **0.5 K/GHz** (en Radio Astronomie). Mais les modes B...

\*La Limite Ultime. Je peux refroidir mon récepteur à 0K...sans résultats.



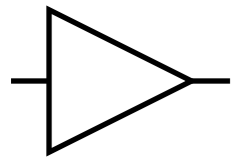

# COBE DMR (Nobel 2006, G. Smoot, J. Mather)

## COBE DIFFERENTIAL MICROWAVE RADIOMETERS: INSTRUMENT DESIGN AND IMPLEMENTATION

G. SMOOT,<sup>1</sup> C. BENNETT,<sup>2</sup> R. WEBER,<sup>3</sup> J. MARUSCHAK,<sup>3</sup> R. RATLIFF,<sup>3</sup> M. JANSSEN,<sup>4</sup> J. CHITWOOD,<sup>3</sup> L. HILLIARD,<sup>3</sup>  
 M. LECHA,<sup>3</sup> R. MILLS,<sup>3</sup> R. PATSCHKE,<sup>3</sup> C. RICHARDS,<sup>3</sup> C. BACKUS,<sup>5</sup> J. MATHER,<sup>2</sup> M. HAUSER,<sup>2</sup> R. WEISS,<sup>6</sup>  
 D. WILKINSON,<sup>7</sup> S. GULKIS,<sup>4</sup> N. BOGGESS,<sup>2</sup> E. CHENG,<sup>2</sup> T. KELSALL,<sup>2</sup> P. LUBIN,<sup>8</sup> S. MEYER,<sup>6</sup> H. MOSELEY,<sup>2</sup>  
 T. MURDOCK,<sup>9</sup> R. SHAFER,<sup>2</sup> R. SILVERBERG,<sup>2</sup> AND E. WRIGHT<sup>10</sup>

Received 1989 December 8; accepted 1990 March 12

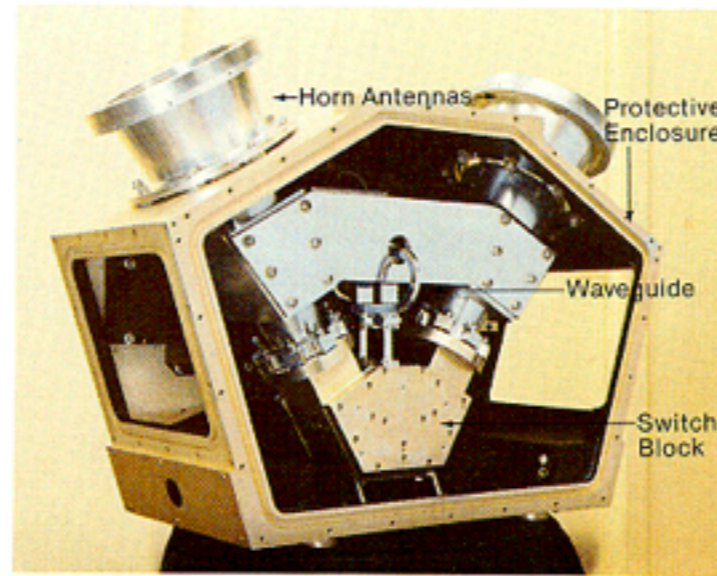
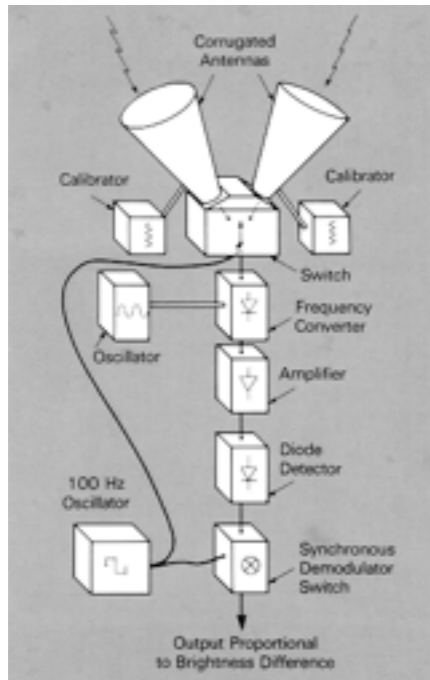

The 9.6 mm DMR receiver partially assembled. Corrugated cones are antennas.

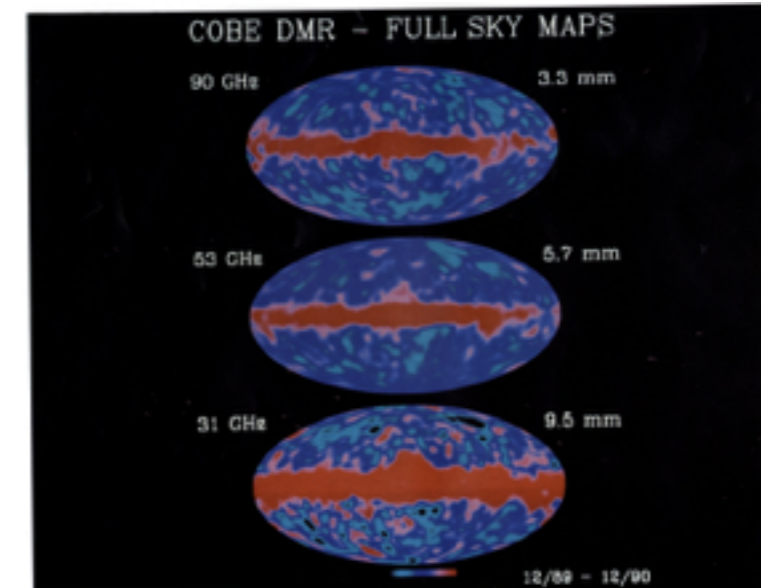

Table 1: Noise Level (per 0.5 sec measurement) for Each DMR Channel

DMR Channel	31A	31B	53A	53B	90A	90B
Flight RMS (mK)	58.27	58.35	23.13	27.12	39.10	30.76

These observations are consistent with inflationary cosmology models. The natural interpretation of the DMR signal is the observation of very large (presently  $\gg 100$  Mpc) structures in the universe which are little changed from their primordial state ( $t \ll 1$  s). These structures are part of a power-law spec-



# Principes de detection incoherente

credit: M.Piat

- Thermal detector
  - Macroscopic system
  - Measure of the heating from the absorption of radiation
  - Thermometer = resistor  $R(T)$
  - Readout:  $R=U/I$
- The best detectors for large bandwidth detection in the wavelength range  $100\mu\text{m}\div 3\text{mm}$ 
  - Cooled to low  $T < 300\text{mK}$
  - Sensitivity limited by photon noise

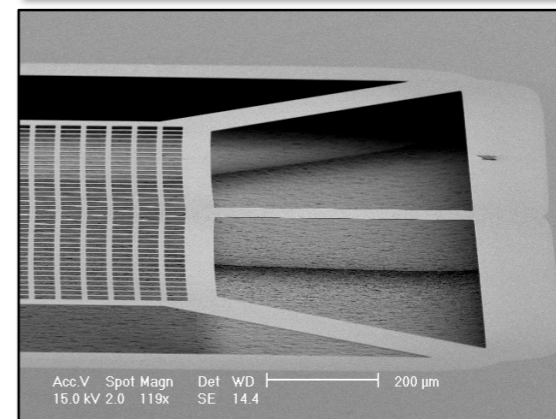
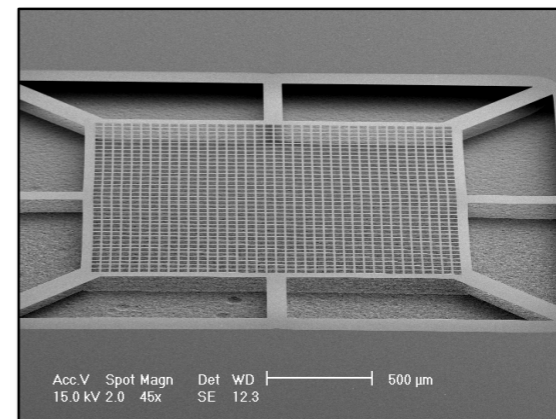
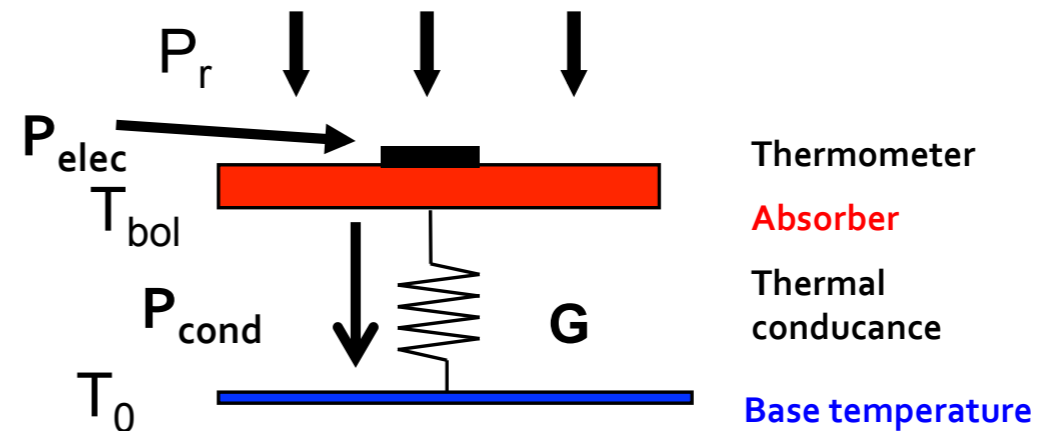

SiN membranes 3x3 mm, 500 nm thickness (IEF Orsay)



# Principes de detection incoherente

credit: M.Piat

## Thermometer

- Parameter:  $\alpha = \frac{T}{R} \frac{dR}{dT}$
- Semi-conductor:  $\alpha \# -5 \rightarrow -10$ 
  - ↳ **Implanted Si**
  - ↳ **Ge NTD (Haller-Beeman)**
  - ↳ **Nb/Si thin film (CSNSM)**
- Superconductor:  $\alpha \# 100 \rightarrow 1000$ 
  - ↳ **Ti**
    - $T_c \approx 400\text{mK}$
  - ↳ **Mo/Cu, Mo/Au...**
    - $T_c$  tuning : proximity effect
  - ↳ **Nb/Si thin film (CSNSM)**
    - $T_c$  tuning : Composition Nb (>12%) vs Si

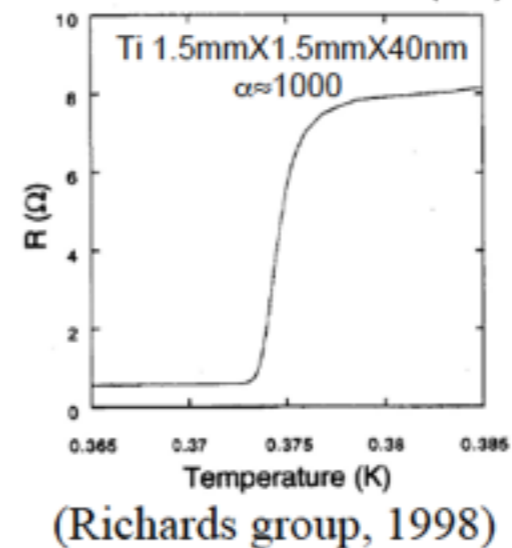
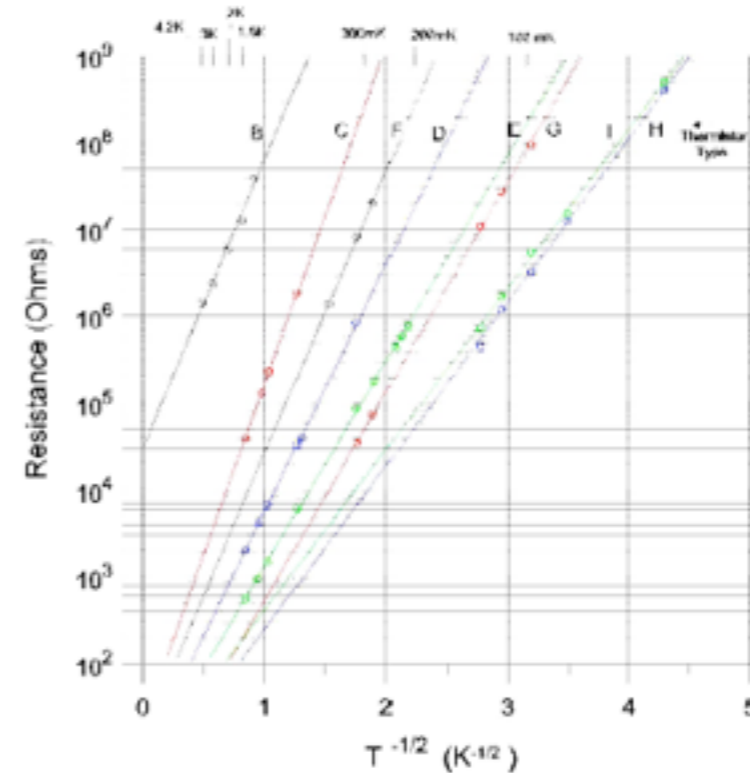

6



# Principes de detection incoherente

credit: M.Piat

Plusieurs sources de bruit limitent les performances de bolomètres, e.g.: le bruit Johnson!

- Johnson noise:

- Electrical resistor R at temperature T

$$PSD_I = \frac{4kT}{R} \left[ A^2 \cdot Hz^{-1} \right]$$

$$NEP_J^2 = \frac{PSD_I}{\mathfrak{R}^2} \left[ W^2 \cdot Hz^{-1} \right]$$

Low temperatures required

- Phonon noise:

- Conductance  $G_d$  at uniform temperature T

$$NEP_{ph}^2 = 4kT^2 G_d \left[ W^2 \cdot Hz^{-1} \right]$$

Responsivity [A/W]

Mais les sources de bruit intrinsèque peuvent être très bien limitées, pour atteindre une condition ideale: la mesure limité par le bruit de photon. Idéalement, le CMB limite une mesure du CMB...

$$NEP_{cmb} \approx h\nu \sqrt{2J} \approx 8 \times 10^{-18} W / \sqrt{Hz} \quad (\text{page 3})$$



# Planck HFI

Table 3. *Planck* performance parameters determined from flight data.

channel	$N_{\text{detectors}}^a$	$\nu_{\text{center}}^b$ [GHz]	mean beam <sup>c</sup>		White-noise <sup>d</sup> sensitivity		calibration <sup>e</sup> uncertainty [%]	faintest source <sup>f</sup> in ERCSC $ b  > 30^\circ$ [mJy]
			FWHM	ellipticity	$[\mu\text{K}_{\text{RJ}} \text{s}^{1/2}]$	$[\mu\text{K}_{\text{CMB}} \text{s}^{1/2}]$		
30 GHz .....	4	28.5	32.65	1.38	143.4	146.8	1	480
44 GHz .....	6	44.1	27.92	1.26	164.7	173.1	1	585
70 GHz .....	12	70.3	13.01	1.27	134.7	152.6	1	481
100 GHz .....	8	100	9.37	1.18	17.3	22.6	2	344
143 GHz .....	11	143	7.04	1.03	8.6	14.5	2	206
217 GHz .....	12	217	4.68	1.14	6.8	20.6	2	183
353 GHz .....	12	353	4.43	1.09	5.5	77.3	2	198
545 GHz .....	3	545	3.80	1.25	4.9	...	7	381
857 GHz .....	3	857	3.67	1.03	2.1	...	7	655

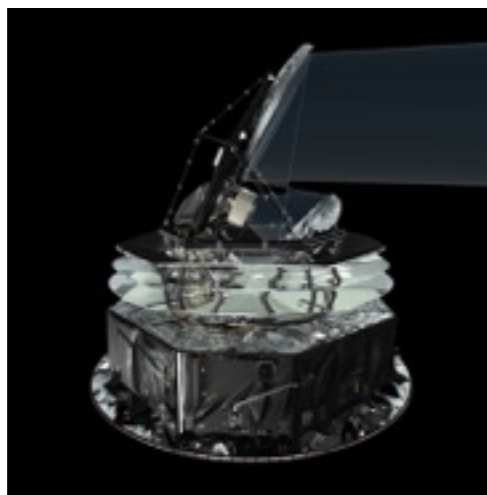

le telescope



les cornets

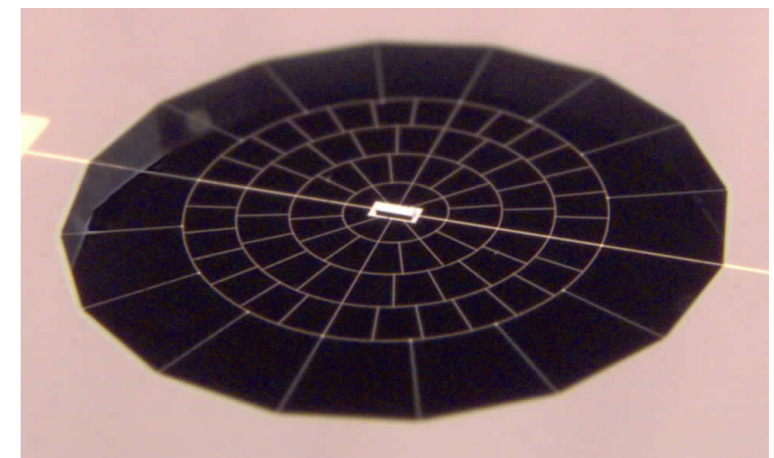

le bolomètre

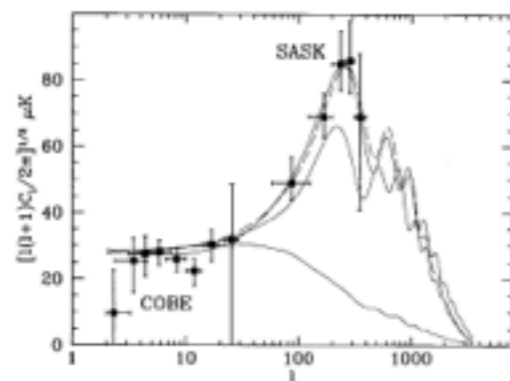

~20 yrs  
→

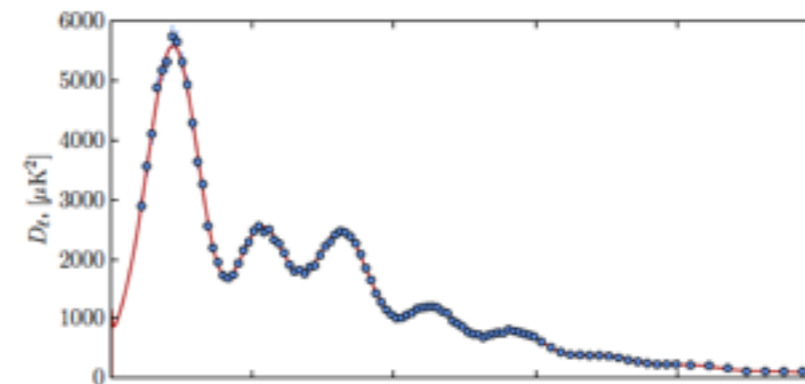



# BICEP II

credit: M.Piat

## Refracting optics focusing on planar antenna arrays

- 1 pixel:
  - 2 orthogonal 12x12 slot antenna phased array
  - Bandpass filter on stripline
  - 2 small TESs (Ti and Al)
- 8x8 pixels per tiles, 4 tiles
- Total of 256 pixels and 512 TESs
  - Time Domain Multiplexing
  - MUX factor = 33

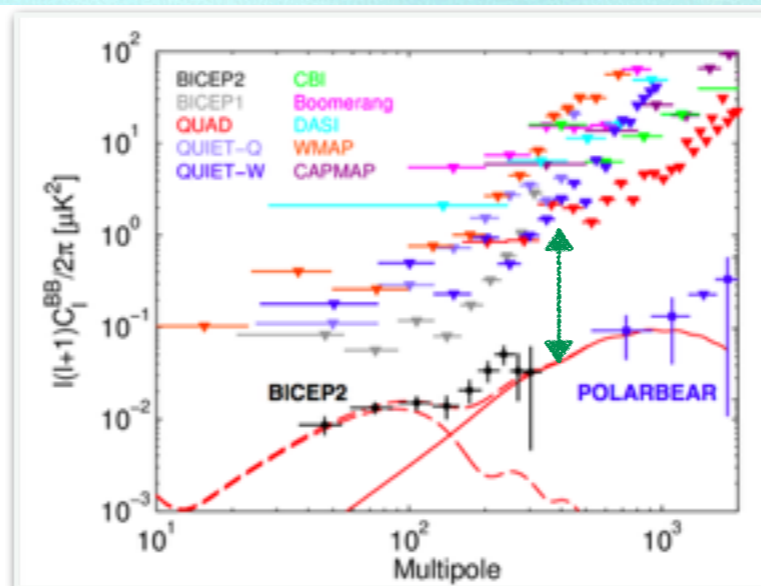
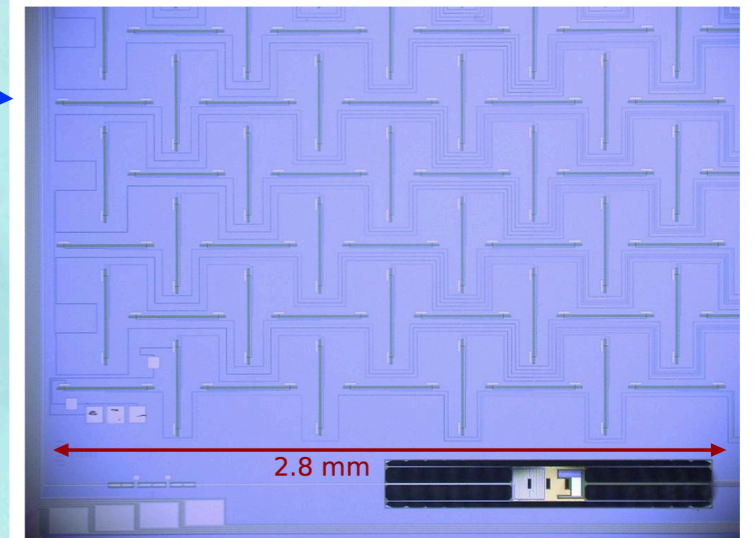
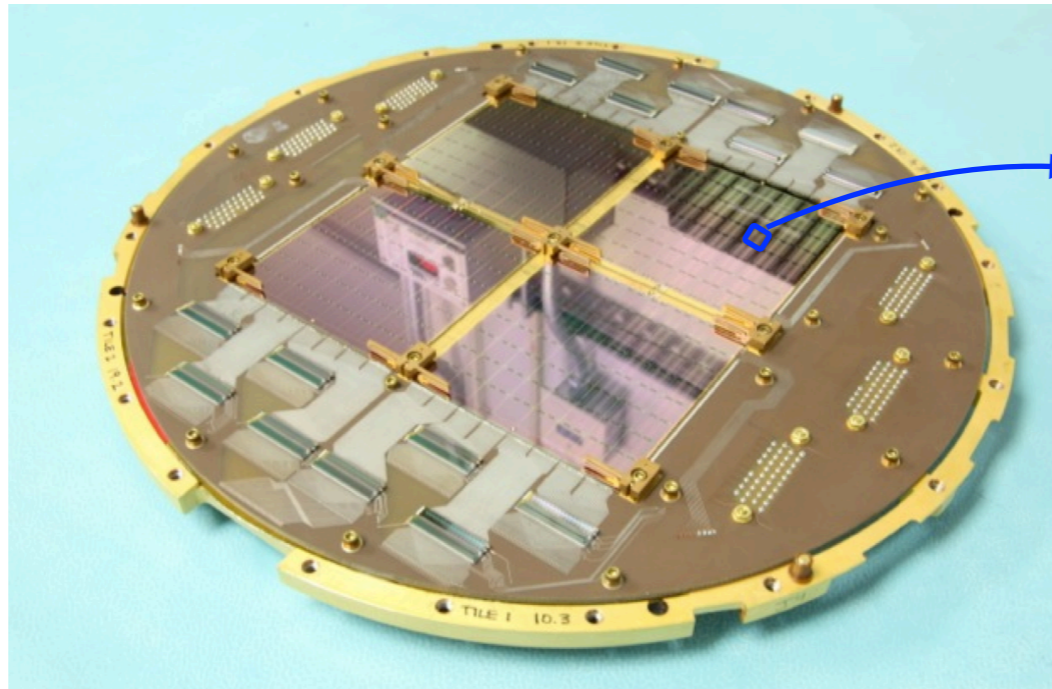

**Introduction des matrices  
des détecteurs  
supraconducteurs dans  
l'observation du CMB**



“[...] my feelings have always been that you start with Idea and not with an apparatus, and the idea, you feel, is sufficiently important to warrant a lot of effort, then you develop whatever apparatus you need to crack it [...].”