

DE LA RECHERCHE À L'INDUSTRIE



Mesurer l'infiniment petit et observer l'infiniment grand



Rencontres d'été de physique de l'infiniment grand à l'infiniment petit 2017 : promotion Lise Meitner

17-27 juillet 2017
Europe/Paris timezone



Basé sur le cours de Stefano Panebianco

Maxence Vandembroucke

06/2017

université
PARIS-SACLAY

Cours 1 : Généralités

- Introduction générale sur l'importance de la mesure
- Qu'est-ce qu'une expérience de physique subatomique ?
- Que veut-on observer à propos d'une particule?
- Architecture générale d'une expérience en physique subatomique

Cours 2 : Les détecteurs à ionisation

- Interaction particule-matière
- Les Détecteurs à ionisations
- L'exemple des détecteurs gazeux

Cours 3 : Exemples d'expériences ?

Cours 1 : Généralités

- Introduction générale sur l'importance de la mesure
- Qu'est-ce qu'une expérience de physique subatomique ?
- Que veut-on observer à propos d'une particule?
- Architecture générale d'une expérience en physique subatomique

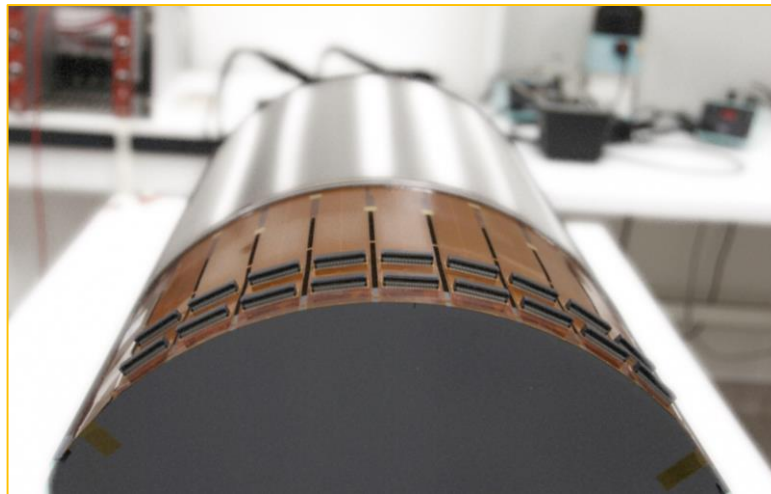

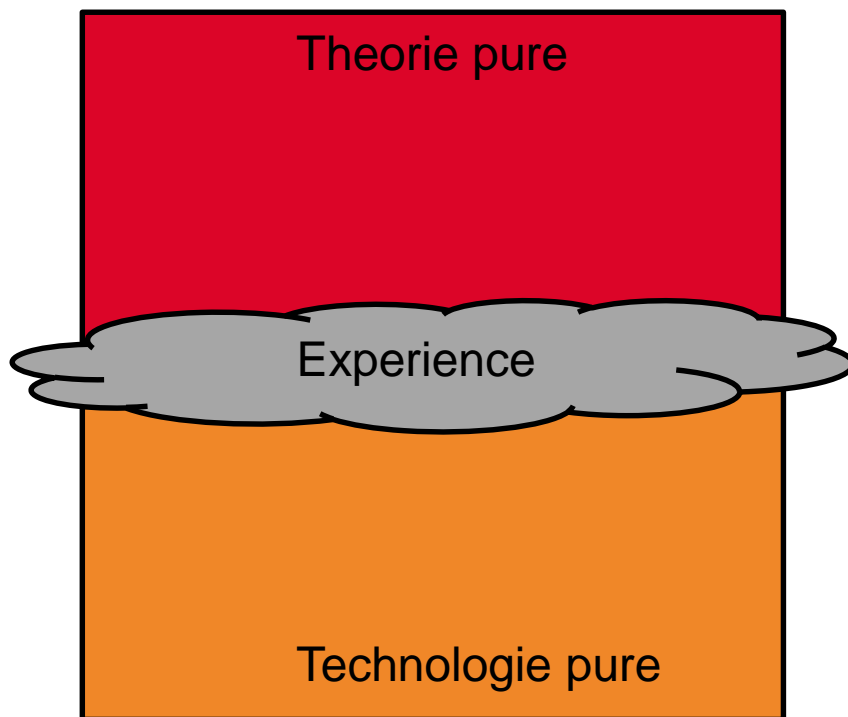

- Théorie
- Construction des Modèles
- Prédiction avec des Modèles
- Simulation d'expérience MC
- Design d'expérience
- Recherche sur les détecteurs
- Electronique/acquisition
- Reconstruction des évènements
- Comparaison avec le MC
- Papier !

Le physicien complet est à la fois proche des interrogations fondamentales, mais aussi des avancés technologiques pour trouver un espace de découverte potentielle

(vision un peu naïve)

MESURER C'EST QUOI ?

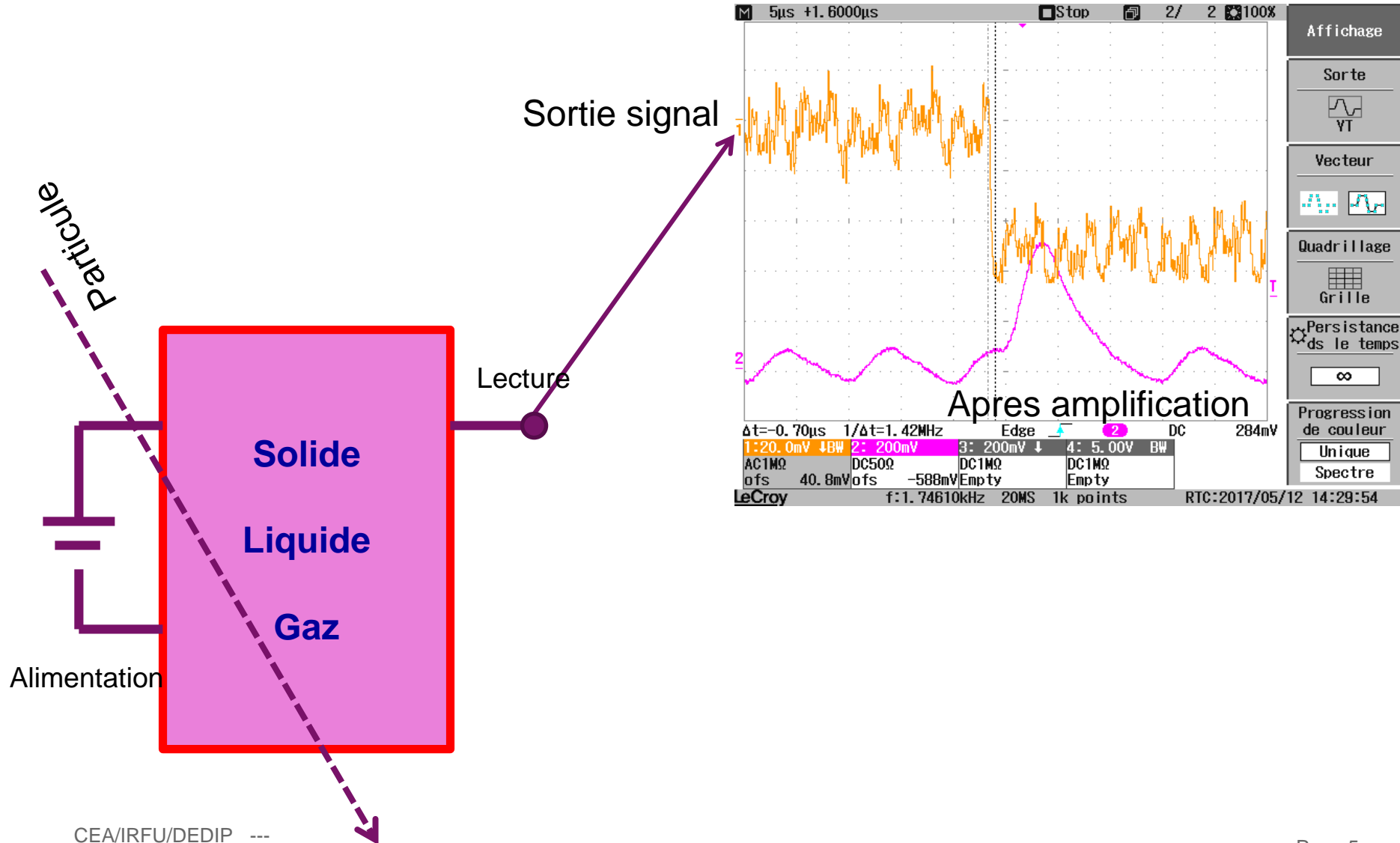

Passage dans la matière d'une particule avec charge électrique

Ex.: un muon ou un proton du rayonnement cosmique

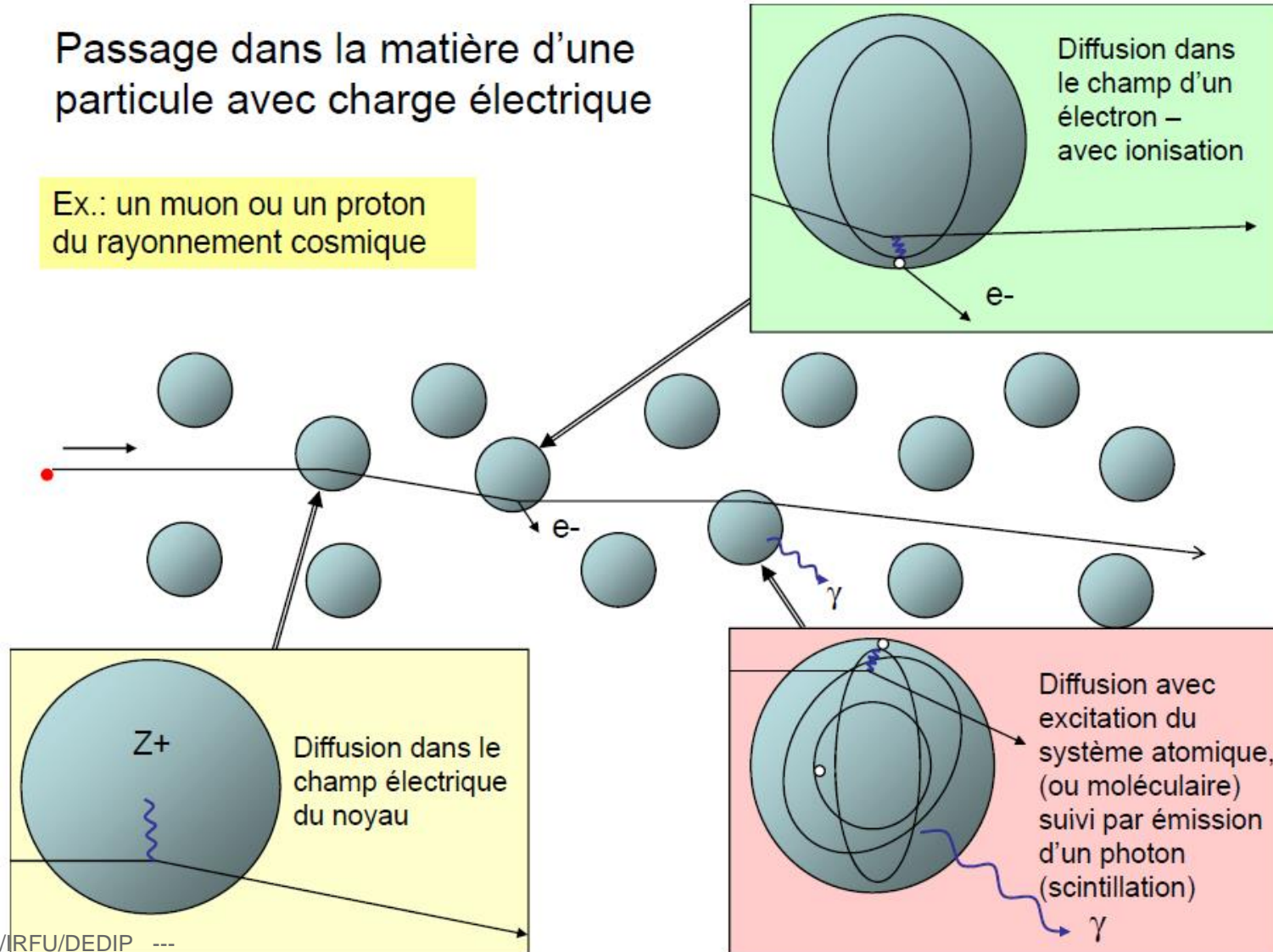

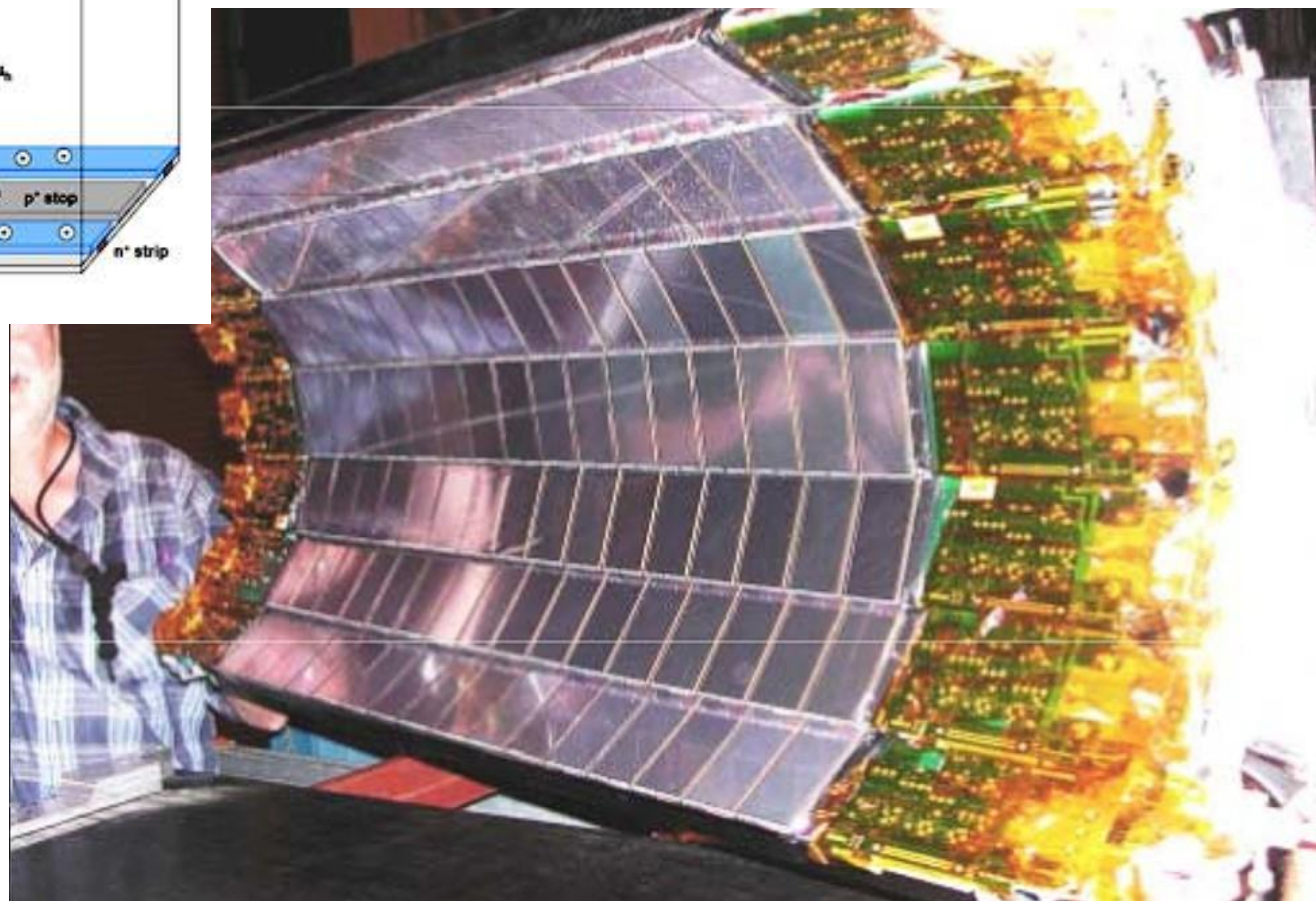
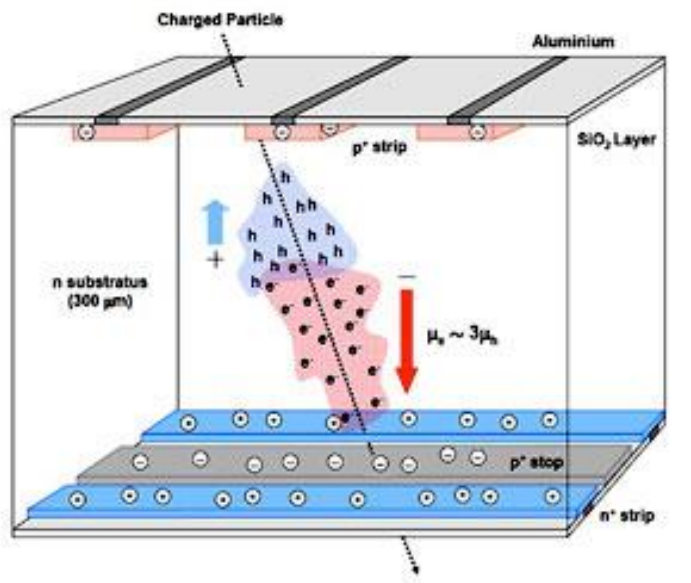

MESURER QUOI ?

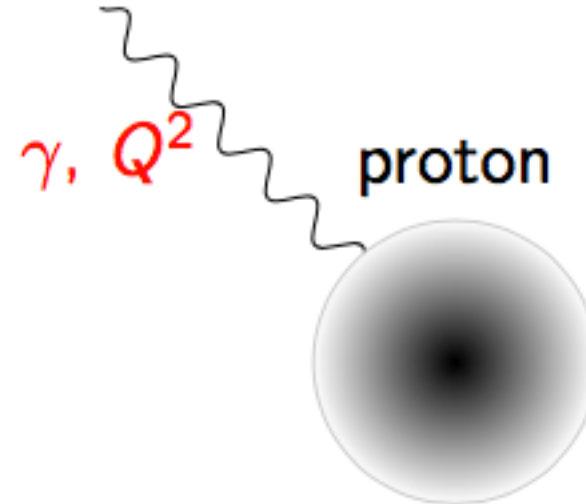
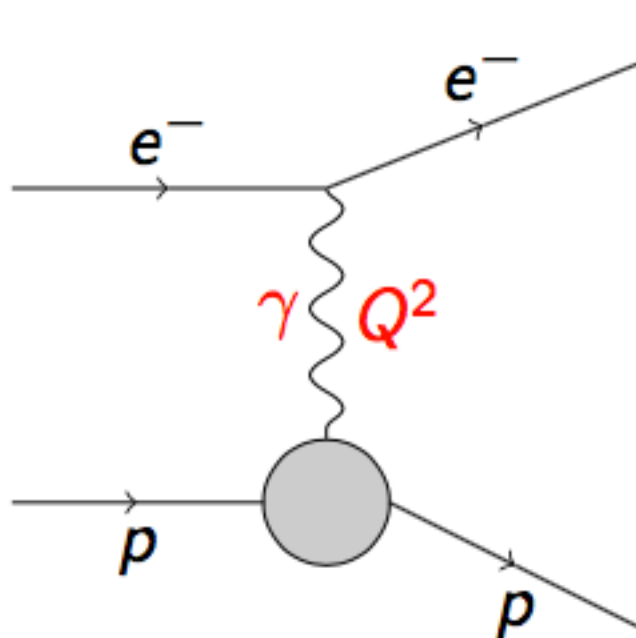

Diffusion élastique.

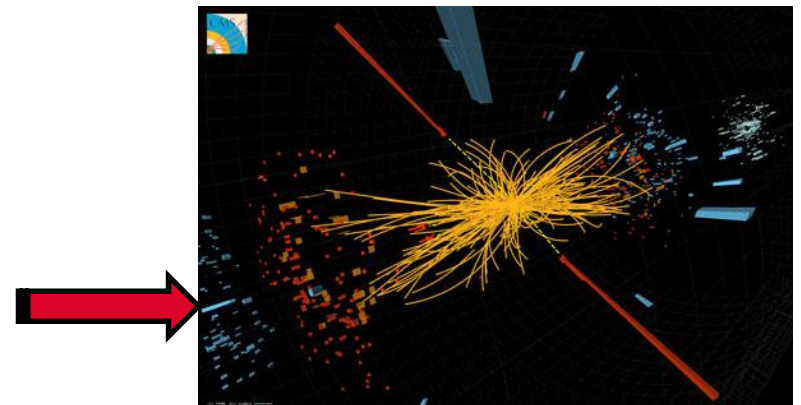

Déterminer la carte d'identité d'une particule :

- QUADRIVECTEUR IMPULSION-ÉNERGIE
- MASSE ET CHARGE (QU'ON REGROUPE SOUVENT SOUS LE NOM DE PID POUR PARTICLE IDENTIFICATION)
- SPIN/PARITÉ (ÉVENTUELLEMENT...)



Mesure de l'impulsion

Mesure de l'impulsion

- Technique de spectrométrie magnétique (ou du B-rho)

$$qvB = mv^2/\rho \quad \rightarrow \quad p_{\perp} = p \cos \vartheta = qB\rho$$

- Technique de temps de vol (TOF pour Time Of Flight)

$$L = v\tau = \beta c\tau = \beta c\gamma\tau_0 = p\tau_0/m$$

Mesure de l'impulsion

- Technique de spectrométrie magnétique (ou du B-rho)
- Technique de temps de vol (TOF pour Time Of Flight)

Mesure de l'énergie

- Calorimétrie
- Perte d'énergie dE/dx

Mesure de l'impulsion

- Technique de spectrométrie magnétique (ou du B-rho)
- Technique de temps de vol (TOF pour Time Of Flight)

Mesure de l'énergie

- Calorimétrie
- Perte d'énergie dE/dx

Mesure de spin et de la parité

- (Pas traitée ici)
- Avec un polarimètre indirectement
- Par sélection

Mesure de la masse et de la charge (PID)

- Combinaison B-rho et TOF
- Combinaison B-rho et dE/dx
- Masse manquante ...
- Direction de la courbure dans un spectromètre magnétique
- Mesure de la perte d'énergie dE/dx qui dépend de la charge
- L'électromètre

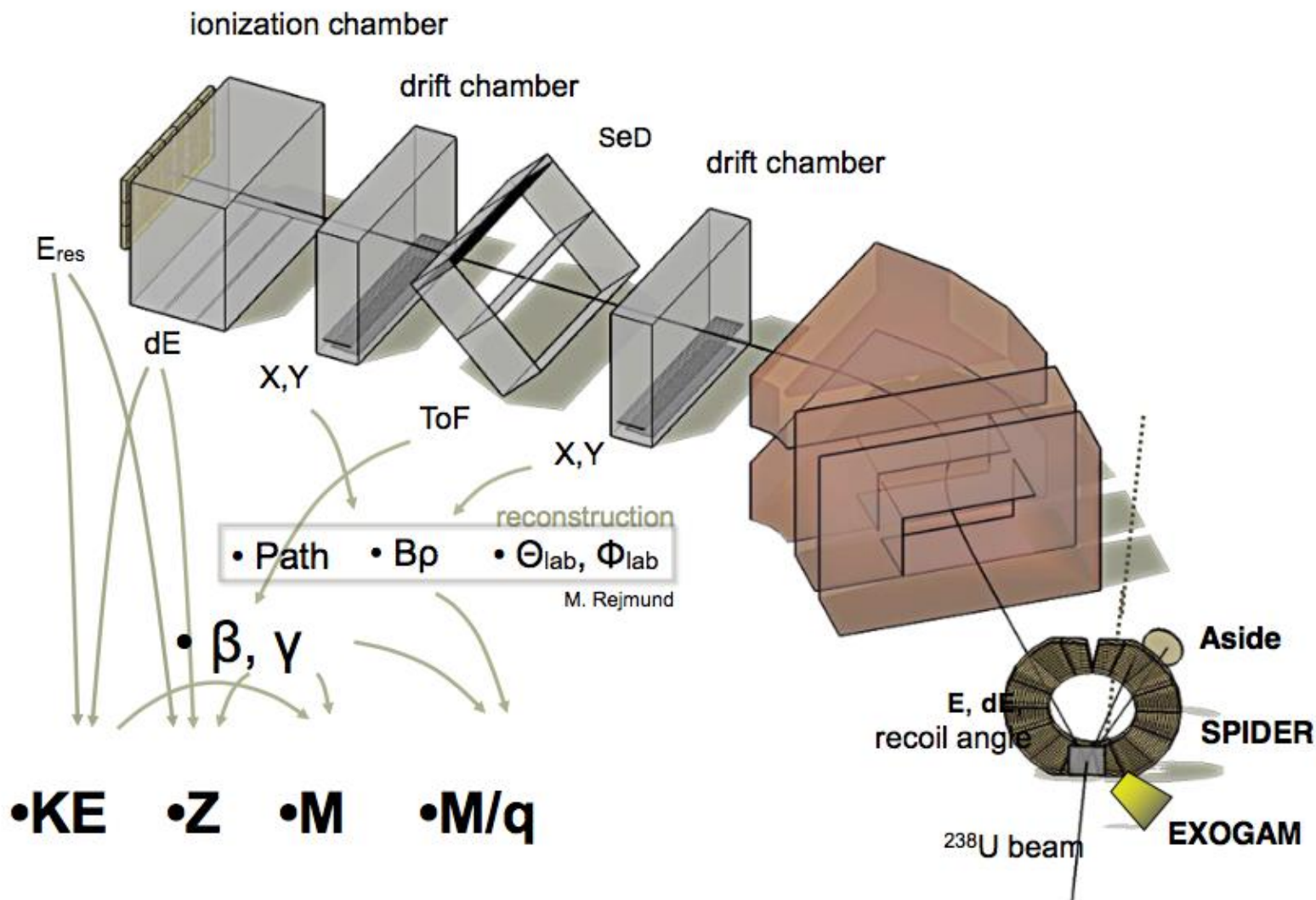

Compact Muon Solenoïd

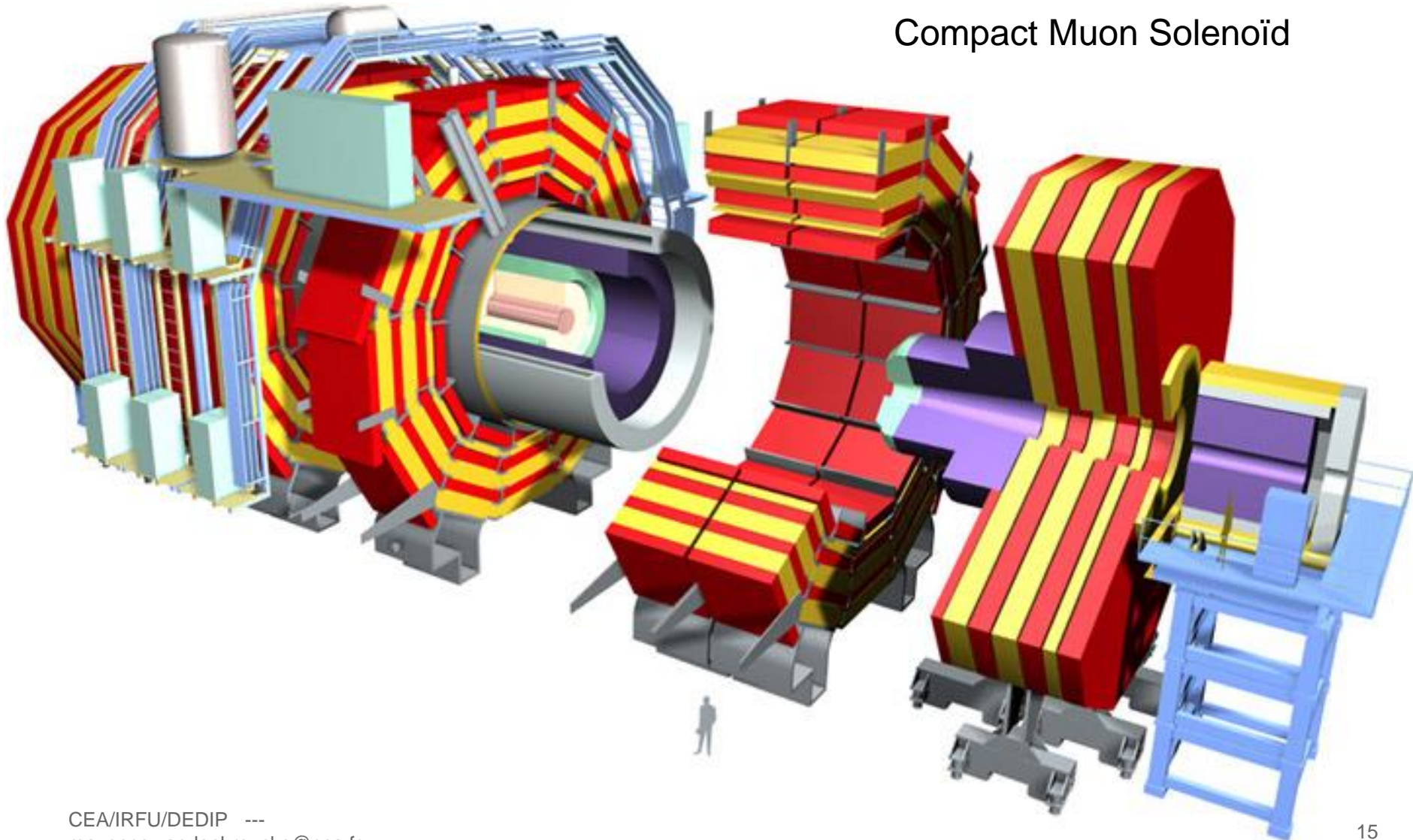

Trajectographe

Calorimètre
électromagnétique

Calorimètre hadronique

Détecteurs à muons

Aimant

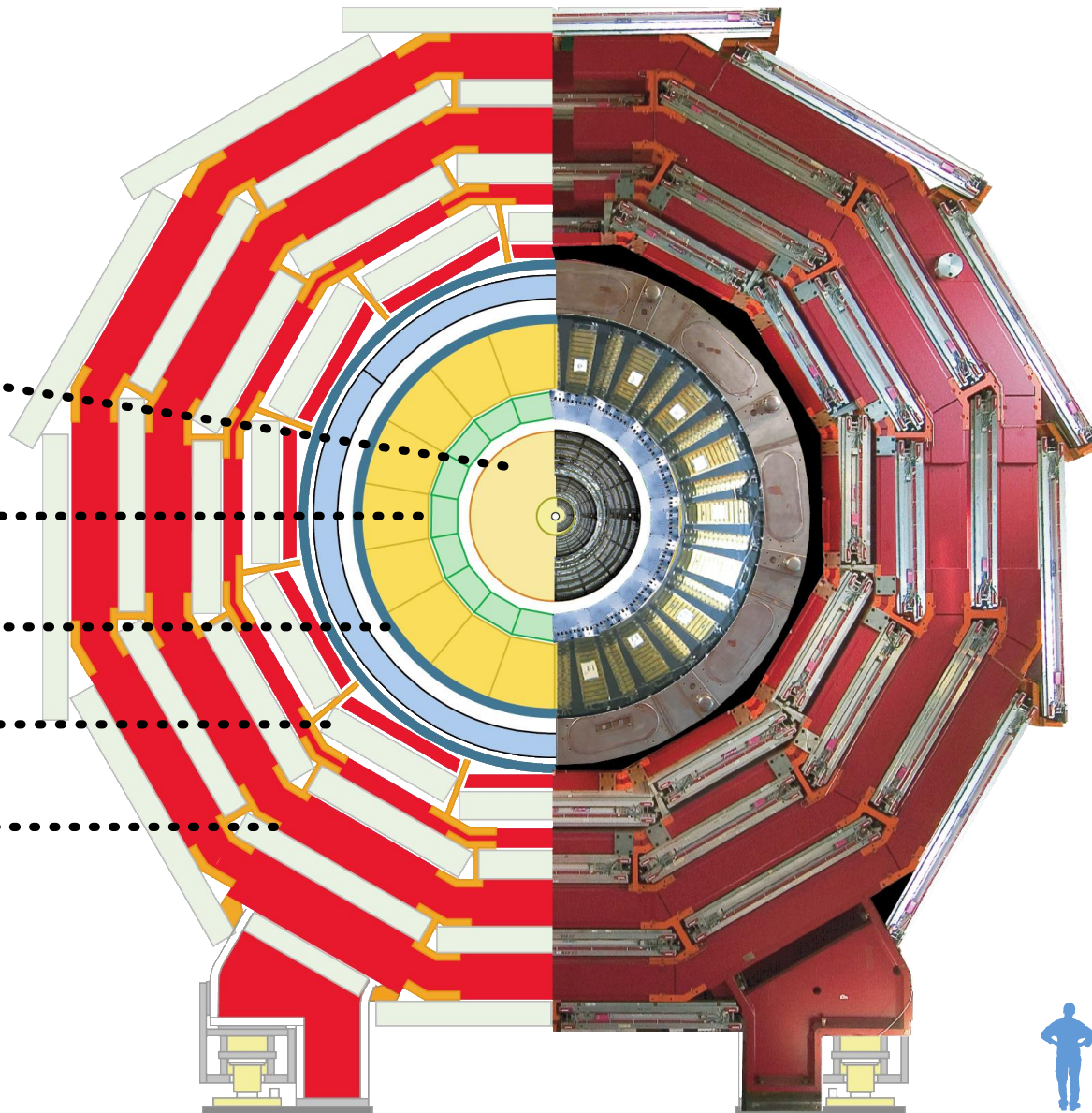

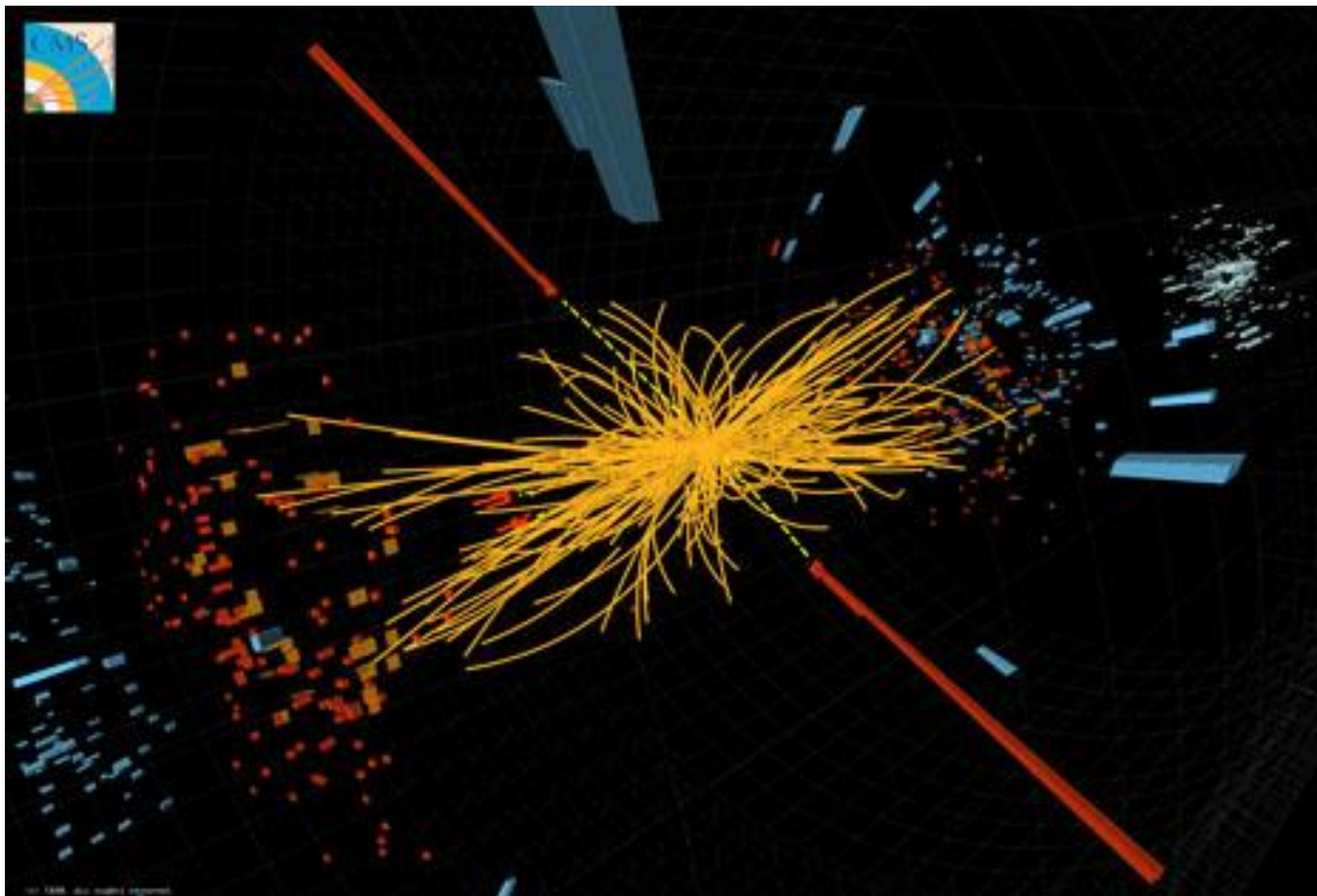

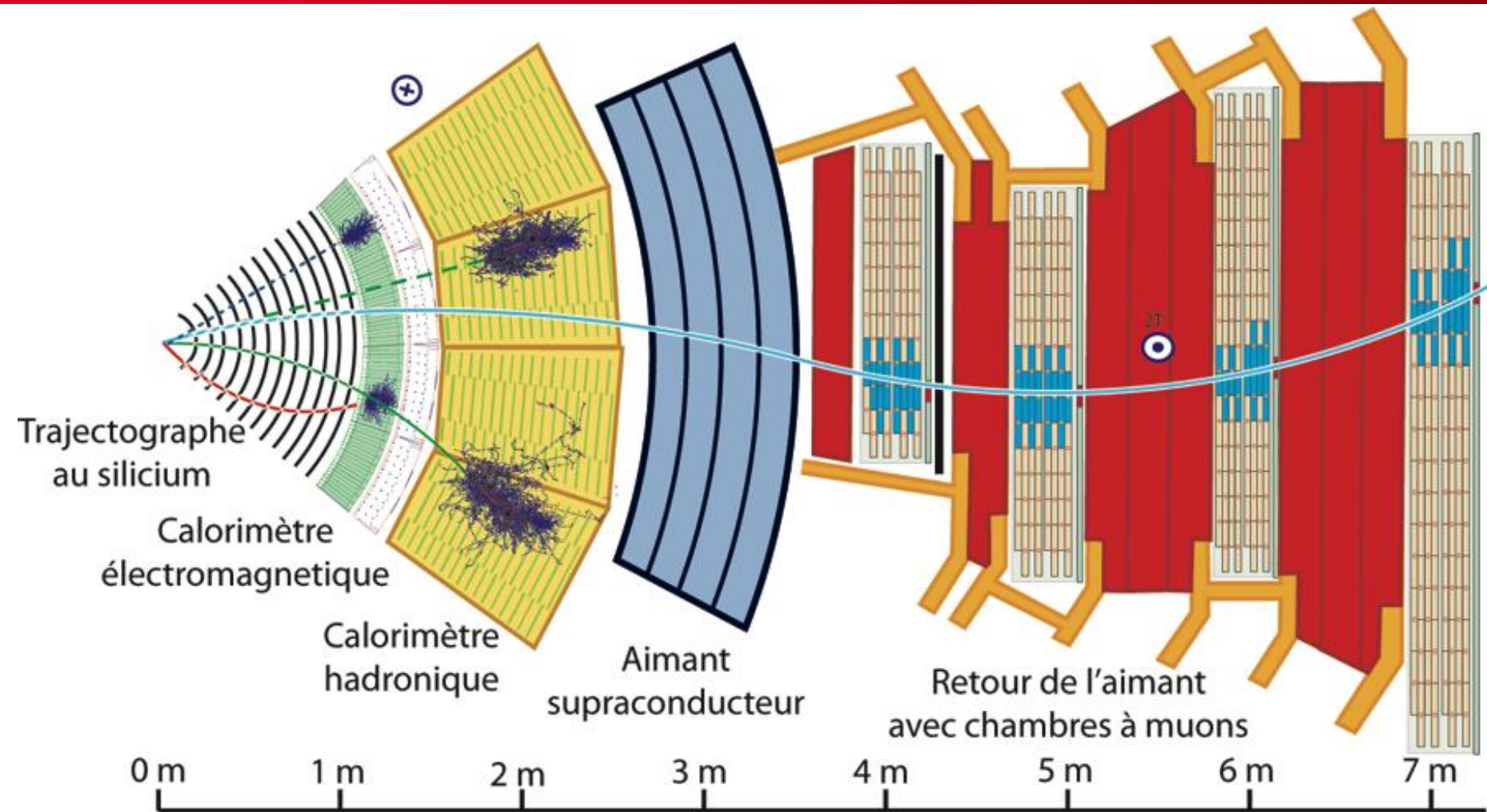

légende :

— Muon

— Électron

— Hadron chargé

- - - Hadron neutre

- - - Photon

W EVENT -> ISOLATED LEPTON

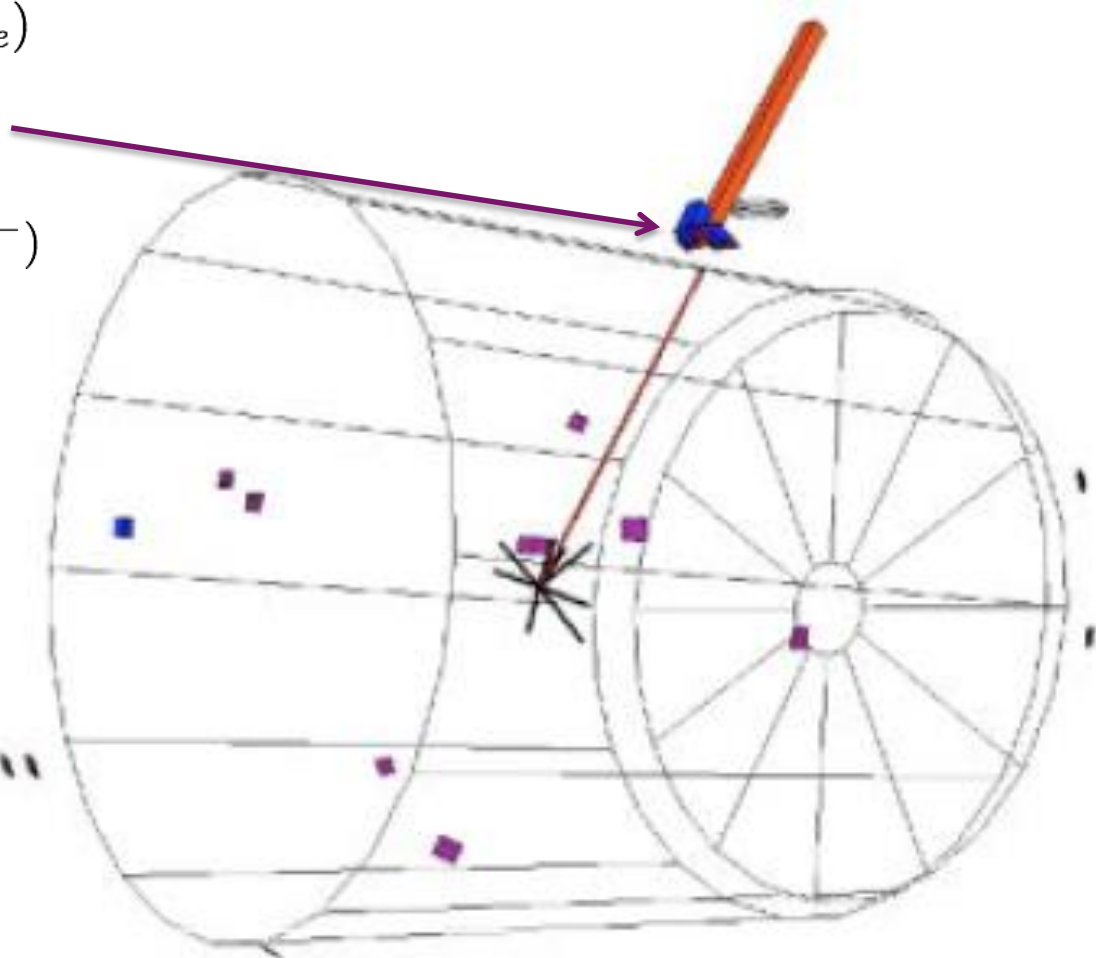
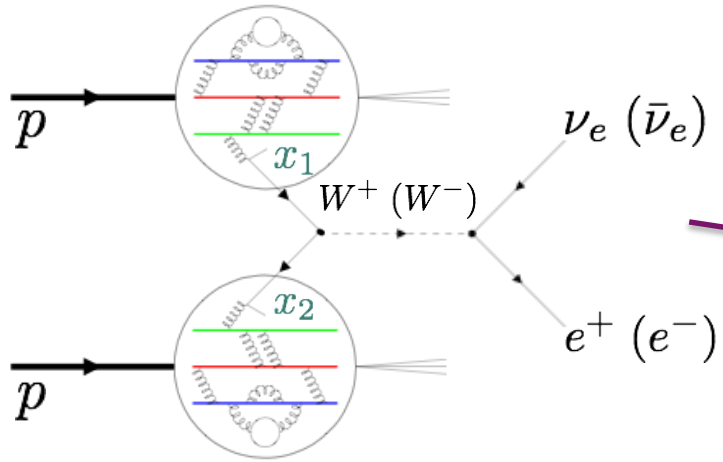

W+/W-

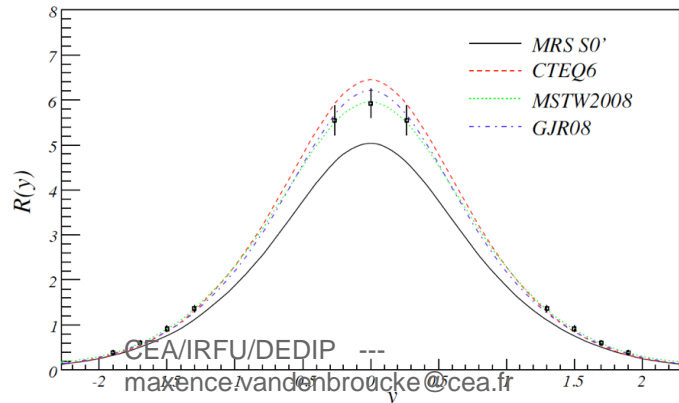

STAR experiment at BNL

17-27 juillet 2017

Rencontres
DE L'INFINIMENT
GRAND
à l'infiniment petit

2017 : Promotion Lise Meitner



Visites de labos,
conférences, débats
Comprendre la physique pour
les élèves de leur laboratoire
sans oublier les élèves
de collège
Mettre l'infiniment petit
dans l'infiniment grand
Applications modernes
Niveau L3

Rencontres d'été de physique de l'infiniment grand à l'infiniment petit 2017 : promotion Lise Meitner

17-27 juillet 2017
Europe/Paris timezone

Cours 2 : Les détecteurs de particules

- Trajectographie :
 - Détecteurs Gazeux
 - Détecteurs au Silicium
- Calorimétrie
- Scintillation



Basé sur les cours de Stefano Panebianco (CEA/IRFU),
et le cours de Werner Riegler (CERN),
Particle Detectors, Second Edition, C. Grupen & B. Shwartz

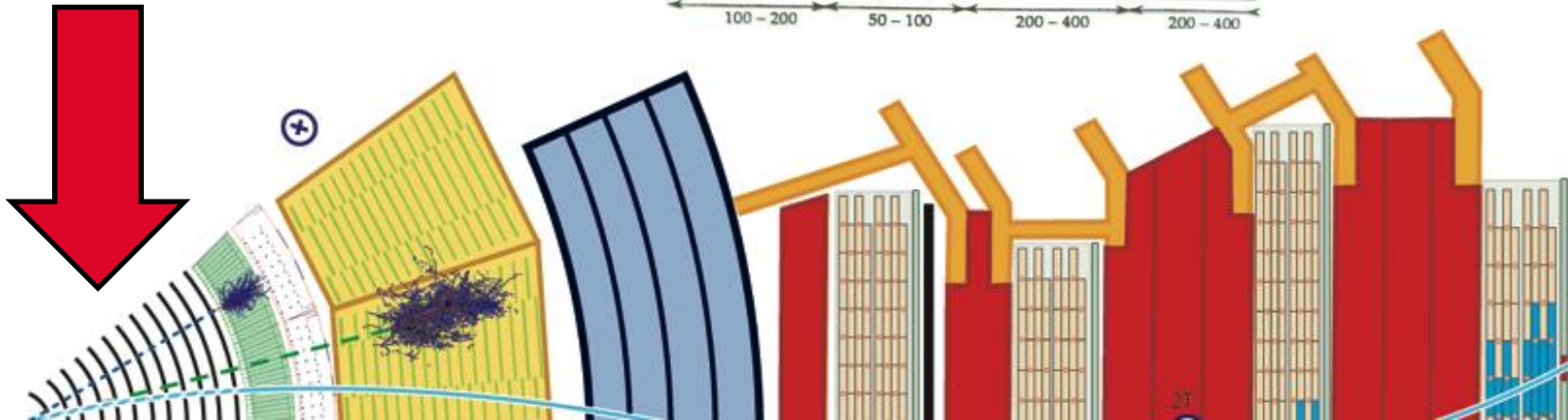
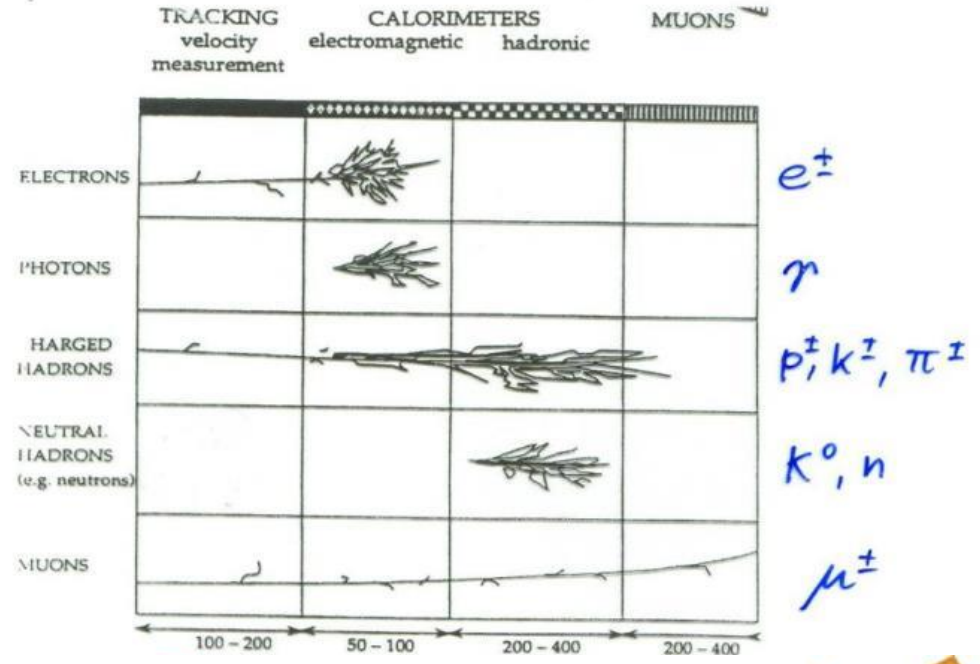

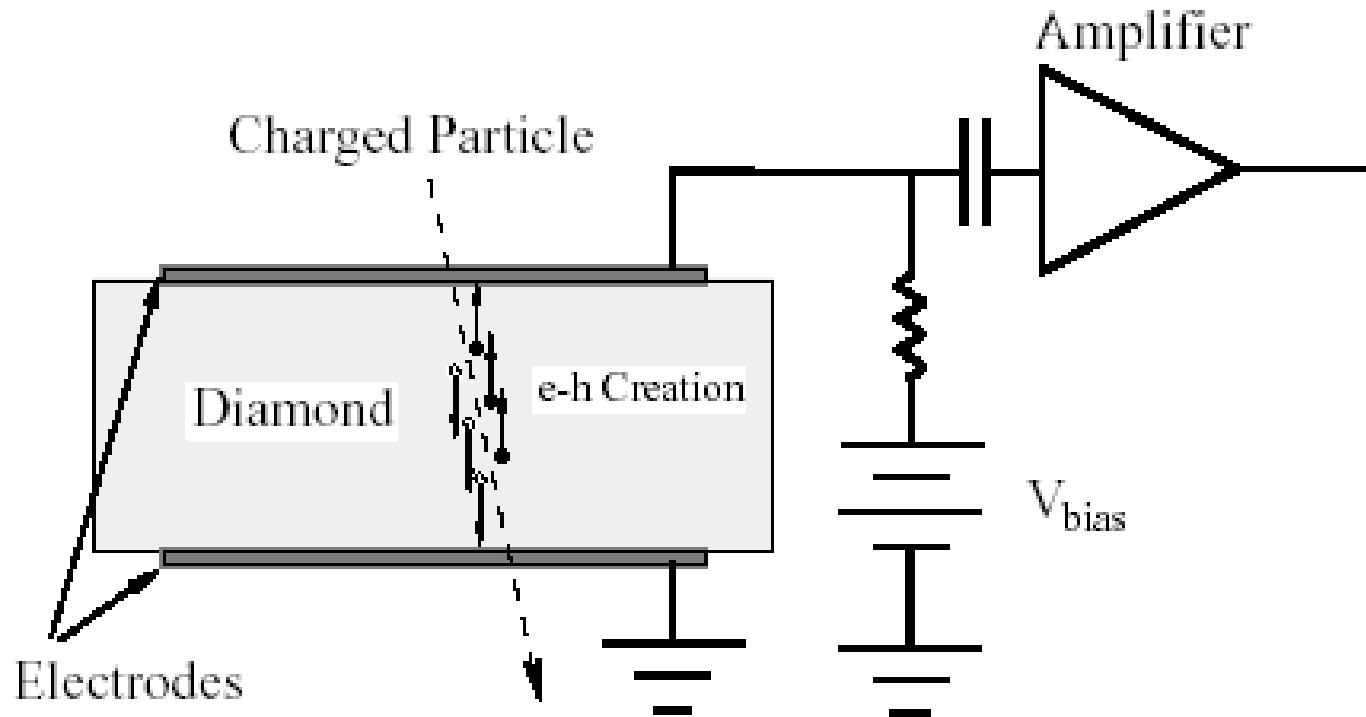

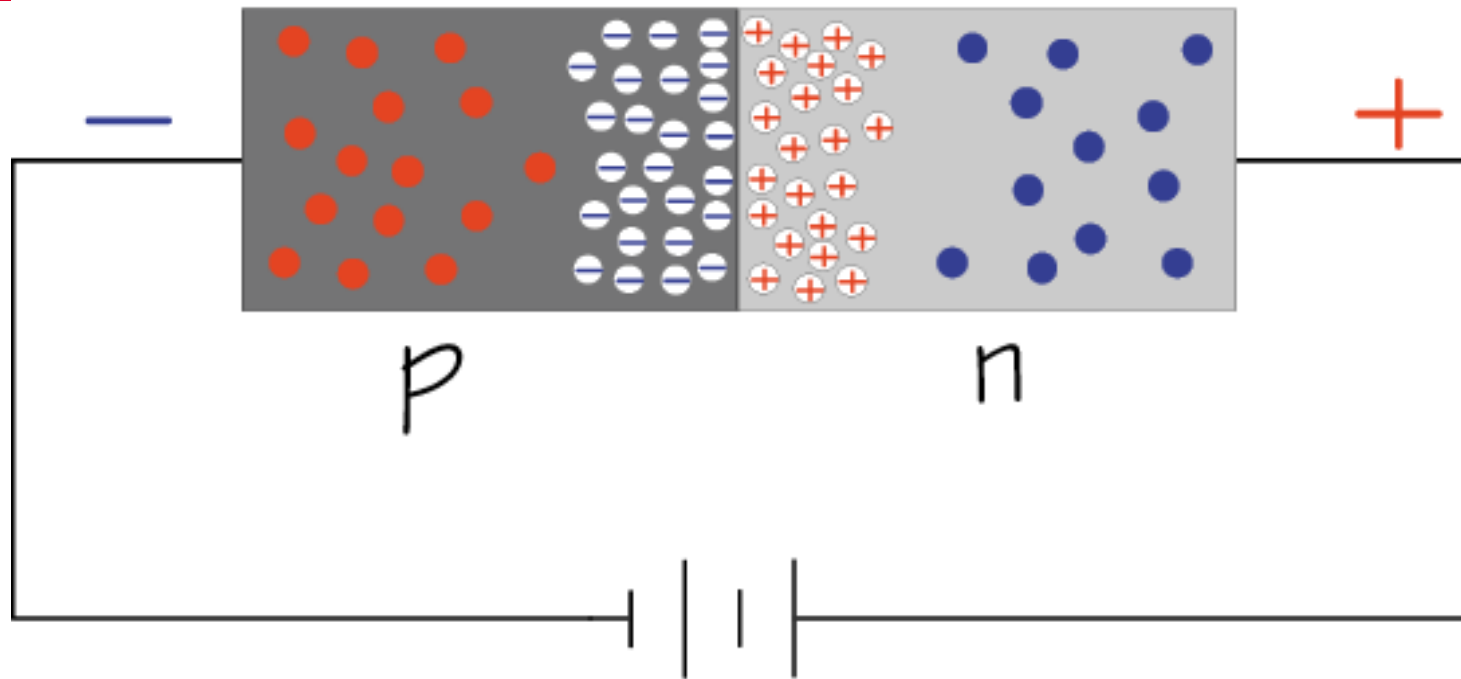

- Electron
- ⊕ Positive ion from removal of electron in n-type impurity
- ⊖ Negative ion from filling in p-type vacancy
- Hole

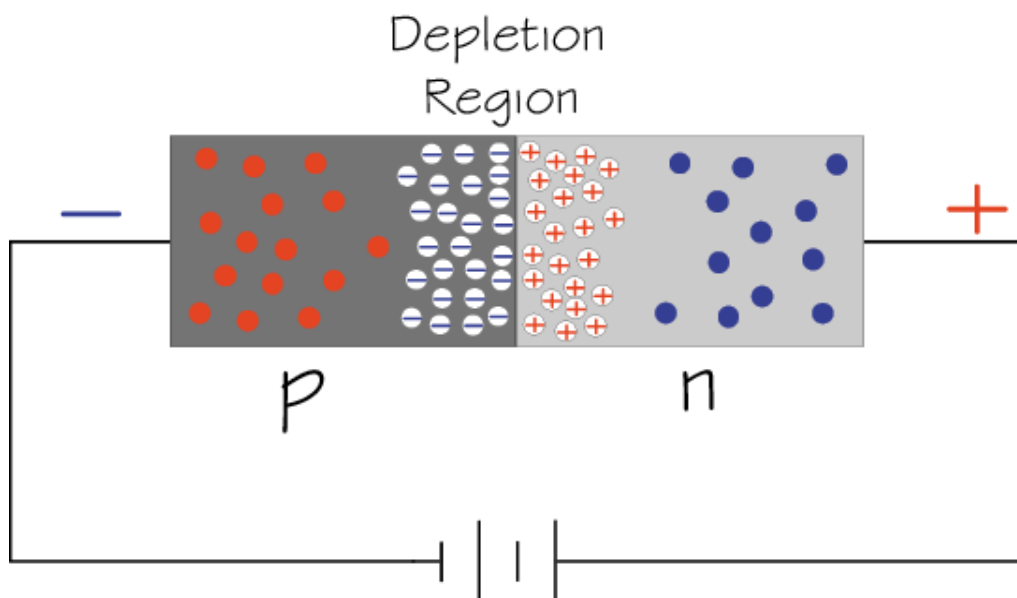

- Electron
- ⊕ Positive ion from removal of electron in n-type impurity
- ⊖ Negative ion from filling in p-type vacancy
- Hole

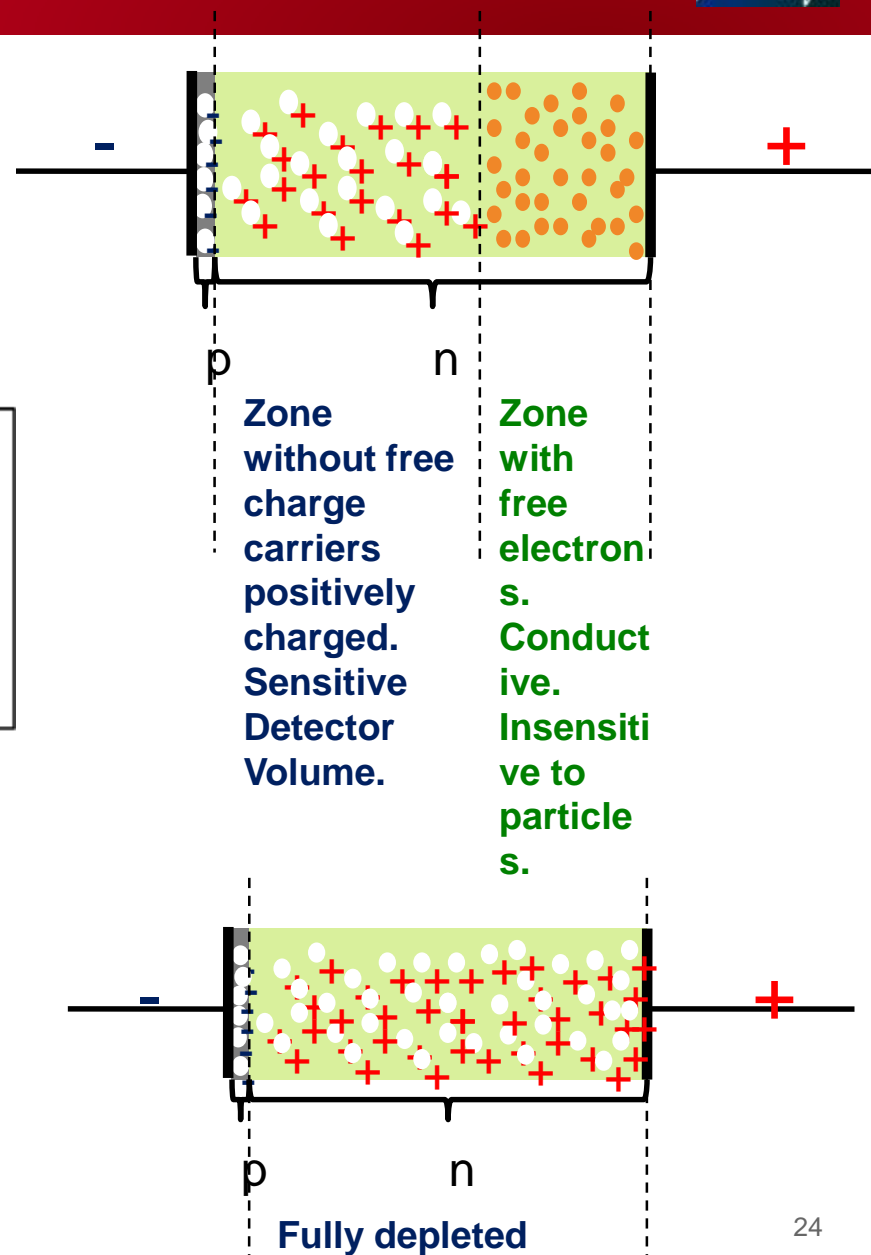

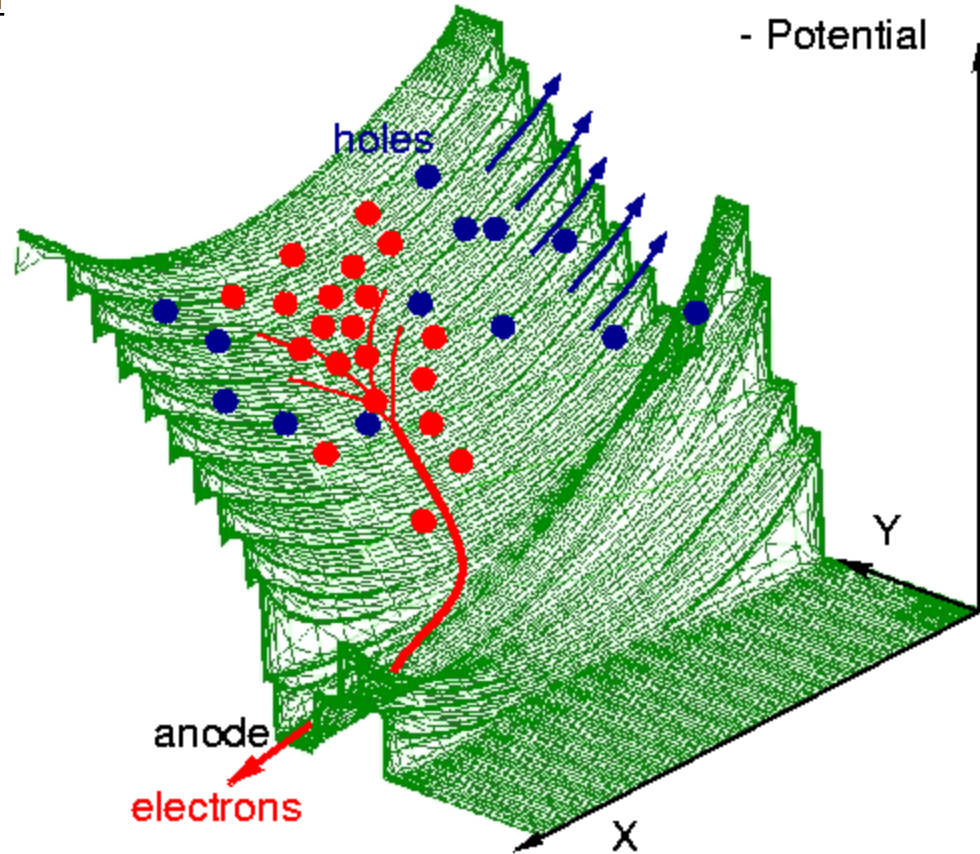
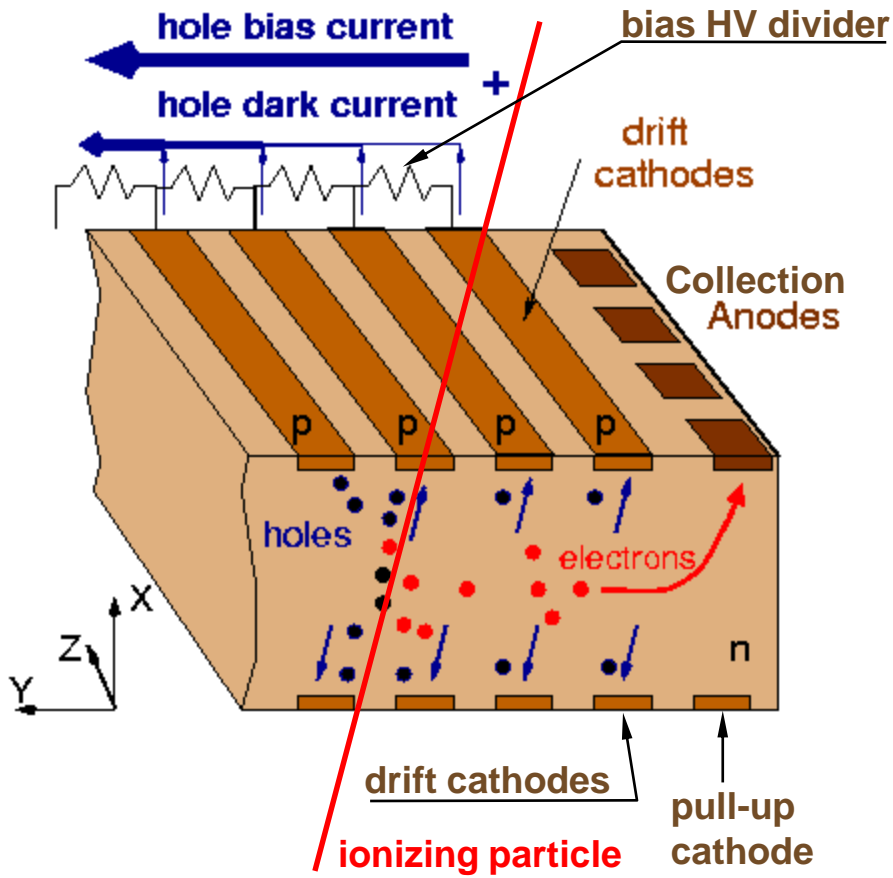

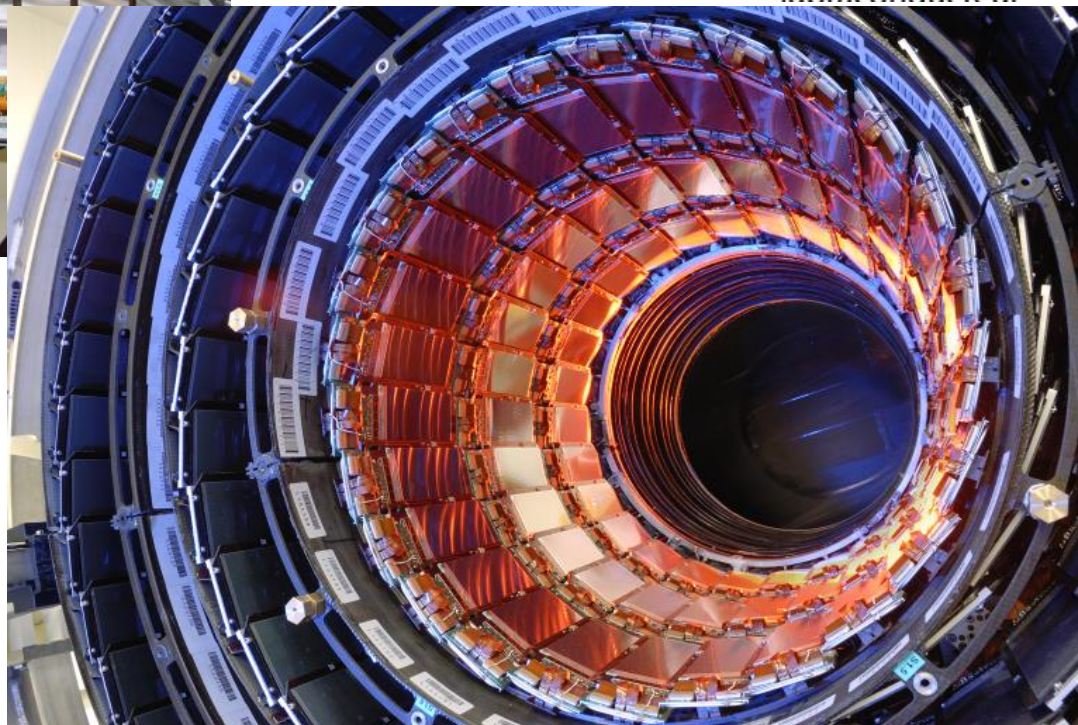
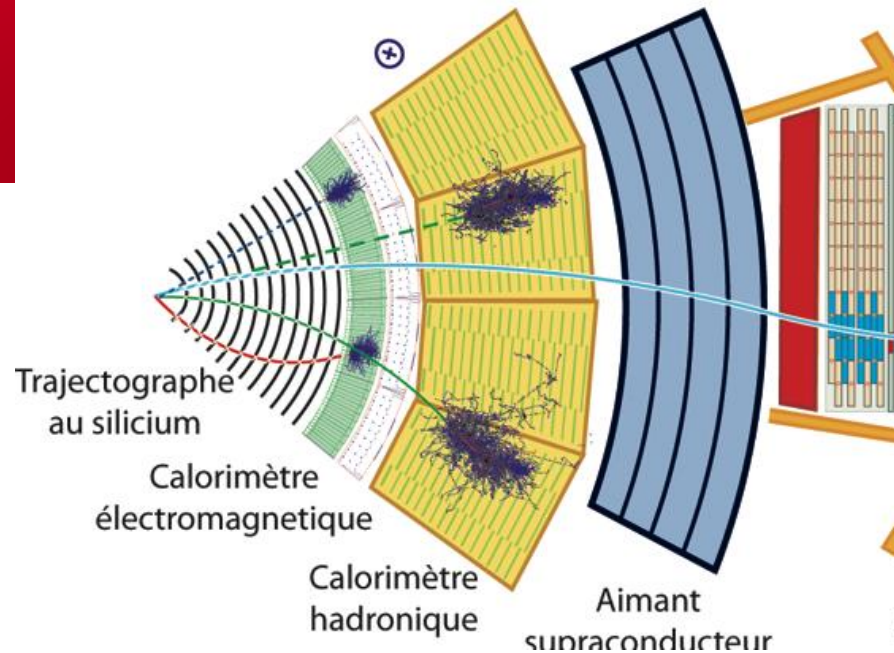

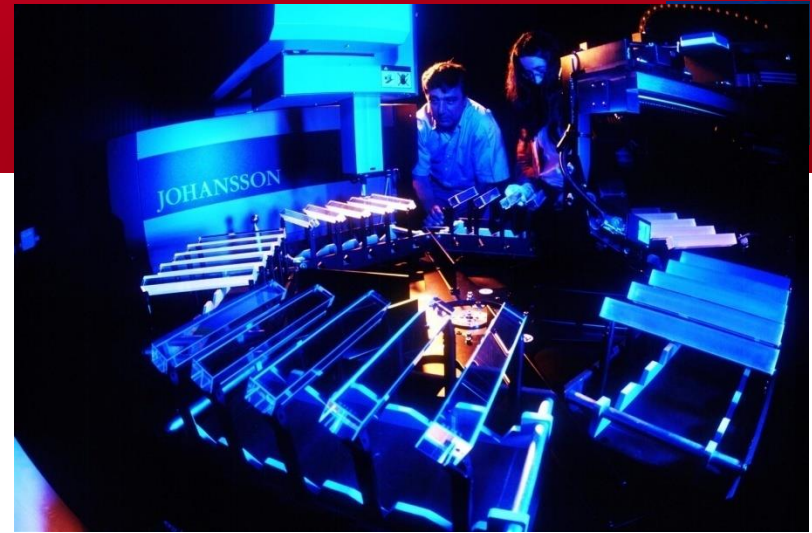

Les Détecteur à base de scintillation

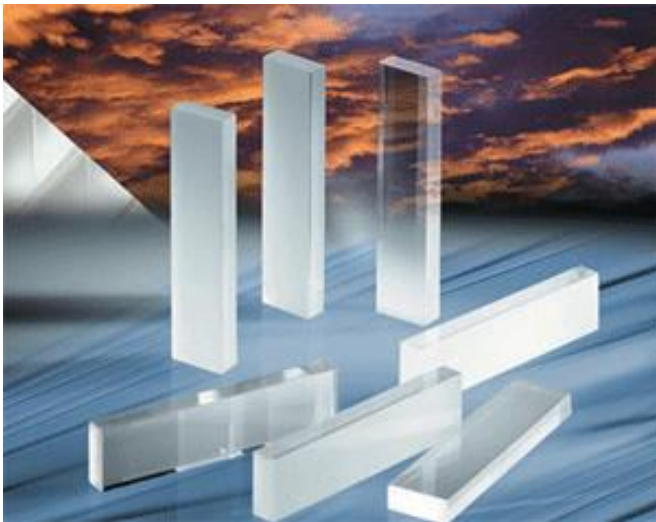

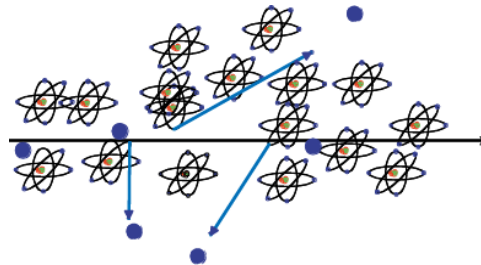

Detectors based on Registration of excited Atoms → Scintillators

Emission of photons of by excited Atoms, typically UV to visible light.



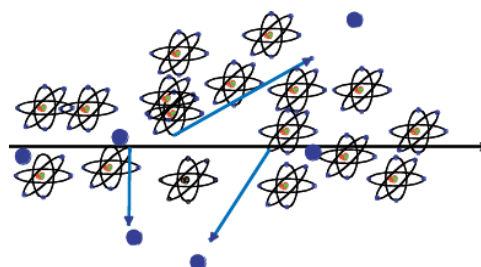

Detectors based on Registration of excited Atoms → Scintillators

Emission of photons of by excited Atoms, typically UV to visible light.

a) Observed in Noble Gases (even liquid !)

b) Inorganic Crystals

→ Substances with largest light yield. Used for precision measurement of energetic Photons. Used in Nuclear Medicine.

c) Polycyclic Hydrocarbons (Naphtalen, Anthrazen, organic Scintillators)

→ *Most important category. Large scale industrial production, mechanically and chemically quite robust. Characteristic are one or two decay times of the light emission.*



Organic ('Plastic') Scintillators

Low Light Yield

Fast: 1-3ns

Type	Light ^a output	λ_{max}^b (nm)	Attenuation ^c length (cm)	Risetime (ns)	Decay ^d time (ns)	Pulse FWHM (ns)
NE 102A	58-70	423	250	0.9	2.2-2.5	2.7-3.2
NE 104	68	406	120	0.6-0.7	1.7-2.0	2.2-2.5
NE 104B	59	406	120	1	3.0	3
NE 110	60	434	400	1.0	2.9-3.3	4.2
NE 111	40-55	375	8	0.13-0.4	1.3-1.7	1.2-1.6
NE 114	42-50	434	350-400	~1.0	4.0	5.3
Pilot B	60-68	408	125	0.7	1.6-1.9	2.4-2.7
Pilot F	64	425	300	0.9	2.1	3.0-3.3
Pilot U	58-67	391	100-140	0.5	1.4-1.5	1.2-1.9
BC 404	68	408	—	0.7	1.8	2.2
BC 408	64	425	—	0.9	2.1	~2.5
BC 420	64	391	—	0.5	1.5	1.3
ND 100	60	434	400	—	3.3	3.3
ND 120	65	423	250	—	2.4	2.7
ND 160	68	408	125	—	1.8	2.7

LHC bunchcrossing 25ns

Inorganic (Crystal) Scintillators

Large Light Yield

Slow: few 100ns

	Relative light output	λ_{max} emission (nm)	Delay time (ns)	Density (g/cm ³)
<i>Inorganic crystals</i>				
Nal(Tl)	230	415	230	3.67
CsI(Tl)	250	560	900	4.51
Bi ₄ Ge ₃ O ₁₂ (BGO)	23-86	480	300	7.13
<i>Organic crystals</i>				
Anthracene	100	448	22	1.25
Trans-stilbene	75	384	4.5	1.16
Naphthalene	32	330-348	76-96	1.03
<i>p,p'</i> -Quarterphenyl	94	437	7.5	1.20
<i>Primary activators</i>				
2,5-Diphenyl-oxazole (PPO)	75	360-416	5*	
2-Phenyl-5-(4-biphenyl)-1,3,4-oxadiazole (PBD)	96	360-5		
4,4"-Bis(2-butyloctyloxy)- <i>p</i> -quaterphenyl (BIBUQ)	60	365,393	1.30*	

LEP bunchcrossing 25 μ s

- Light guides: transfer by total internal reflection (+outer reflector)

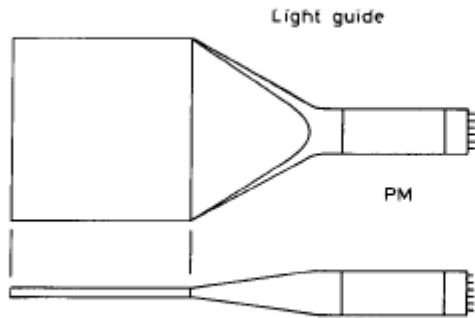

“fish tail”

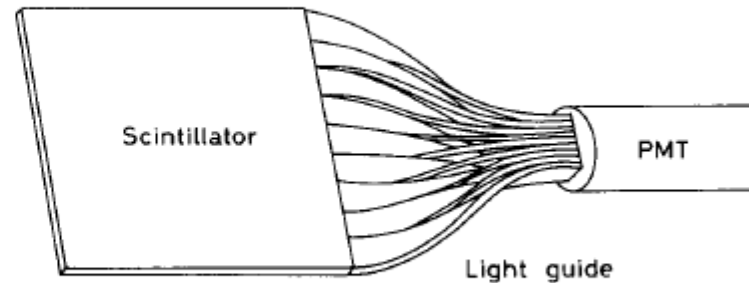

adiabatic

- wavelength shifter (WLS) bars

UV light enters the WLS material
Light is transformed into longer wavelength

→ Total internal reflection inside the WLS material

→ ‘transport’ of the light to the photo detector

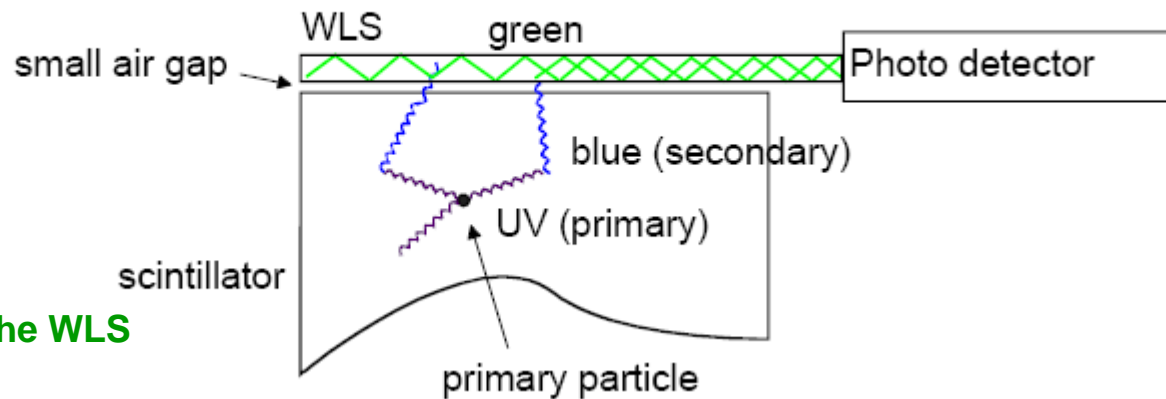

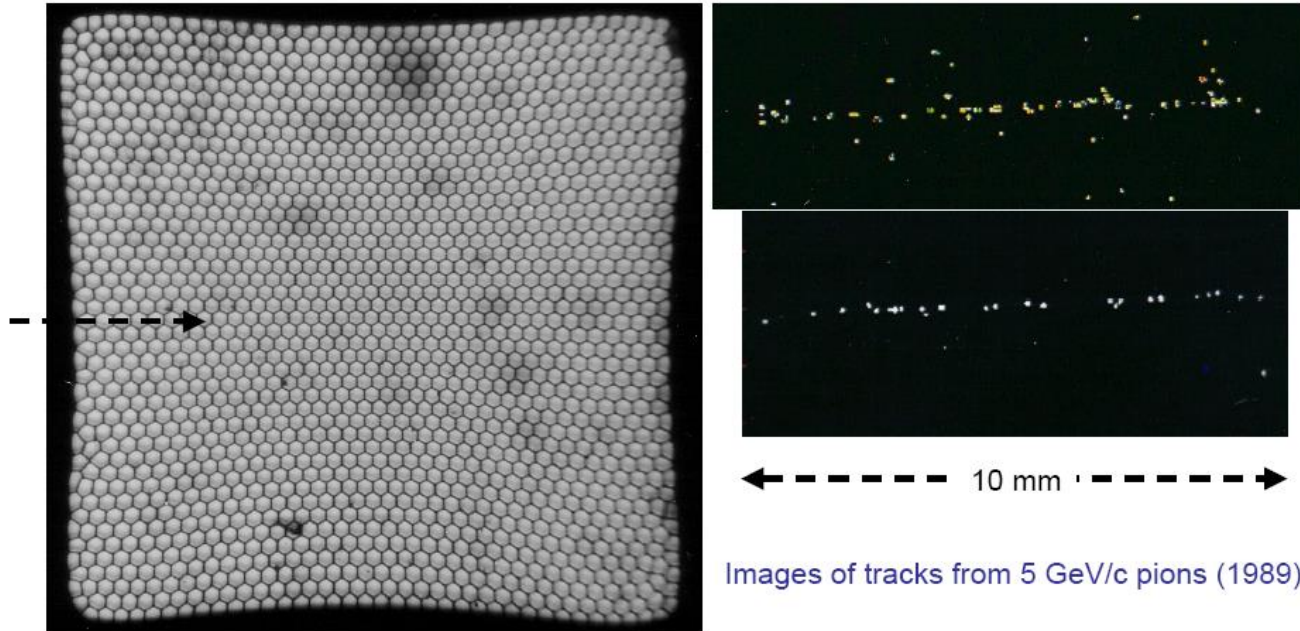

Images of tracks from 5 GeV/c pions (1989)

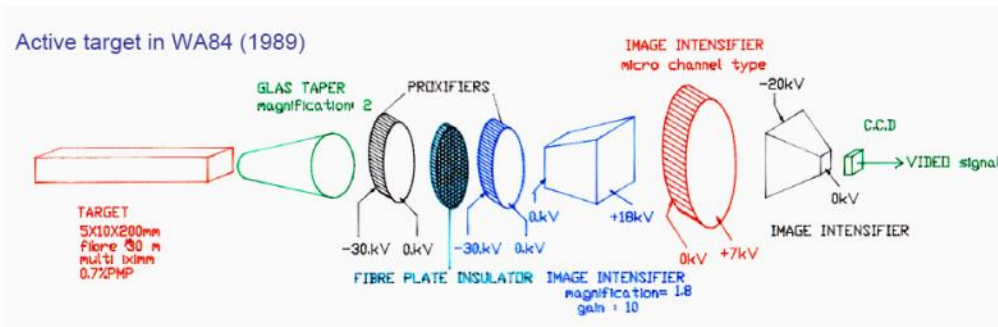

Readout of photons in a cost effective way is rather challenging.

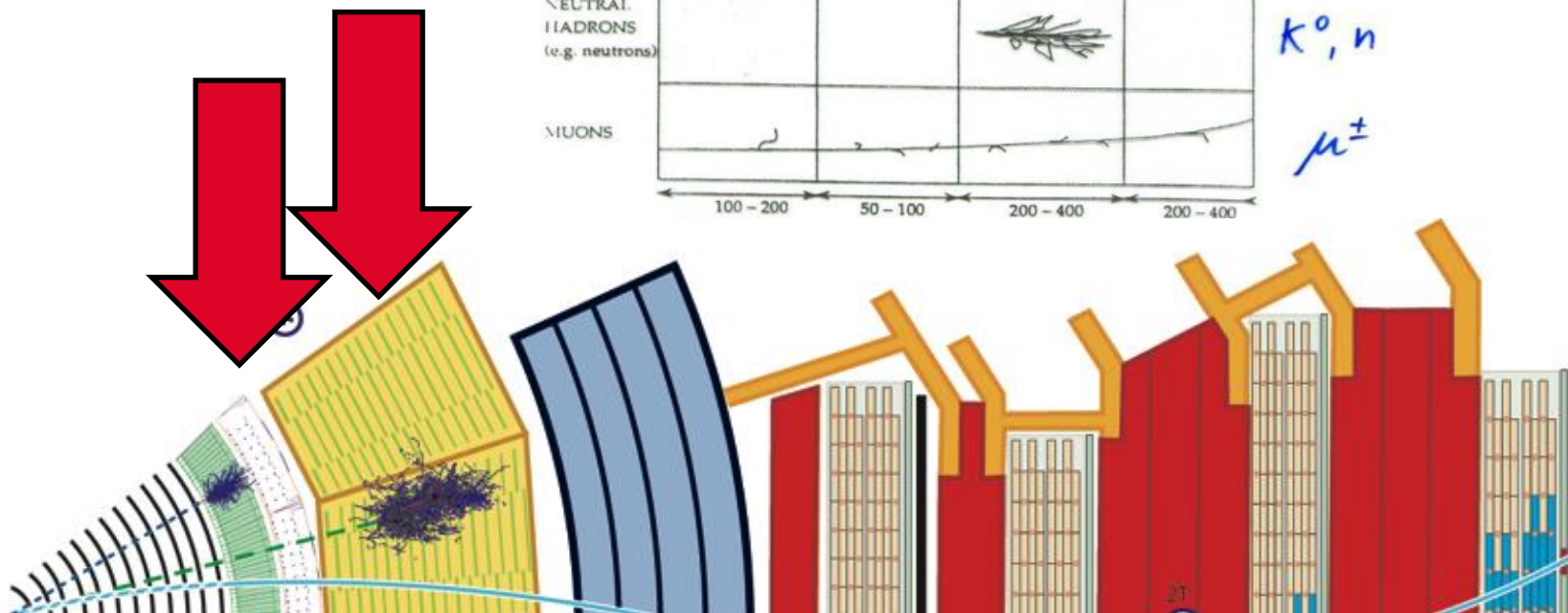
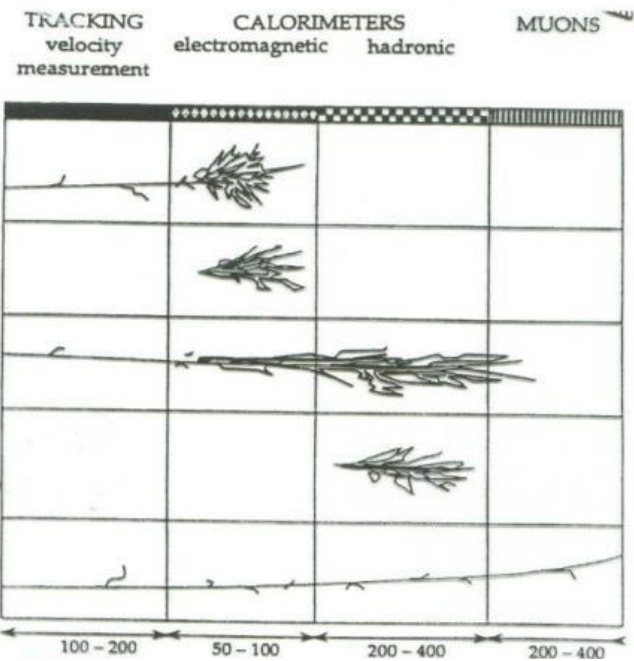

Calorimeters can be classified into:

Electromagnetic Calorimeters,

to measure electrons and photons through their EM interactions.

Hadron Calorimeters,

Used to measure hadrons through their strong and EM interactions.

The construction can be classified into:

Homogeneous Calorimeters,

that are built of only one type of material that performs both tasks, energy degradation and signal generation.

Sampling Calorimeters,

that consist of alternating layers of an absorber, a dense material used to degrade the energy of the incident particle, and an active medium that provides the detectable signal.

C.W. Fabjan and F. Gianotti, Rev. Mod. Phys., Vol. 75, N0. 4, October 2003

At high energies (higher than 100 MeV) electrons lose their energy almost exclusively by bremsstrahlung while photons lose their energy by electron-positron pair production

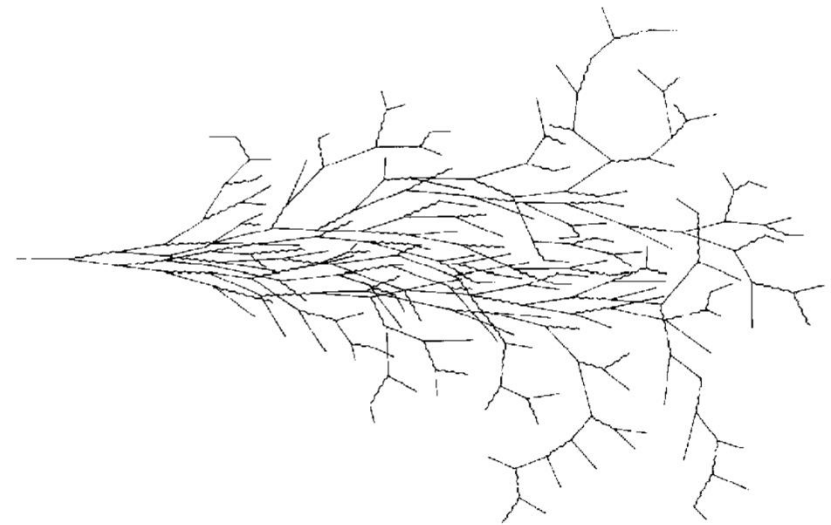
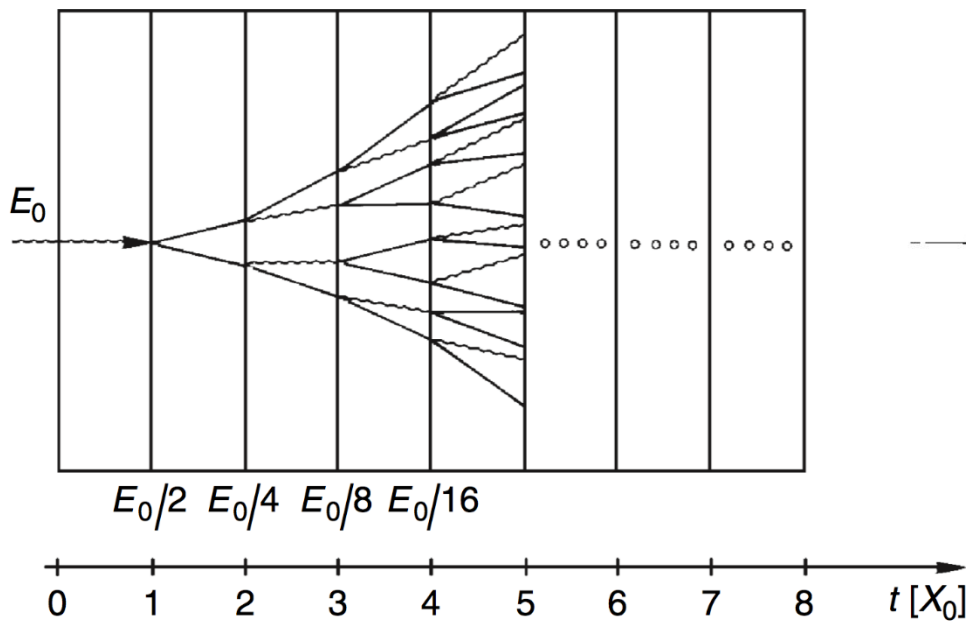

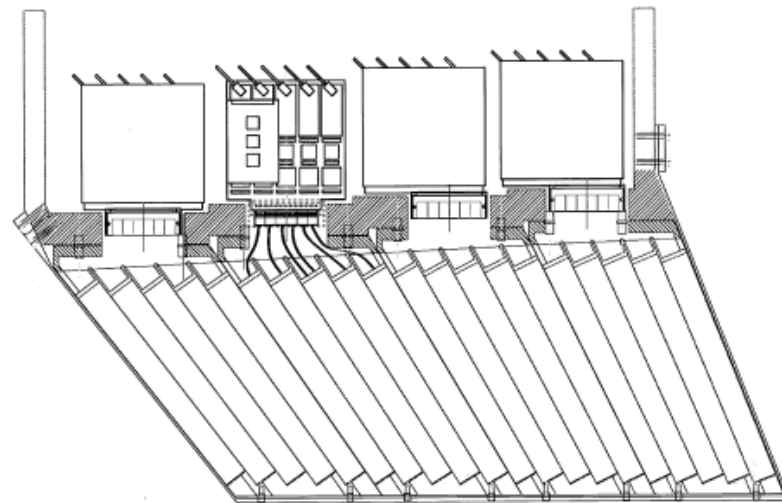
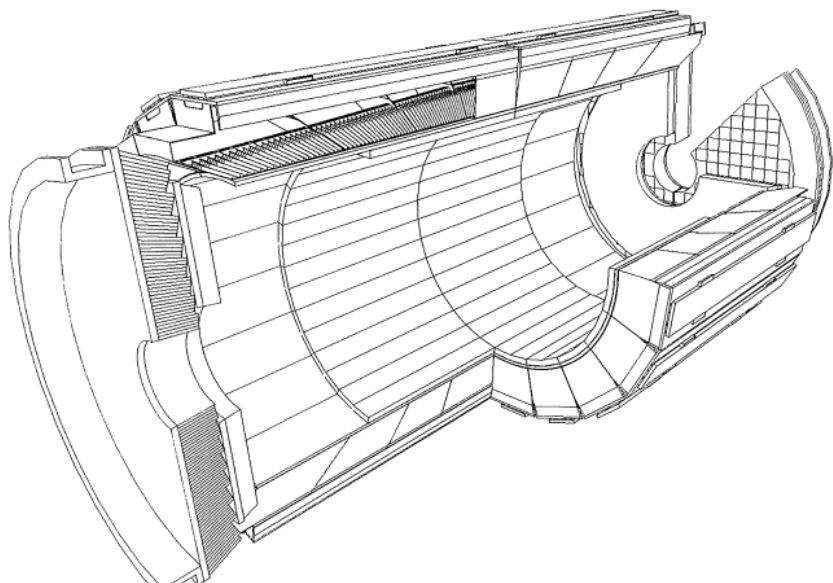
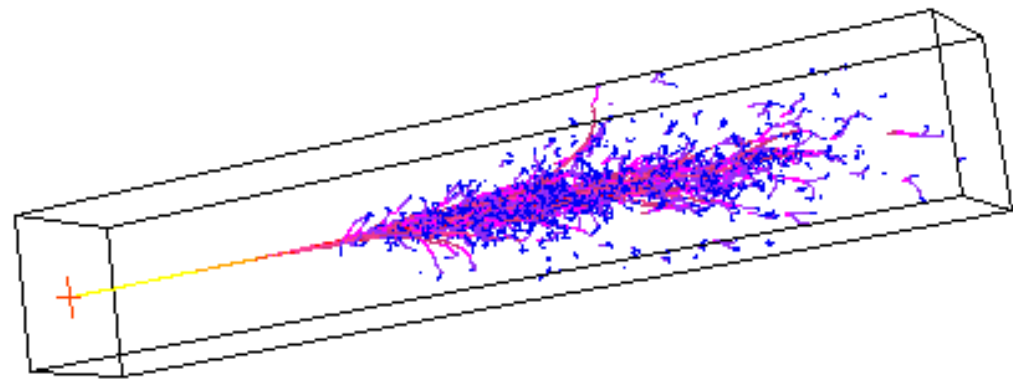
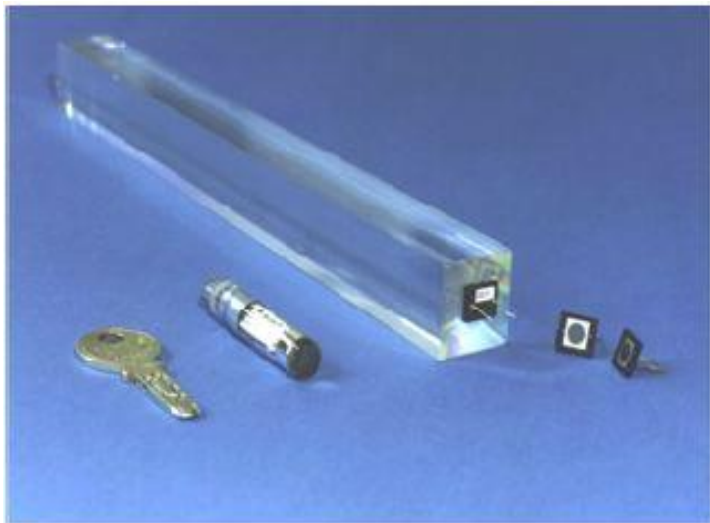

Fig. 2. Longitudinal drawing of module 2, showing the structure and the front-end electronics layout.

Hadron Calorimeters are Large because λ is large

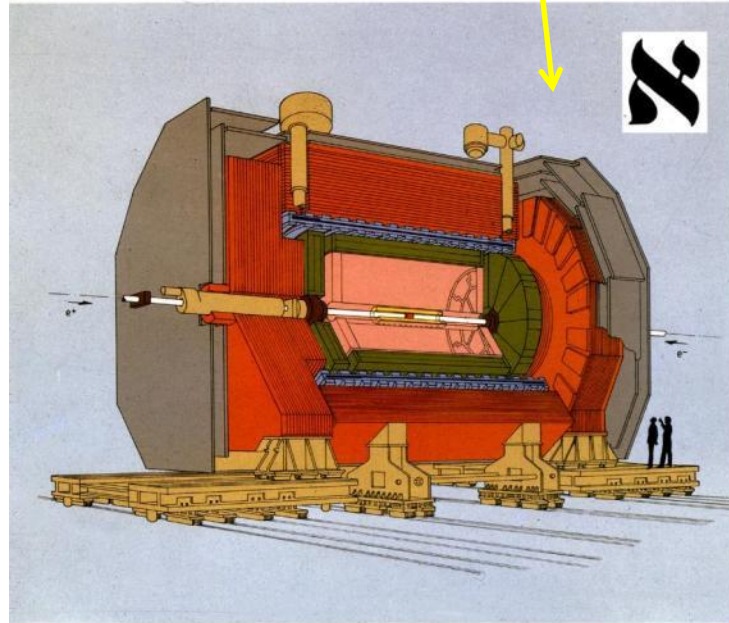
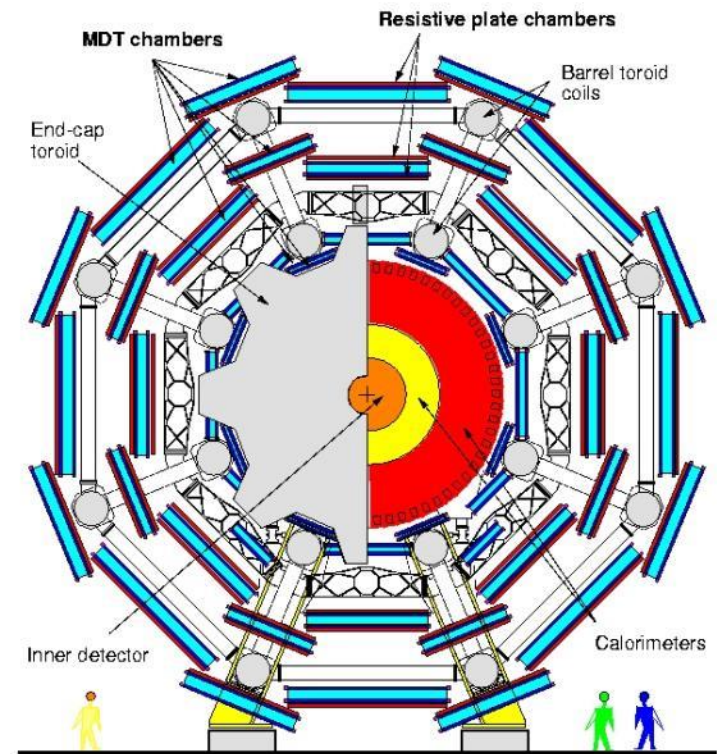
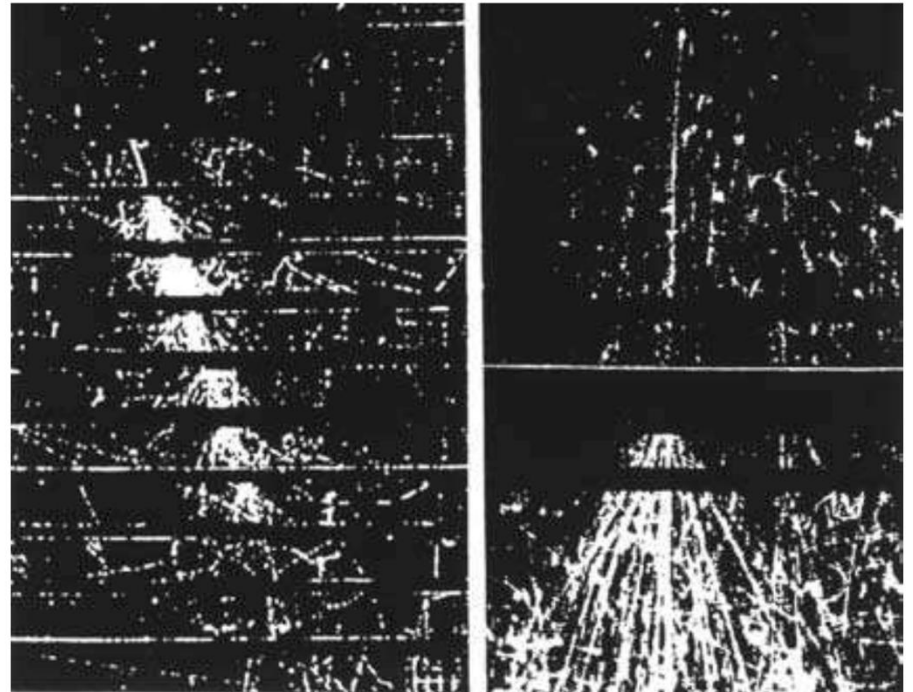
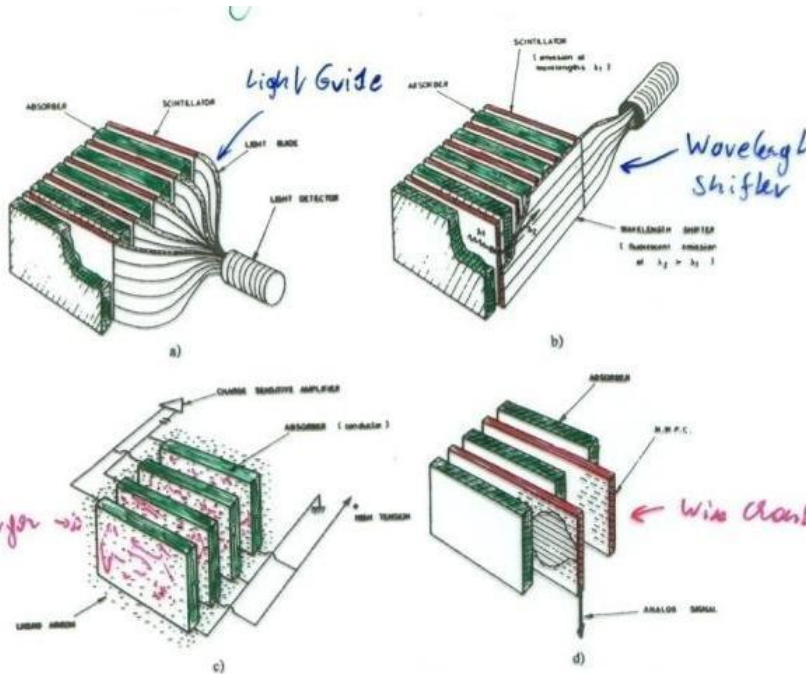

Fig. 1 - The ALEPH Detector

- Vertex Detector
- Inner Track Chamber
- Time Projection Chamber
- Electromagnetic Calorimeter
- Superconducting Magnet Coil
- Hadron Calorimeter
- Muon Detection Chambers
- Luminosity Monitors

Hadron Calorimeters are large and heavy because the hadronic interaction length λ , the 'strong interaction equivalent' to the EM radiation length X_0 , is large (5-10 times larger than X_0)





La détection des particules: exemple des détecteurs gazeux

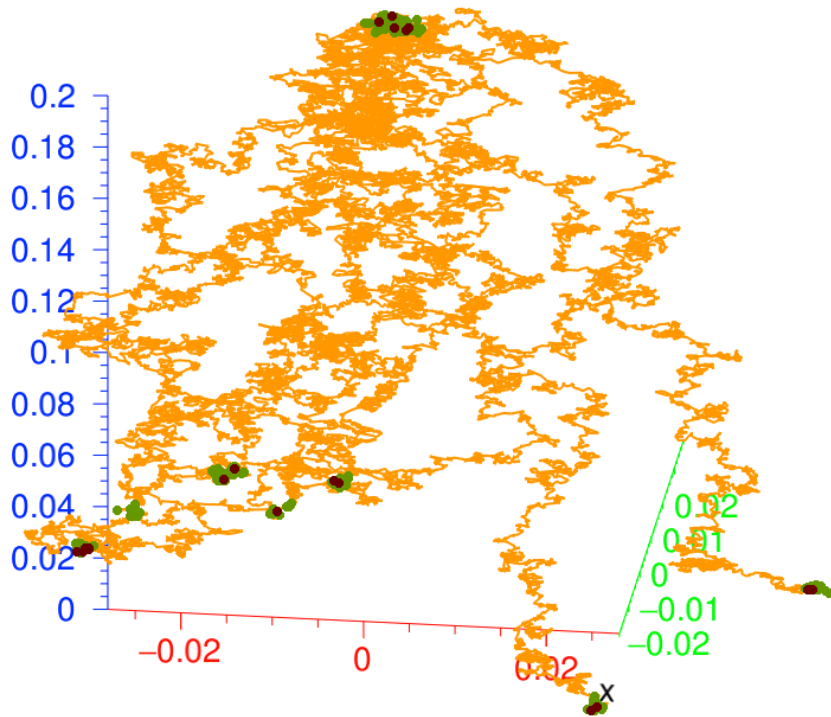

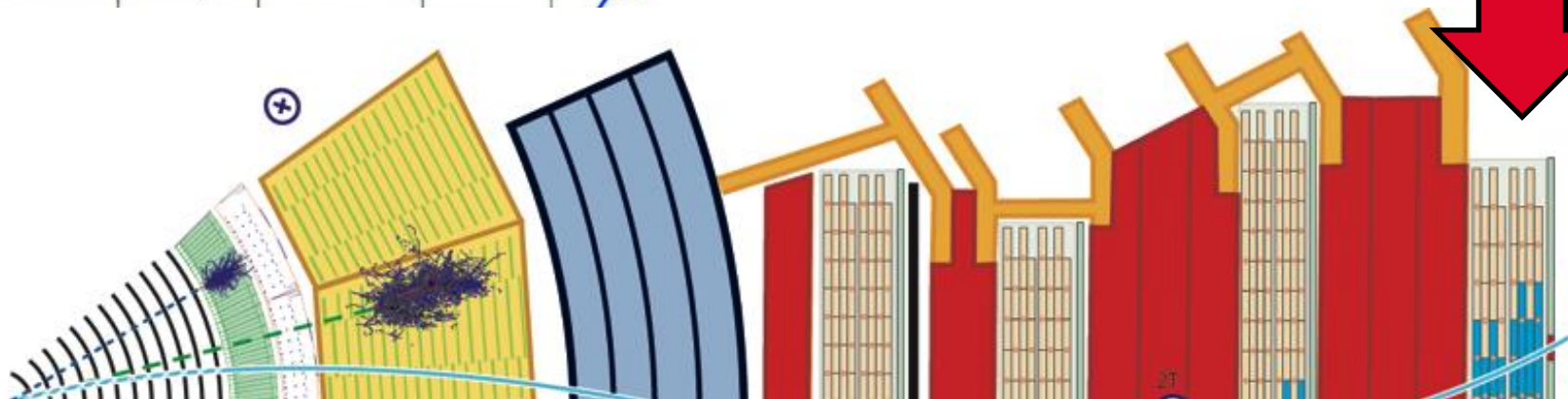
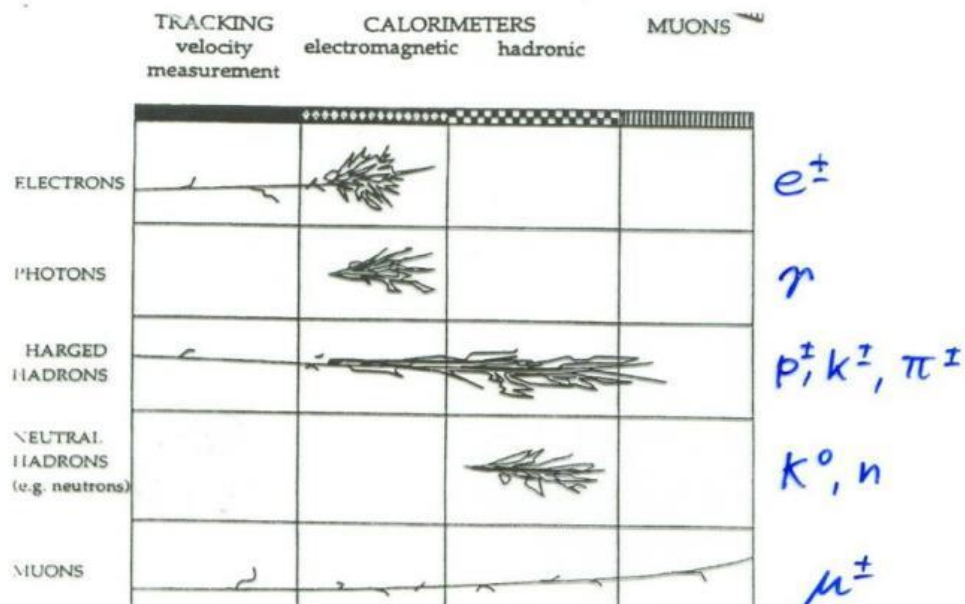

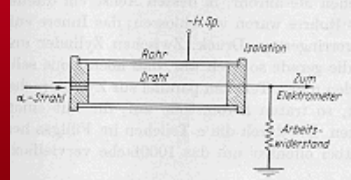

(RADIAL) AVEC:
$$E = \frac{1}{r} \frac{V_0}{\ln(b/a)}$$

- R : DISTANCE RADIALE À L'AXE
- B : RAYON INTERNE DU CYLINDRE
- A : RAYON DU FIL D'ANODE

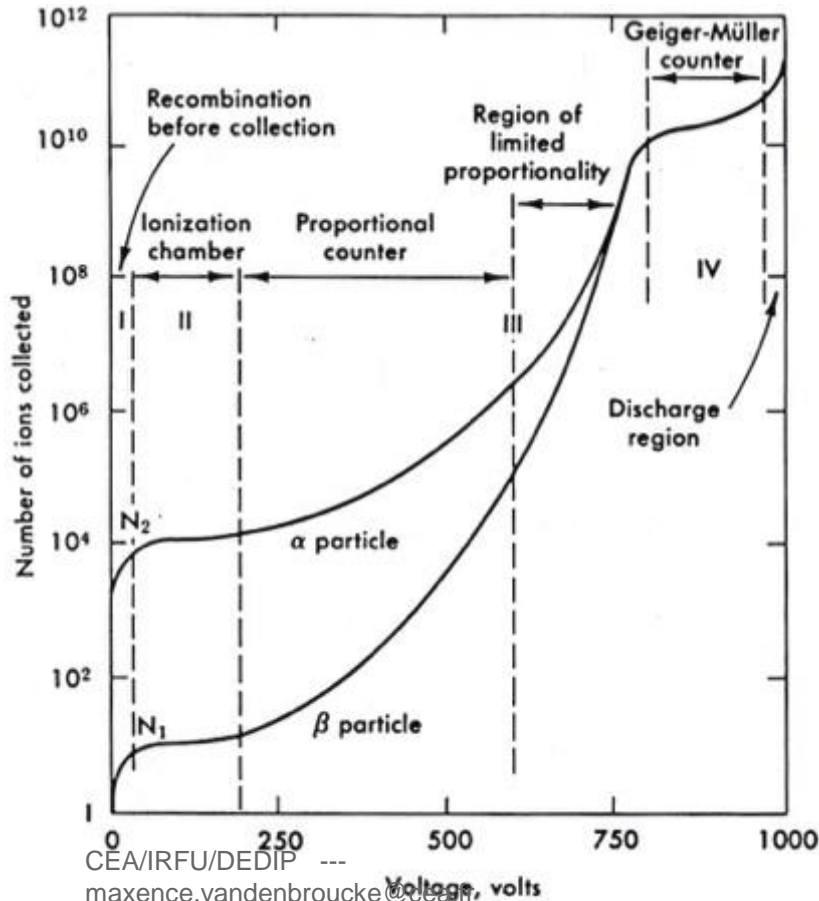
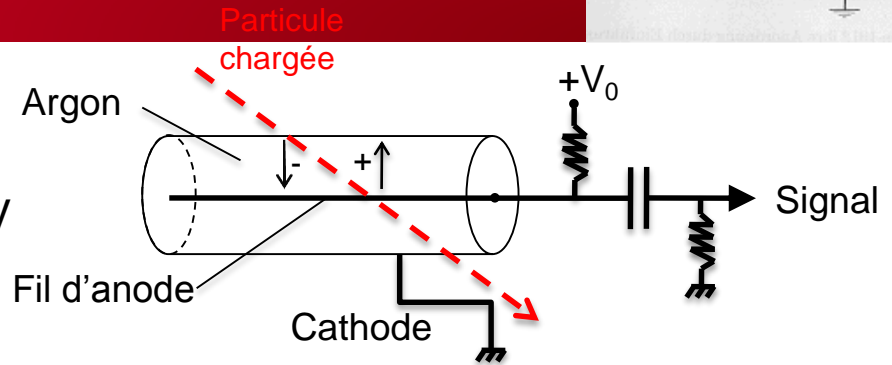
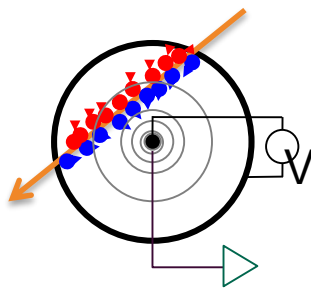

I: tension trop faible → recombinaison

II: Chambre d'ionisation. Collection des charges sans amplification.

IIIa: Mode **proportionnel**. Le signal est amplifié et proportionnel à l'énergie déposée.

IIIb: Mode **Streamer**. Phénomènes secondaires induits par les photons de la première avalanche → Gaz quencher

IV: Mode **Geiger-Müller**. Avalanche dans tout le détecteur. Le courant de sortie est saturé.

Production de paires électron-ion :

- Les interactions Coulombiennes entre le champ électrique de la particule et les atomes du milieu produisent des paires électron-ion.
- Les ionisations multiples suivent une statistique de Poisson:

$$P_k^n = \frac{n^k}{k!} e^{-n} \quad \begin{array}{l} n : \text{moyen} \\ k : \text{mesuré} \end{array}$$

- Efficacité de détection: $e = 1 - P_0^n = 1 - e^{-n}$

– Mécanismes d'ionisation :

- Excitation: $X + p \rightarrow X^* + p$ puis $X^* \rightarrow X^+ + e^-$
- Ionisation: $X + p \rightarrow X^+ + p + e^-$
- *Effet Penning*: $Ne^* + Ar \rightarrow Ne + Ar^+ + e^-$

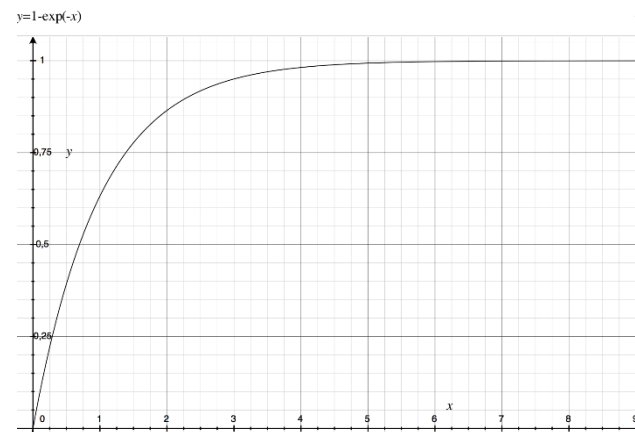
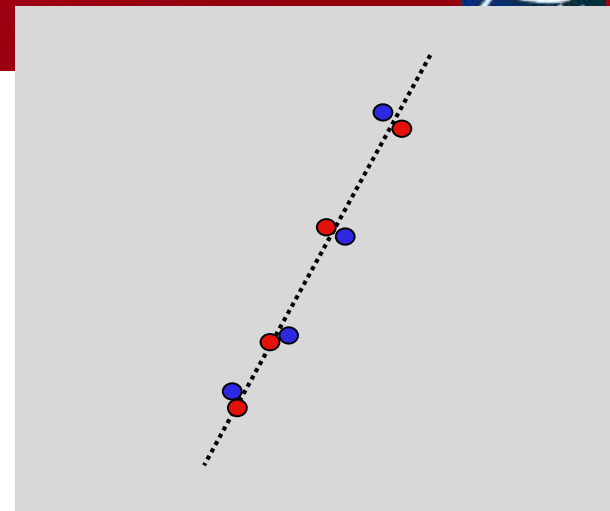



- Les électrons primaires ionisent à nouveau le milieu et produisent localement de nouveaux groupes de paires électron-ion. Si l'électron secondaire a suffisamment d'énergie il peut produire une longue trace (électron δ).
- Nombre total de paires:

$$n_T = \frac{\Delta E}{w_i}$$

ΔE : perte d'énergie de la particule
 w_i : énergie moyenne par paire

M.I.P. dans l'argon:

- $\Delta E = 2,65 \text{ keV/cm}$ $w_i = 25 \text{ eV}$
- $n_T \approx 106 \text{ paires électron-ion/cm}$

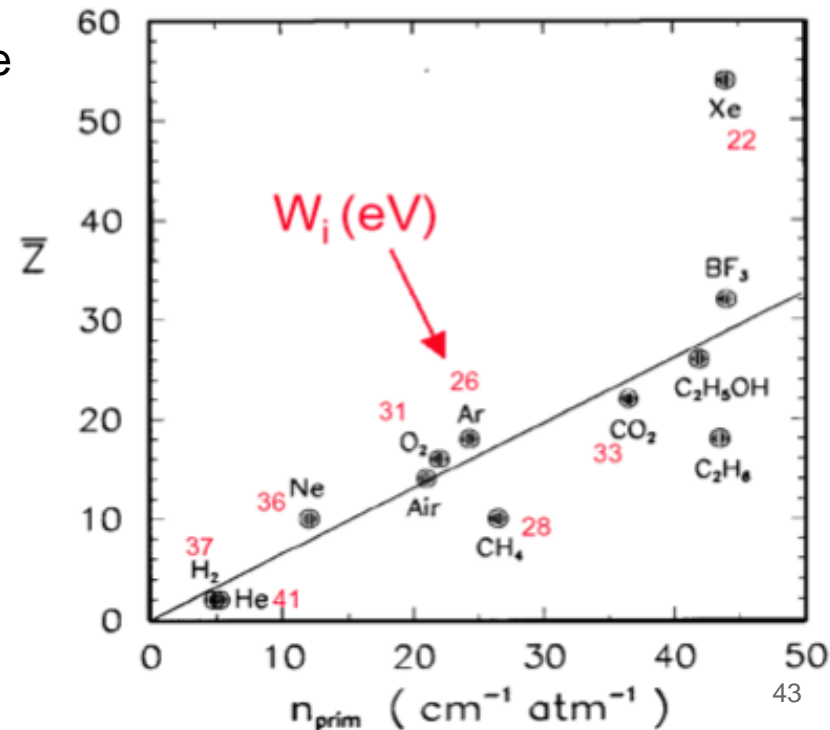
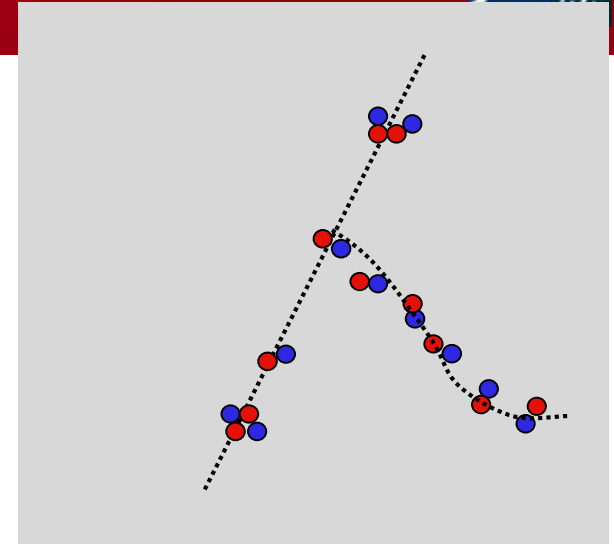

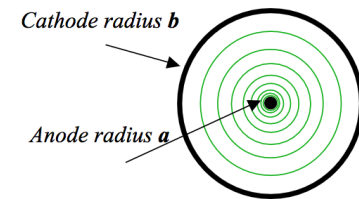
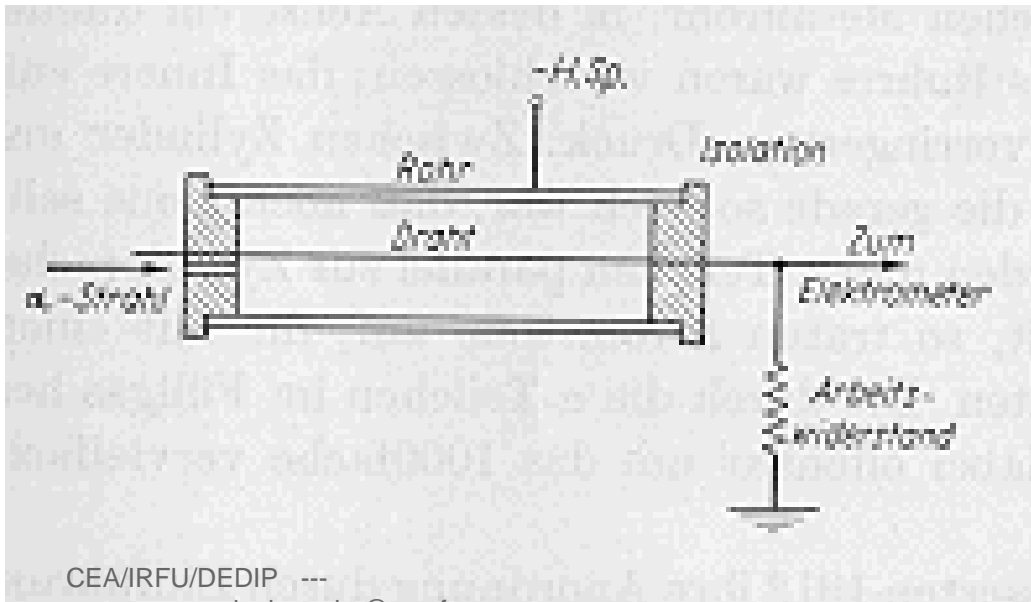
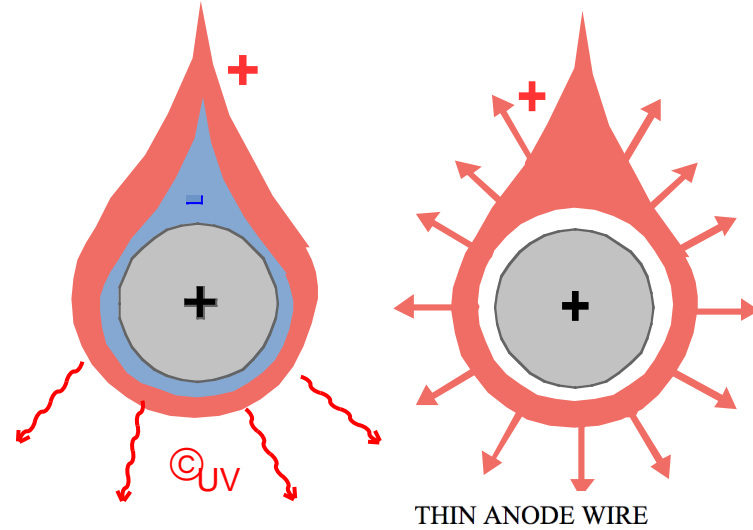
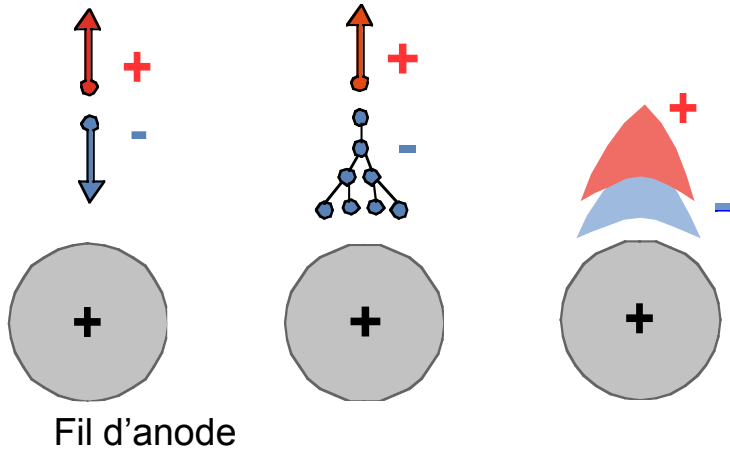

ELECTRIC FIELD AND POTENTIAL:

$$E(r) = \frac{CV_0}{2\pi\epsilon_0} \frac{1}{r}$$

$$V(r) = \frac{CV_0}{2\pi\epsilon_0} \ln \frac{r}{a}$$

$$C = \frac{2\pi\epsilon_0}{\ln(b/a)} \quad \text{capacitance per unit length}$$

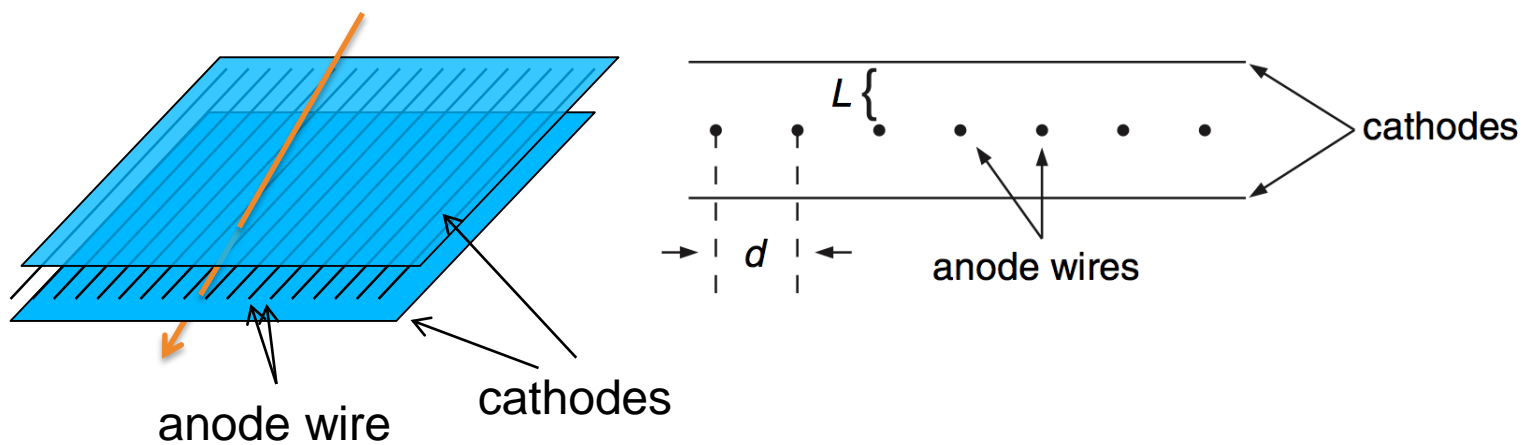

EN COMPARAISON DES CHAMBRES À ÉTINCELLES ET DES CHAMBRES À BULLES, LES CHAMBRES À FILS SONT PLUS RAPIDES, PRÉSENTENT DE MEILLEURES RÉOLUTIONS SPATIALE ET TEMPORELLE, SANS TEMPS MORT SIGNIFICATIF ET RÉSISTANTES AUX RADIATIONS.



The Royal Swedish Academy of Sciences awards the 1992 Nobel Prize in Physics to **Georges Charpak** for his invention and development of particle detectors, in particular the multiwire proportional chamber.

Georges Charpak
CERN, Geneva, Switzerland

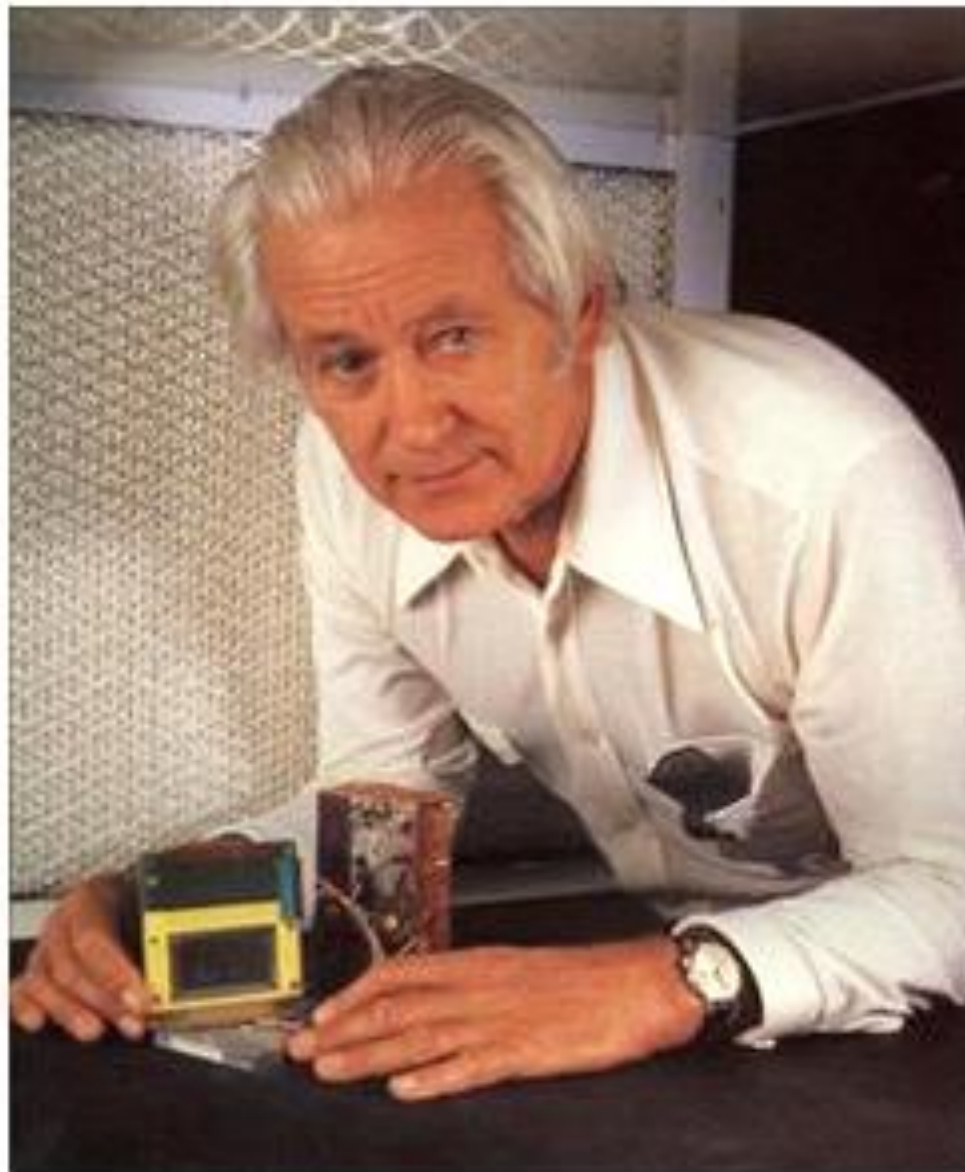
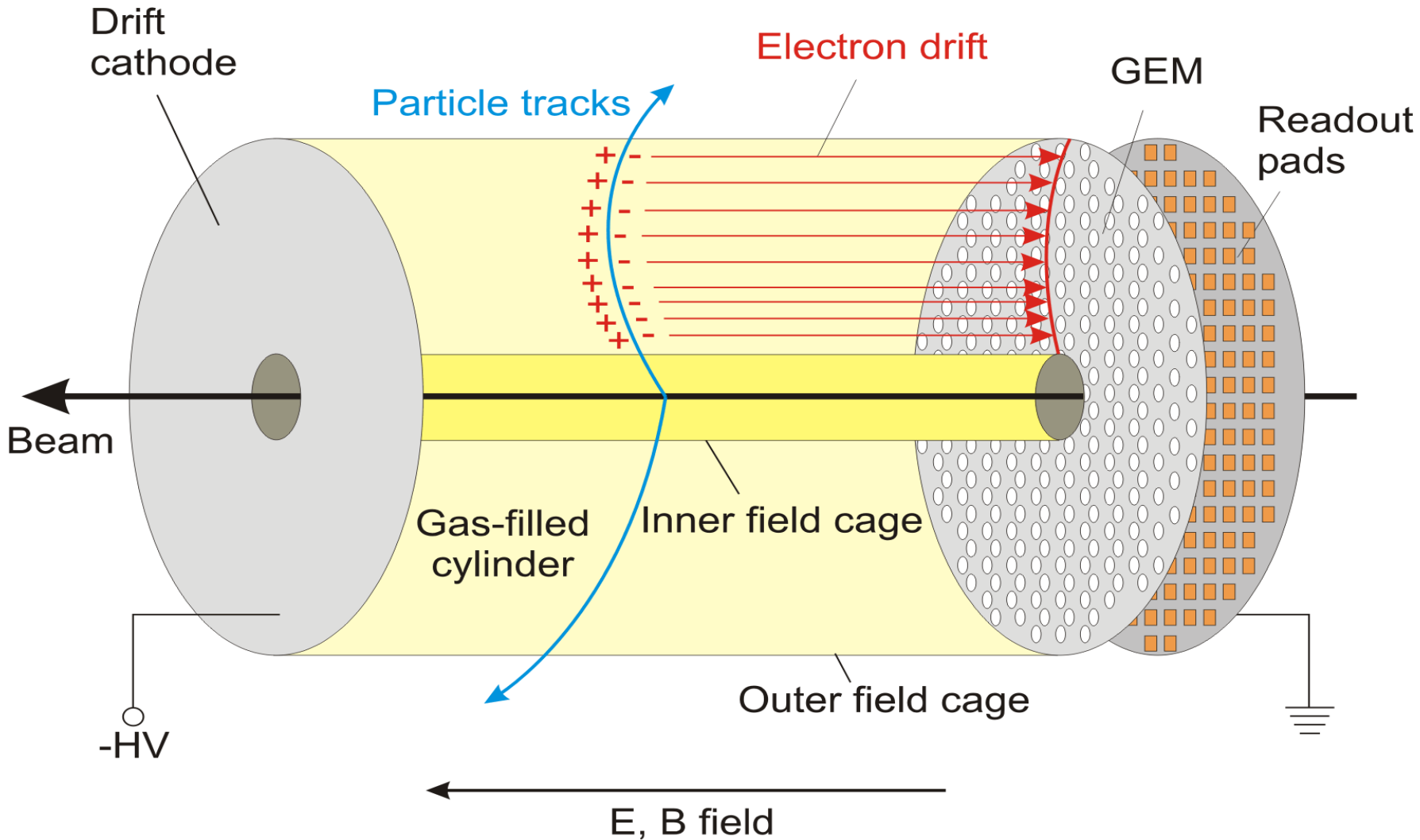
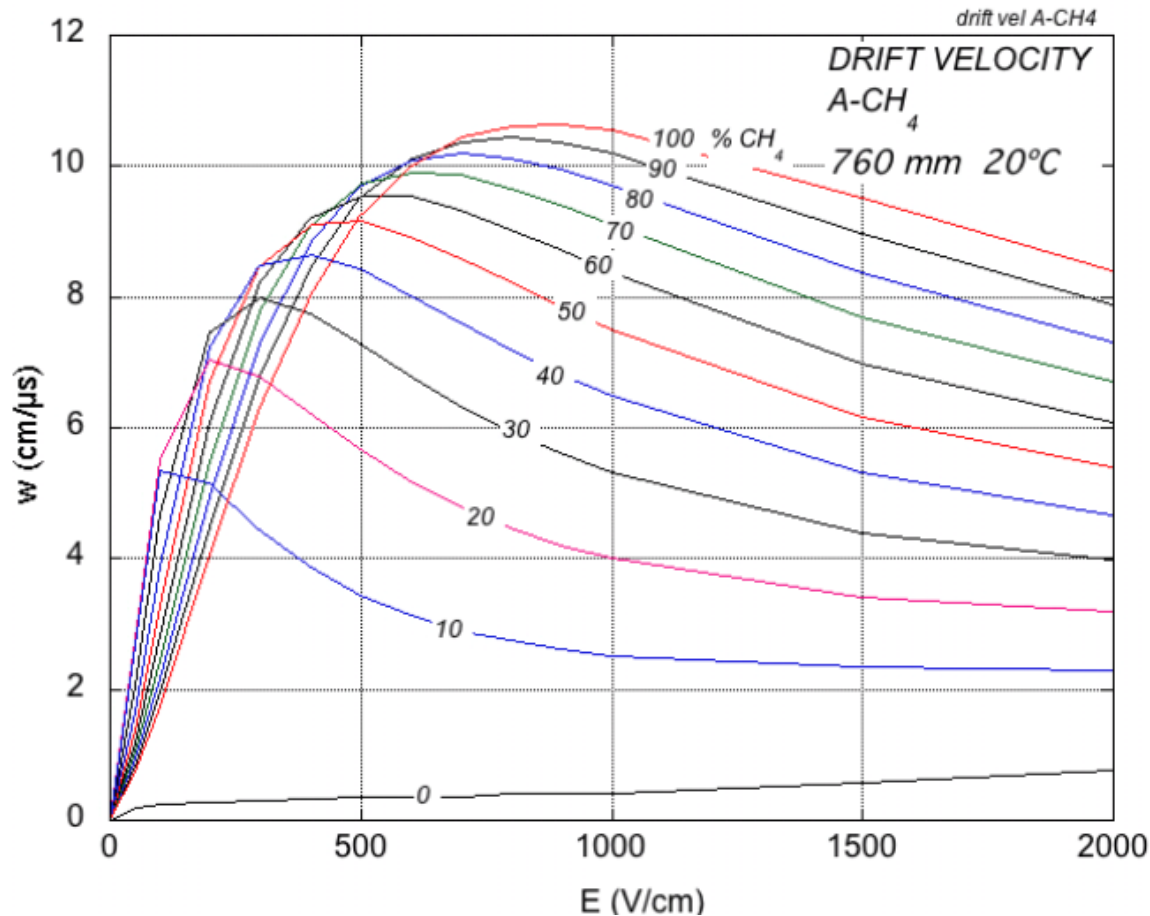

Photo: D. Parker, Science Photo Lab, UK



- 1927:** C.T.R. Wilson, Cloud Chamber
- 1939:** E. O. Lawrence, Cyclotron & Discoveries
- 1948:** P.M.S. Blacket, Cloud Chamber & Discoveries
- 1950:** C. Powell, Photographic Method & Discoveries
- 1954:** Walter Bothe, Coincidence method & Discoveries
- 1960:** Donald Glaser, Bubble Chamber
- 1968:** L. Alvarez, Hydrogen Bubble Chamber & Discoveries
- 1992:** Georges Charpak, Multi Wire Proportional Chamber





EXAMPLE: Ar-CH₄ 90-10 , E=1kVcm⁻¹ w = 2.5 cm μ s⁻¹

Event display of a Au Au collision at CM energy of 130 GeV/n.

Typically around 200 tracks per event.

Great advantage of a TPC: The only material that is in the way of the particles is gas → very low multiple scattering → very good momentum resolution down to low momenta !

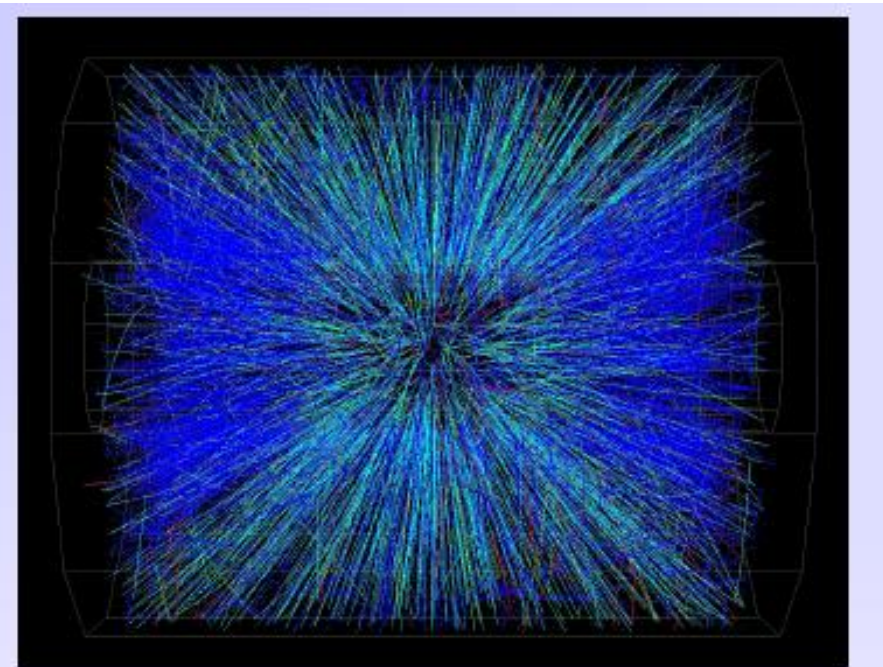
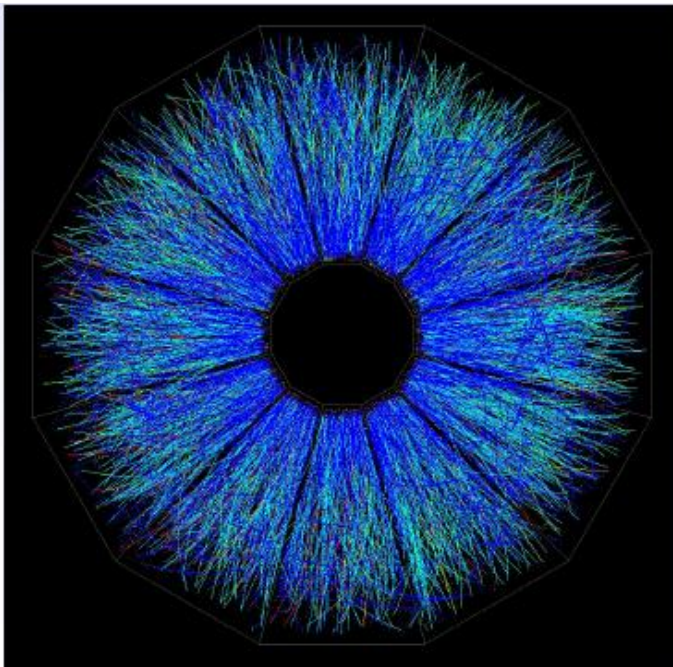

- Gas Ne/ CO₂ 90/10%
- Field 400V/cm
- Gas gain >10⁴
- Position resolution $\sigma = 0.25\text{mm}$
- Diffusion: $\sigma_t = 250\mu\text{m}$
- Pads inside: 4x7.5mm
- Pads outside: 6x15mm
- B-field: 0.5T
- Largest TPC:
 - Length 5m
 - Diameter 5m
 - Volume 88m³
 - Detector area 32m²
 - Channels ~570 000
- High Voltage:
 - Cathode -100kV

$\sqrt{\text{cm}}$

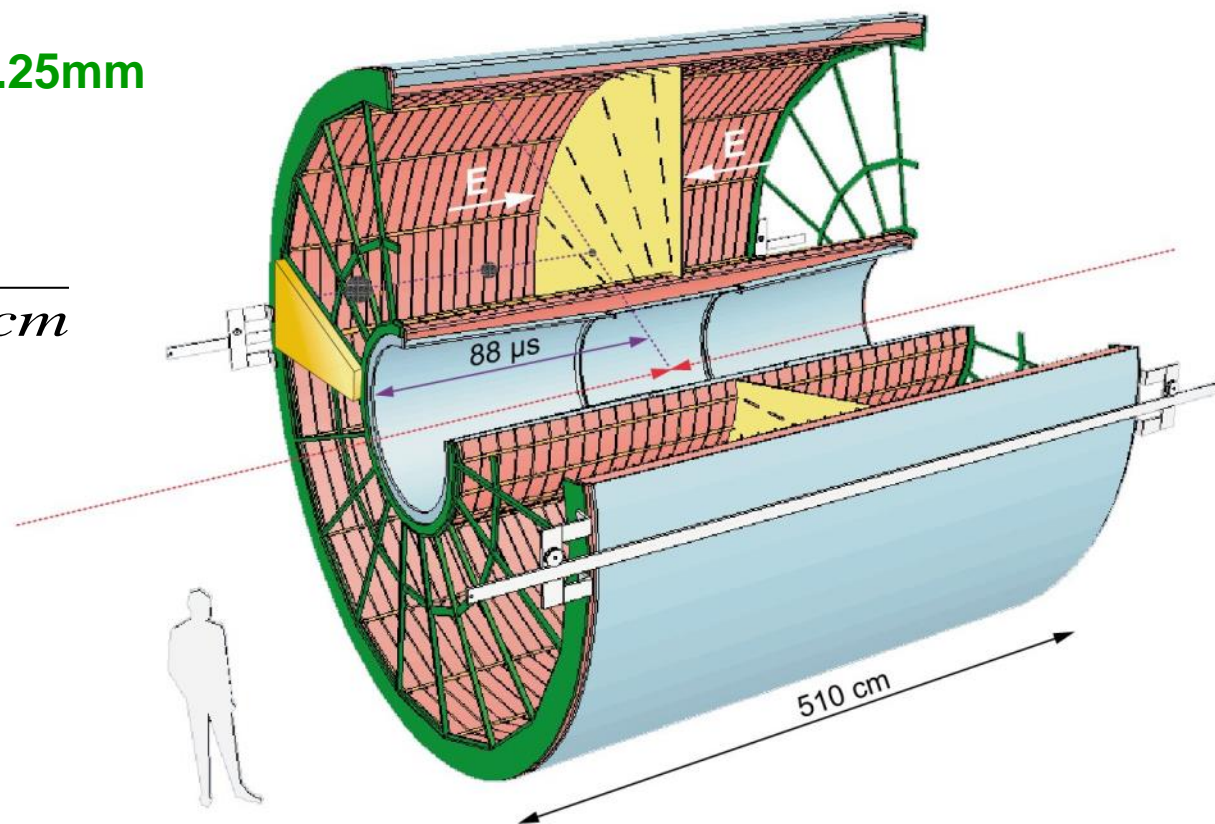

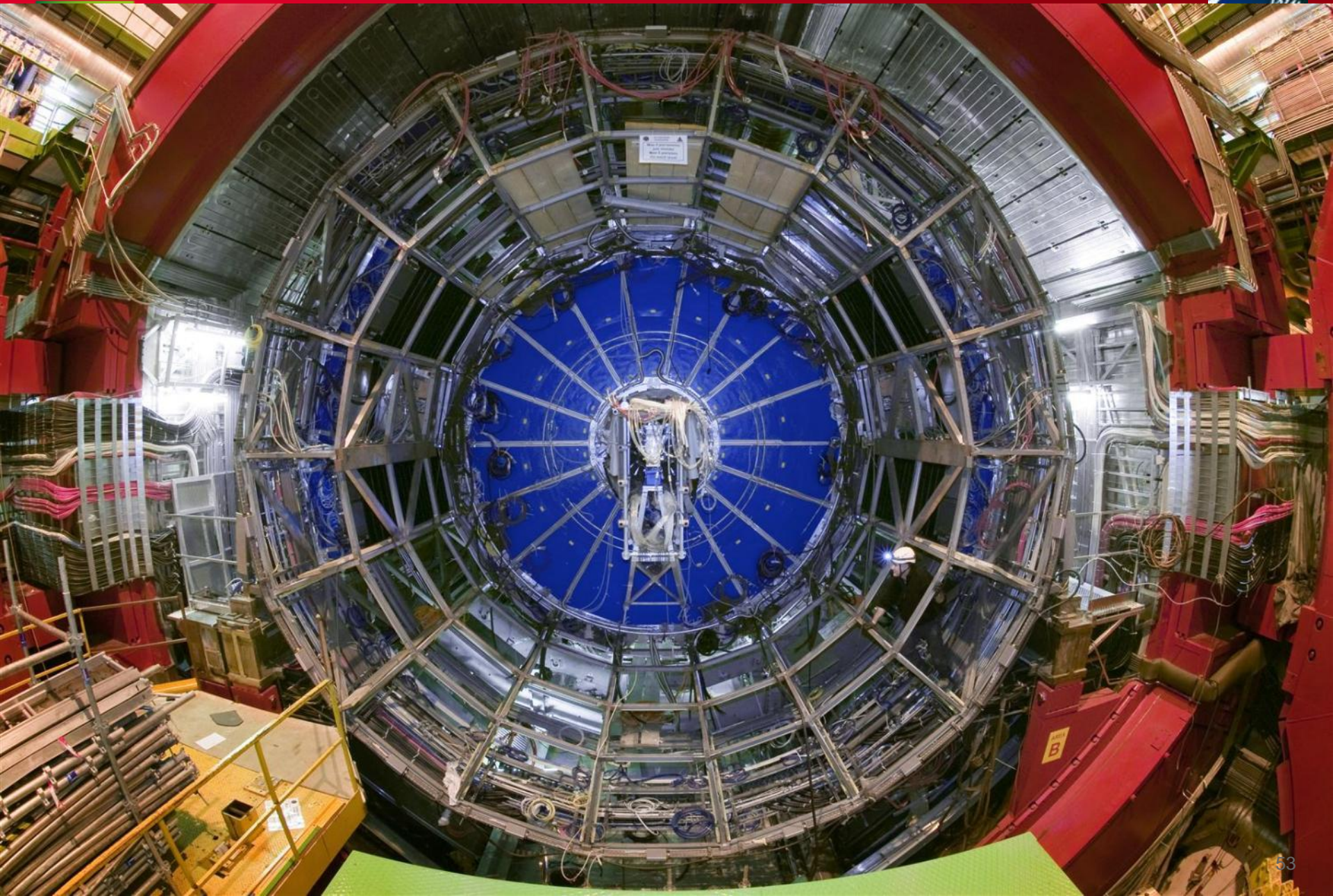

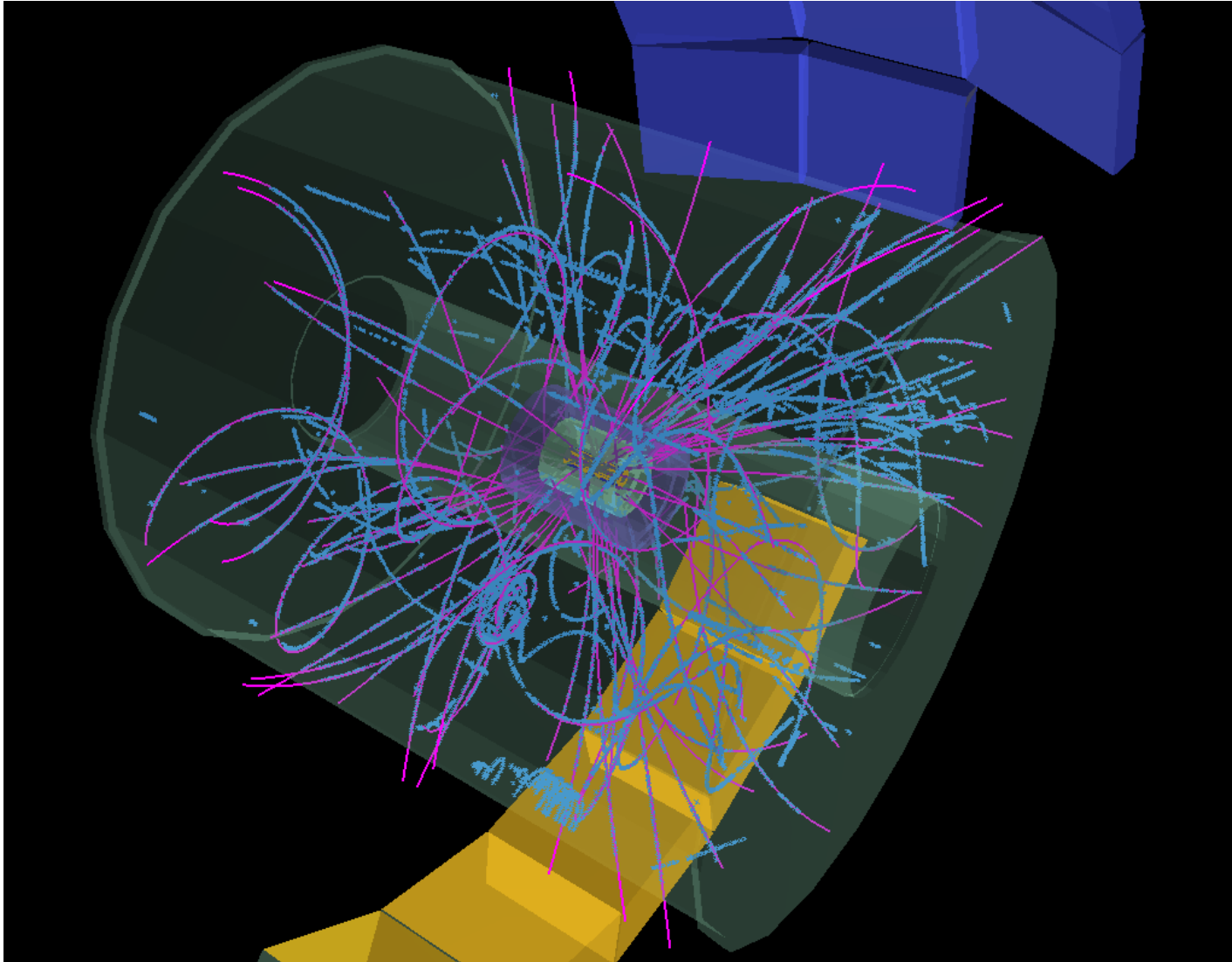

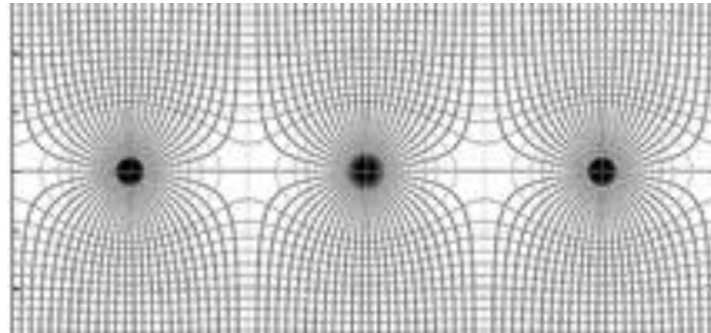

DRIFT CHAMBERS (1980):

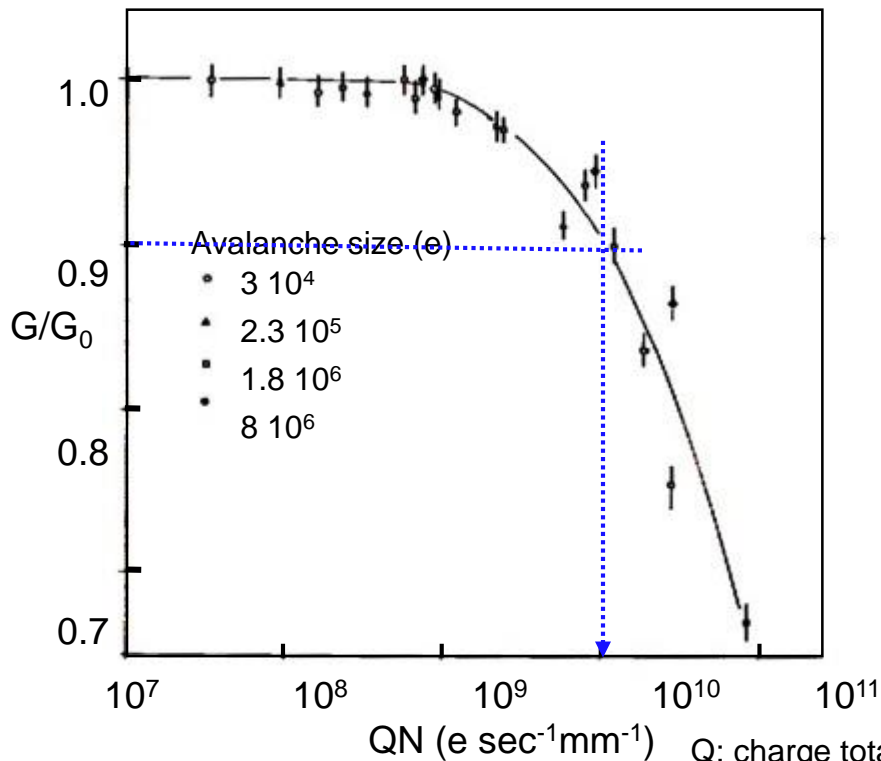

ATLAS MONITORED DRIFT TUBES (2000):

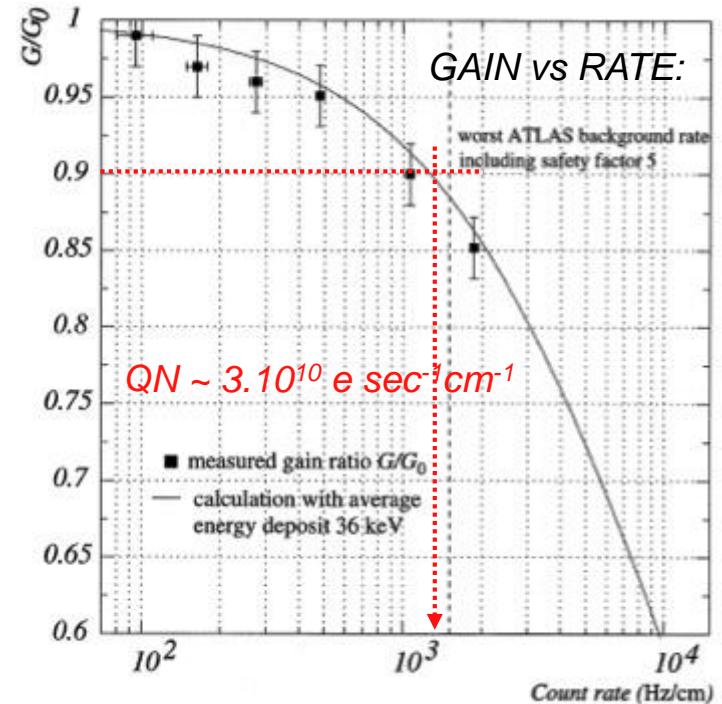

Électrode de dérivation MICRO-PIN ARRAY (MIPA)

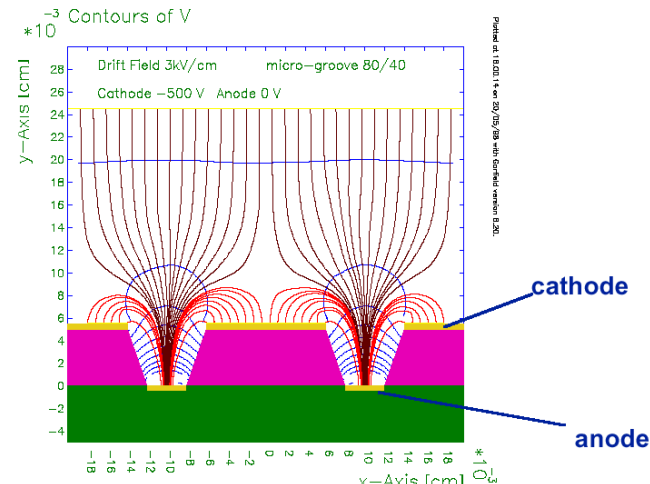
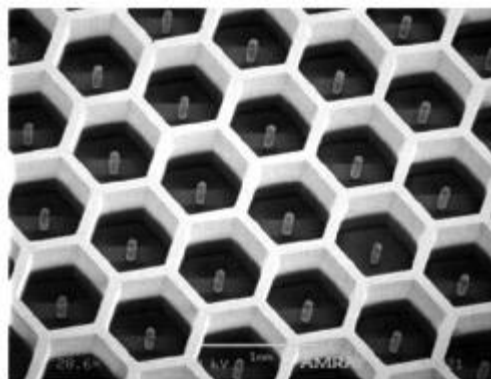
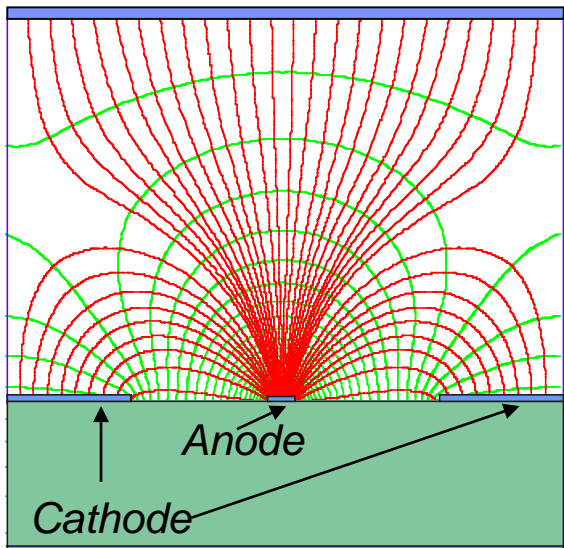

MICRO-PIXEL CHAMBER

Equipotential and drift lines (with zero diffusion)

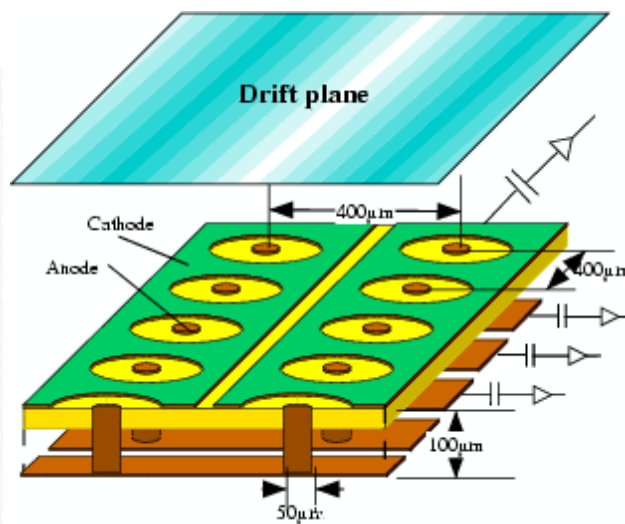
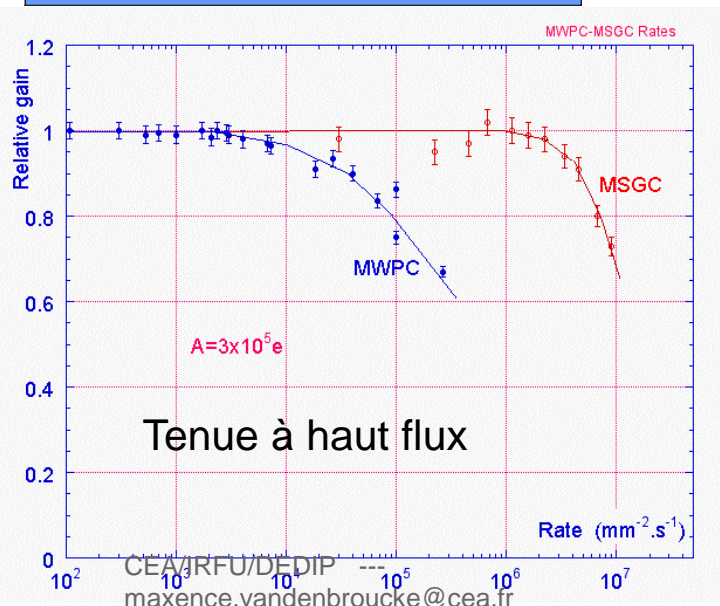

MICRO-GAP CHAMBER

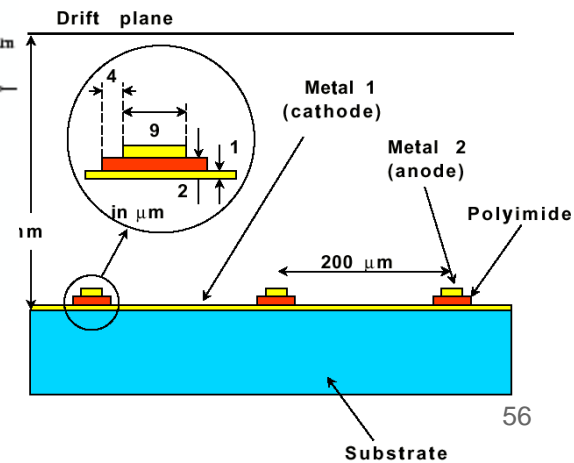

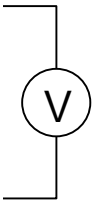
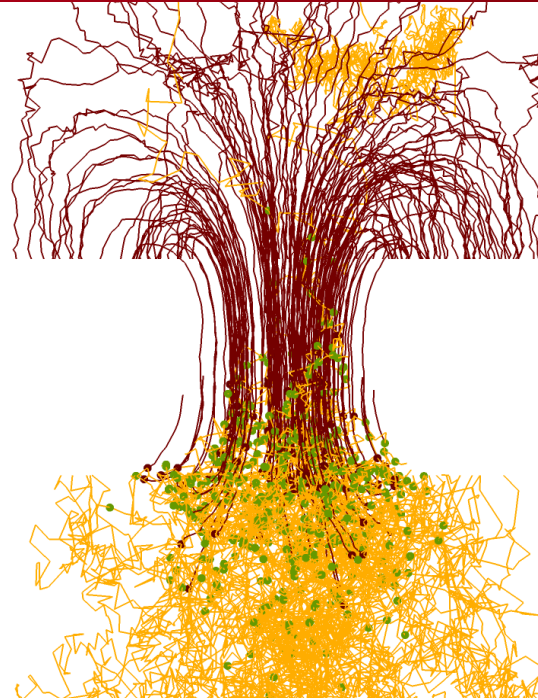
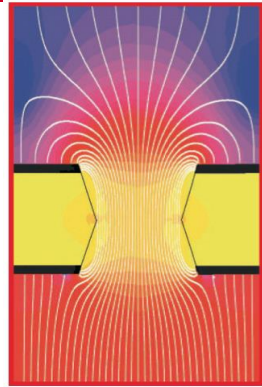
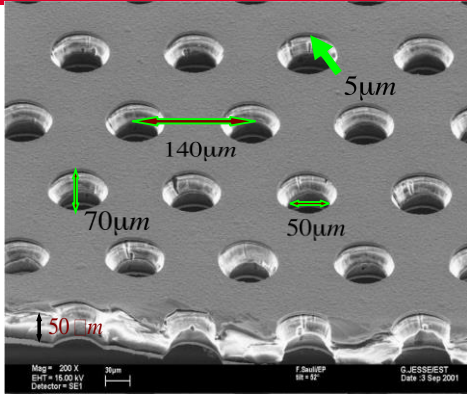

$\Delta V \sim 360V$

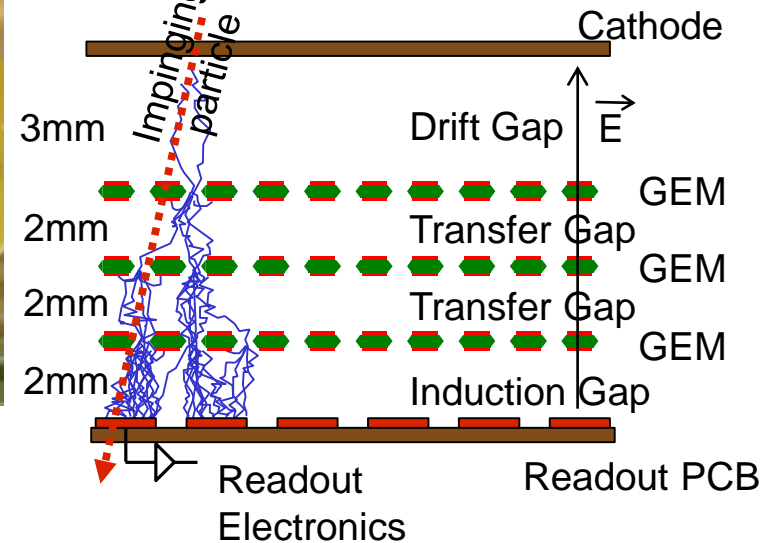
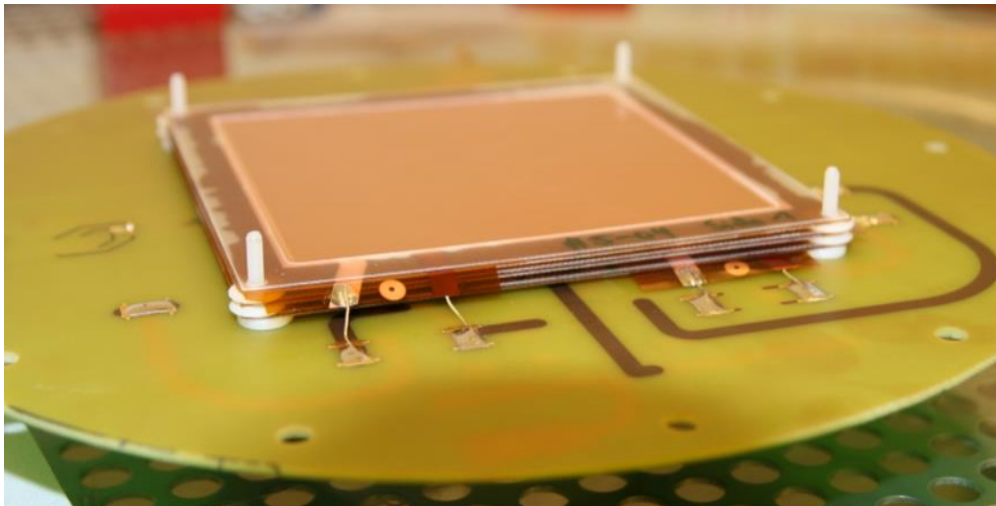

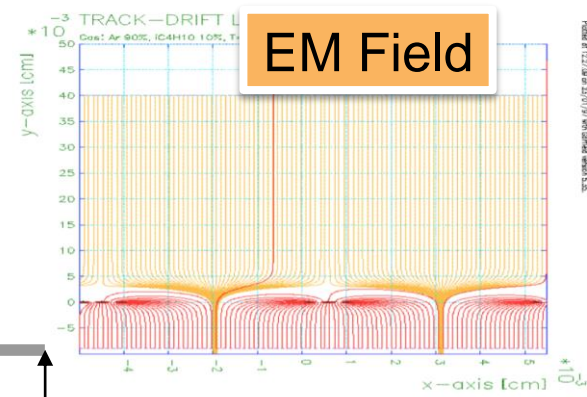
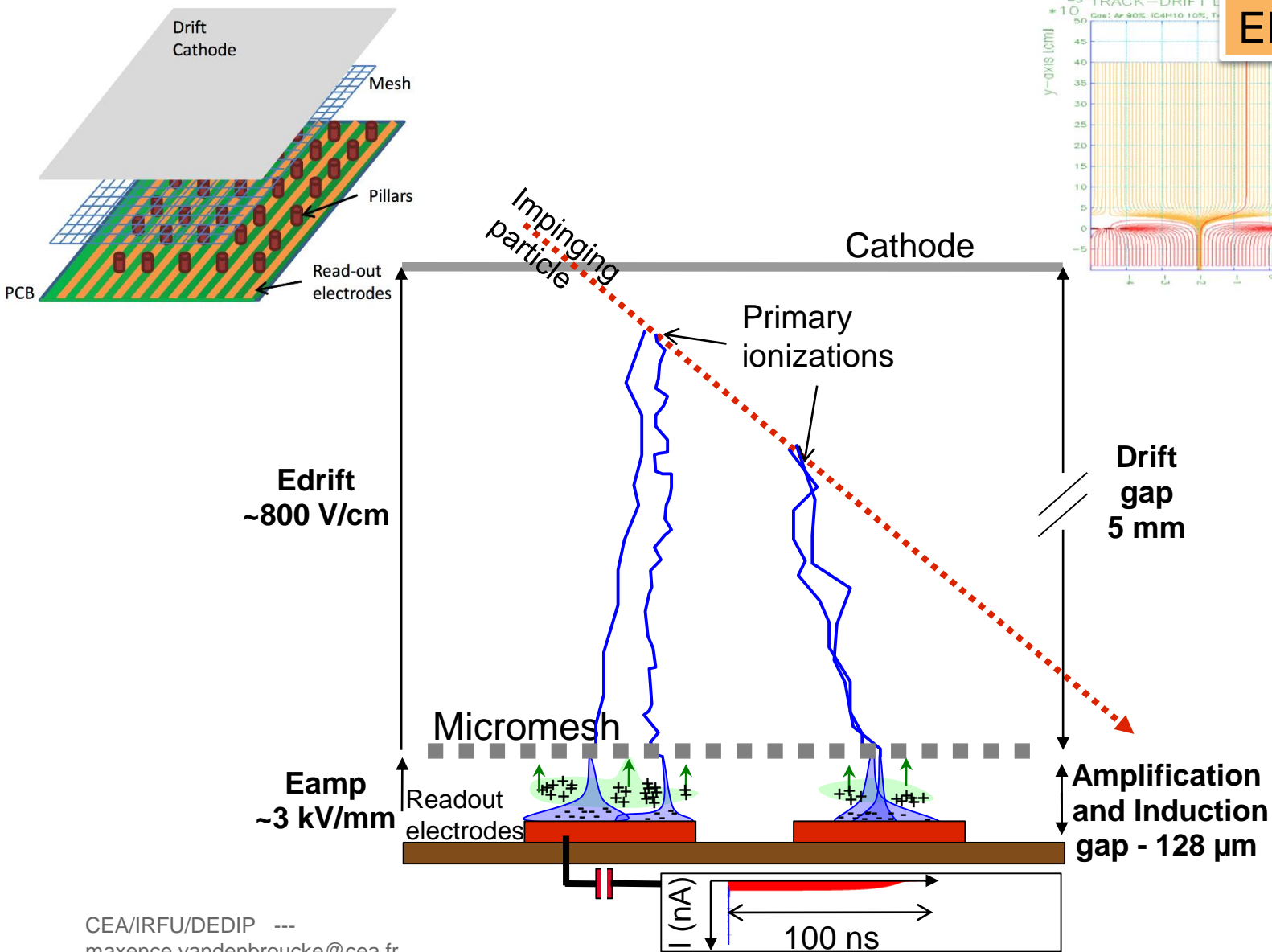

APPLICATIONS EN PHYSIQUE...



Grands détecteurs pour le système à muons d'ATLAS/HL-LHC



TPC pour l'ILC



CLAS 12

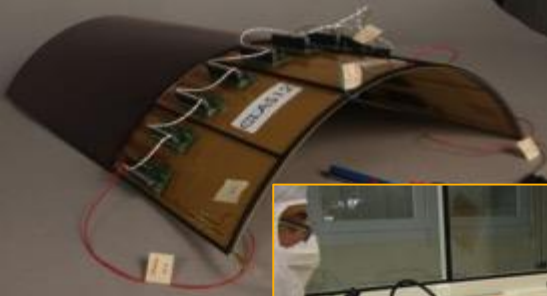

Tuile pour le trajectographe cylindrique

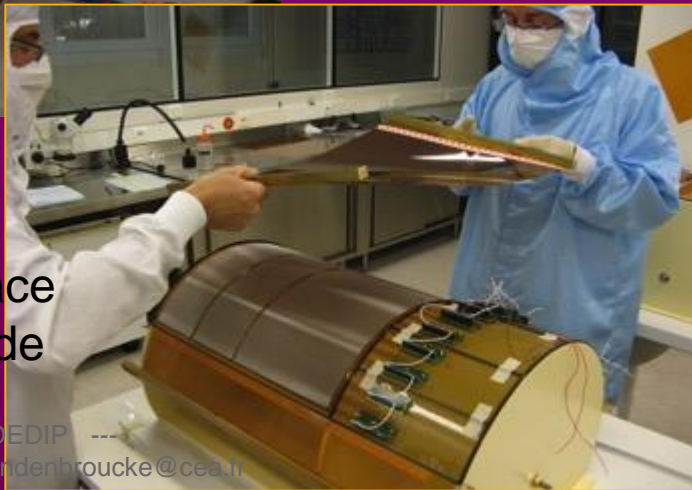

Mise en place de l'électrode de dérive

CEA/IRFU/DEDIP
maxence.vanderbroucke@cea.fr

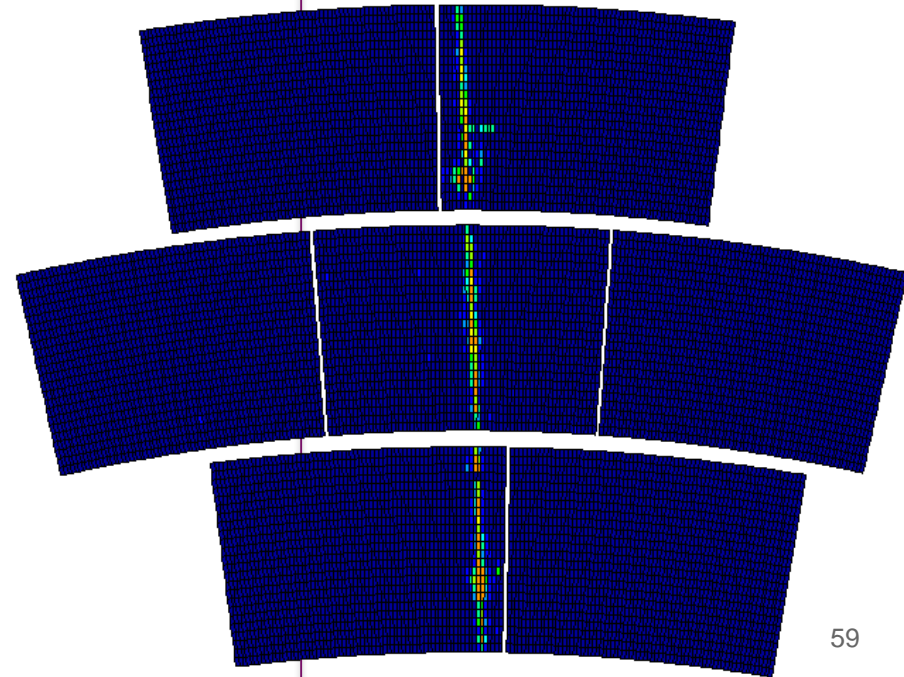

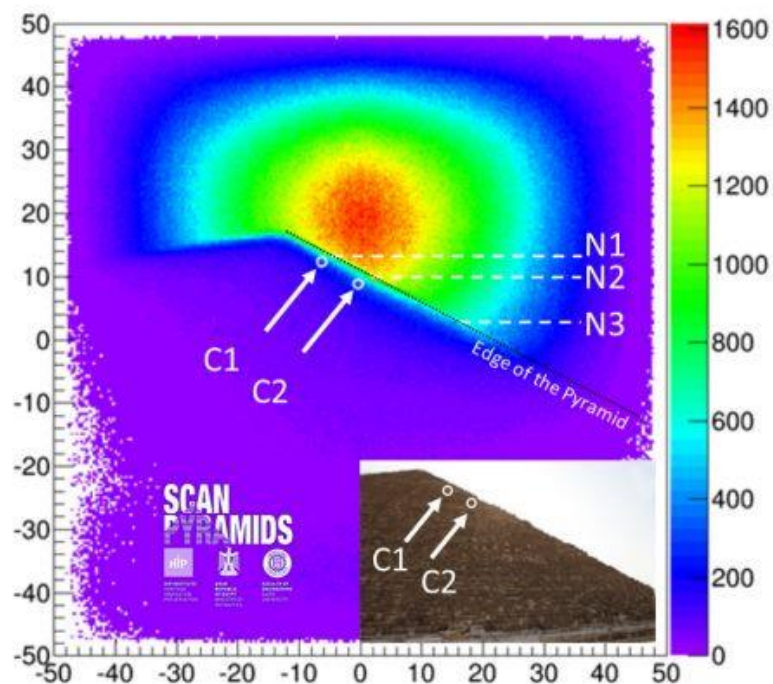
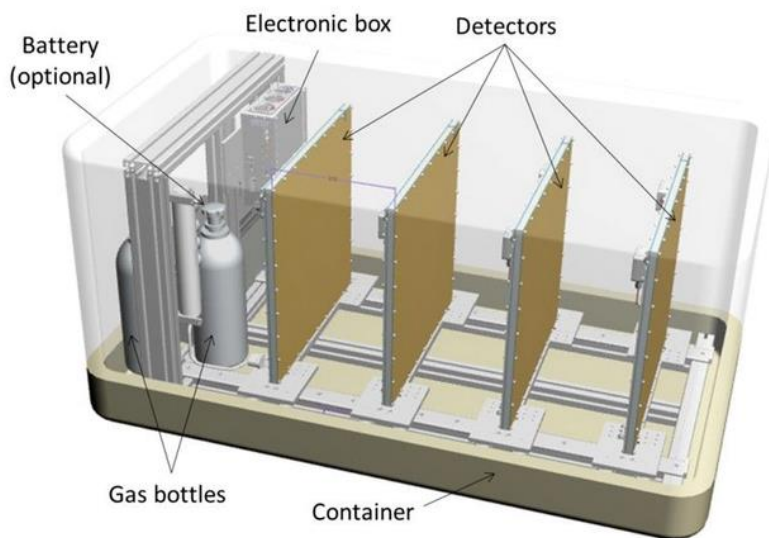
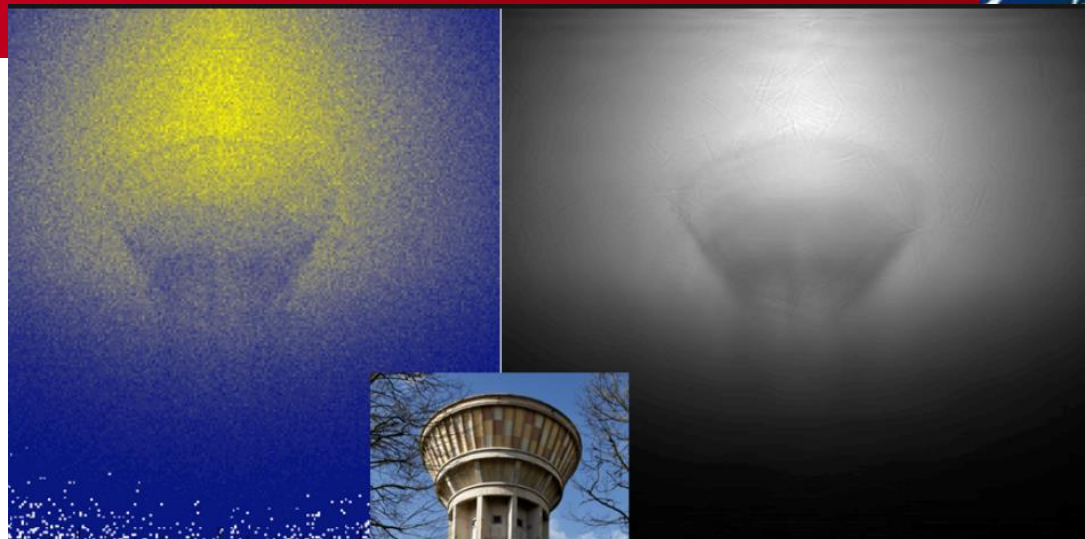
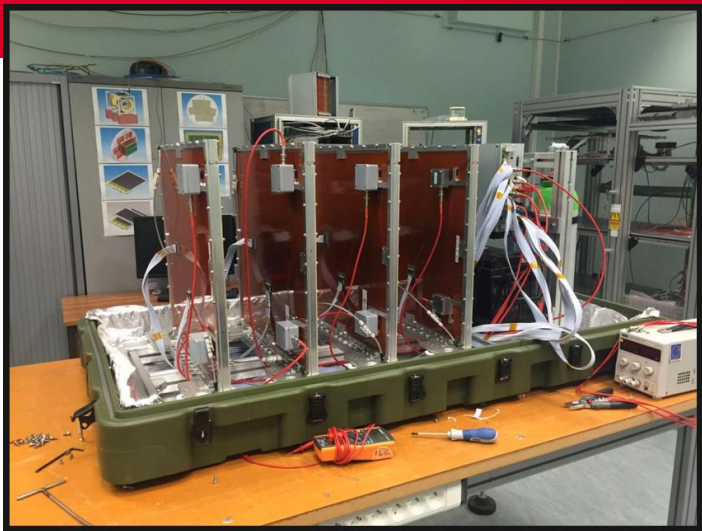

Cours 1 : Généralités

- Introduction générale sur l'importance de la mesure
- Qu'est-ce qu'une expérience de physique subatomique ?
- Que veut-on observer à propos d'une particule ?
- Architecture générale d'une expérience en physique subatomique

Cours 2 : Les détecteurs de particules

- Trajectographie :
 - Détecteurs Gazeux
 - Détecteurs au Silicium
- Calorimétrie
- Scintillation

Cours 3 : Exemple d'expériences

- Autour du Neutrino
- Nucléaire et Hadronique
- Rayons Cosmiques
- Antimatière



Rencontres d'été de physique de l'infiniment grand à l'infiniment petit 2017 : promotion Lise Meitner

17-27 juillet 2017
Europe/Paris timezone

Cours 3 : Exemple d'expériences

- **Autour du Neutrino**
- **Nucléaire et Hadronique**
- **Rayons Cosmiques**
- **Antimatière**

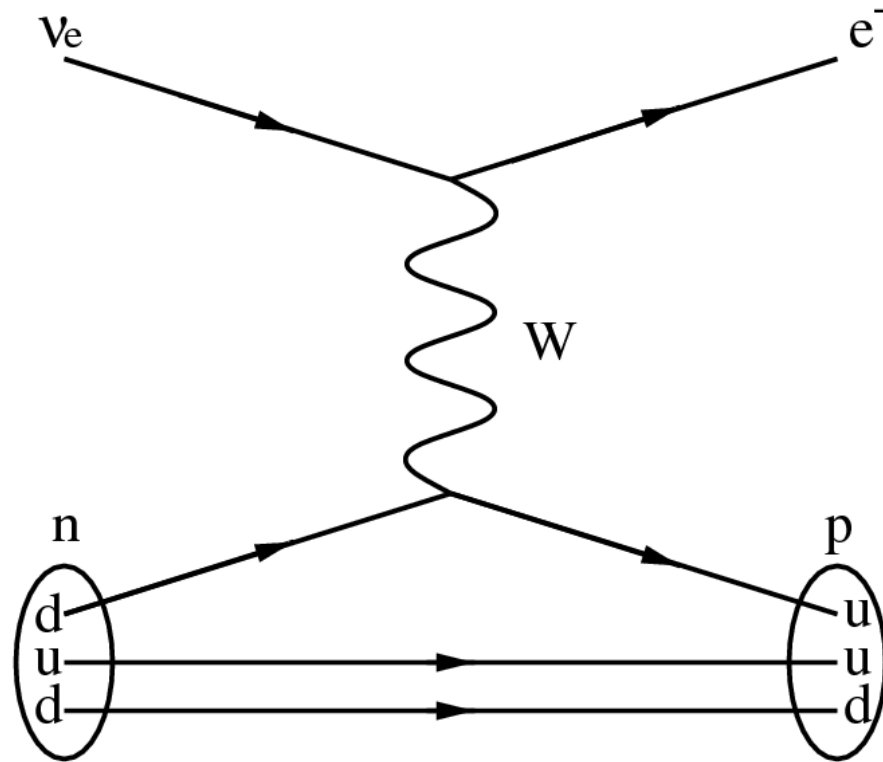

Super Kamiokande

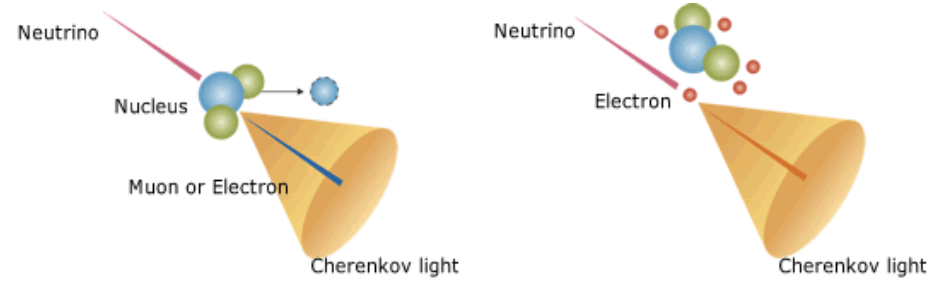
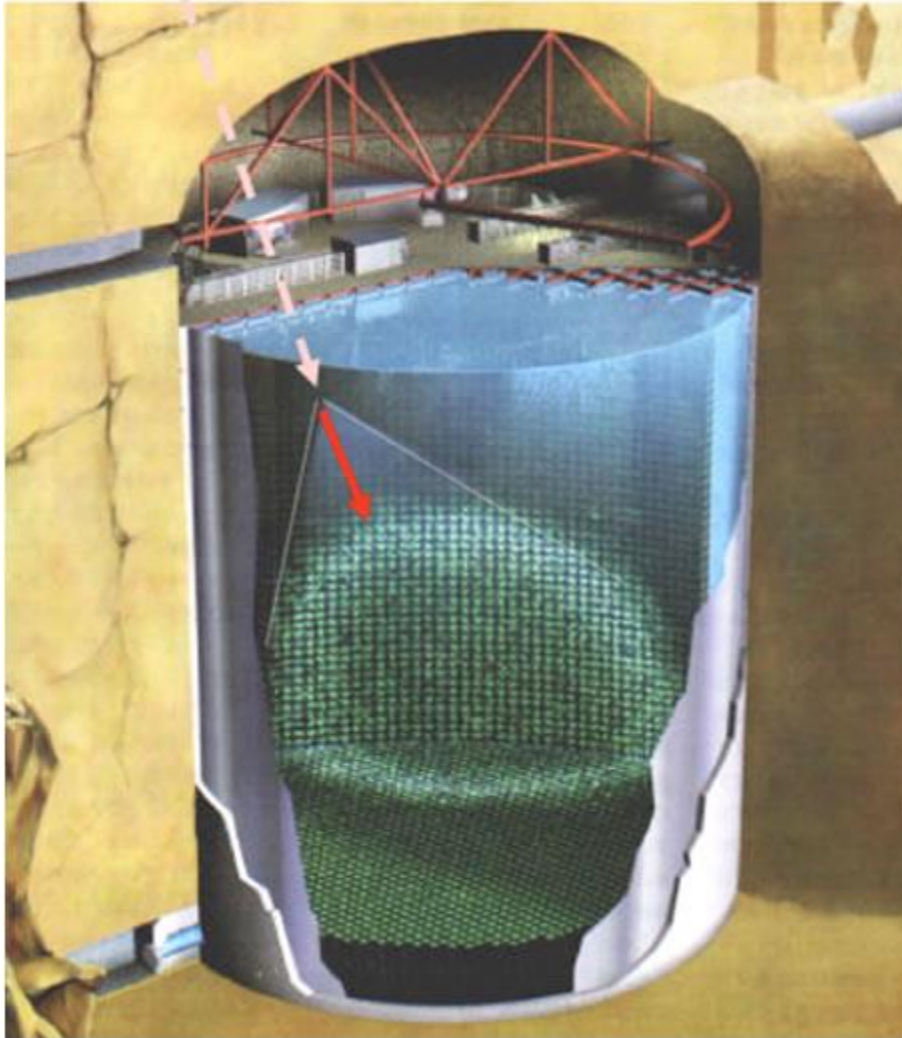

The generated charged particle emits the Cherenkov light.

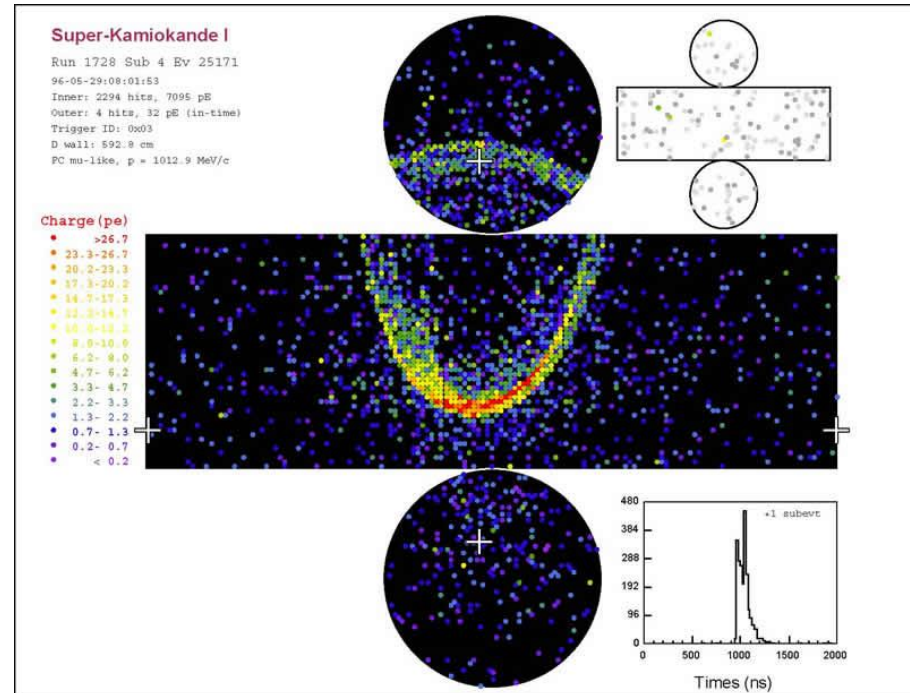

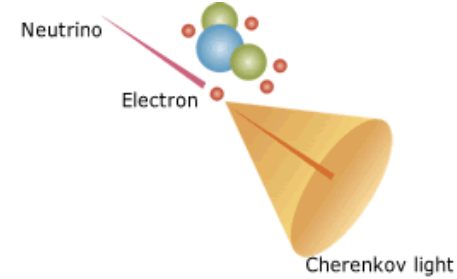
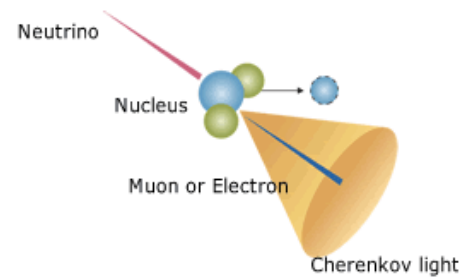
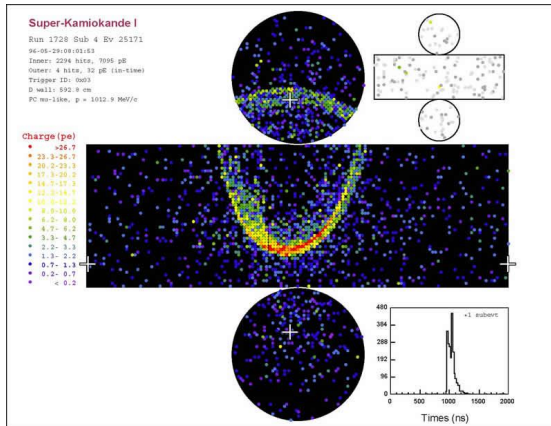

The generated charged particle emits the Cherenkov light.

Image du soleil en Neutrino Electronique

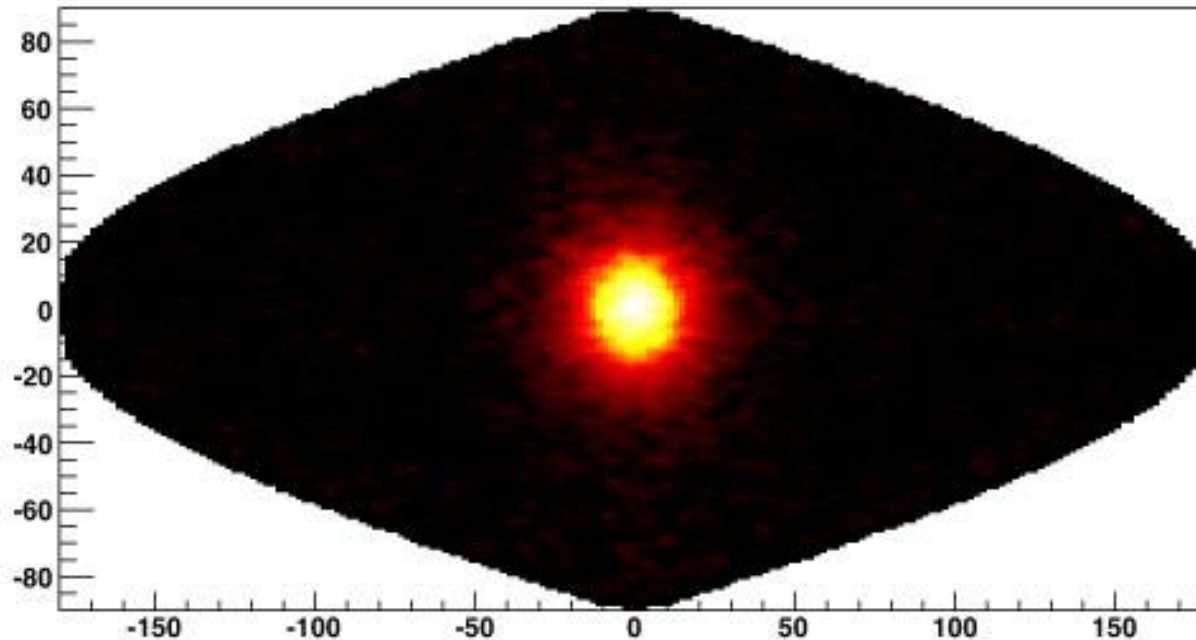

Antares

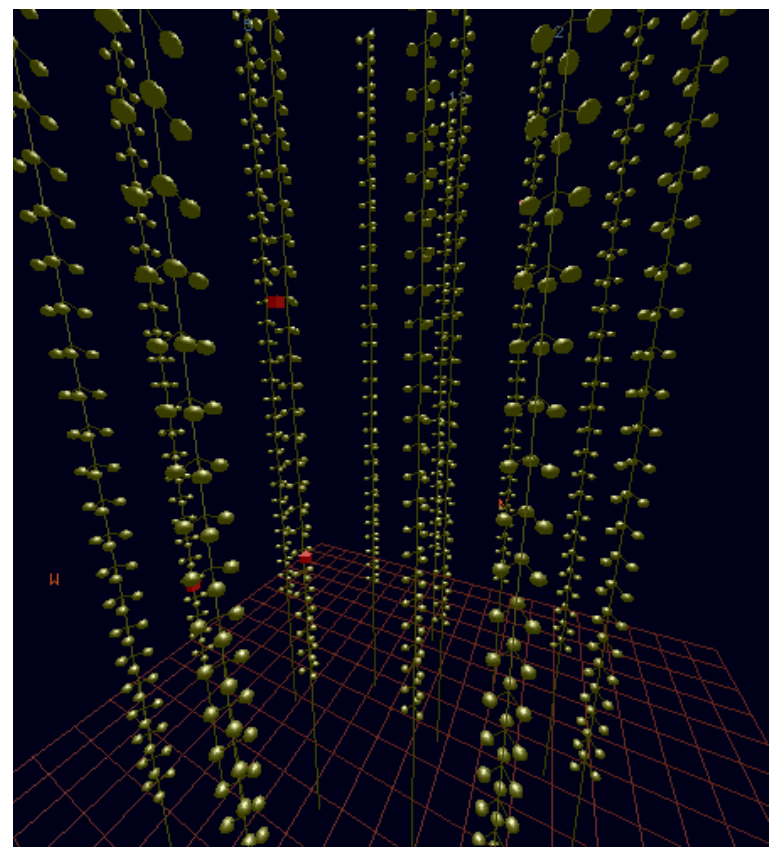

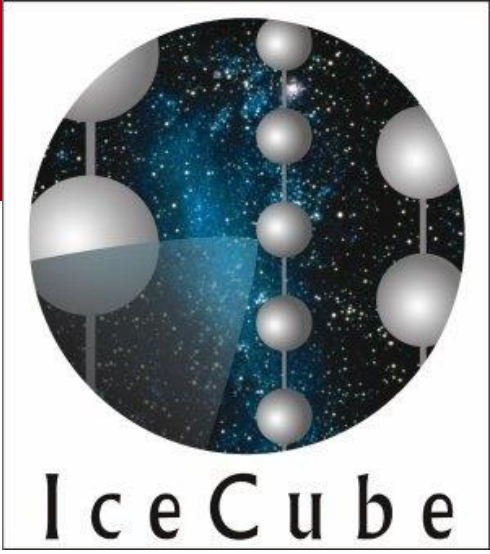
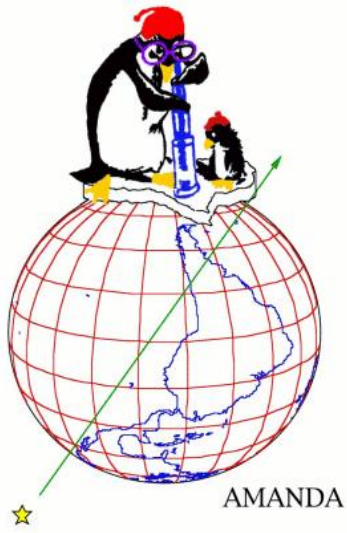

AMANDA

Antarctic **M**uon **A**nd **N**eutrino **D**etector **A**rray



South Pole



AMANDA



AMANDA-II

Depth

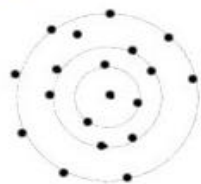

top view

200 m

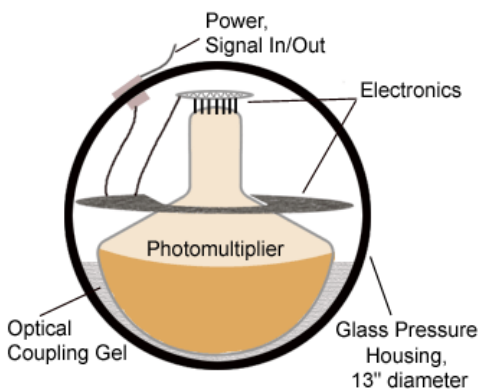
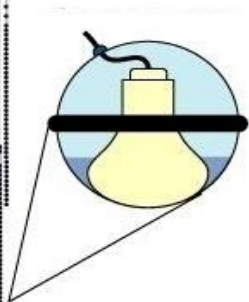
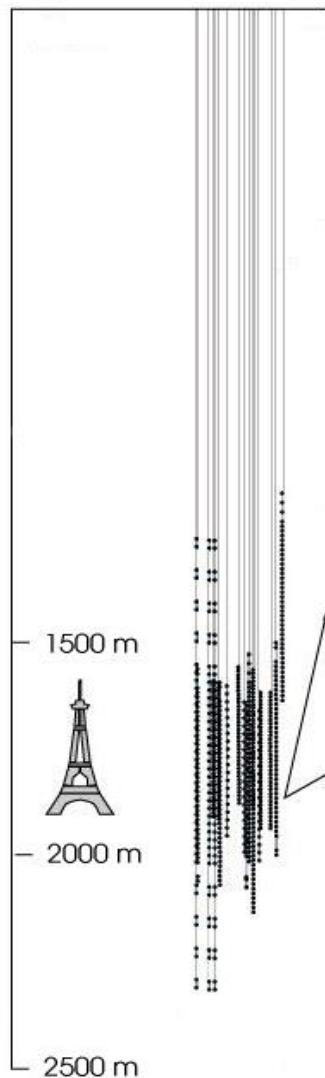

**Photomultipliers in the Ice,
looking downwards.
Ice is the detecting medium.**



Look for upwards going Muons from Neutrino Interactions.
Cherokov light propagating through the ice.

→ Find neutrino point sources in the universe !

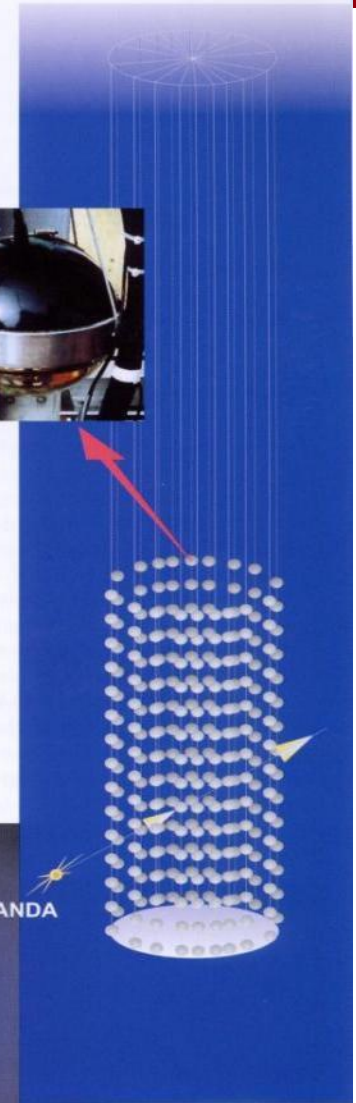
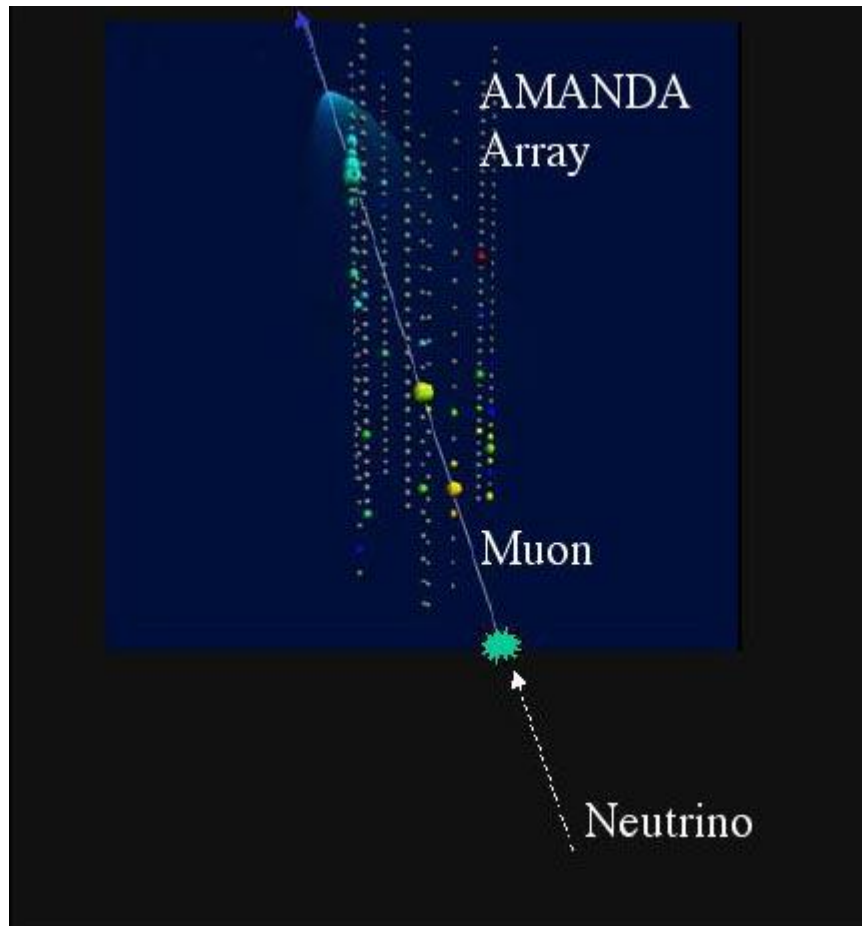



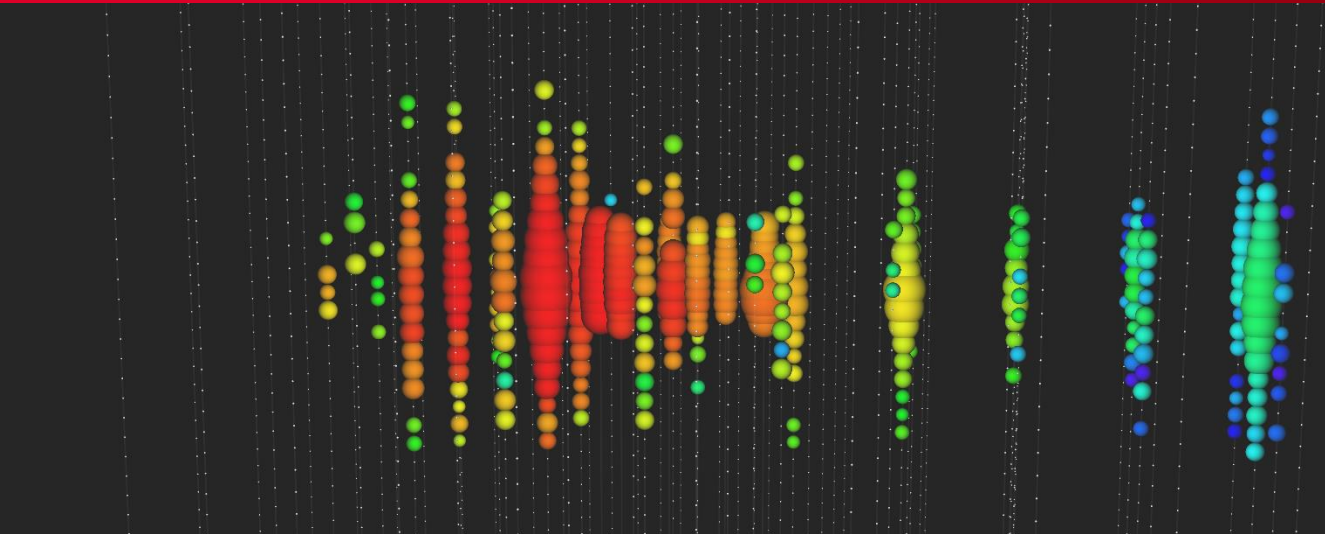

AMANDA – ICE CUBE

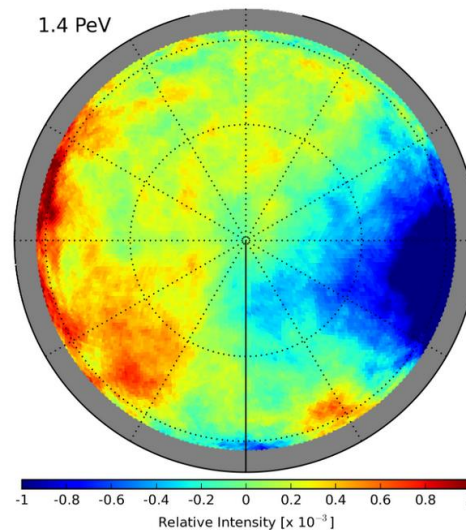
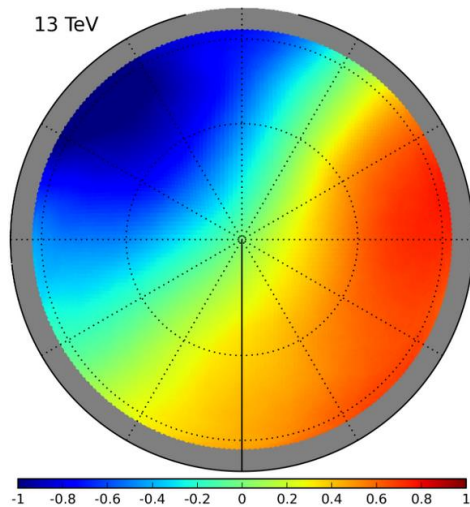
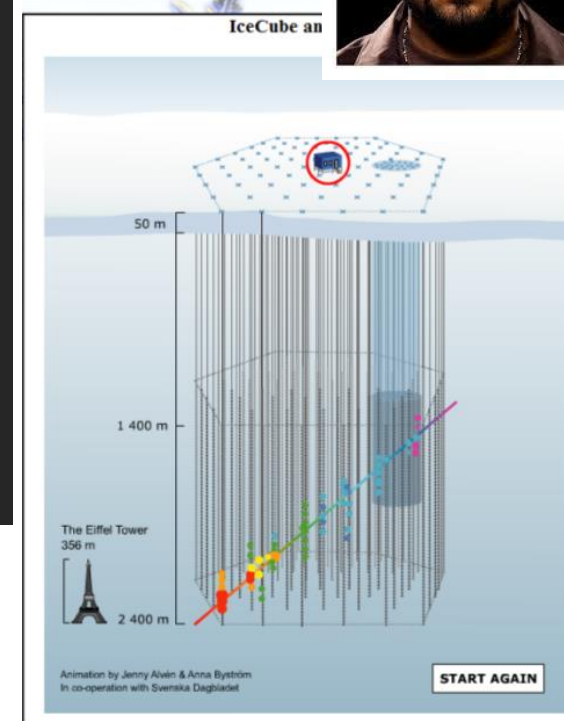

A very high energy neutrino detected in IceCube on November 12, 2010, with an energy of 71 TeV.
Image: IceCube Collaboration



Detector Design

-  1 gigaton of instrumented ice
-  5,160 light sensors, or digital optical modules (DOMs), digitize and time-stamp signals
-  1 square kilometer surface array, IceTop, with 324 DOMs
-  2 nanosecond time resolution
-  IceCube Lab (ICL) houses data processing and storage and sends 100 GB of data north by satellite daily

CERN Neutrino Gran Sasso (CNGS)

If neutrinos have mass:

Muon neutrinos produced at CERN.
See if tau neutrinos arrive in Italy.

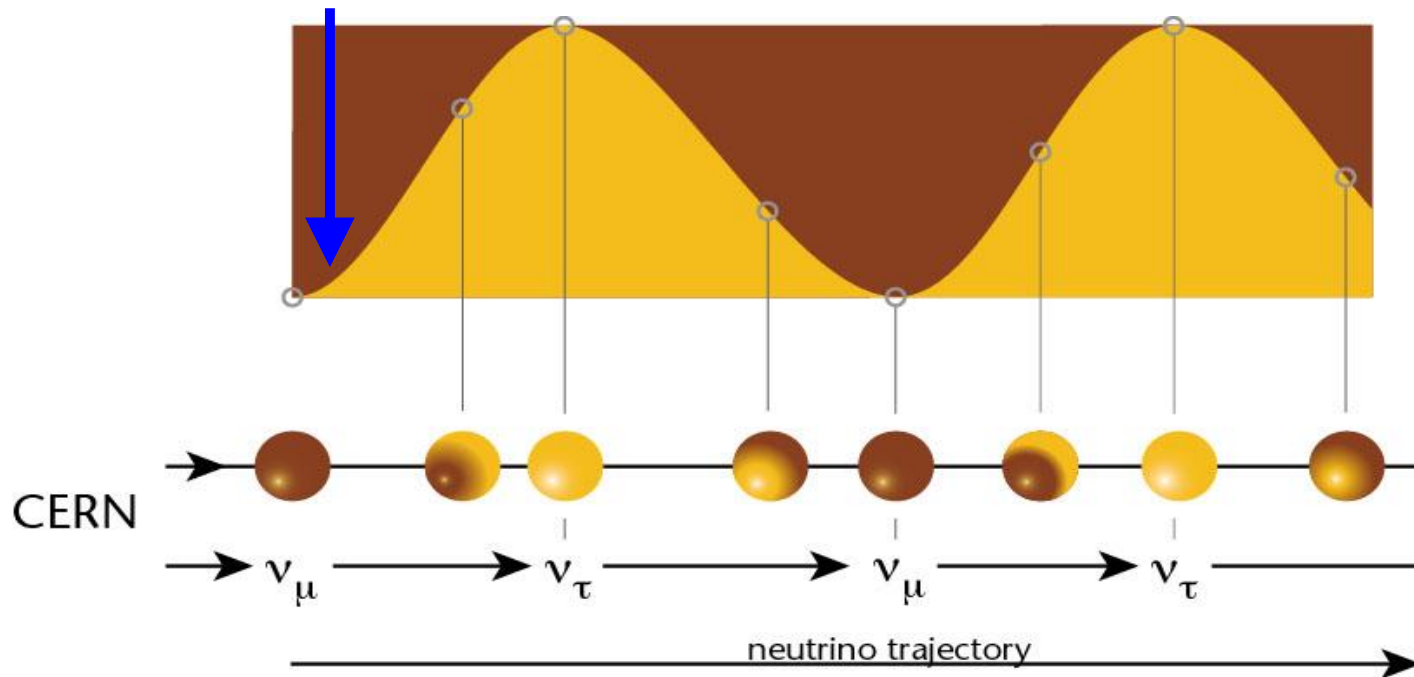
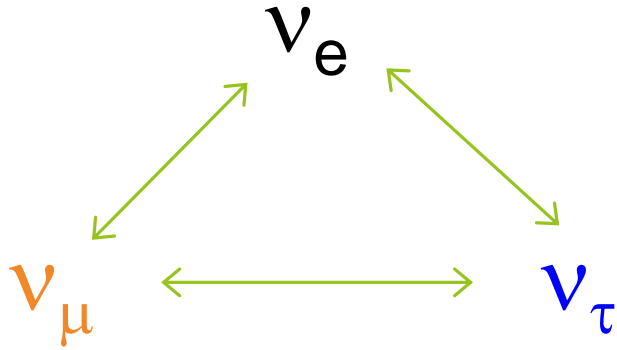

CNGS (CERN NEUTRINO GRAN SASSO)

- A LONG BASE-LINE NEUTRINO BEAM FACILITY (732KM)
- SEND N_M BEAM PRODUCED AT CERN
- DETECT N_T APPEARANCE IN OPERA EXPERIMENT AT GRAN SASSO

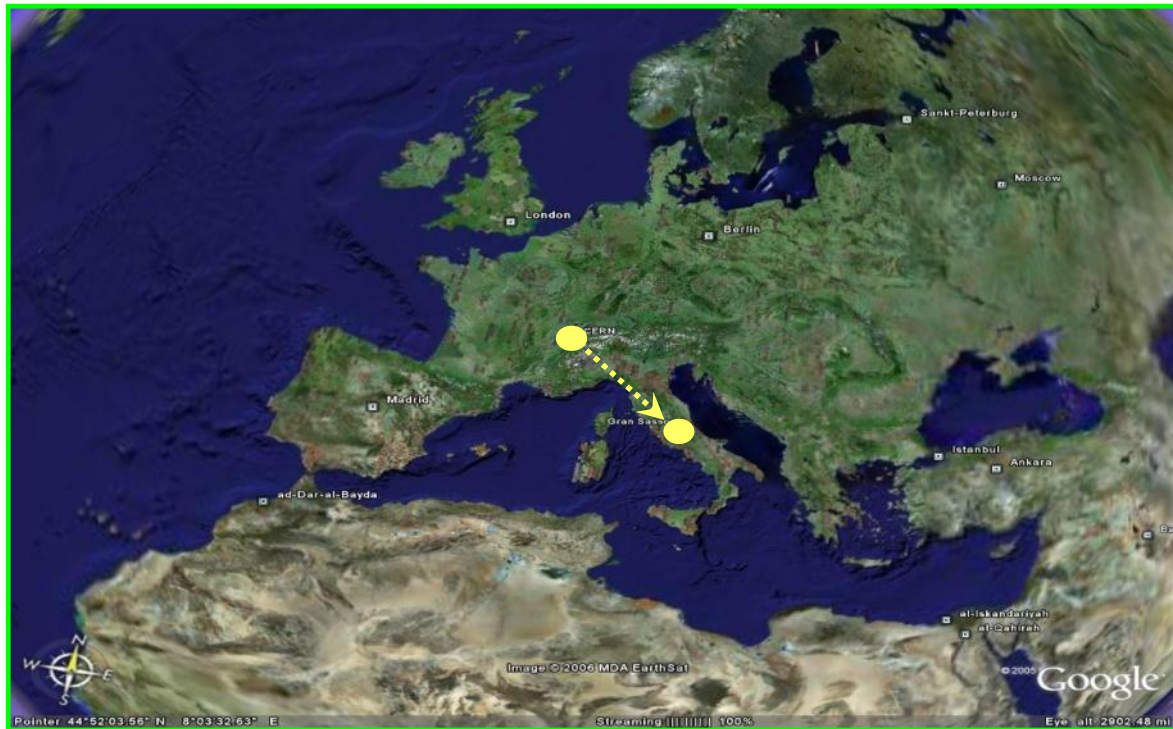

➔ direct proof of $\nu_\mu - \nu_\tau$ oscillation (appearance experiment)

CNGS

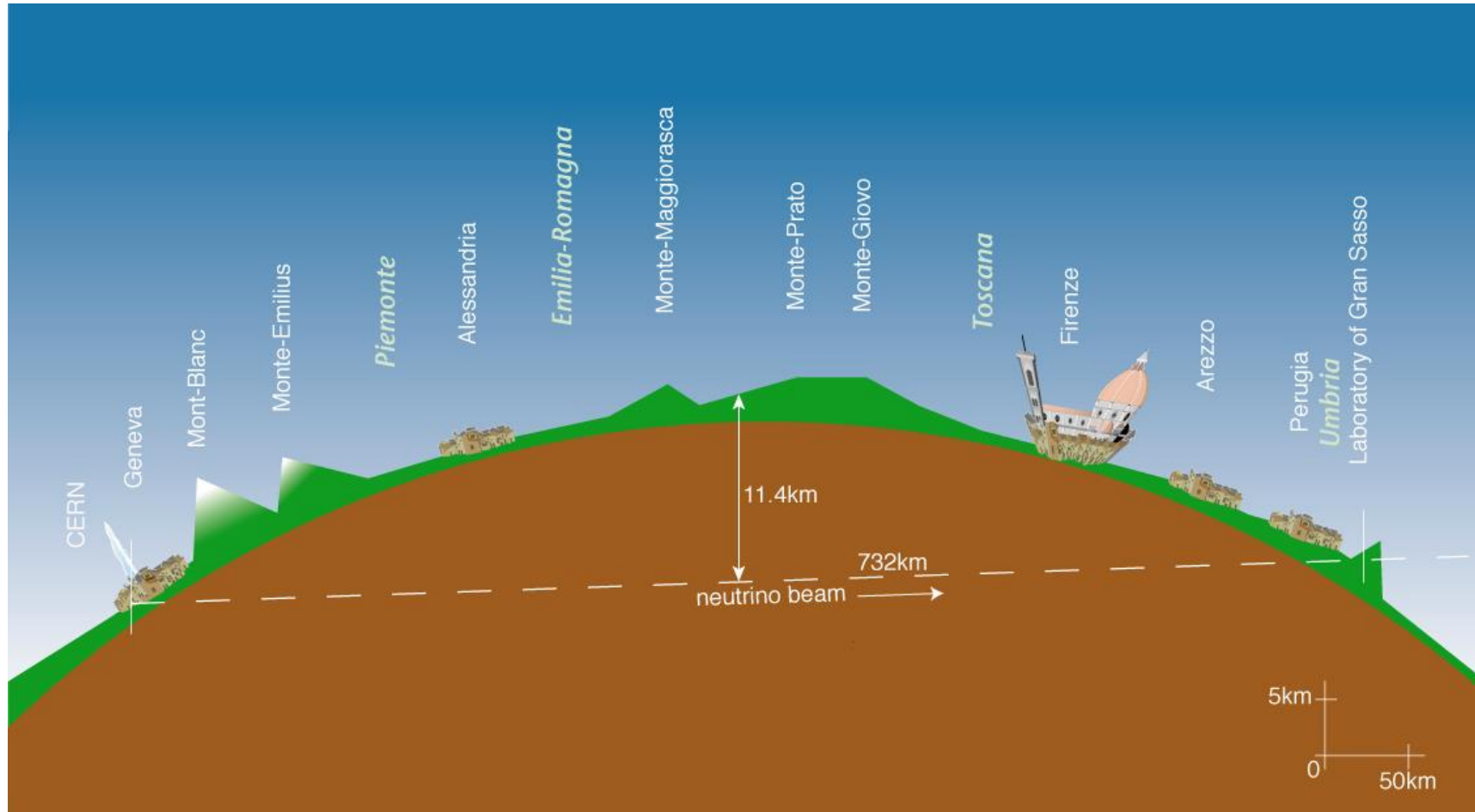

For 1 day of CNGS operation, we expect:

protons on target

$$2 \times 10^{17}$$

pions / kaons at entrance to decay tunnel

$$3 \times 10^{17}$$

ν_{μ} in direction of Gran Sasso

$$10^{17}$$

ν_{μ} in 100 m² at Gran Sasso

$$3 \times 10^{12}$$

ν_{μ} events per day in OPERA

$$\approx 25 \text{ per day}$$

ν_{τ} events (from oscillation)

$$\approx 2 \text{ per year}$$

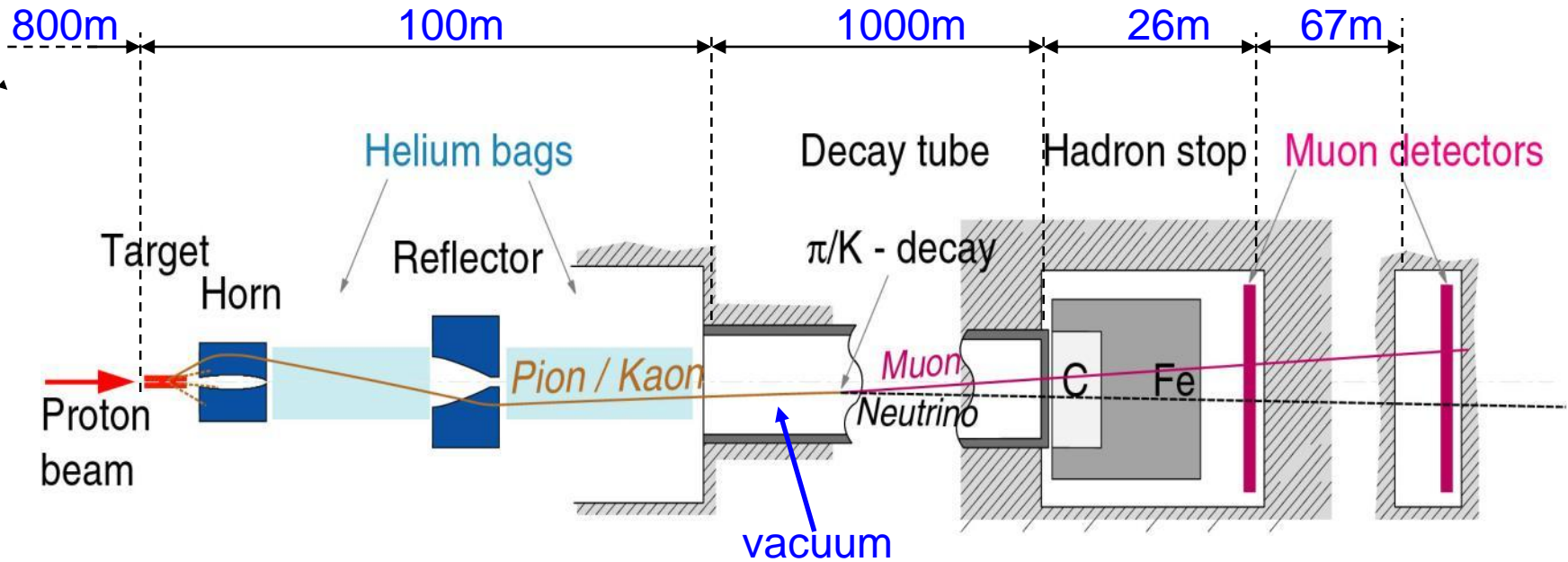

CNGS

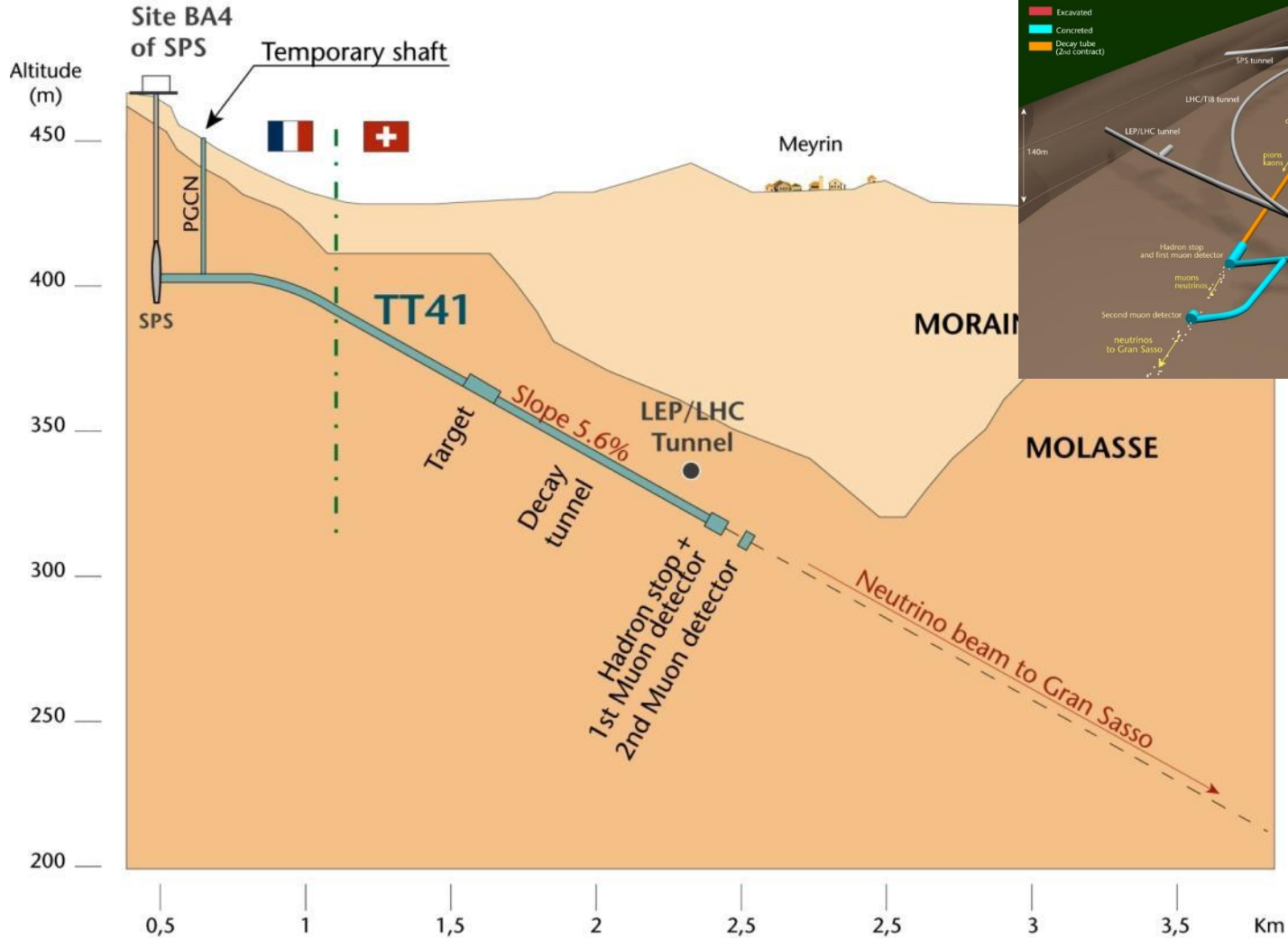

$$\nu_{\tau} N \longrightarrow \tau^{-} X$$

$$\tau^{-} \rightarrow \mu^{-} \nu_{\mu} \bar{\nu}_{\tau} \quad \text{with} \quad BR = 17.36 \pm 0.05\% \quad (1)$$

$$\tau^{-} \rightarrow e^{-} \nu_e \bar{\nu}_{\tau} \quad \text{with} \quad BR = 17.85 \pm 0.05\% \quad (2)$$

$$\tau^{-} \rightarrow h^{-} (n\pi^0) \bar{\nu}_{\tau} \quad \text{with} \quad BR = 49.52 \pm 0.07\% \quad (3)$$

$$\tau^{-} \rightarrow 2h^{-} h^{+} (n\pi^0) \bar{\nu}_{\tau} \quad \text{with} \quad BR = 15.19 \pm 0.08\% \quad (4)$$

<https://arxiv.org/pdf/1305.2513.pdf>

Basic unit: brick

56 Pb sheets + 56 photographic films (emulsion sheets)

Lead plates: massive target

Emulsions: micrometric precision

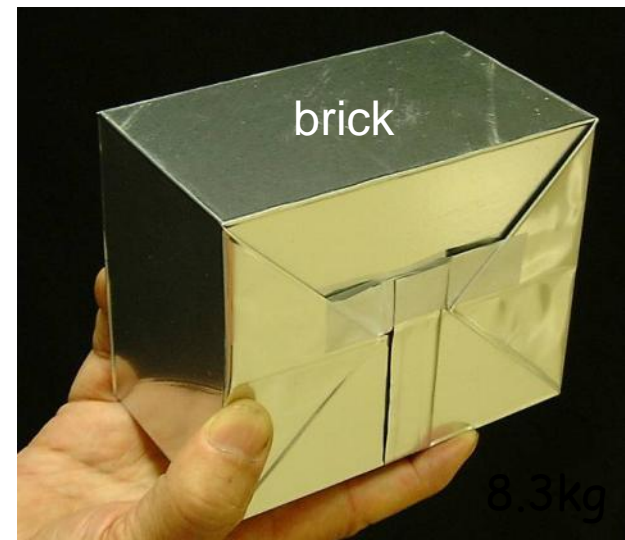
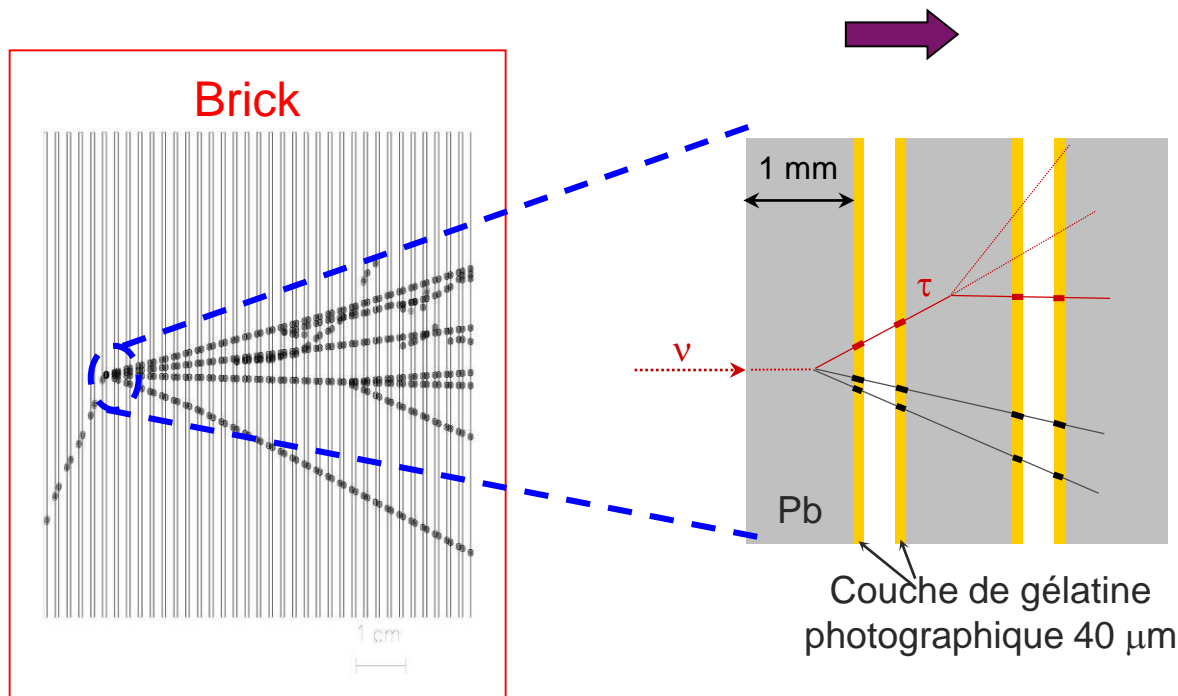

10.2 x 12.7 x 7.5 cm³



31 target planes / supermodule

In total: 206336 bricks, 1766 tons

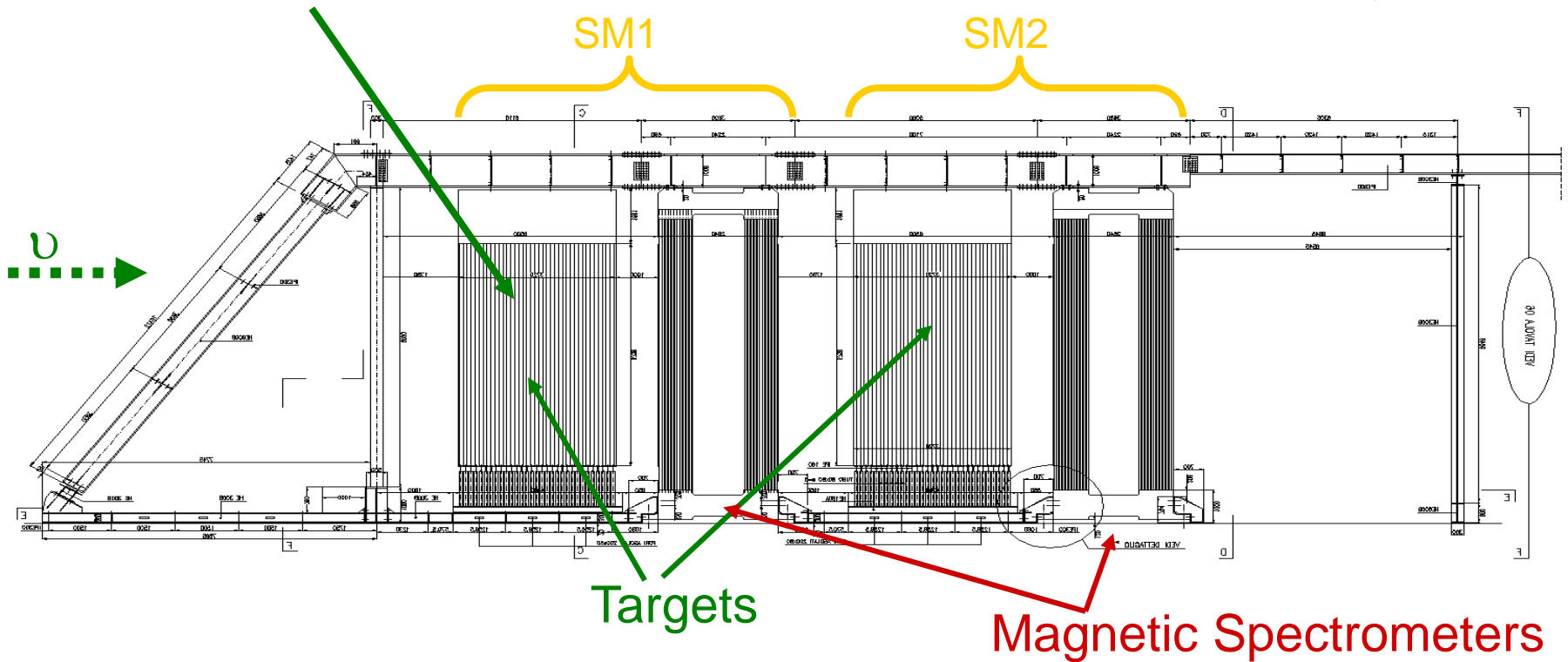

First observation of CNGS beam neutrinos : August 18th, 2006



Second Super-module

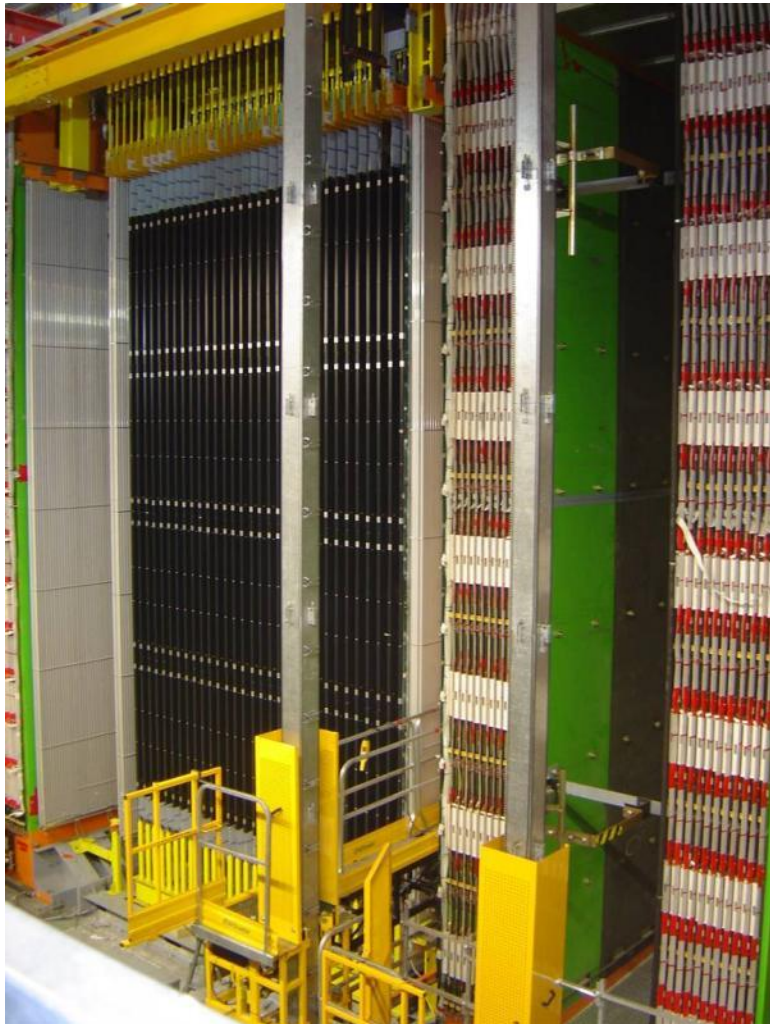

Scintillator planes 5900 m²
8064 7m long drift tubes

CEA/IRFU/DEDIP
maximilien.vanderbrugghe@cea.fr

Details of the first spectrometer

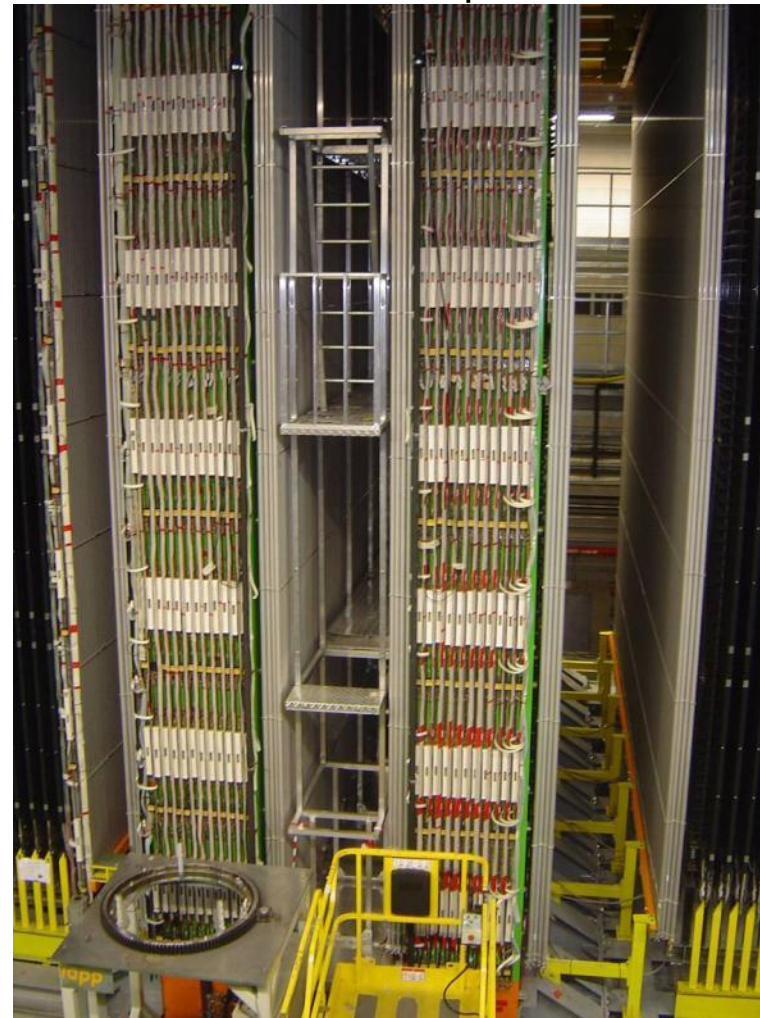

3050 m² Resistive Plate Counters
2000 tons of iron for the two magnets

The Brick Manipulator System (BMS) prototype:
a lot of fun for children and adults !

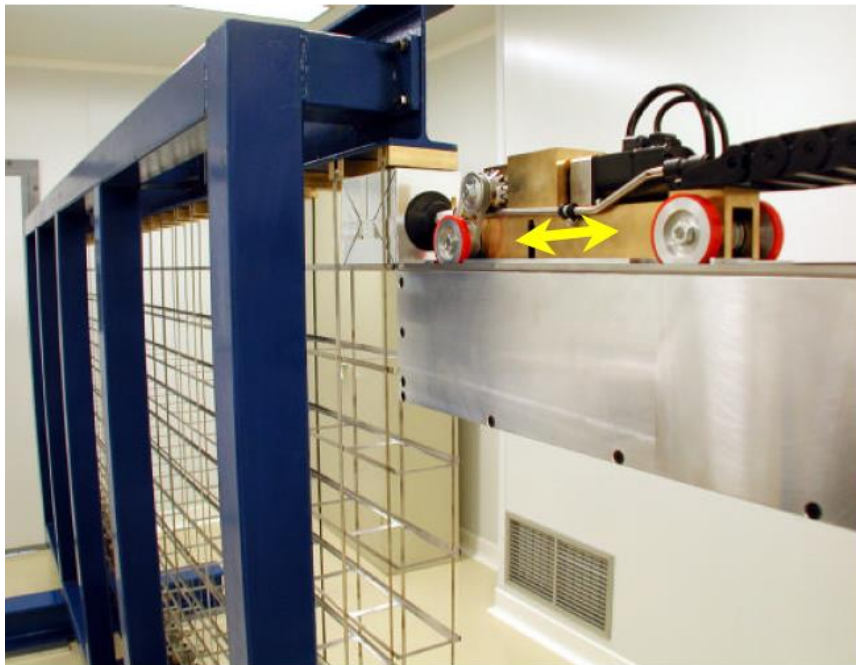

Tests with the prototype wall

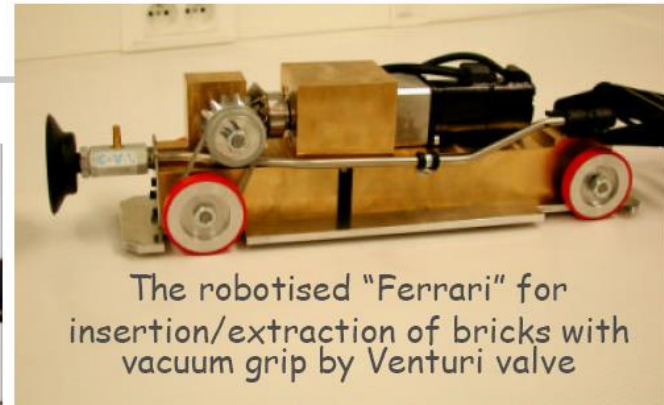

The robotised "Ferrari" for
insertion/extraction of bricks with
vacuum grip by Venturi valve



"Carousel" brick dispensing
and storage system

Physique Hadronique

COMPASS et CLAS12

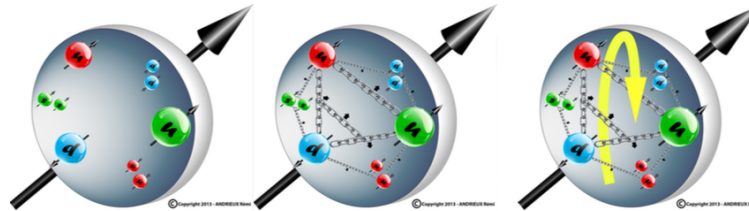

Différentes contributions

$$\frac{1}{2} = \frac{1}{2} (\Delta u + \Delta d + \Delta s) + \Delta G + L_g + L_q$$

Spin des quarks
 $\Delta\Sigma \sim 0.3$

Spin des gluons
 $|\Delta G| < 0.5$

Moments orbitaux
 $L_{q+g} = ??$

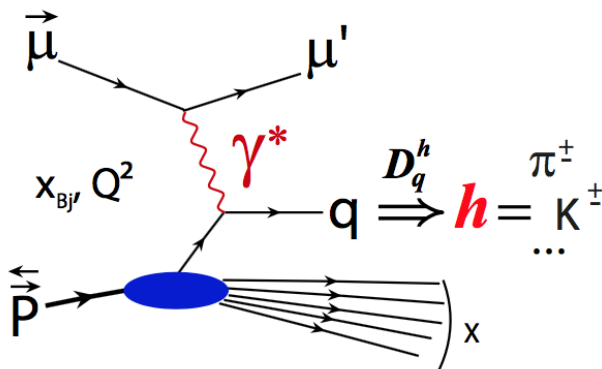

Section efficace DIS

$$\frac{d^2 \sigma}{dx dQ^2} = \underbrace{c_1 F_1(x, Q^2) + c_2 F_2(x, Q^2)}_{\text{fonctions de structure non-polarisées}} + \underbrace{c_3^{s,S} g_1(x, Q^2) + c_4^{s,S} g_2(x, Q^2)}_{\text{fonctions de structure polarisées}}$$

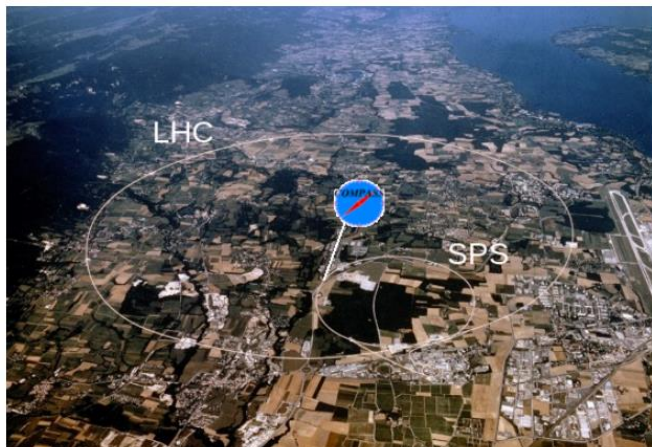

- Faisceau polarisé de μ^+ du SPS
 $1 \cdot 10^8 / 2 \cdot 10^8 \mu$ par déversement de ~ 10 s
 $200 \text{ GeV} / 160 \text{ GeV}$
 $P_\mu = 80\%$

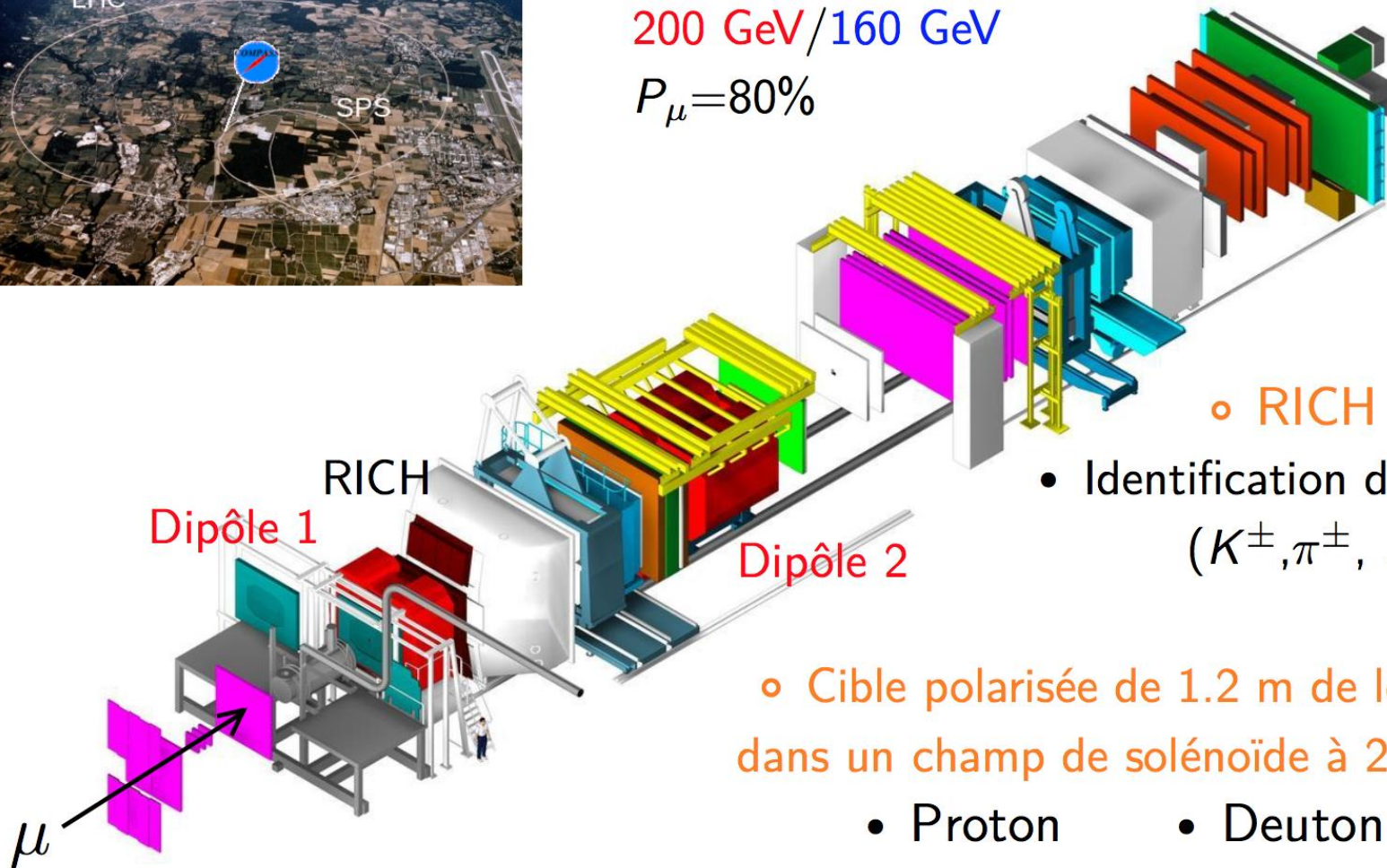

- RICH :
 - Identification des hadrons (K^\pm, π^\pm, \dots)

- Cible polarisée de 1.2 m de long dans un champ de solénoïde à 2.5 T
 - Proton
 - Deuton

Diffusion Compton profondément virtuelle (DVCS)

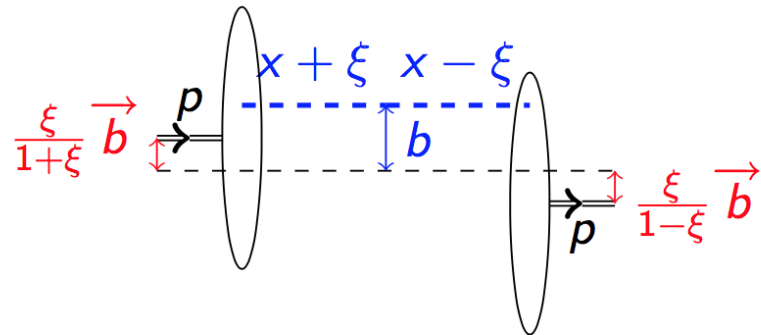
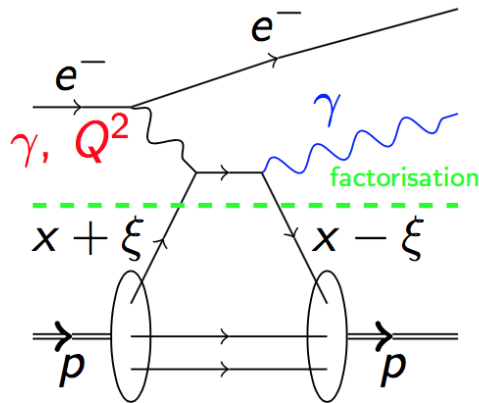

Vers une visualisation en 3d du nucléon !

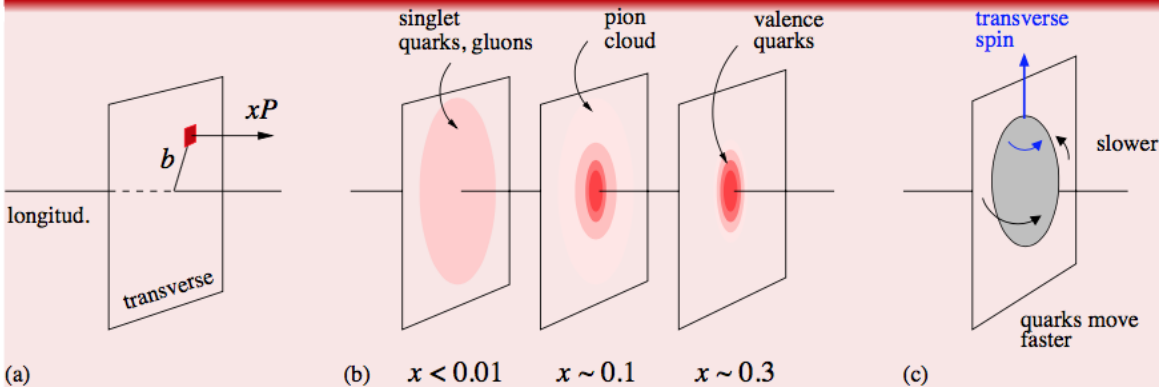

C. Weiss,
AIP Conf.
Proc. 1149,
150 (2009)

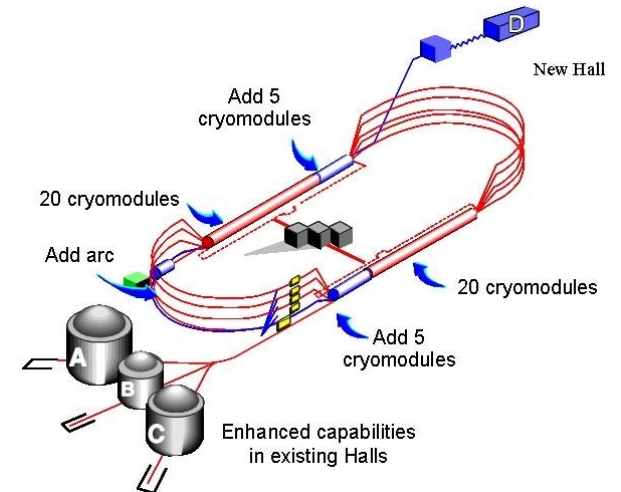

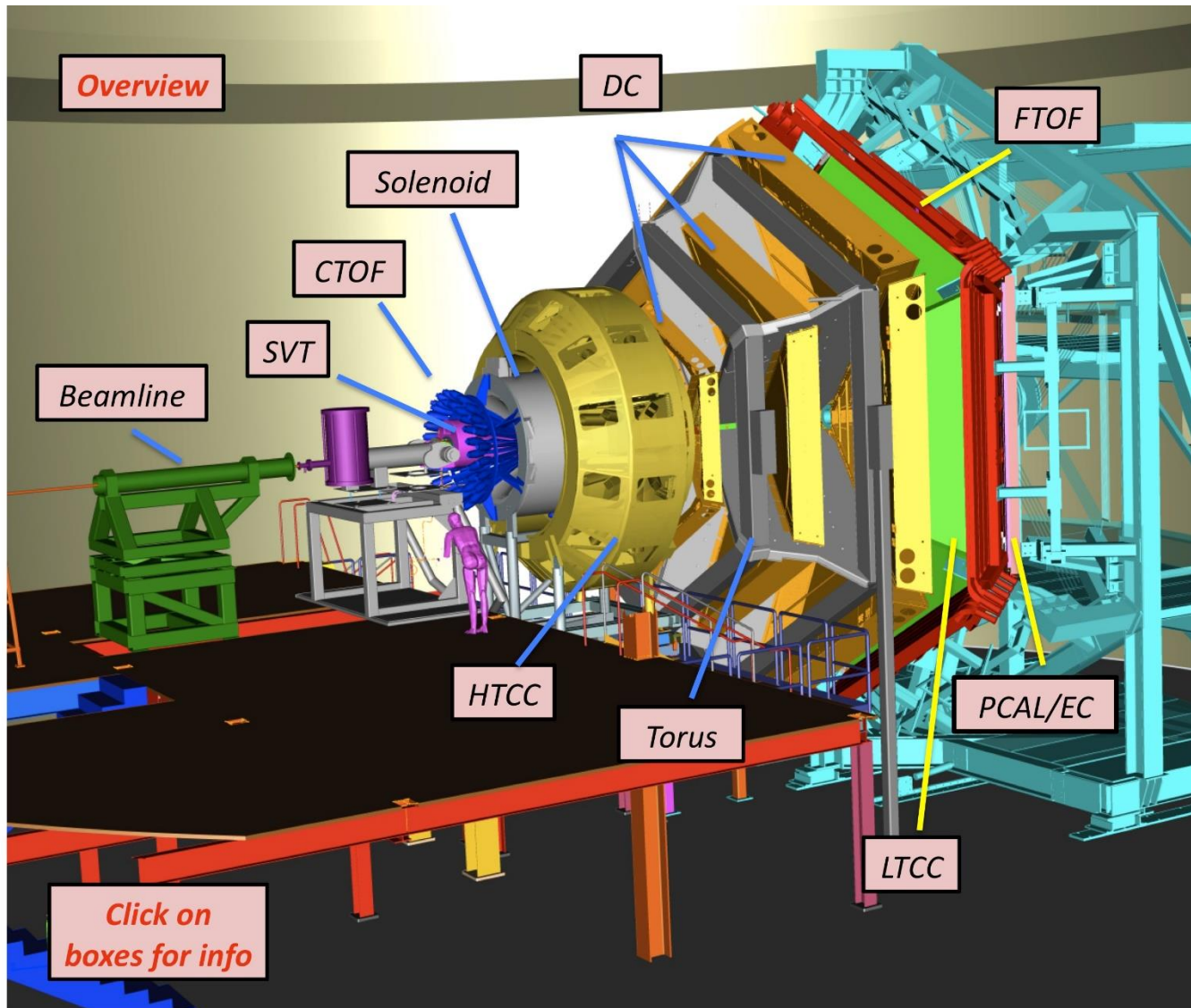

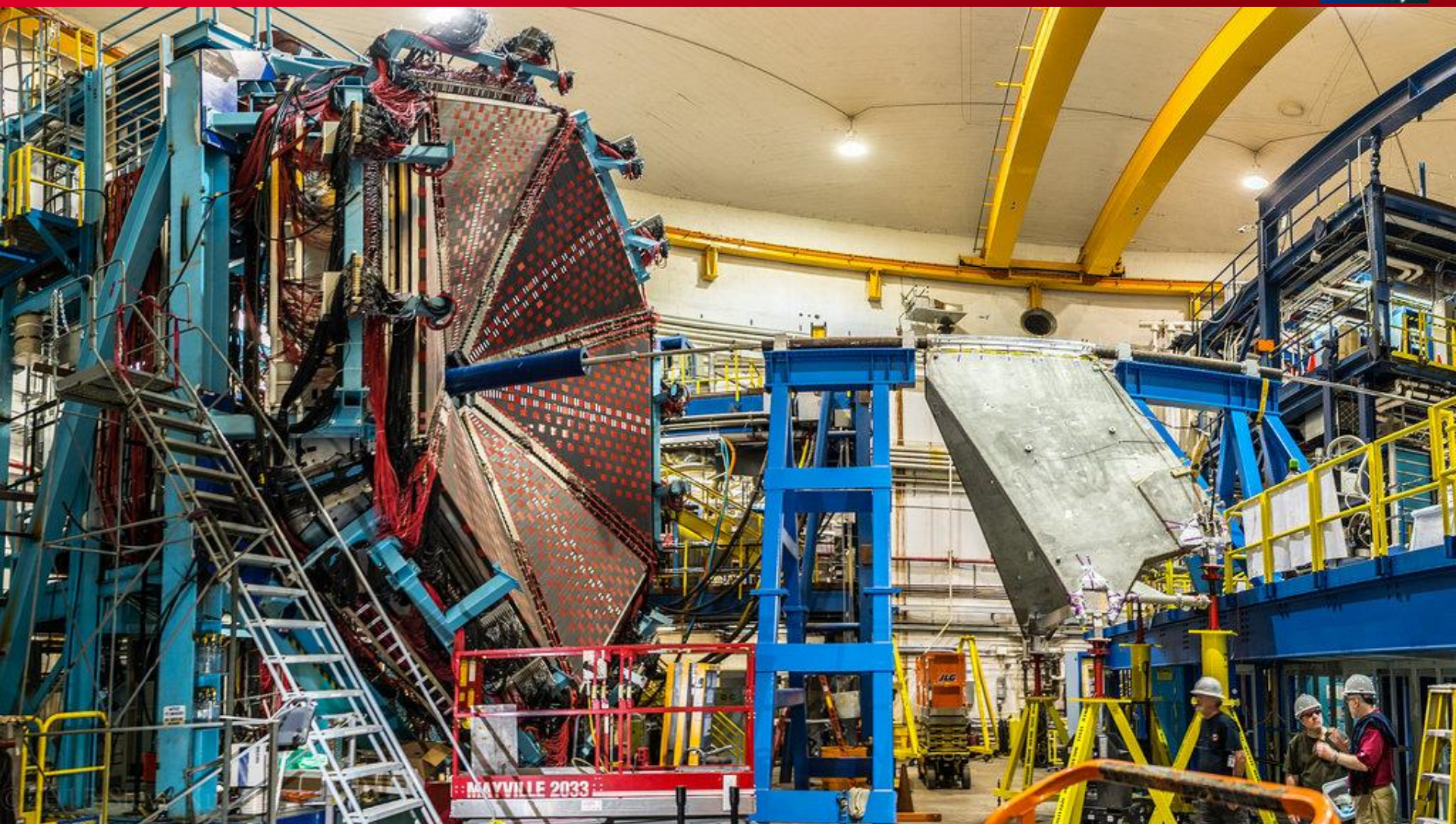



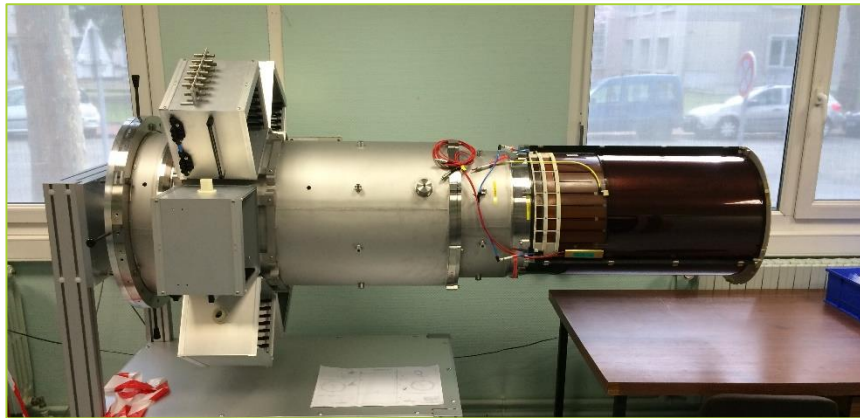
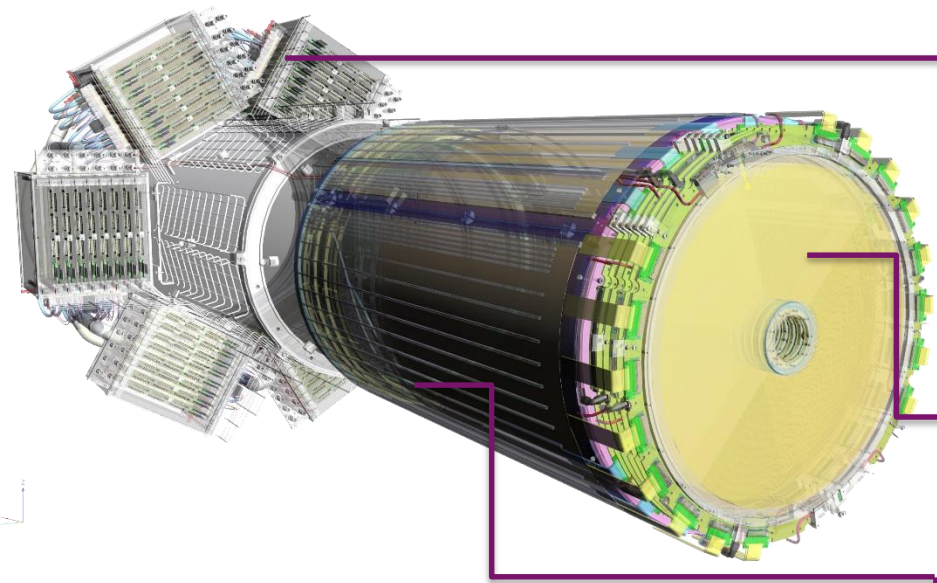

- ▶ 4 m² of Micromegas detectors to be installed in 2017
- ▶ DREAM based Front-End Electronics
- ▶ Remote off-detector frontend electronics connected with 2m micro-coaxial cables

Forward Detectors

- ▶ High particle rate (30MHz) => Fast detectors
- ▶ Resistive strips divided in 2 zones inner/outer
- ▶ Dimensions: 6x 430 mm diameter disk with a 50 mm diameter hole at the center

Cylindrical Barrel

- ▶ Low momentum particles => Light Detectors
- ▶ Limited space of ~10 cm for 6 layers
- ▶ High magnetic field (5T)
- ▶ Phase 1 (2016) : 2 Layers (6 Det. of 120°)
- ▶ Phase 2 (2017) : 6 Layers (18 Det.)

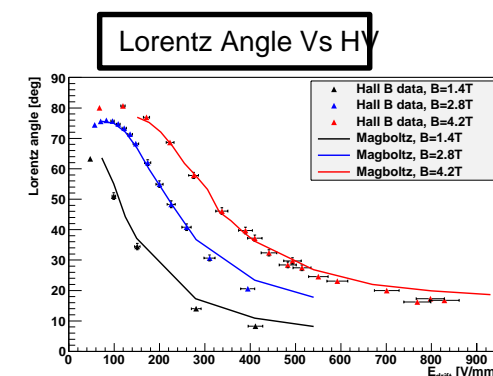
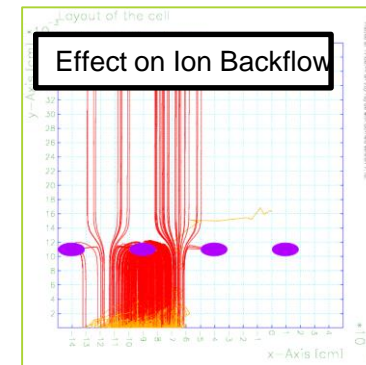
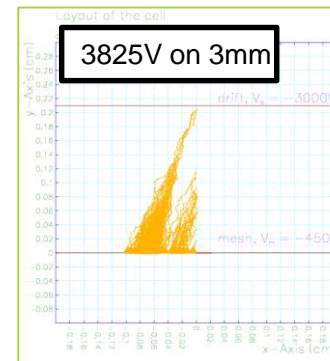
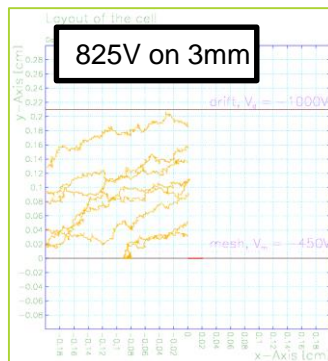
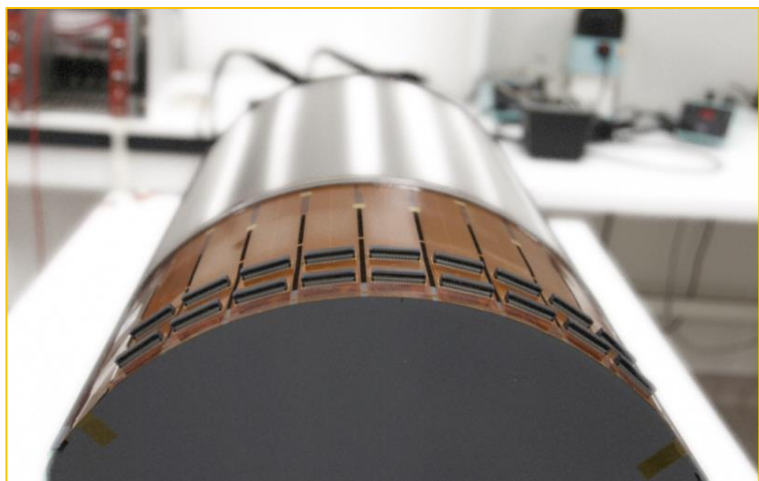

=> Clas-note 2007-004: Simulations of Micromegas detectors for the CLAS12 experiment (S. Procureur)

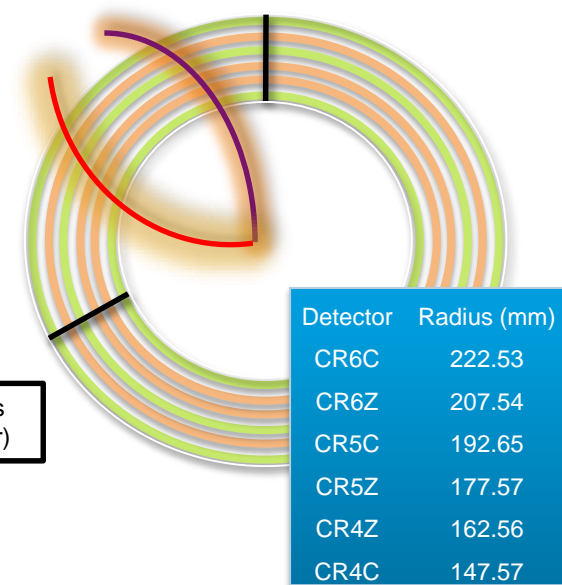



ALICE

A heavy Ion Experiment at the LHC

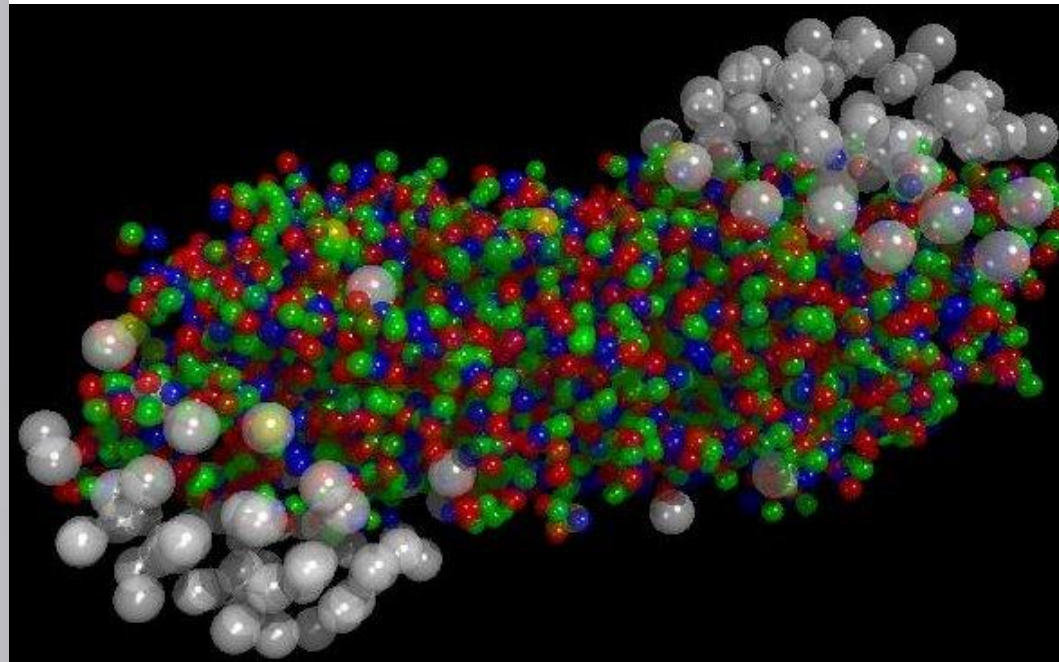
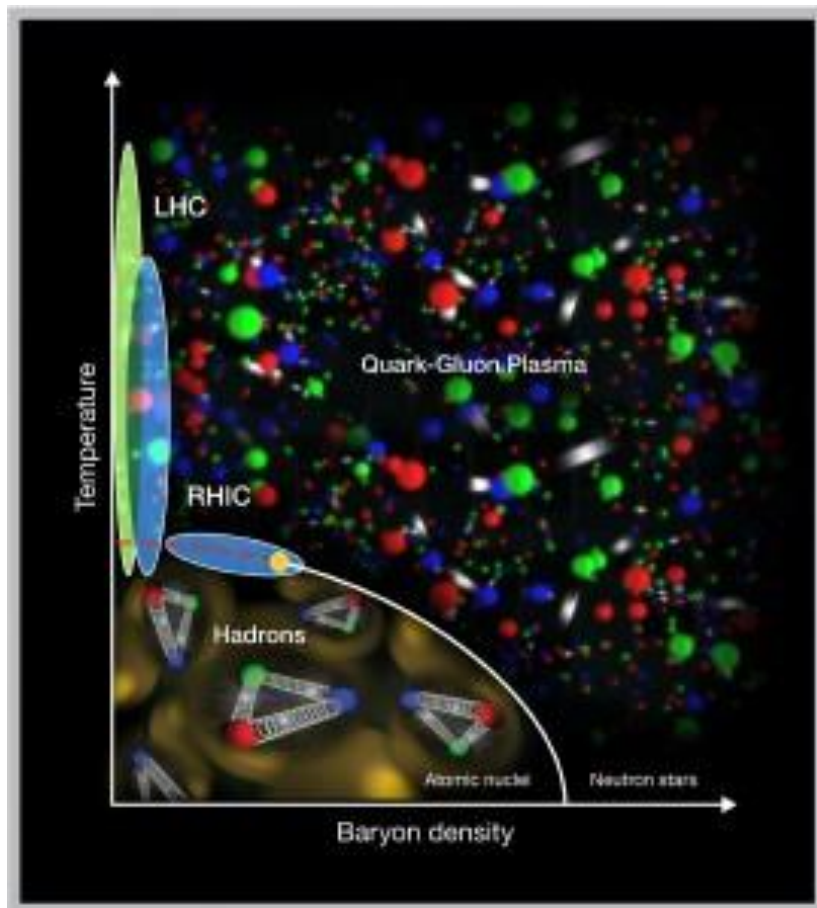

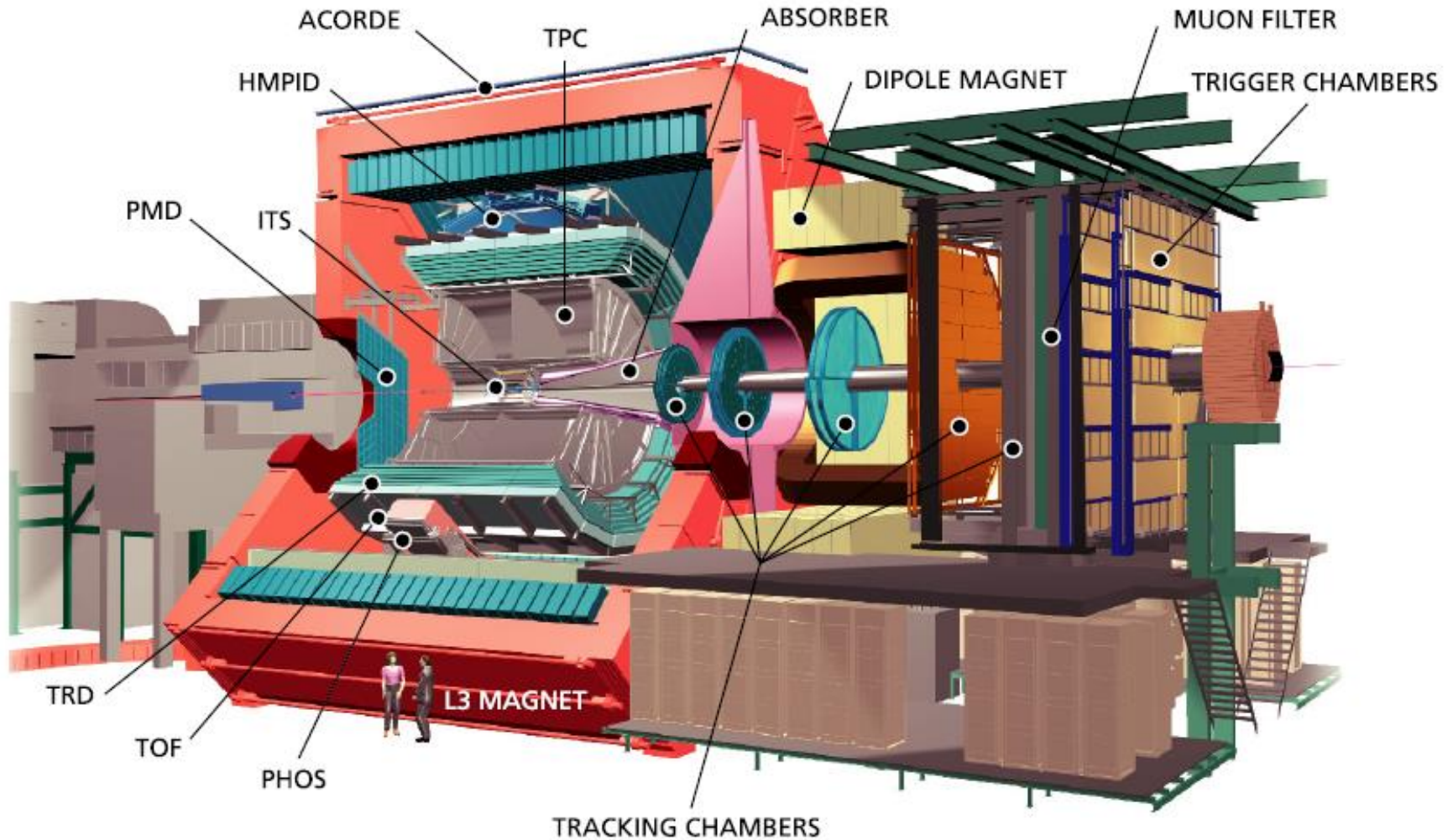

Alice uses ~ all known techniques!

TPC + ITS
(dE/dx)

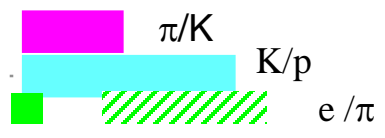

TOF



HMPID
(RICH)



0 1 2 3 4 5 p (GeV/c)

TPC (rel. rise) $\pi/K/p$

TRD

PHOS

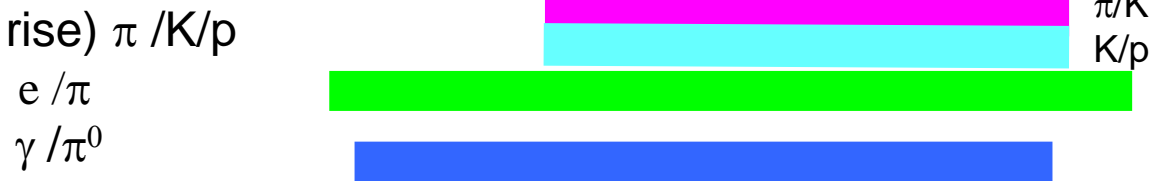

1 10 100 p (GeV/c)

ALICE

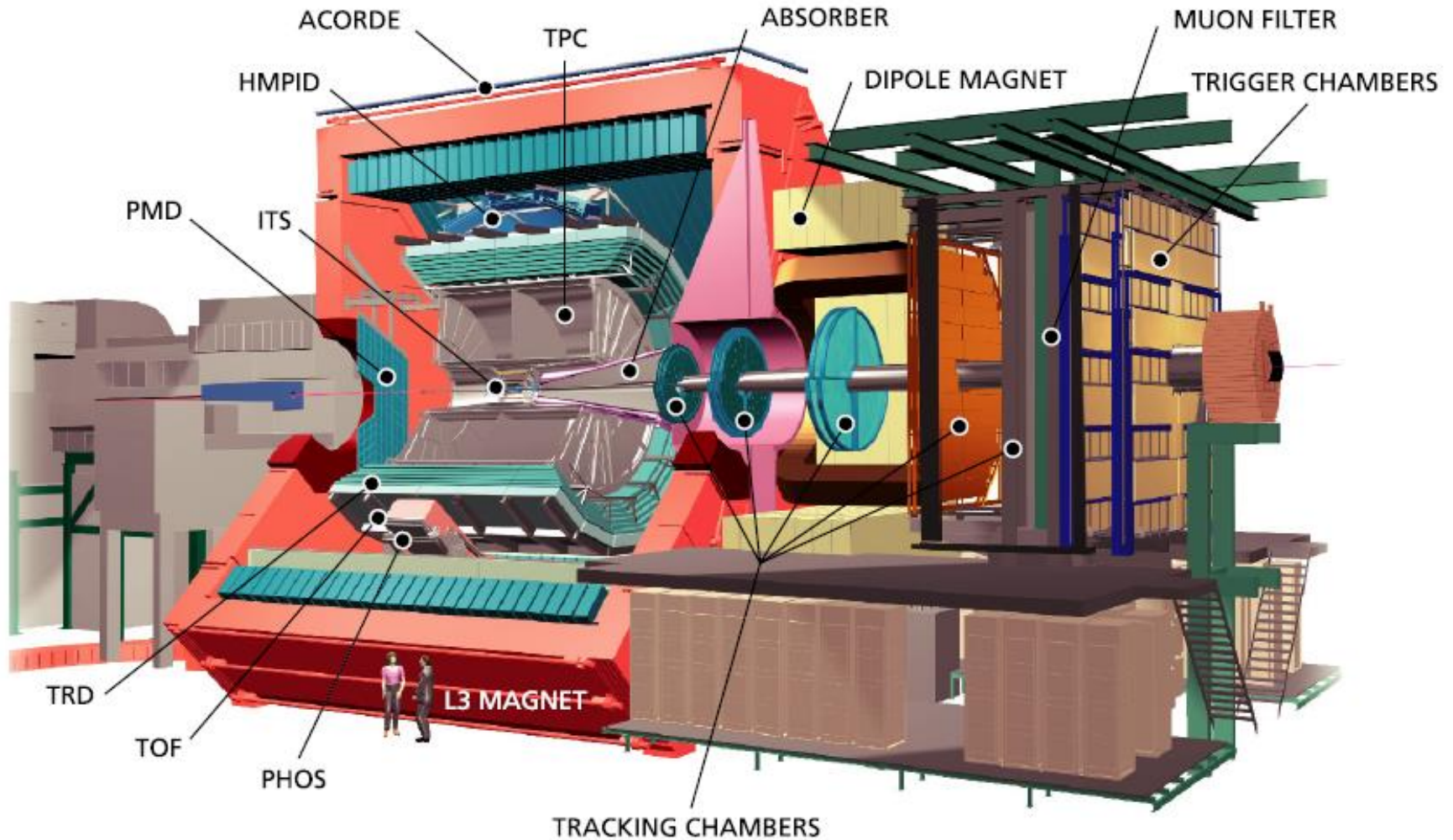



Pierre Auger Cosmic Ray Observatory

Pierre Auger Cosmic Ray Observatory

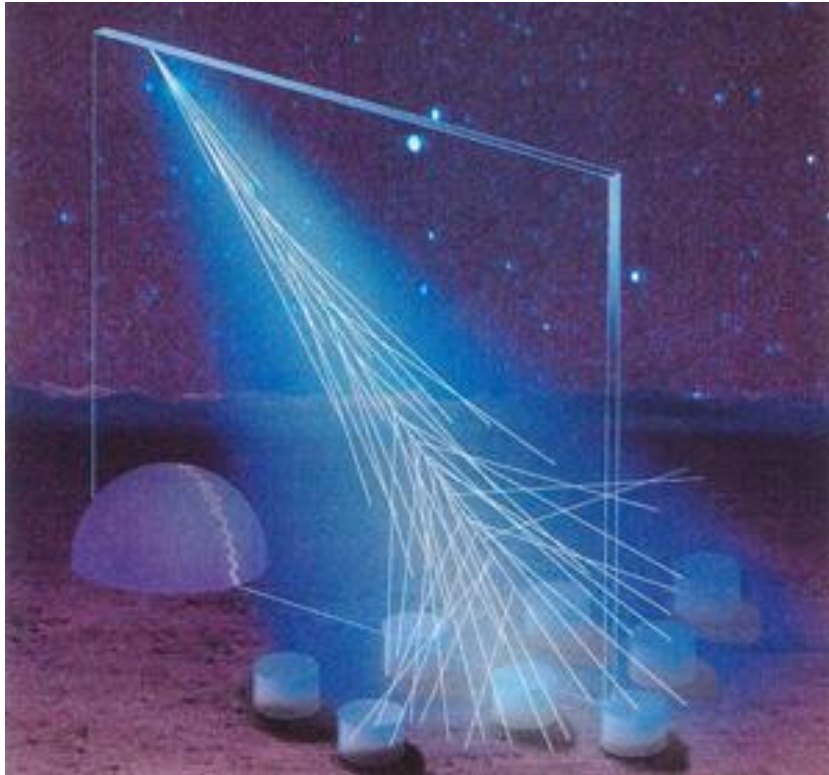

Use earth's atmosphere as a calorimeter. 1600 water Cherenkov detectors with 1.5km distance.

Placed in the Pampa Amarilla in western Argentina.



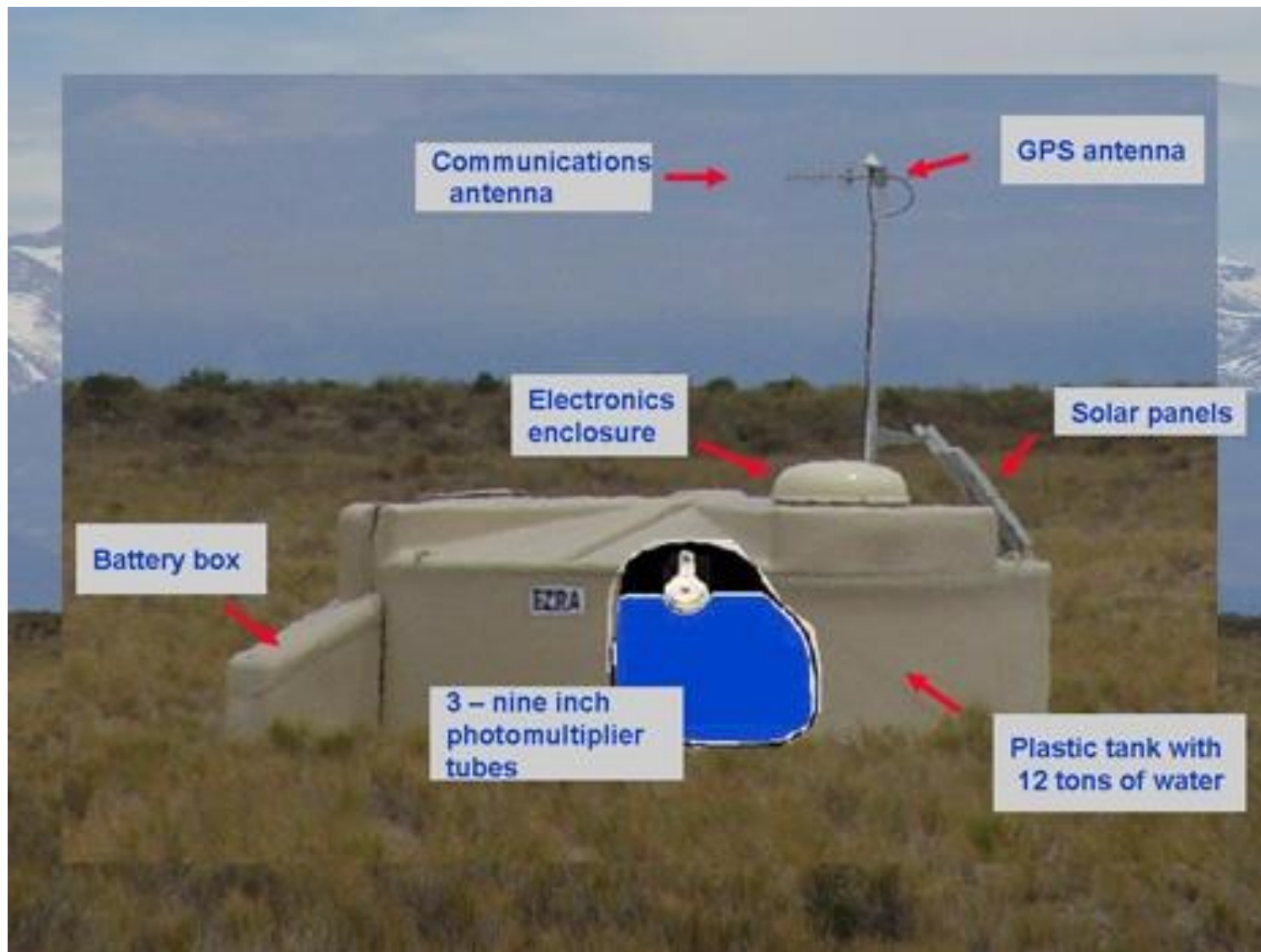

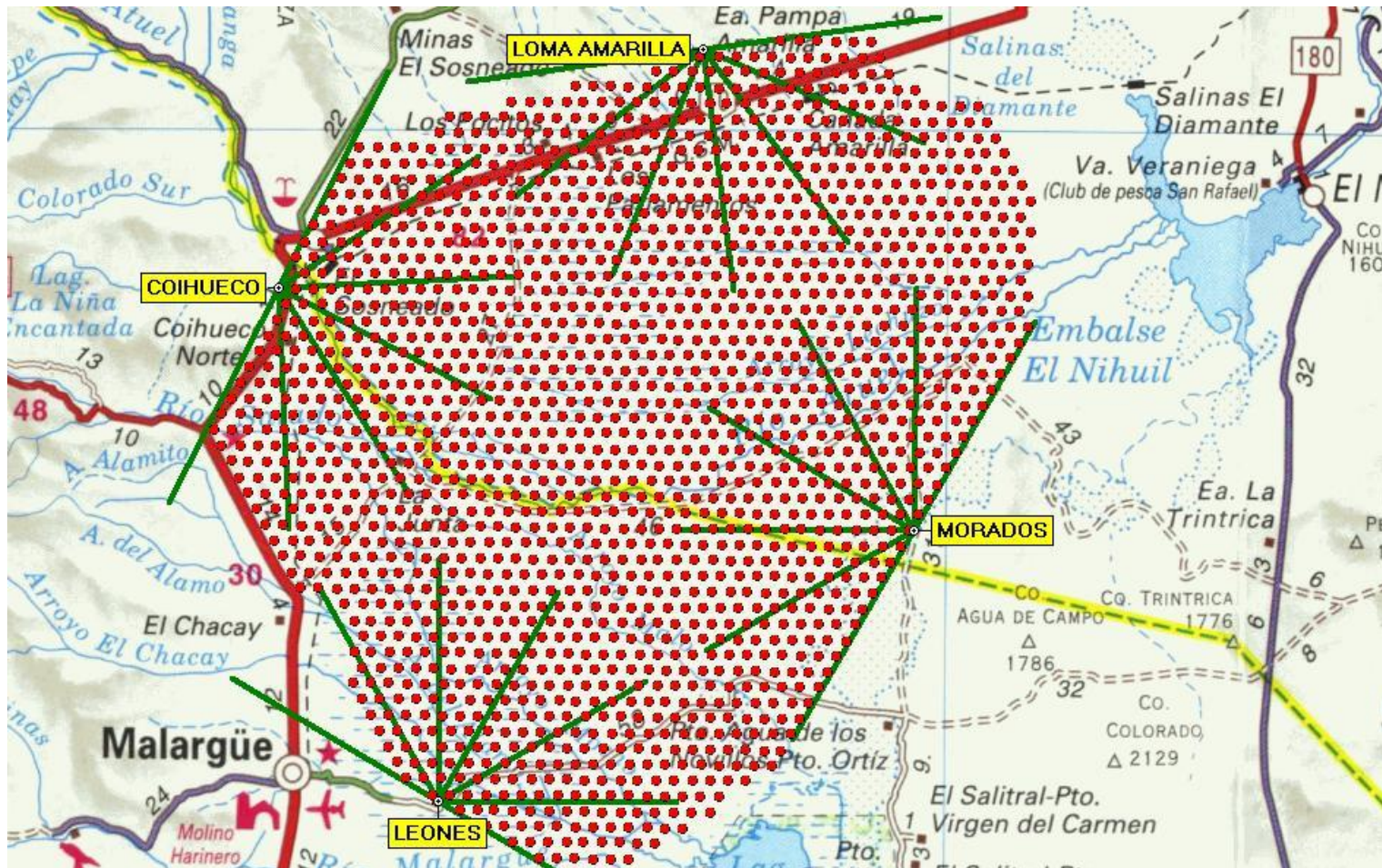

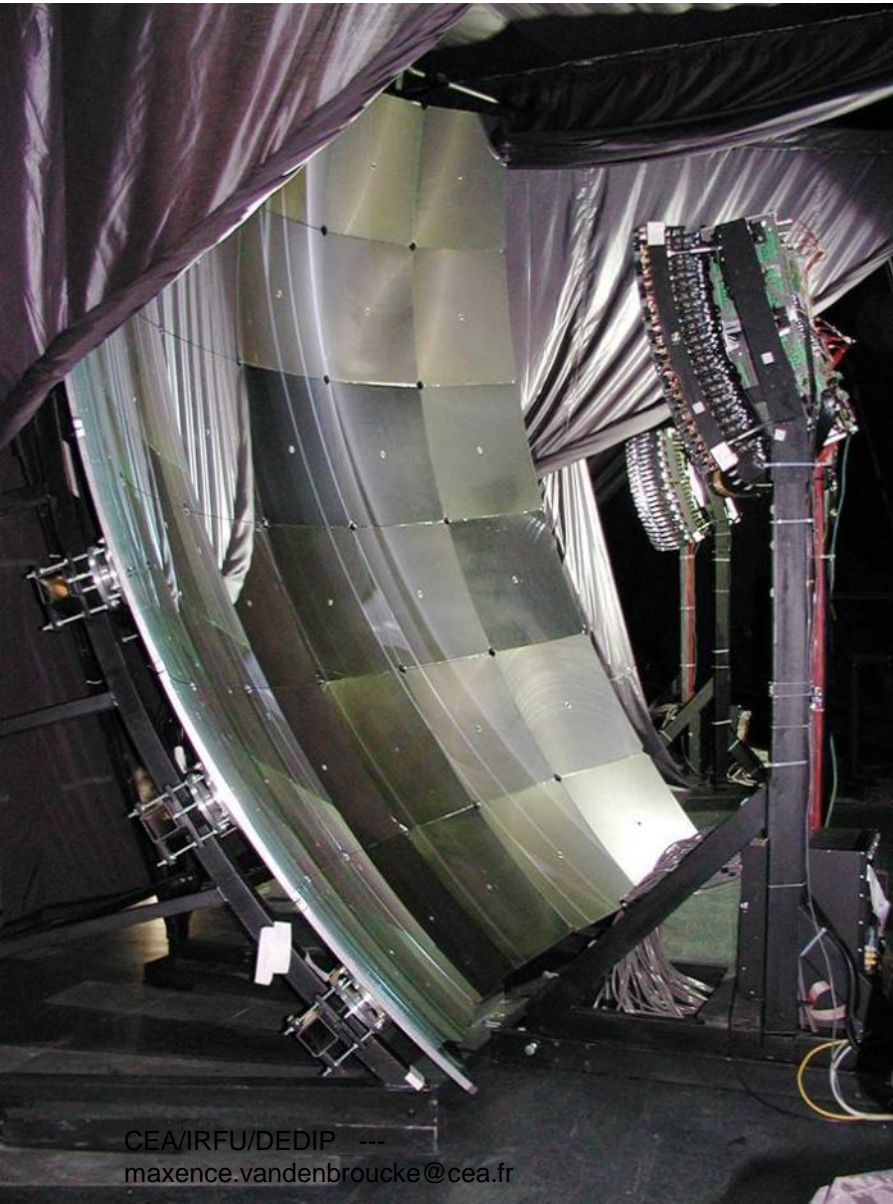

In addition: Fluorescence detectors around the array of water tanks.



Event 1234800

[See CR incoming direction](#) | [See individual station data](#)

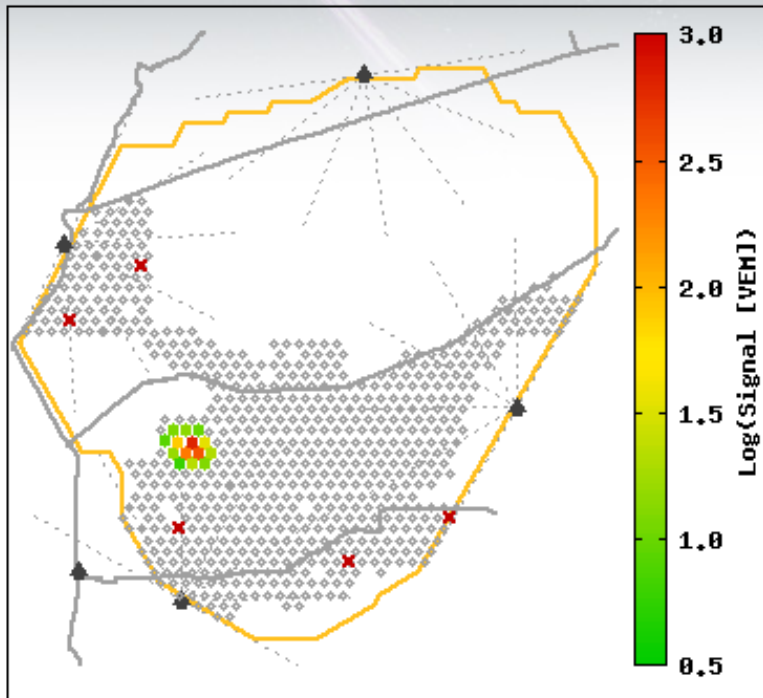

37 EeV = Exa Electron Volt = 37×10^{18} eV

Generic Information	
Id	1234800
Date	Sat Mar 5 15:54:48 2005
Nb Station	14
Energy	37.4 ± 1.2 EeV
Theta	43.4 ± 0.1 deg
Phi	-27.3 ± 0.2 deg
Curvature	15.8 ± 0.8 km
Core Easting	460206 ± 20 m
Core Northing	6089924 ± 11 m
Reduced χ^2	2.30

Event 1234800

[See event reconstruction data](#) | [See CR incoming direction](#)

LsId 159 - Marion

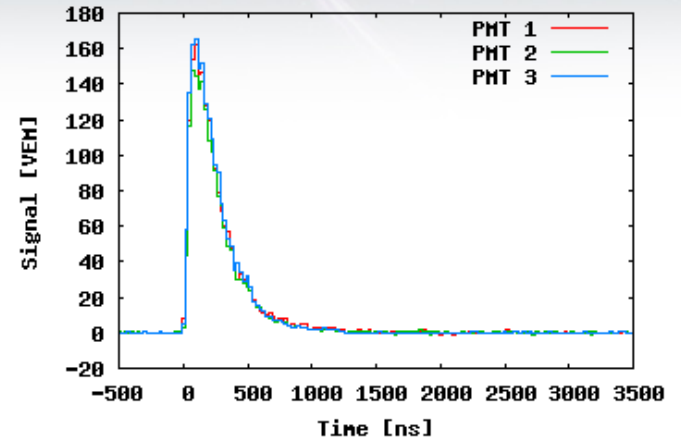

Signal in VEM for the 3 PMTs of station 159 (Marion) as a function of time

LsId 160 - DAD

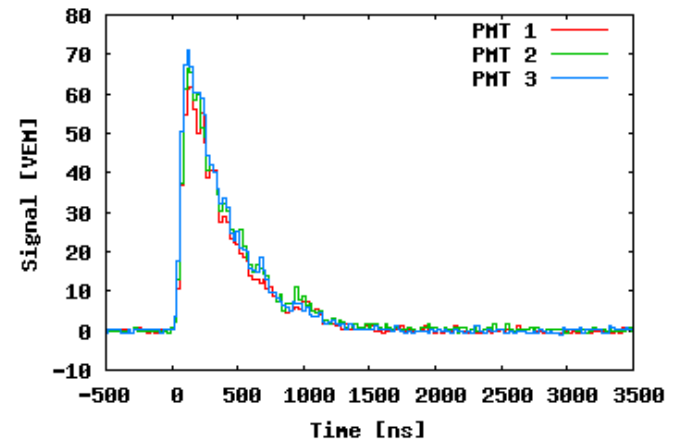

Signal in VEM for the 3 PMTs of station 160 (DAD) as a function of time

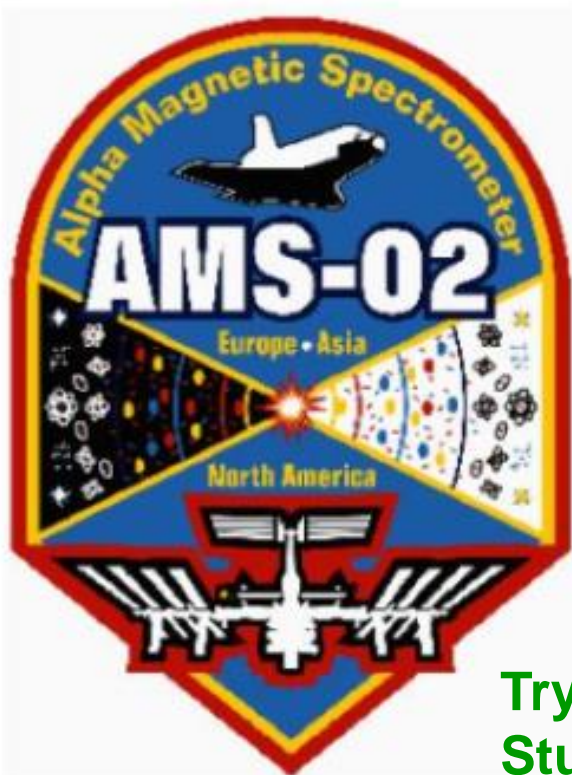

AMS

ALPHA MAGNETIC **S**PECTROMETER

Try to find Antimatter in the primary cosmic rays.
Study cosmic ray composition etc. etc.

Will be installed on the space station.

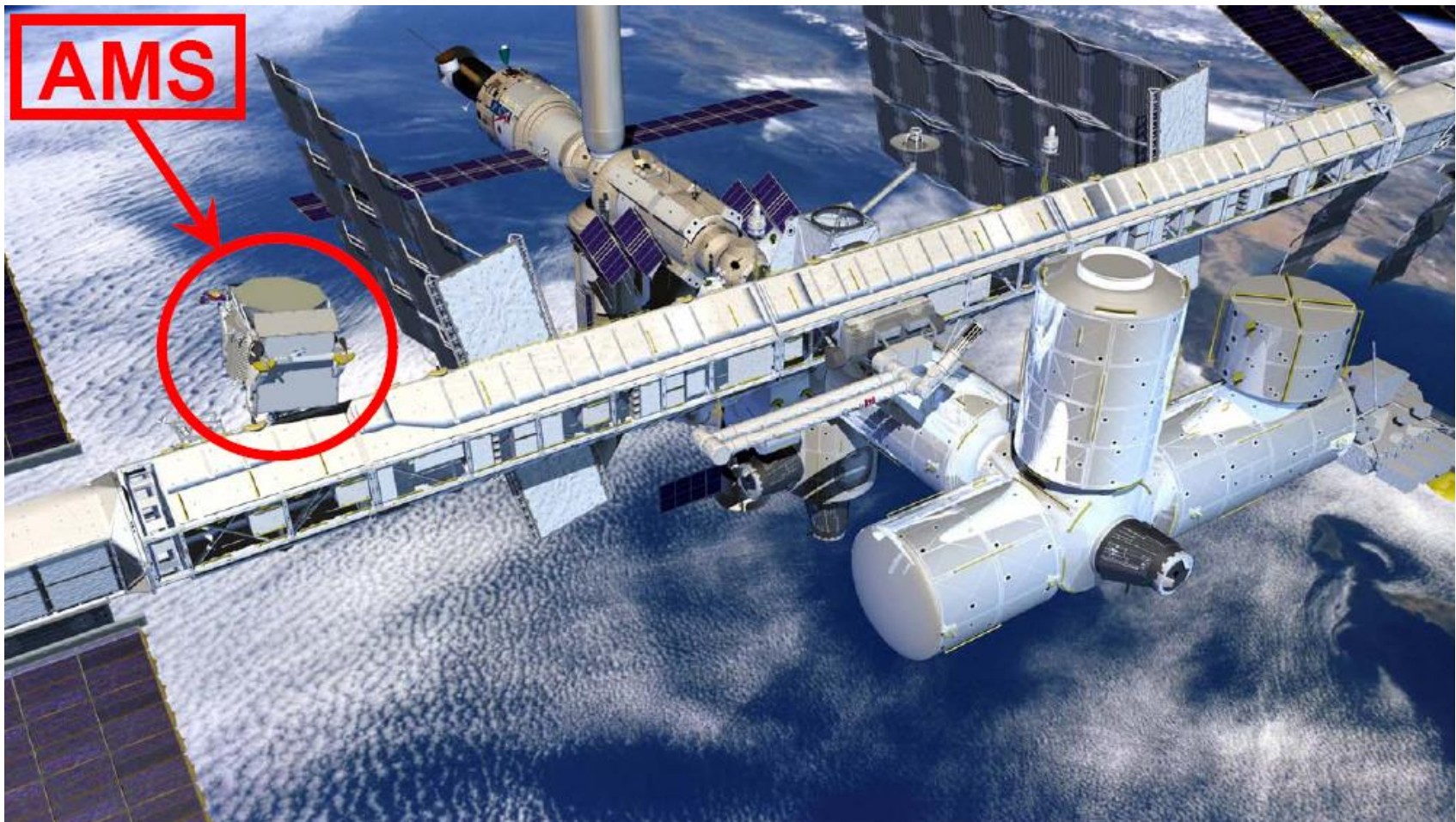

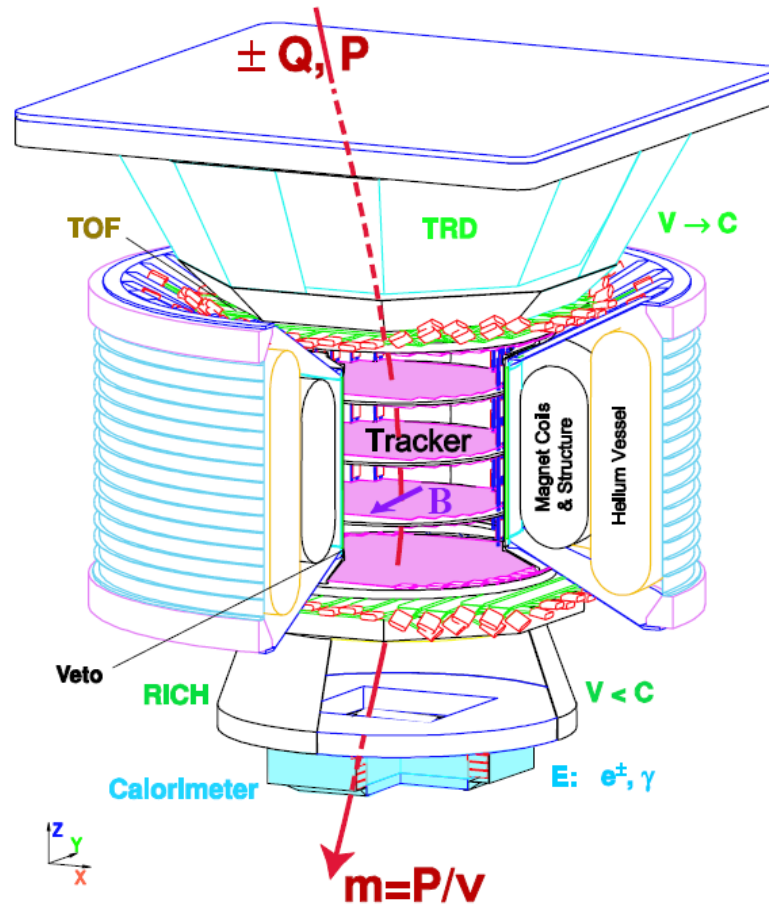

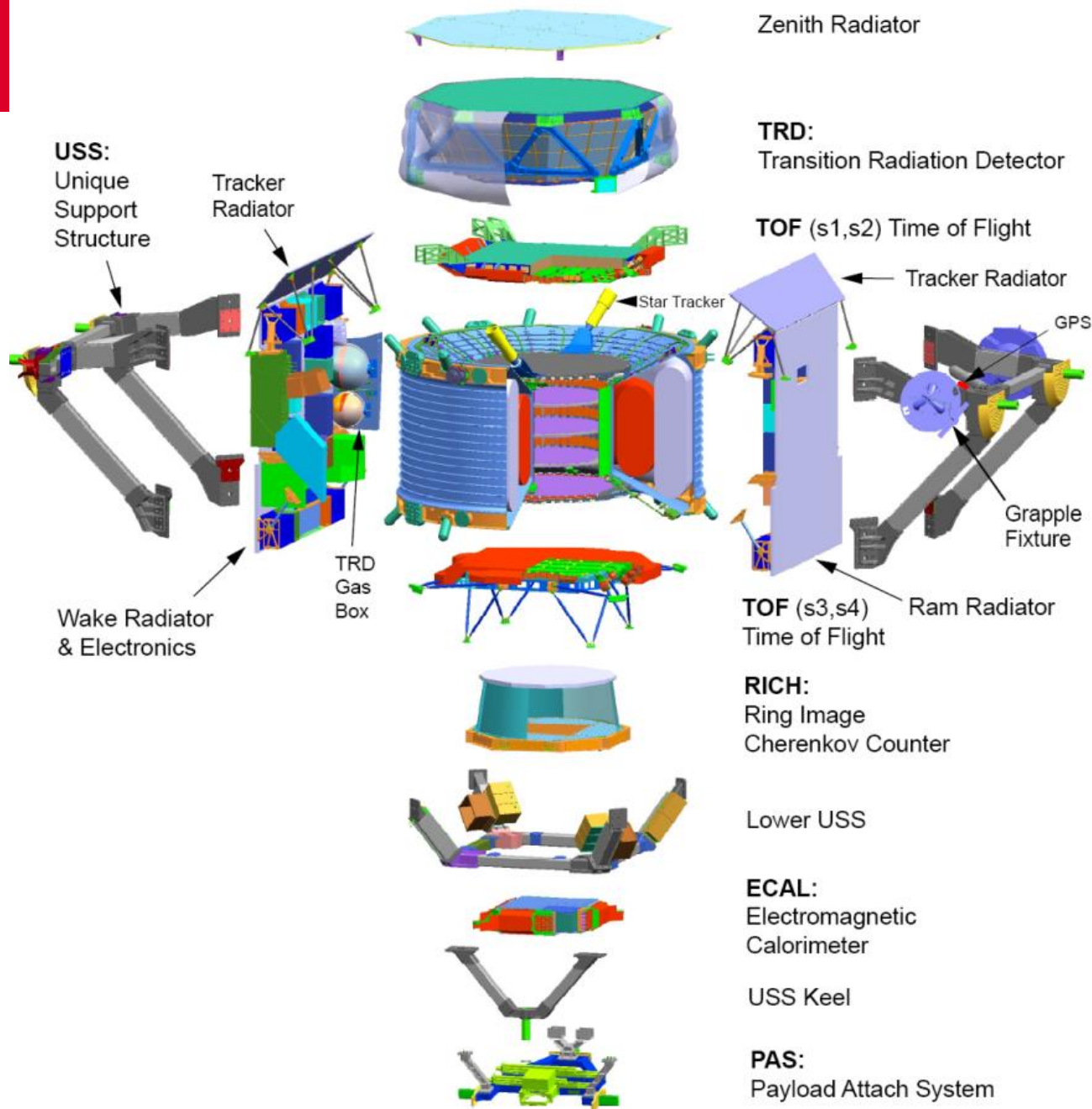



Schematic

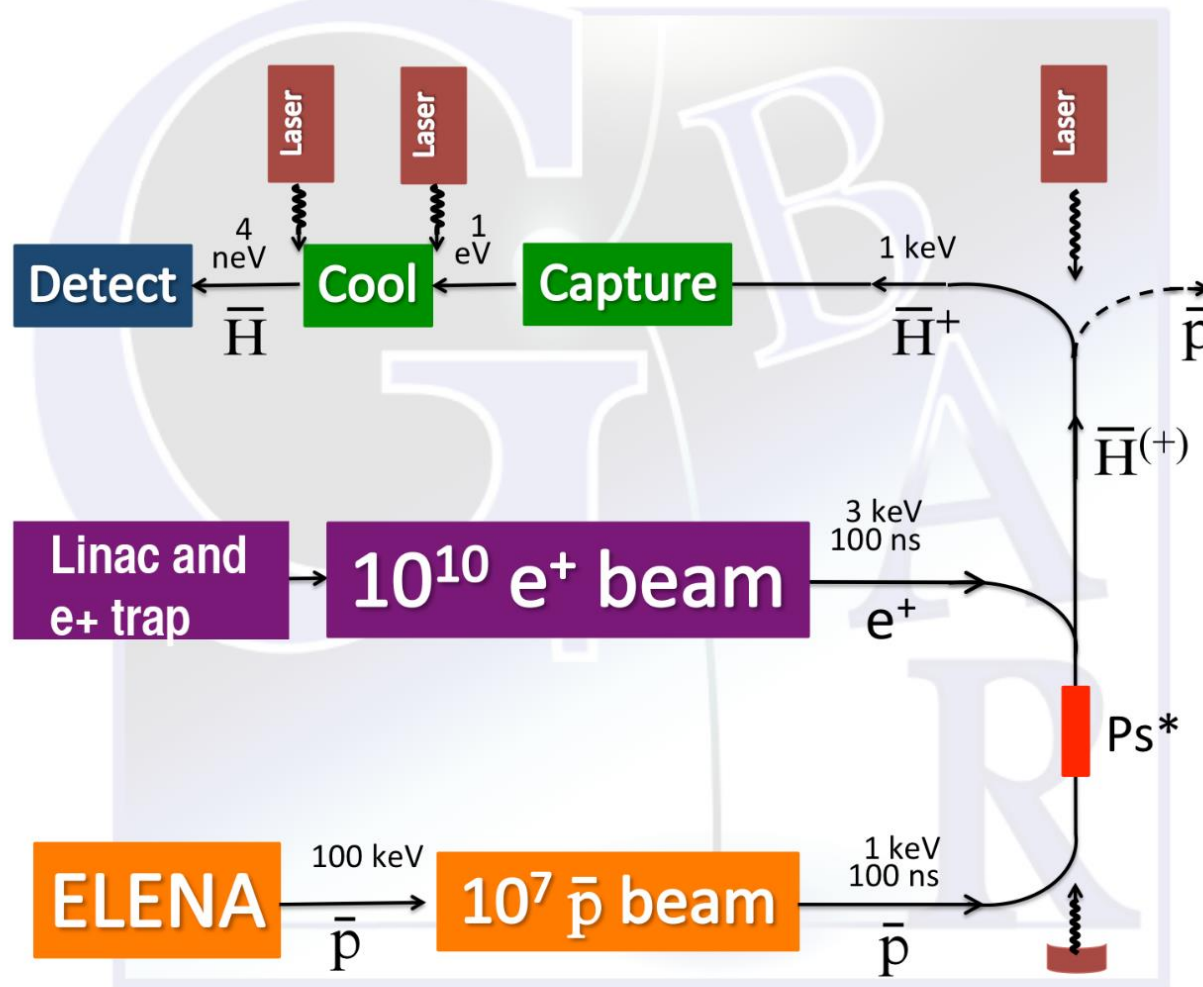

Detection

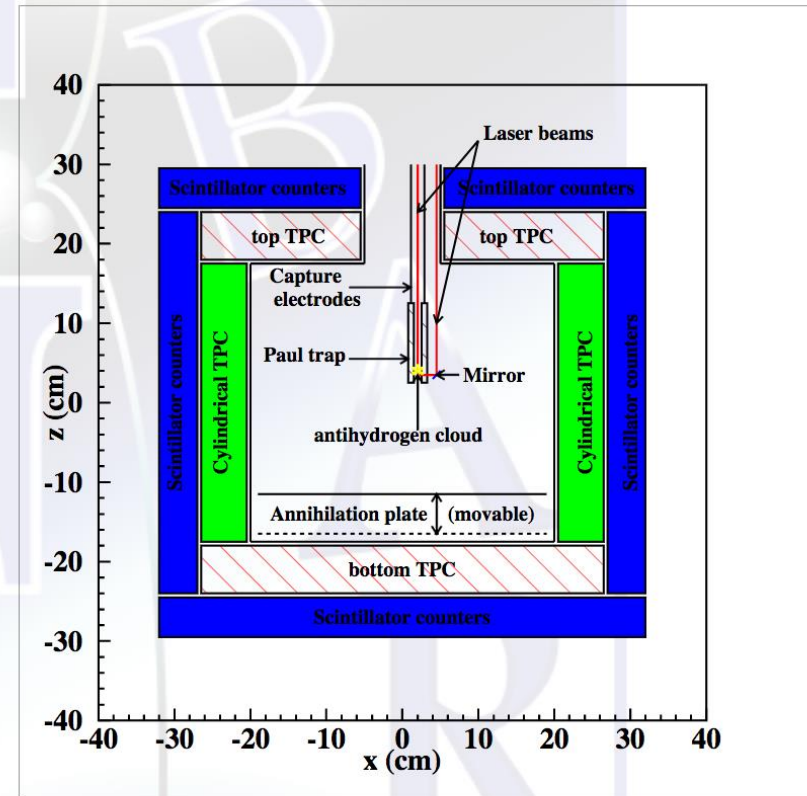
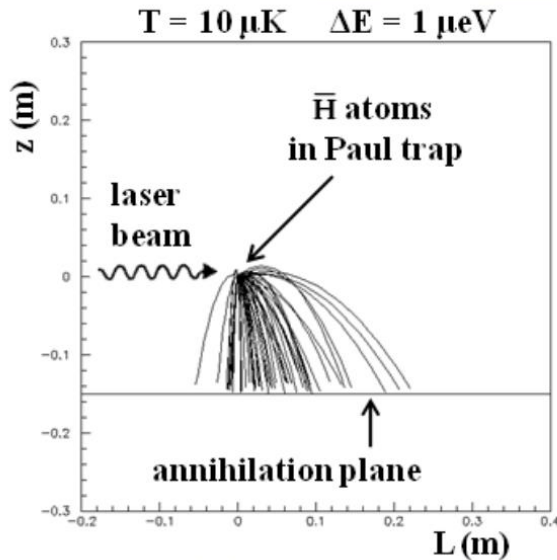

Detection requirement:

TOF precision : $150 \mu\text{s}$

Annihilation vertex precision : 1 mm

Background rejection through event topology

Scheme under design: TPC with micromegas chamber (as in T2K near detector)

$$\frac{\Delta \bar{g}}{\bar{g}} \approx 10^{-2}$$

Cours 1 : Généralités

- Introduction générale sur l'importance de la mesure
- Qu'est-ce qu'une expérience de physique subatomique ?
- Que veut-on observer à propos d'une particule ?
- Architecture générale d'une expérience en physique subatomique

Cours 2 : Les détecteurs de particules

- Trajectographie :
 - Détecteurs Gazeux
 - Détecteurs au Silicium
- Calorimétrie
- Scintillation

Cours 3 : Exemple d'expériences

- Autour du Neutrino
- Nucléaire et Hadronique
- Rayons Cosmiques
- Antimatière

Basé sur les cours de Stefano Panebianco (CEA/IRFU) rencontre d'ete 2016

Le cours de Werner Riegler (CERN Summer Student Lecture Program 2009)

Particle Detectors , Second Edition, C. Grupen & B. Shwartz

DONUT

Detector for Observation of Tau Neutrino.

Creating a Tau Neutrino Beam

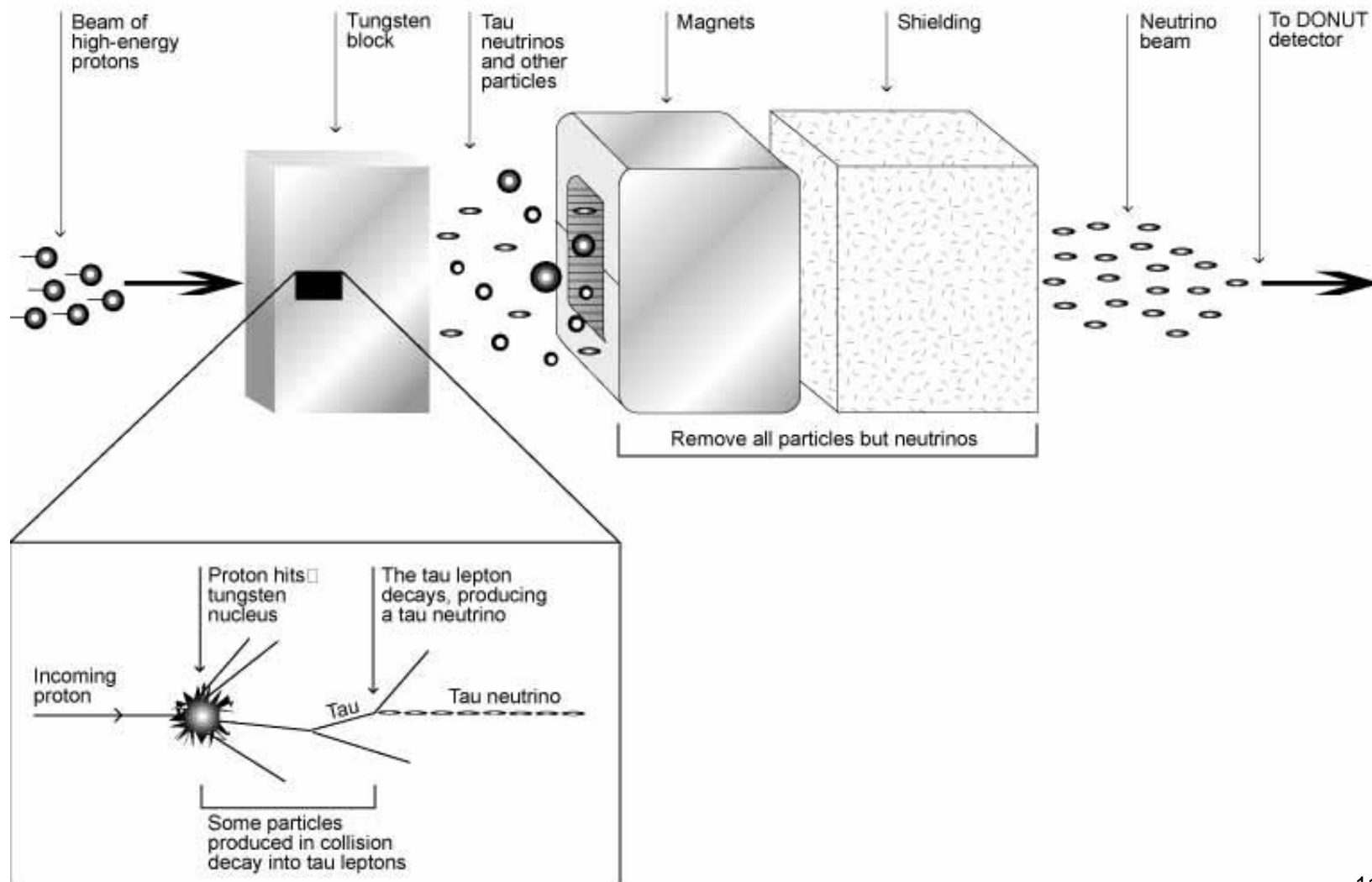

DONUT

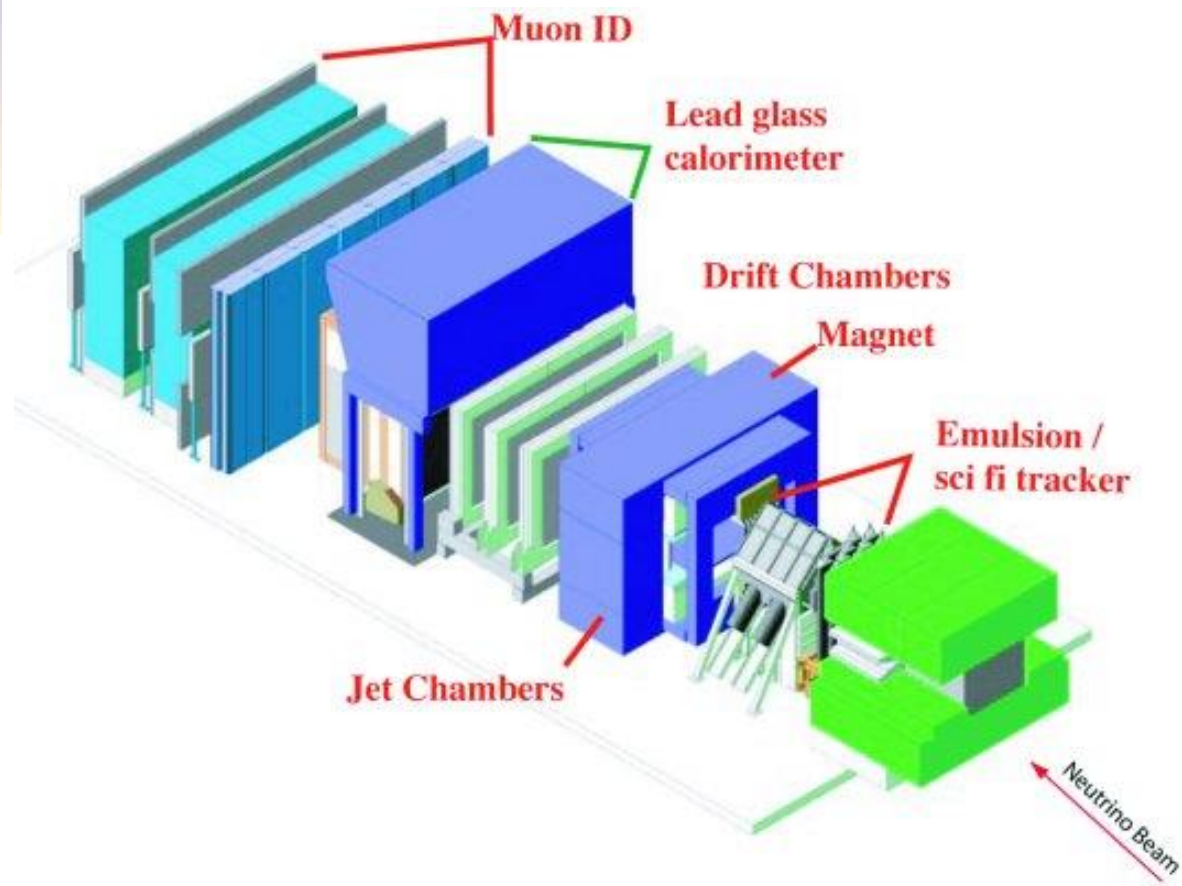
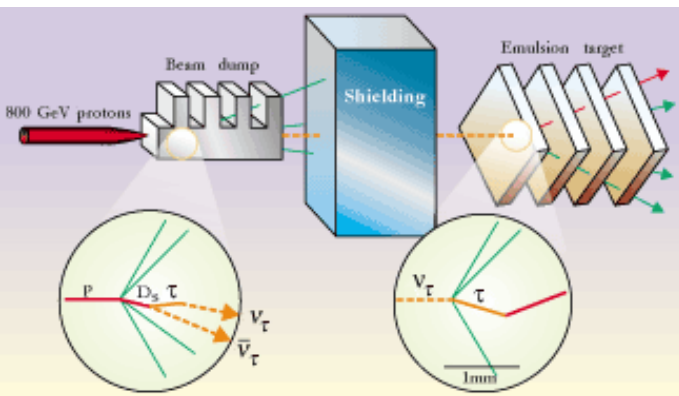

Detecting a Tau Neutrino

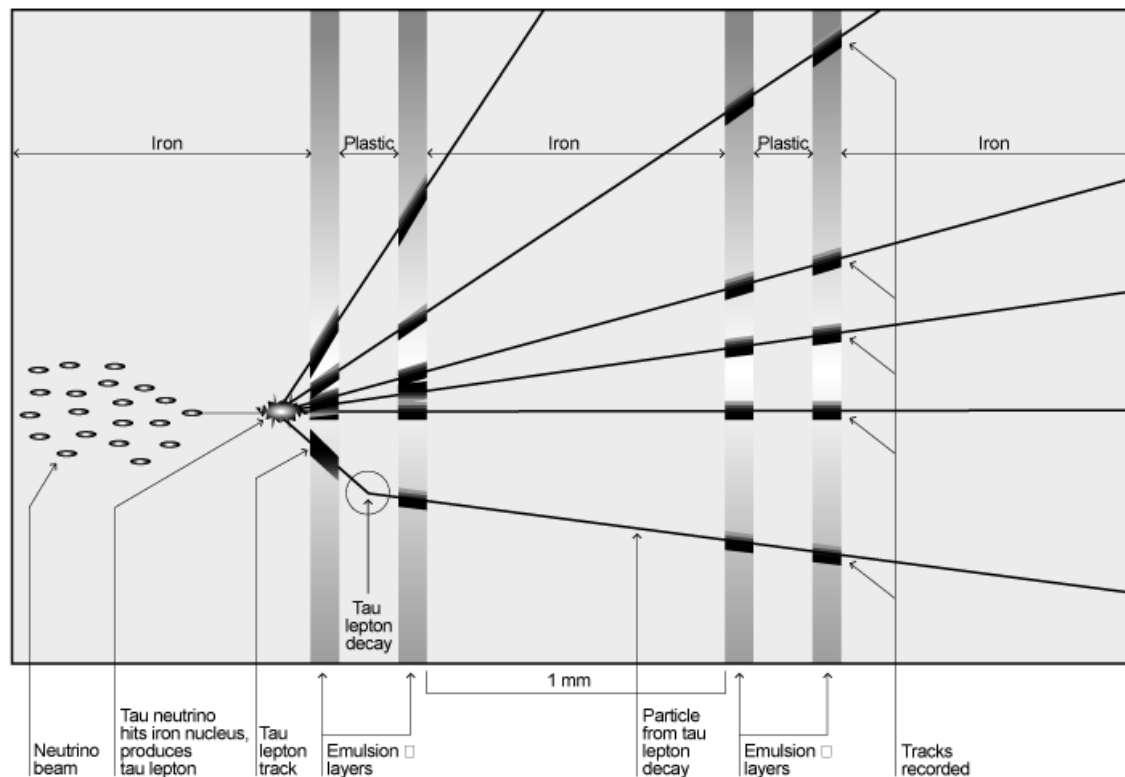

Tau lepton has very short lifetime and is therefore identified by the characteristic 'kink' on the decay point.

Of one million million tau neutrinos crossing the DONUT detector, scientists expect about one to interact with an iron nucleus.

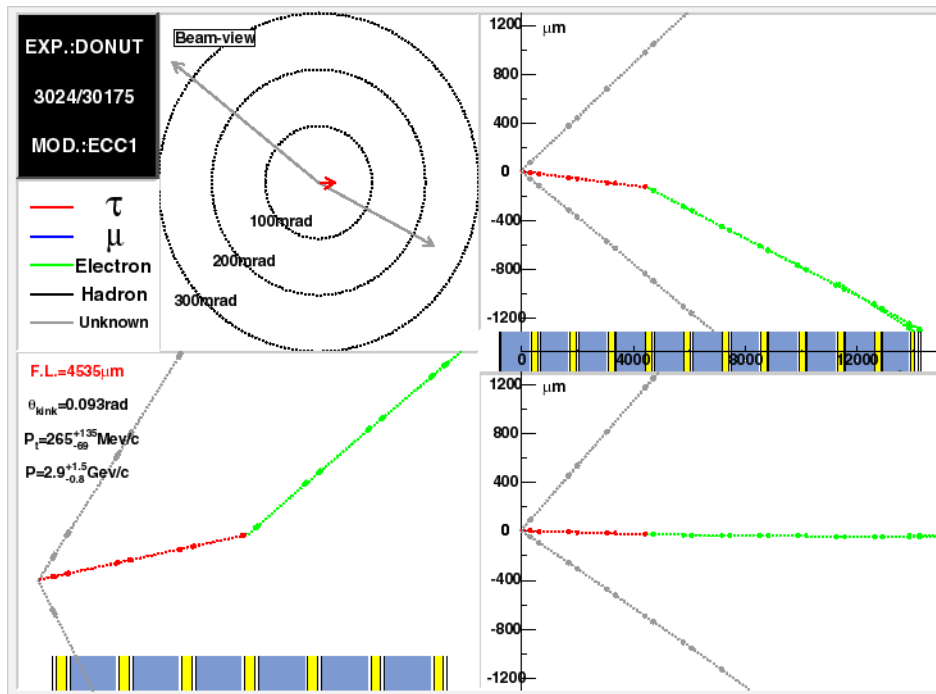

One of the 4 tau candidates.

Emulsion resolution 0.5 μ m !

ELSEVIER

Section A

MICROMEGAS: a high-granularity position-sensitive gaseous detector for high particle-flux environments

Y. Giomataris^{a,*}, Ph. Rebourgeard^a, J.P. Robert^a, G. Charpak^b

^aCEA/DSM/DAPNIA/SED-C.E.-Saclay, 91191 Gif/Yvette, France

^bEcole Supérieure de Physique et Chimie Industrielle de la ville de Paris, ESPECI, Paris, ESPCI, Paris, France and CERN/AT, Geneva, Switzerland

Abstract

We describe a novel structure for a gaseous detector that is under development at Saclay. It consists of a two-stage parallel-plate avalanche chamber of small amplification gap (100 μm) combined with a conversion-drift space. It follows a fast removal of positive ions produced during the avalanche development. Fast signals (≤ 1 ns) are obtained during the collection of the electron avalanche on the anode microstrip plane. The positive ion signal has a duration of 100 ns. The fast evacuation of positive ions combined with the high granularity of the detector provide a high rate capability. Gas gains of up to 10^5 have been achieved.

1. Introduction

Multiwire proportional chambers have been originally designed for high-rate applications [1]. Their flux capability was mainly limited by the positive-ion space charge created because of the low ion drift velocity with a typical drift time of several tenths of microseconds. Their spatial resolution was limited by the wire spacing, which was of the order of 1 mm.

To overcome these limitations, a new technique, the microstrip gas chamber (MSGC), has been developed over the last eight years [2–4]. Wires are replaced by strips printed on an insulating support; a high electric field region, sufficient for electron multiplication, is created between the thin cathode and anode conductive strips. It is new class of gas detector relying on the microelectronics technology. The small inter-strip pitch allows a good spatial resolution, inferior to 100 μm and the fast collection of the charges offers the possibility to cope with higher counting rates. One limitation of the MSGC detector is the fact that the avalanche multiplication does not exceed 10^5 , because of breakdown on the insulator surface. Positive ions created during the avalanche process and

the detector [5]. A lot of effort has been invested, during the last few years, resolve the charging-up problems by a careful choice of the resistivity of the substrate or a special treatment of its surface. Another type in this class of gas detectors, the micro-gap chamber [6], was recently developed aiming to resolve the charging-up problem and giving superior results in terms of rate capability and spatial resolution.

Another possible way out is the use of a special asymmetric configuration of the multiwire structure [7,8] with alternating anodes and field-shaping wires, mounted close to the cathode plane with engraved pick-up strips orthogonal to the wire direction. The performance of this structure equals that of the MSGC in terms of rate capability and spatial resolution. In addition it can achieve higher electron multiplication factors and it operates in a stable fashion for long irradiation periods. The drawback here is the use of delicate wires and the wire stretching force, which is proportional to the total number of wires acting in the wire frame; this therefore has to be of substantial thickness.

In this paper we present a new approach where the wire plane is replaced by a thin electroformed micromesh. The



Voltaire Micromégas

Texte intégral
+ dossier par Guillaume Peureux



folioplus
classiques

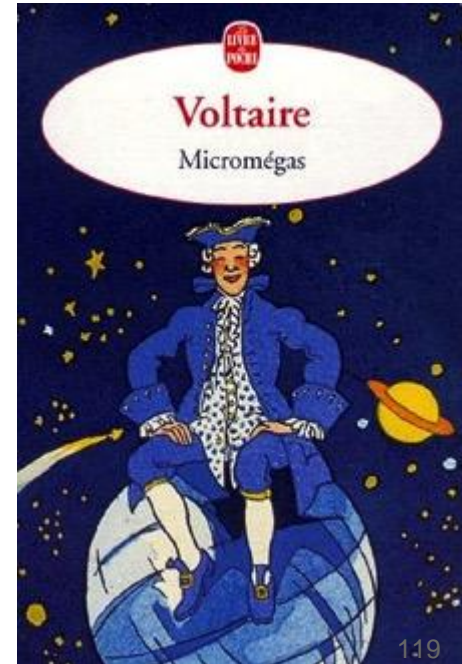

avalanche chamber and it is called MICROMEGAS (MICRO-MESH-Gaseous Structure).

- Haut gain ($>10^4$)
- Bonne résolution en énergie (11% à 6keV)
- Bonne résolution temporelle ($<1\text{ns}$)
- Tenue à haut flux
- Bonne résolution spatiale ($<50\ \mu\text{m}$)
- Remontée ionique réduite $<1\%$
- Résistance aux radiations ($10^{16}\ \text{p/cm}^2$)

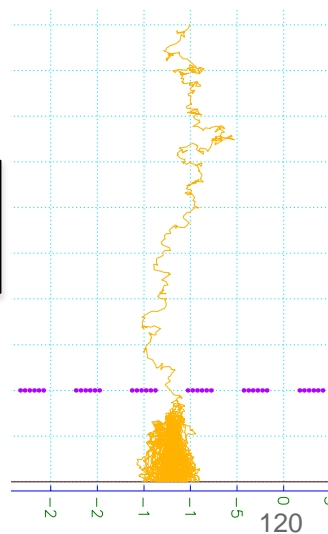
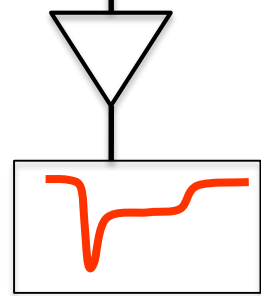
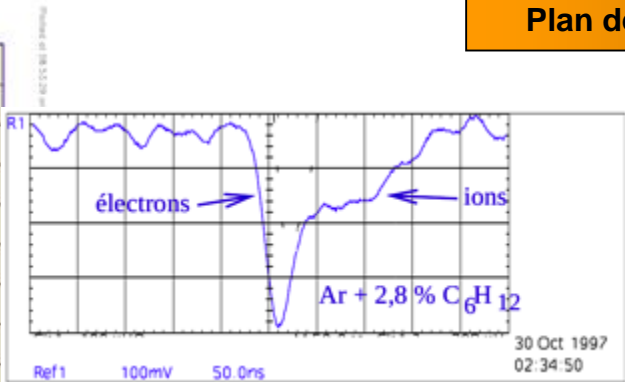
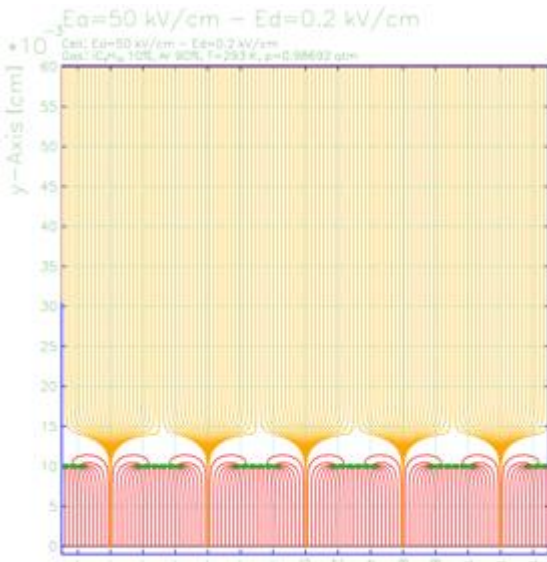
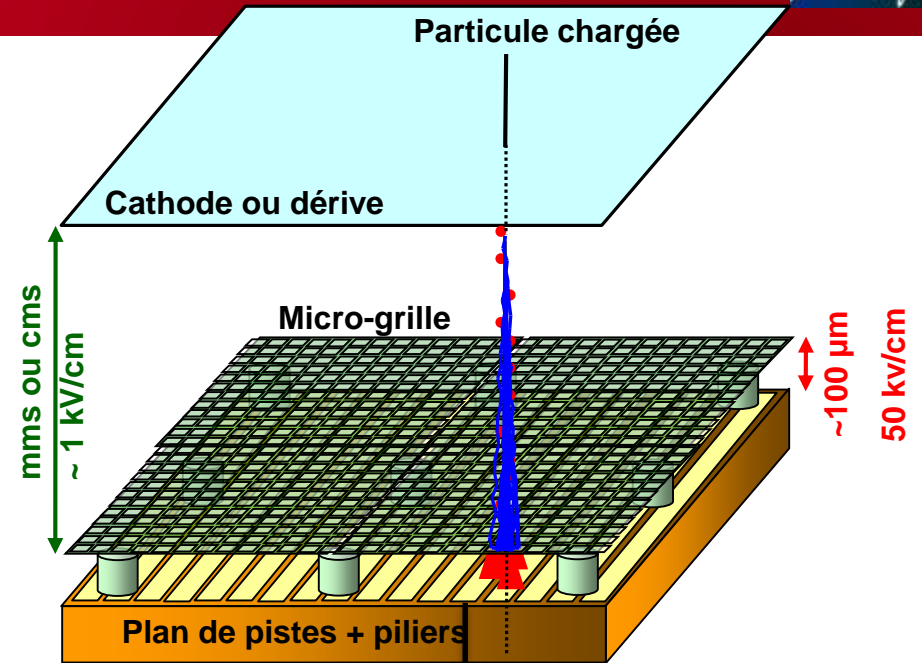

Collection rapide des ions → fonctionnement à haut flux

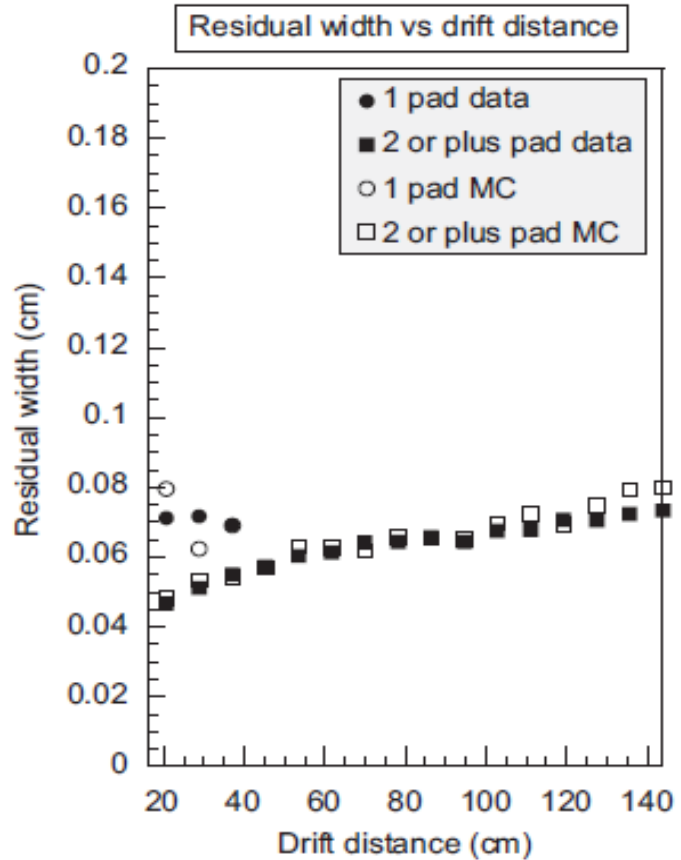

Tenue à haut flux et vieillissement

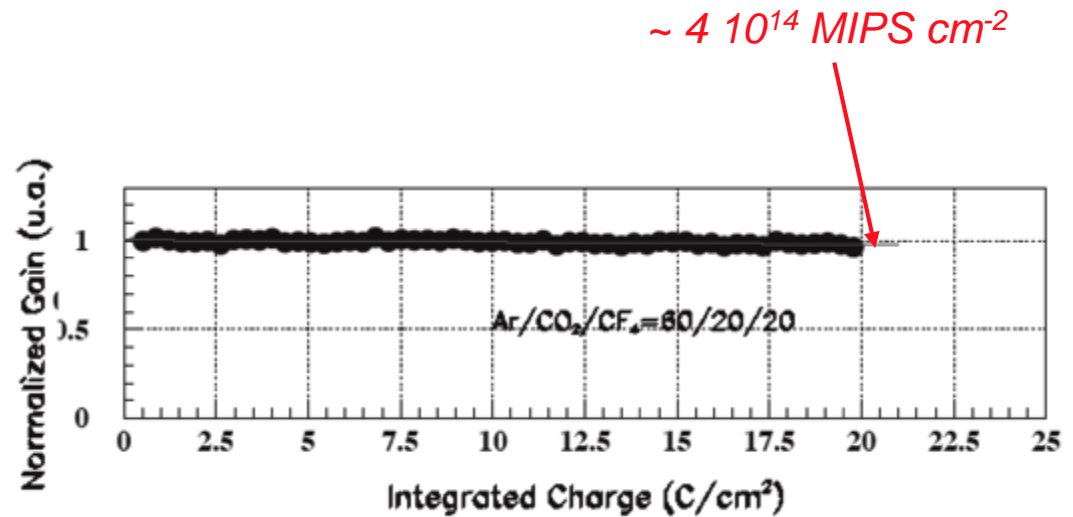

Résolution spatiale dans une TPC
(Chambre à projection temporelle)

PREMIERS PROTOTYPES EN 2004. COLLABORATION CERN/IRFU

LA MICRO-GRILLE TISSÉE EST LAMINÉE ENTRE 2 COUCHES PHOTO-IMAGEABLES

MÉCANIQUE RÉDUITE → DIMINUTION DES ZONES MORTES

GRANDES SURFACES

ROBUSTE, PROCÉDÉ INDUSTRIEL (CIRCUIT IMPRIMÉ)

Atelier BULK du SEDI



Lamination

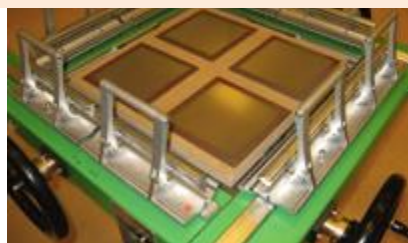

Intégration de la micro-grille



Insolation



Développement

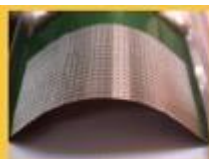

Bulk flexible sur Kapton de 50 microns



Détail: mesh prise entre deux plots

CEA/IRFU/DEDIP ---
maxence.vandenbroucke@cea.fr

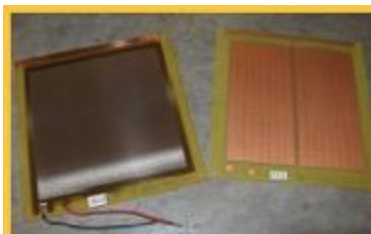

Bulk et PCB nu 120 x 140 mm



Plots de 400 microns au pas de 2 mm. Mesh inox 500 LPI



PCB nu équipé avec ses pistes ou pixel

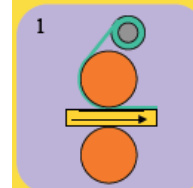

Lamination

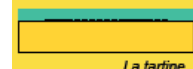

PCB avec une couche de photoresist

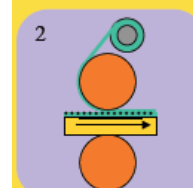

Lamination

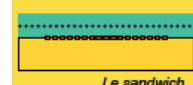

PCB avec la micro-grille entre deux couches de photoresist

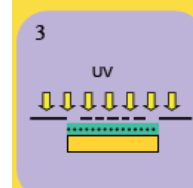

Insolation



Une partie du photoresist est insolée



La pizza

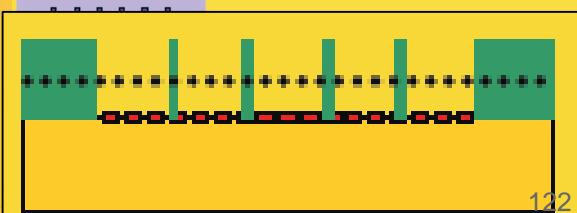

Le bulk !!!

du PCB.

Historique des détecteurs gazeux



MWPC

Multi-Wire Proportional Chamber

C. Charpak et al., 1968



TPC

Time Projection Chamber
D. R. Nygren et al., 1974

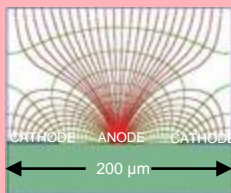

MSGC

Micro-Strip Gas Chamber

A. Oed, 1988



Micro Pattern Gaseous Detectors: MPGD

GEM
Gas Electron Multiplier
F. Sauli, 1997



MICROMEAS
MICRO-MEsh Gaseous Structure
I. Giomataris et al., 1996

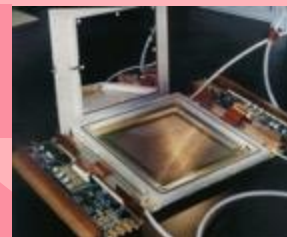

CLASSICAL
1996

BULK
2003

INGRID
2005

MICROBULK
2006

RESISTIVE ANODE
2005-2013

CLASSICAL
1996

BULK
2003

INGRID
2005

MICROBULK
2006

Mesh
Readout
plane

TWO mechanical
entities

INTEGRATED:
ONE single entity

Type of
mesh

Any
type

30 μm
Stainless steel

1 μm
Aluminium

5 μm
Copper

Advantages

Demontability
Large Surface

Robust
Industrial
manufacturing
process (PCB)

Excellent energy
resolution
Single electron
efficiency

Intrinsically
Flexible
Low mass
Radiopure

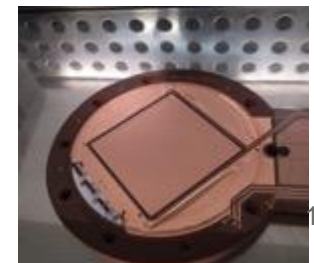
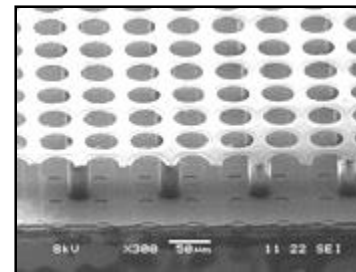
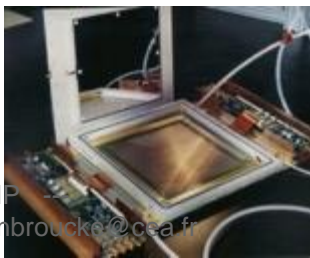

At the p-n junction the charges are depleted and a zone free of charge carriers is established.

By applying a voltage, the depletion zone can be extended to the entire diode → highly insulating layer.

An ionizing particle produces free charge carriers in the diode, which drift in the electric field and induce an electrical signal on the metal electrodes.

As silicon is the most commonly used material in the electronics industry, it has one big advantage with respect to other materials, namely highly developed technology.

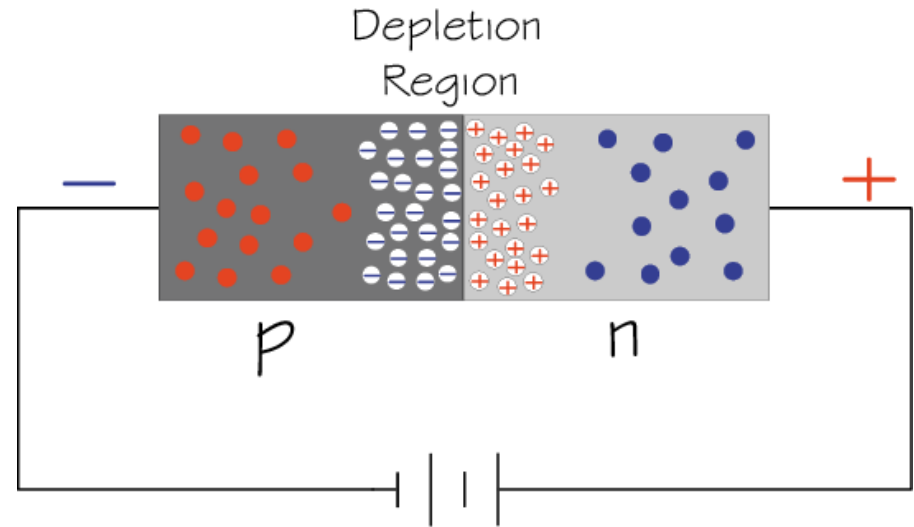

- Electron
- ⊕ Positive ion from removal of electron in n-type impurity
- ⊖ Negative ion from filling in p-type vacancy
- Hole

Doping of Silicon

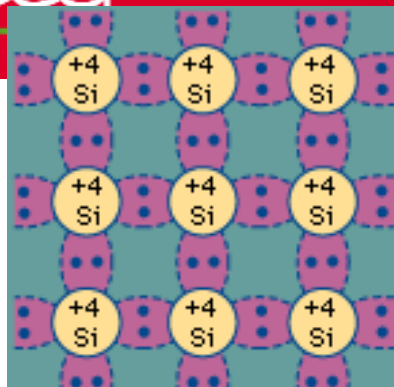

doping

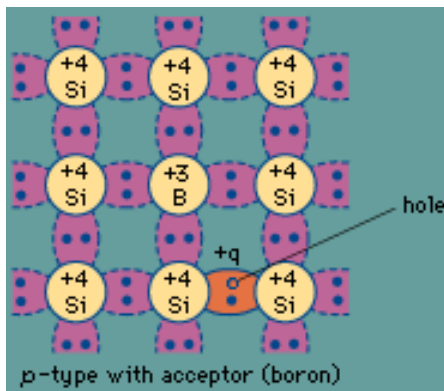
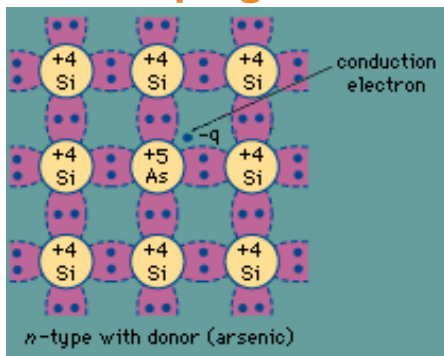

In a silicon crystal at a given temperature the number of electrons in the conduction band is equal to the number of holes in the valence band.

Doping Silicon with Arsen (+5) it becomes and n-type conductor (more electrons than holes).

Doping Silicon with Boron (+3) it becomes a p-type conductor (more holes than electrons).

Bringing p and n in contact makes a diode.

