

# Les Noyaux et leurs Interactions

A. Lopez-Martens

CSNSM, IN2P3/CNRS, Université Paris Sud

# Objectifs

- un peu de connaissances...
- un peu d'histoire...
- les dernières nouvelles en la matière....

# Plan

- Introduction & Radioactivité - *De la Radioactivité au Noyau*
- Echelles Nucléaires - *Du Noyau jusqu'au Neutron et les Accélérateurs*
- Intéraction Nucléaire - *D'avant 2ème guerre mondiale jusqu'à nos jours*

# Quelques bons outils

- National Nuclear Data Center (NNDC)

<http://www.nndc.bnl.gov>

**National Nuclear Data Center**  
BROOKHAVEN NATIONAL LABORATORY Site Index -  Go

**ND2013 Proceedings**  
**Nuclear Data Sheets**  
First Volume (118) for ND2013 is available!  
We moved! Click on this text for map.  
EXFOR 20,000 Milestone  
Atomic Mass Evaluations Available

**Main** | Structure & Decay | Reactions | Bibliography | Networks & Links | Publications | Meetings

<b>AMDC</b> Atomic Mass Data Center, <i>Q-value Calculator</i>	<b>Atlas of Neutron Resonances</b> Parameters & thermal values	<b>CapGam</b> Thermal Neutron Capture $\gamma$ -rays	<b>Chart of Nuclides</b> Basic properties of atomic nuclei
<b>Covariances</b> of Neutron Reactions	<b>CSEWG</b> Cross Section Evaluation Working Group	<b>CSISRS alias EXFOR</b> Nuclear reaction experimental data	<b>Empire</b> Nuclear reaction model code system, <i>Reference paper</i>
<b>ENDF</b> Evaluated Nuclear (reaction) Data File, <i>Sigma</i>	<b>ENSDF</b> Evaluated Nuclear Structure Data File	<b>IRDF</b> International Reactor Dosimetry File	<b>MIRD</b> Medical Internal Radiation Dose
<b>NMMSS &amp; DoE NMIRDC</b> Safeguards & inventory decay data standards	<b>NSR</b> Nuclear Science References	<b>Nuclear Data Sheets</b> Nuclear structure & decay data journal, <i>Special Issues on reaction data</i>	<b>Nuclear Wallet Cards</b> Ground & isomeric states properties, <i>Homeland Security version</i>
<b>NucRates</b> MACS & Astro-physical reaction rates	<b>NuDat</b> Nuclear structure & decay Data	<b>USNDP</b> U.S. Nuclear Data Program	<b>USNDP/CSEWG GForge</b> Collaboration Server
<b>XUNDL</b> Experimental Un-evaluated Nuclear Data List			

# Quelques Bonnes Applications

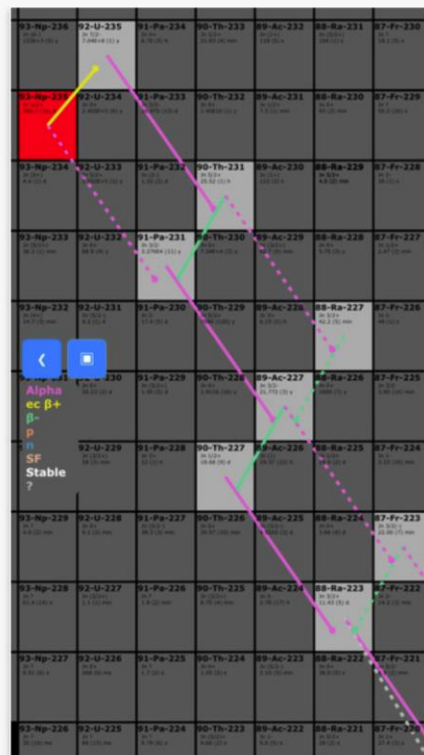
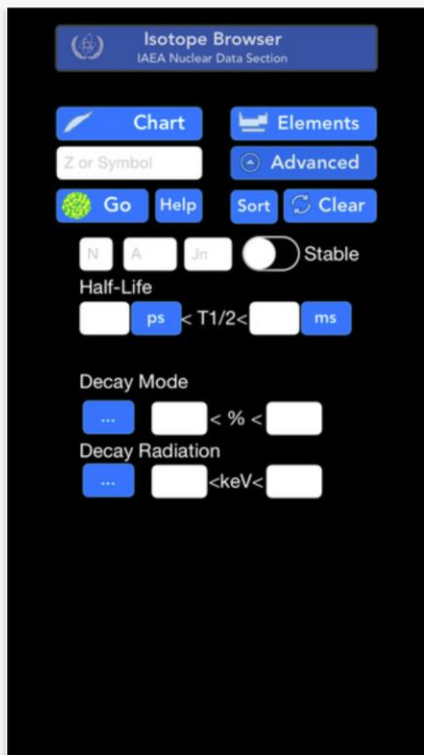
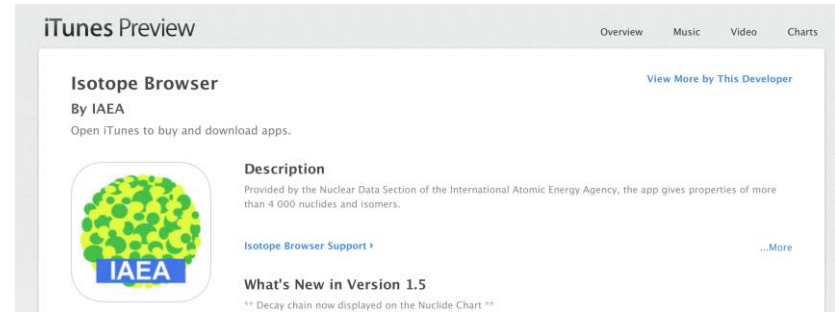
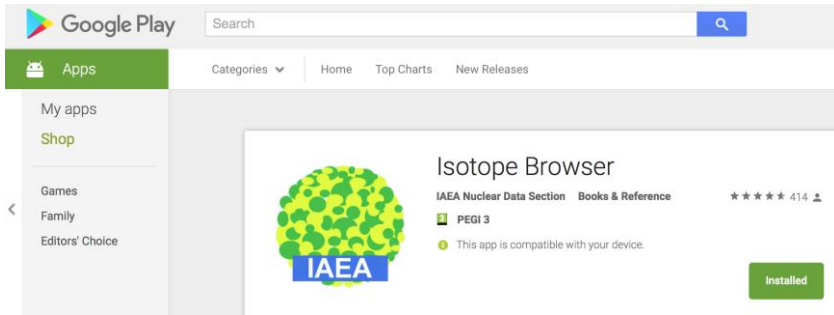

48 Nuclides found with: element = 54 order by Z, N			
<sup>99</sup> Xe <sub>55</sub>	13 (2) ms	(7/2+)	α 100%
<sup>100</sup> Xe <sub>54</sub>	93 (3) ms	0+	α 64 35%
<sup>111</sup> Xe <sub>57</sub>	0.74 (20) s		α 8 +8-5%
<sup>112</sup> Xe <sub>58</sub>	2.7 (8) s		α 0.0080%
<sup>113</sup> Xe <sub>59</sub>	2.74 (8) s	(5/2+)	α = 0.011%
<sup>114</sup> Xe <sub>60</sub>	10.0 (4) s	0+	εc β+ 100%
<sup>115</sup> Xe <sub>61</sub>	18 (4) s	(5/2+)	α 0.0003 1%
<sup>116</sup> Xe <sub>62</sub>	59 (2) s	0+	εc β+ 100%
<sup>117</sup> Xe <sub>63</sub>	61 (2) s	5/2(+)	εc β+ 100%
<sup>118</sup> Xe <sub>64</sub>	3.8 (9) min	0+	εc β+ 100%
<sup>119</sup> Xe <sub>65</sub>	5.8 (3) min	(5/2+)	εc β+ 100%
<sup>120</sup> Xe <sub>66</sub>	40 (1) min	0+	εc β+ 100%
<sup>121</sup> Xe <sub>67</sub>	40.1 (20) min	5/2(+)	εc β+ 100%

**54-Xe-135 Xenon**  
 Uncertainty applies to the least significant digit(s)  
 Z 54 N 81 Jπ 3/2+  
 Half-life 9.14 (2) h  
 Decay  
 β- 100 %  
 Qα -3630.67 (415) keV  
 Qβ 1165.048 (4071) keV  
 Qec -2627.807 (6812) keV  
 Sn 6363.78 (423) keV  
 Sp 9646.63 (690) keV  
 Electric Moment +0.214 (7) barn  
 Magnetic Moment +0.9032 (7) barn  
 Binding/A 8398.503 (31) keV  
 Mass 134.907228 (4455) AMU  
 Decay Radiations  
 From β- decay

	Energy [keV]	Intensity %
β-	310.2 (16)	96 (4)
	173.3 (15)	3.11 (14)
	248.1 (16)	0.59 (3)
	26.9 (11)	0.123 (6)
	50.0 (12)	0.075 (5)
γ	249.794 (15)	90 (3)
	608.185 (15)	2.90 (13)
	407.99 (2)	0.358 (17)
	158.197 (18)	0.289 (14)
	358.39 (3)	0.221 (11)
X	30.9728 (3)	2.64 (13)
	30.6251 (3)	1.43 (7)

# Quelques bonnes lectures...

The screenshot shows the Nobelprize.org website. The header includes the logo, navigation links (Home, Nobel Prizes and Laureates, Nomination, Ceremonies, Alfred Nobel, Educational, Events), and utility links (Video, Podcast, About Us, Search). The main content area is titled "The Nobel Prize in Physics 1922" and "Niels Bohr". It features a portrait of Bohr, a "Share this" section with social media icons, and a "Niels Bohr - Facts" section. The facts section includes his full name, birth and death dates and locations, affiliation at the time of the award, and the prize motivation. A sidebar on the left provides navigation for "Nobel Prizes and Laureates" and "Physics Prizes" for the year 1922. On the right, there are three promotional banners: "The Age to Come", "2014 Nobel Prize Announcements", and "2013 Nobel Laureates".

**Nobelprize.org**  
The Official Web Site of the Nobel Prize

Home | Nobel Prizes and Laureates | Nomination | Ceremonies | Alfred Nobel | Educational | Events

Video | Podcast | About Us | Search

**Nobel Prizes and Laureates**  
Physics Prizes < 1922 >

► About the Nobel Prize in Physics 1922  
▼ Niels Bohr  
Facts  
Biographical  
Nobel Lecture  
Banquet Speech  
Documentary  
Photo Gallery  
Other Resources

All Nobel Prizes in Physics  
All Nobel Prizes in 1922

**The Nobel Prize in Physics 1922**  
Niels Bohr

Share this: 32

## Niels Bohr - Facts



**Niels Henrik David Bohr**

**Born:** 7 October 1885, Copenhagen, Denmark

**Died:** 18 November 1962, Copenhagen, Denmark

**Affiliation at the time of the award:** Copenhagen University, Copenhagen, Denmark

**Prize motivation:** "for his services in the investigation of the structure of atoms and of the radiation emanating from them"

**Field:** theoretical nuclear physics

**The Age to Come**  
New scientific and cultural perspectives on ageing  
Nobel Week Dialogue

**2014 Nobel Prize Announcements**

**2013 Nobel Laureates**  
© The Nobel Foundation. Photo: Lovisa Engblom.

- ❖ K. Krane, Introductory Nuclear Physics, J. Wiley & Sons
- ❖ L. Valentin, Physique Subatomique: noyaux & particules, Hermann
- ❖ R. Casten, Nuclear Structure from a Simple Perspective, Oxford Science Publications

# Part 1 - Introduction & Radioactivité

# Le Noyau

$Z$  protons,  $N$  neutrons

Nombre de masse  $A = Z + N$

Numéro atomique  $Z$

Charge du noyau  $+Ze$  ( $e = 1.6 \cdot 10^{-19}$  C)

Les nucléons sont des **fermions**: spin  $1/2$ , principe d'exclusion de Pauli

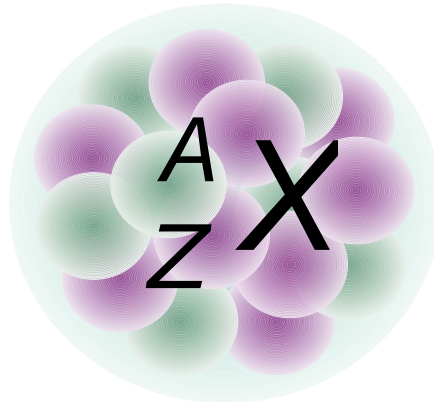

A nucléons en interaction



# Un système complexe

Comprendre et prédire l'organisation des nucléons  
au sein du noyau et les propriétés qui en découlent

=

Enjeu de la physique nucléaire

Résolution

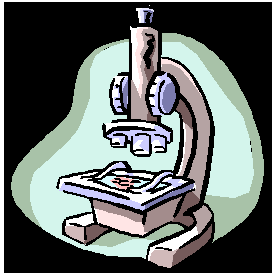

140  
masse du pion



baryons, mesons

8  
énergie de séparation  
d'1 proton dans le Plomb

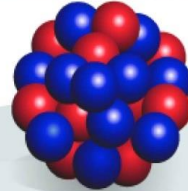

protons, neutrons

1.32  
énergie de vibration  
dans l'étain

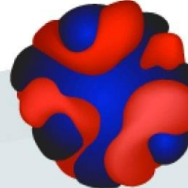

nucleonic densities  
and currents

0.043  
énergie de rotation  
dans l'Uranium



collective coordinates

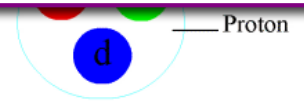

Proton

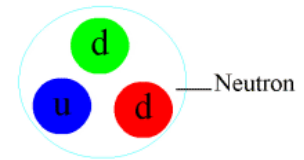

Neutron

Physique des Noyaux

# La Charte des Noyaux

3224 nucléides (2016)

288 stables (= dont la durée de vie est plus grande que l'âge du système solaire)

Isotope: même Z (même élément chimique), N différent

Isotone: même N, Z différent

Isobar: même A, Z&N différents

**alpha** émission d' $^4\text{He}$

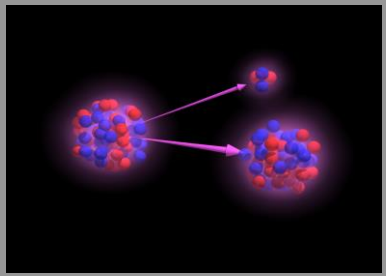

**radioactivité proton**  
noyau  $\rightarrow$  proton + (noyau - 1 proton)

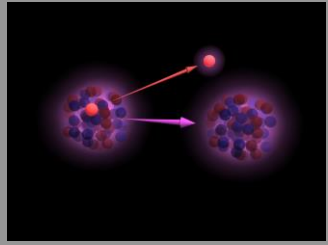

**beta +** proton  $\rightarrow$  neutron +  $e^+$  +  $\bar{\nu}_e$

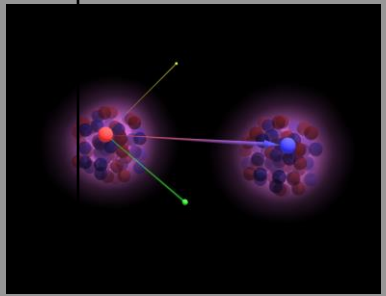

**fission** cassure du noyau

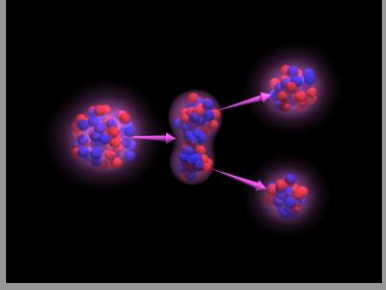

**beta -** neutron  $\rightarrow$  proton +  $e^-$  +  $\bar{\nu}_e$

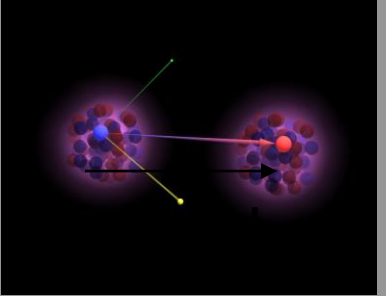

**Gamma** relaxation nucléaire + photon  $\gamma$

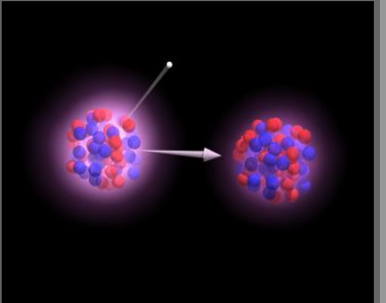
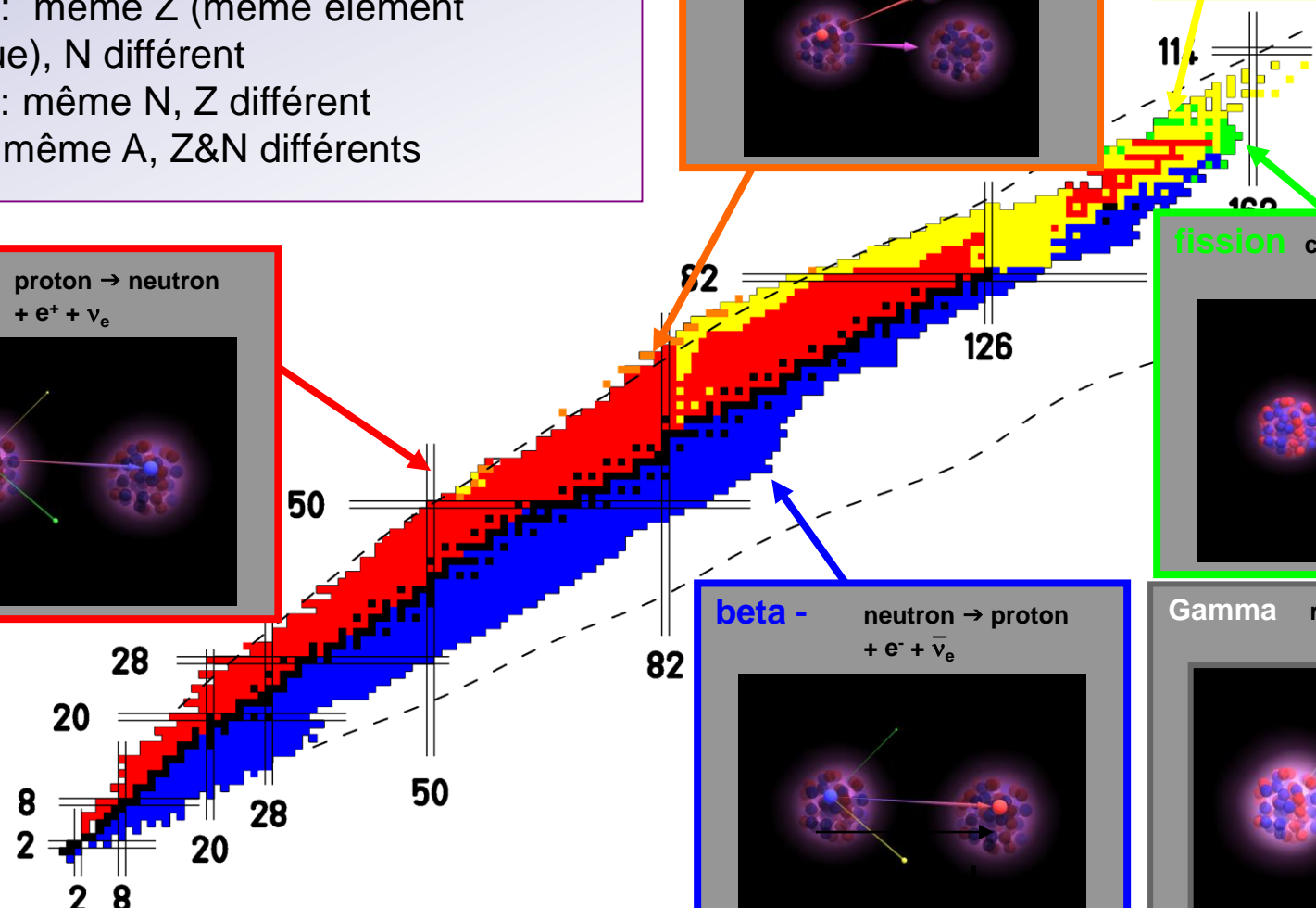



prédiction: ~7000 nucléides liés

# Découverte de Nouveaux Isotopes

T. Ohnishi et al. , J. Phys. Soc. Jpn. 79 (2010) 073201  
 D. Kameda et al.: Phys. Rev. C 86 (2012) 054319

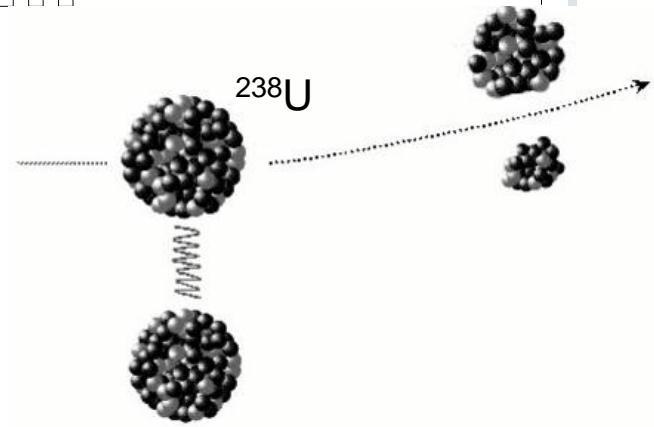
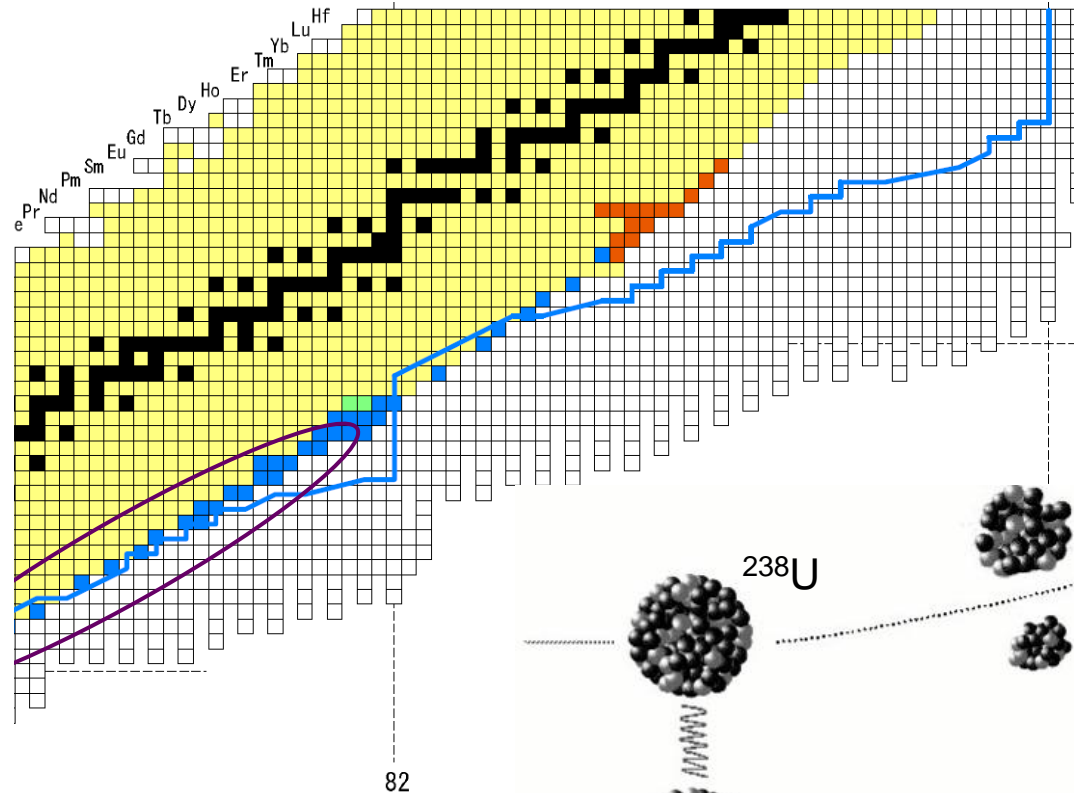
Rank	Country	Isotopes
1	USA	1328
2	Germany	559
3	UK	299
4	Russia	249
5	France	220
6	Japan	150
7	Switzerland	127
8	Canada	66
9	Sweden	59
10	Finland	40
11	Netherlands	36
12	China	29
13	Belgium	17
14	Denmark	13
	Argentina	13
16	Italy	11
17	Israel	6
18	Austria	5
19	India	2
	Norway	2
	Australia	2
22	New Zealand	1
	Brazil	1
	Poland	1
	Hungary	1



<https://people.nslc.msu.edu/~thoennes/isotopes/>

2007, 2008, 2011 ( $^{238}\text{U}$ ): 61 nouveaux isotopes    2014-2015 ( $^{238}\text{U}$ ): 13 nouveaux isotopes  
 2011 ( $^{124}\text{Xe}$ ): 4 nouveaux isotopes    2016 ( $^{124}\text{Xe}$ ): 4 nouveaux isotopes

# Synthèse de Nouveaux Eléments

Ion lourd  
accéléré

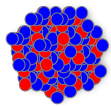

Atome  
d'actinide

fusion

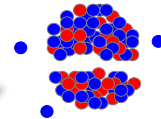
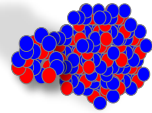

fission

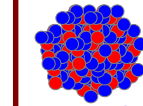

fusion-  
évaporation

$\sigma \sim 1-10 \text{ pb} !$

Faisceau intense  
d'ions lourds

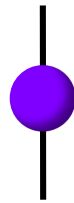

Cible  
rotative

Filtre

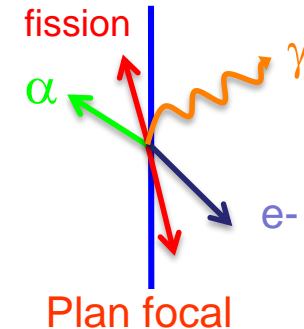

# Eléments Super Lourds



28/11/2016: IUPAC approuve les noms des 4 nouveaux éléments!

30/12/2015: IUPAC annonce que la 7<sup>ème</sup> période du tableau périodique est complète!

37	Ru	38	Sr	39	Y	40	Zr	41	Ni	42	Mo	43	Tc	44	Ru	45	Rh	46	Pd	47	Ag	48	Cd	49	Ind	50	Ti	51	Ant	52	Tl	53	I	54	Xe
Cs	Ba	La	Hf	Ta	W	Re	Os	Ir	Pt	Au	Hg	Ti	Pb	Bi	Po	At	Rn																		
55	56	57	72	73	74	75	76	77	78	79	80	81	82	83	84	85	86																		
Fr	Ra	Ac	Rf	Db	Sg	Bh	Hs	Mt	Ds	Rg	Cn	Nb	Fl	Mt	Lv	Ts	Og																		
87	88	89	104	105	106	107	108	109	110	111	112	113	114	115	116	117	118																		
La	Ce	Pr	Nd	Pm	Sm	Eu	Gd	Tb	Dy	Ho	Er	Tm	Yb	Lu																					
57	58	59	60	61	62	63	64	65	66	67	68	69	70	71																					
Ac	Th	Pa	U	Np	Pu	Am	Cm	Bk	Cf	Es	Fm	Md	No	Lr																					
89	90	91	92	93	94	95	96	97	98	99	100	101	102	103																					

# Découverte de nouvelles radioactivités

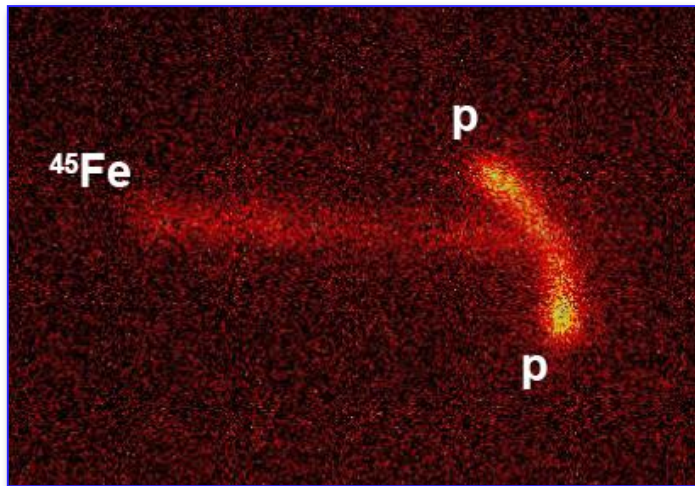
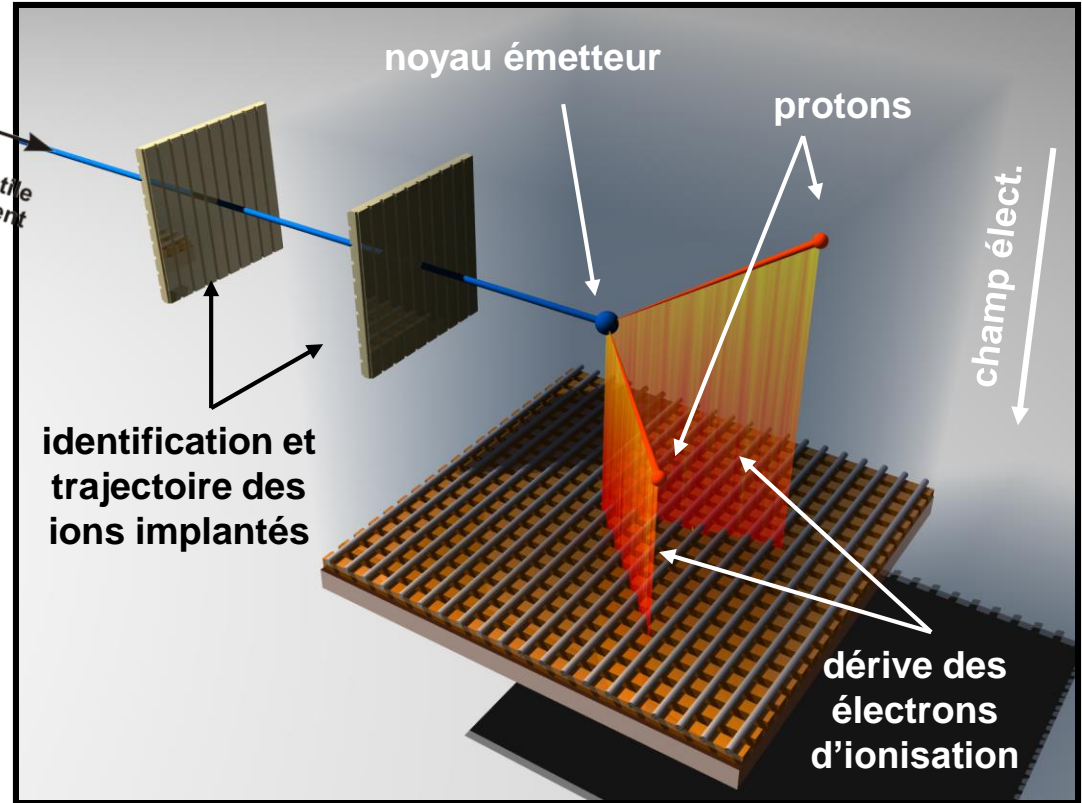
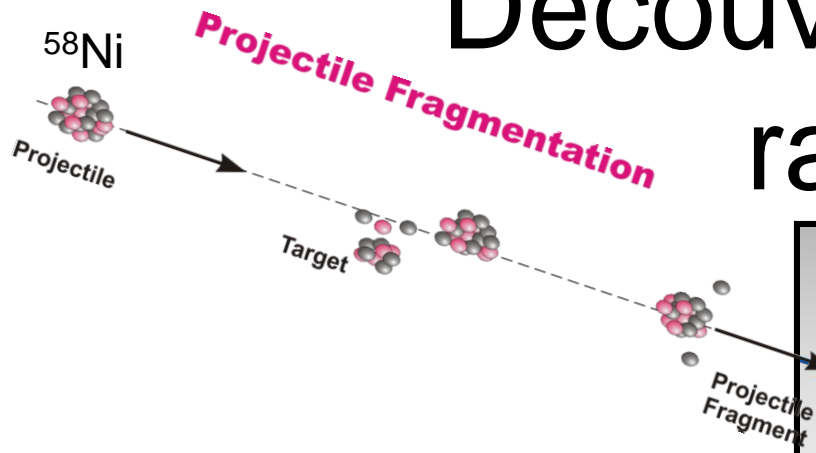

J. Giovinazzo et al., Phys. Rev. Lett. 89, 102501 (2002)  
M. Pfützner et al., Eur. Phys. J. A14, 279 (2002)  
K. Miernik et al., Phys. Rev. Lett. 99, 192501 (2007)

2 autres cas observés depuis:  $^{54}\text{Zn}$  et  $^{48}\text{Ni}$

3 autres cas potentiels synthétisés pour la 1<sup>ère</sup> fois au RIKEN:  $^{59}\text{Ge}$ ,  $^{63}\text{Se}$  et  $^{67}\text{Kr}$

B. Blank et al., Phys. Rev. C 93, 061301(R) (2016)



# Il y a ~106 ans.....

*“ The scattering of  $\alpha$  and  $\beta$  particles by matter and the structure of the atom”*

*Philosophical Magazine Series 6,  
vol. 21 May 1911, p. 669-688*

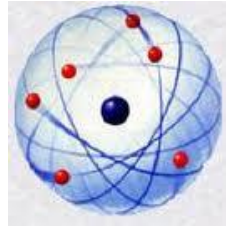

Le prix Nobel de Chimie 1911 est attribué à Marie Curie

*“ en reconnaissance des services pour l'avancement de la chimie par la découverte de nouveaux éléments : le radium et le polonium, par l'étude de leur nature et de leurs composés ”*



# A l'aube du 20<sup>ème</sup> siècle



“Désormais, il n’y a plus rien de nouveau à découvrir en physique. Ce qui reste à faire, ce sont des mesures de plus en plus précises.”

William Thomson (Lord Kelvin), 1900  
British Association for the advancement of Science



# Composition de la matière

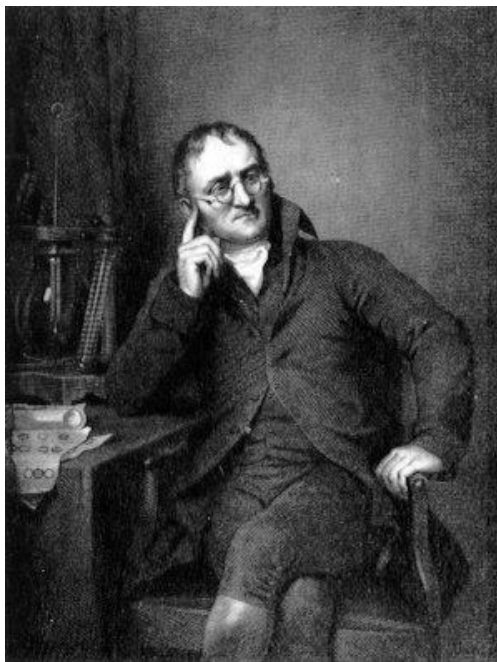

John Dalton

1803 :

-La matière est faite de d'**atomes**  
(du grec ατομος = indivisible)

-Les atomes d'un même élément  
sont identiques

-Les atomes d'un élément peuvent se combiner à  
ceux d'un autre pour former un composé chimique

-Les atomes d'éléments différents ont des masses  
différentes



# Classification des éléments

**Périodicité** des propriétés chimiques des éléments

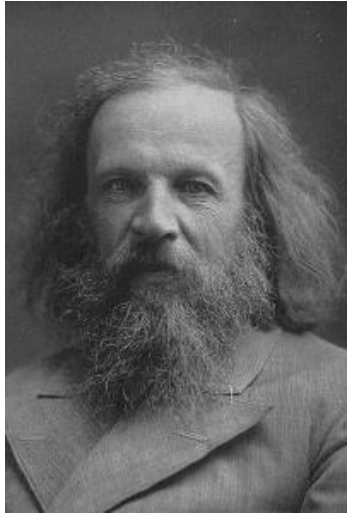

Dmitri Ivanovich  
Mendeleev

ОПЫТЪ СИСТЕМЫ ЭЛЕМЕНТОВЪ.

ОСНОВАННОЙ НА ИХЪ АТОМНОМЪ ВѢСѢ И ХИМИЧЕСКОМЪ СХОДСТВѢ.

		Ti = 50	Zr = 90	? = 180.	
		V = 51	Nb = 94	Ta = 182.	
		Cr = 52	Mo = 96	W = 186.	
		Mn = 55	Rh = 104,4	Pt = 197,1.	
		Fe = 56	Rn = 104,4	Ir = 198.	
		Ni = Co = 59	Pl = 106,6	Os = 199.	
H = 1		Cu = 63,4	Ag = 108	Hg = 200.	
	Be = 9,1	Mg = 24	Zn = 65,2	Cd = 112	
	B = 11	Al = 27,9	Ga? = 68	Ur = 116	Au = 197?
	C = 12	Si = 28,1	Ge? = 70	Sn = 118	
	N = 14	P = 31	As = 75	Sb = 122	Bi = 210?
	O = 16	S = 32	Se = 79,4	Te = 128?	
	F = 19	Cl = 35,5	Br = 80	I = 127	
Li = 7	Na = 23	K = 39	Rb = 85,4	Cs = 133	Tl = 204.
		Ca = 40	Sr = 87,6	Ba = 137	Pb = 207.
		Sc? = 45	Ce = 92		
		?Er = 56	La = 94		
		?Yt = 60	Di = 95		
		?In = 75,6	Th = 118?		

L'emplacement dans le tableau est donné par **Z** (= numéro atomique, de AtomZahl)

# Quelques nuages dans le ciel de la physique théorique....



Max Planck

La catastrophe ultraviolette: Répartition spectrale du rayonnement thermique des corps

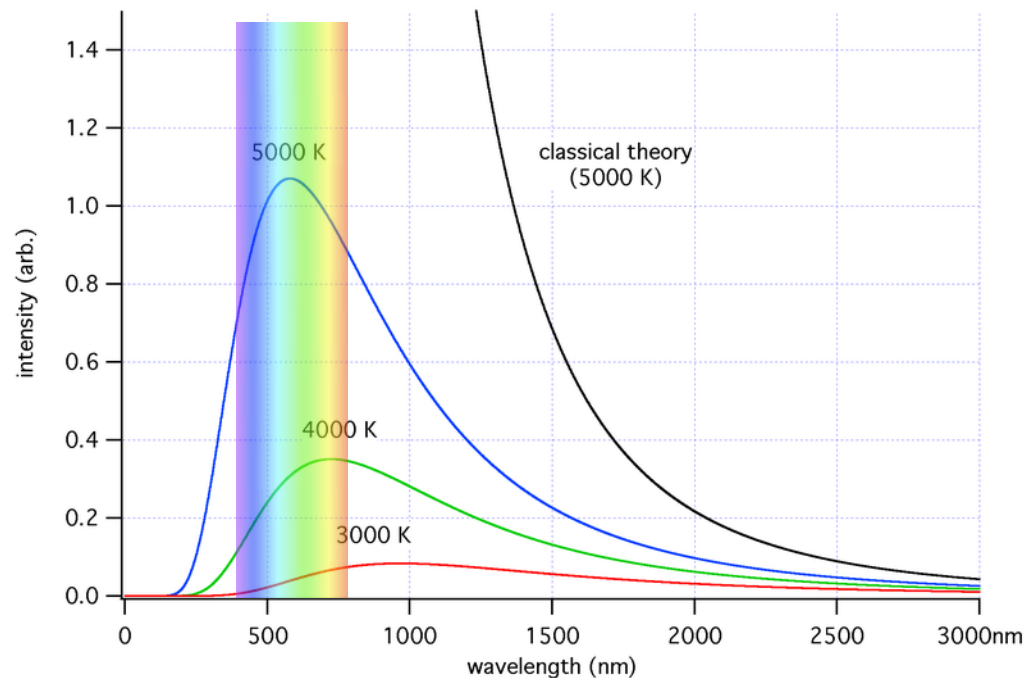

La matière ne peut absorber ou émettre d'énergie lumineuse que par paquets finis proportionnels à la fréquence de la lumière, les **quanta** d'énergie

Selon A. Einstein la discontinuité de Planck provient de la structure granulaire de la lumière: la lumière est composée de **quantas lumineux = photons**

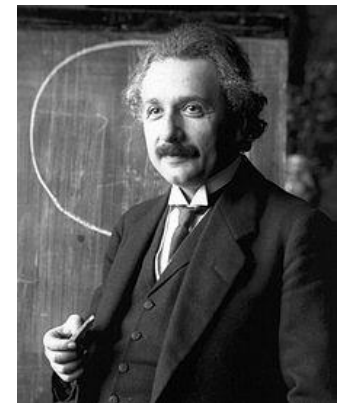

Albert Einstein



# L'éther

La lumière doit se propager dans un milieu: l'éther  
La vitesse de la lumière  $c$  obtenue à partir des équations de Maxwell est celle mesurée par rapport à l'éther

⇒ tout objet en mouvement par rapport à l'éther doit donc mesurer une vitesse de la lumière différente

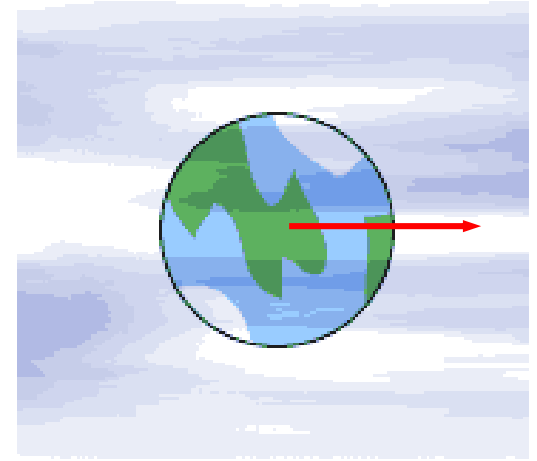

1887: échec de l'expérience d'interférométrie de Michelson-Morley

A. Einstein réconcilie la mécanique de I. Newton avec l'électromagnétisme de J.C. Maxwell en énonçant la théorie de la relativité restreinte

$$E = mc^2$$

# La révolution du tube cathodique

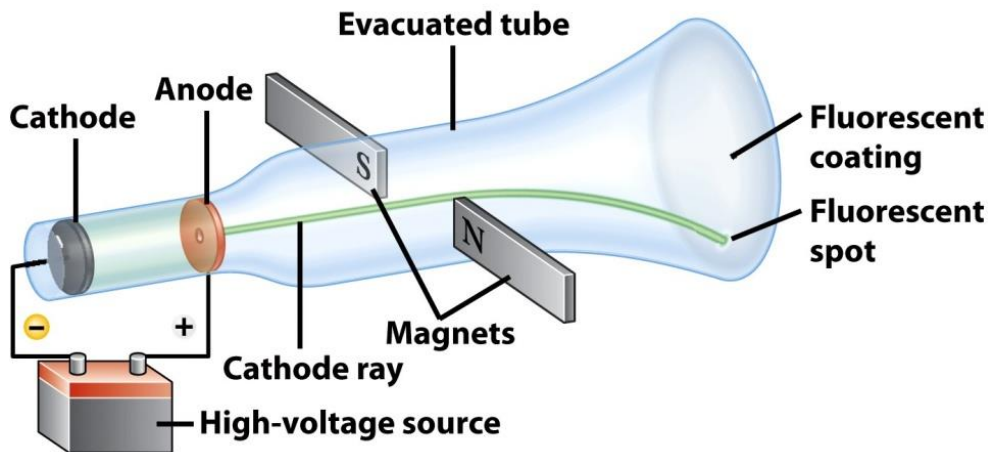
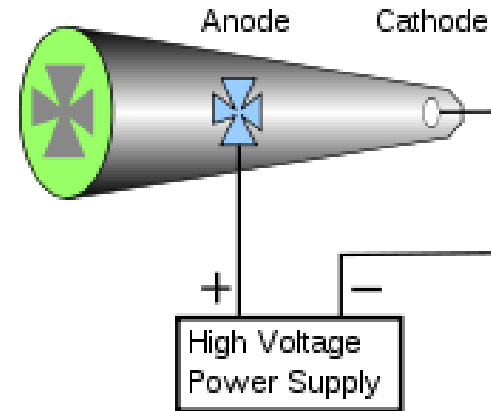

1895: Jean Perrin démontre que les rayons cathodiques sont des particules chargées négativement

# Les corpuscules

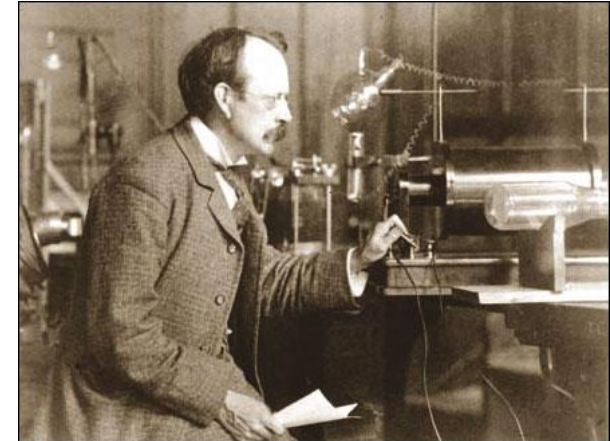
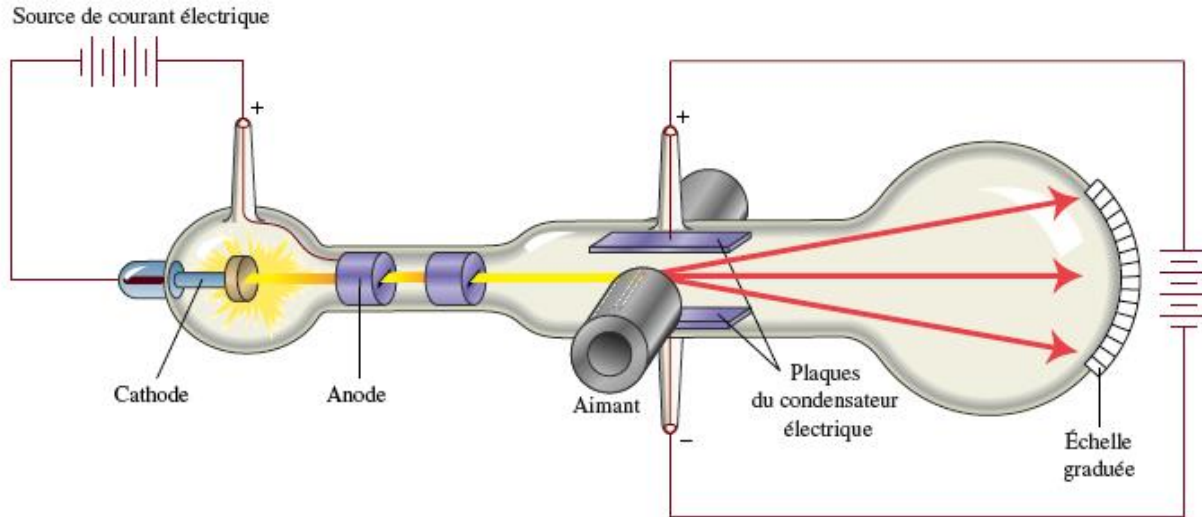

John Joseph Thomson

J.J. Thomson mesure le rapport charge/masse des particules composant les rayons cathodiques et ce rapport ne varie pas quels que soient les matériaux/gaz utilisés

1898: J.J. Thomson en conclut que ces 'corpuscules' sont les constituants des atomes (qui ne sont donc pas indivisibles !)

*Modèle 'plum pudding'*

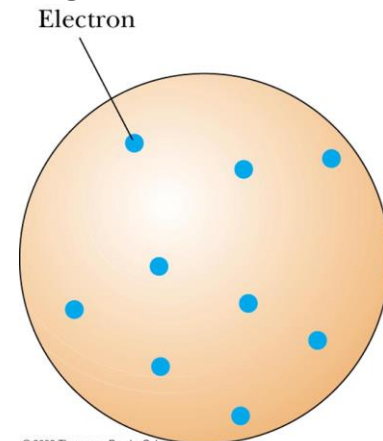



# Des rayons cathodiques aux rayons X

1895 W. Röntgen

découverte des rayons X



Wilhelm Röntgen

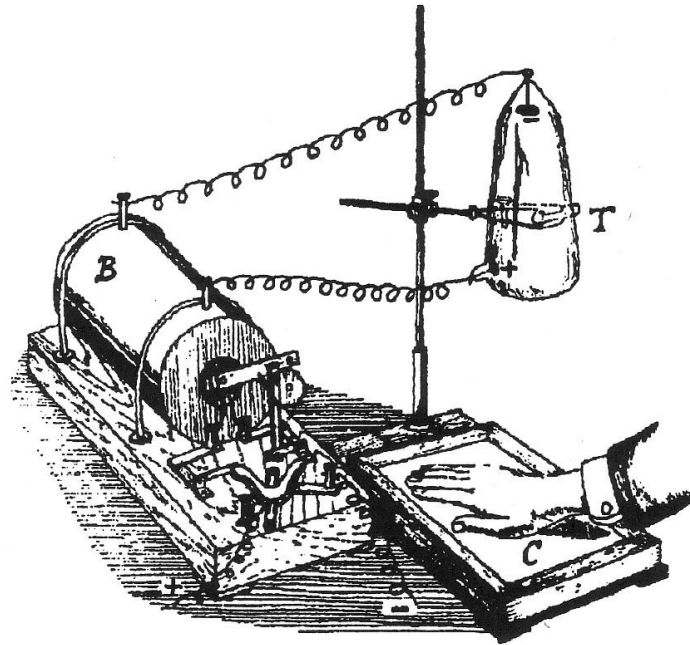

W. Röntgen reçoit le 1<sup>er</sup> prix Nobel de Physique en 1901



# Des rayons X aux rayons uraniques

1896 H. Becquerel

découverte d'un nouveau rayonnement émis par l'Uranium



Henri Becquerel

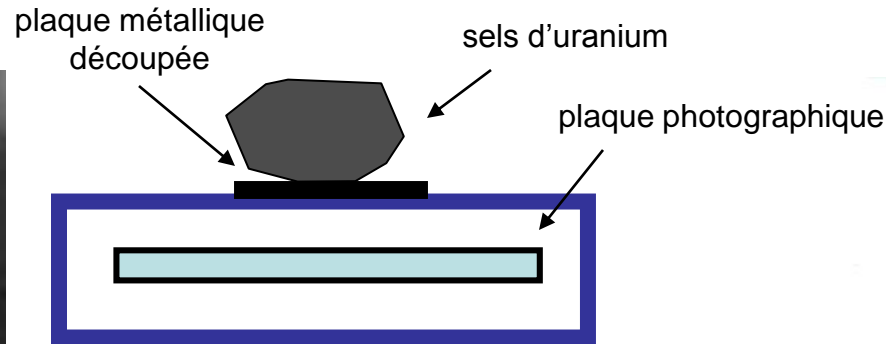

40 - 17000 g6. Sulfate double d'uranyle et de Potasse  
Papier noir. Couvré de la même manière.  
Exposé au soleil le 27. et dans le noir depuis le 28. -  
Ninifeux le 1<sup>er</sup> mars.

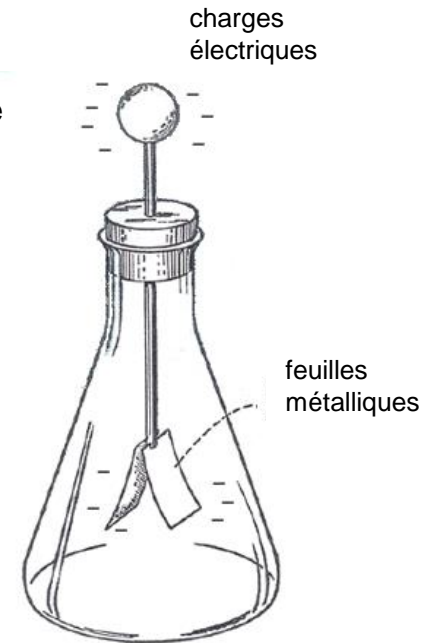
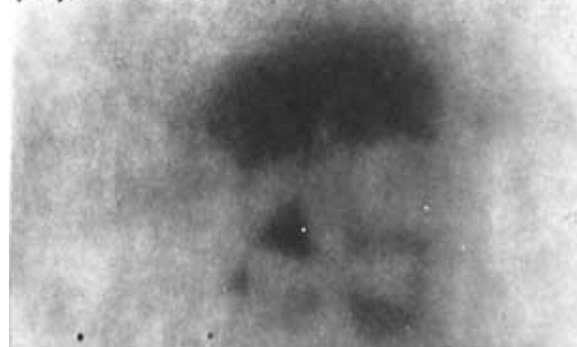

Les rayons uraniques ionisent l'air et provoquent la décharge d'un électroscope



# Des rayons uraniques à la radioactivité

1898 Marie & Pierre Curie



Marie Curie



Pierre Curie

extraction du polonium (dans la fraction de Bismuth) et du radium (fraction du Baryum)

M. Curie appelle le rayonnement:  
**'radioactivité'**



Laboratoire à l'Ecole de Physique et Chimie Industrielle de Paris

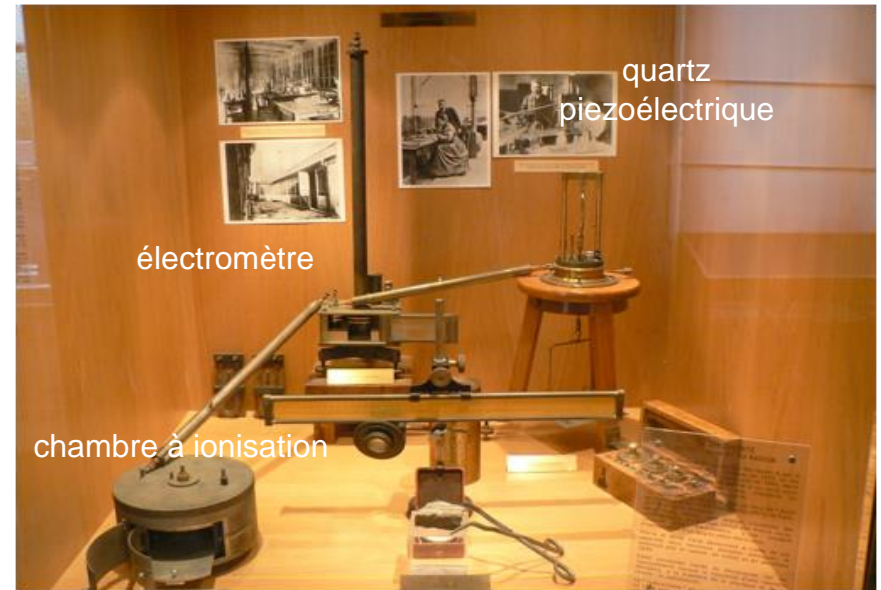

# La radioactivité est multiple

1898 E. Rutherford

rayonnement alpha, beta

1900 P. Villard

rayonnement gamma

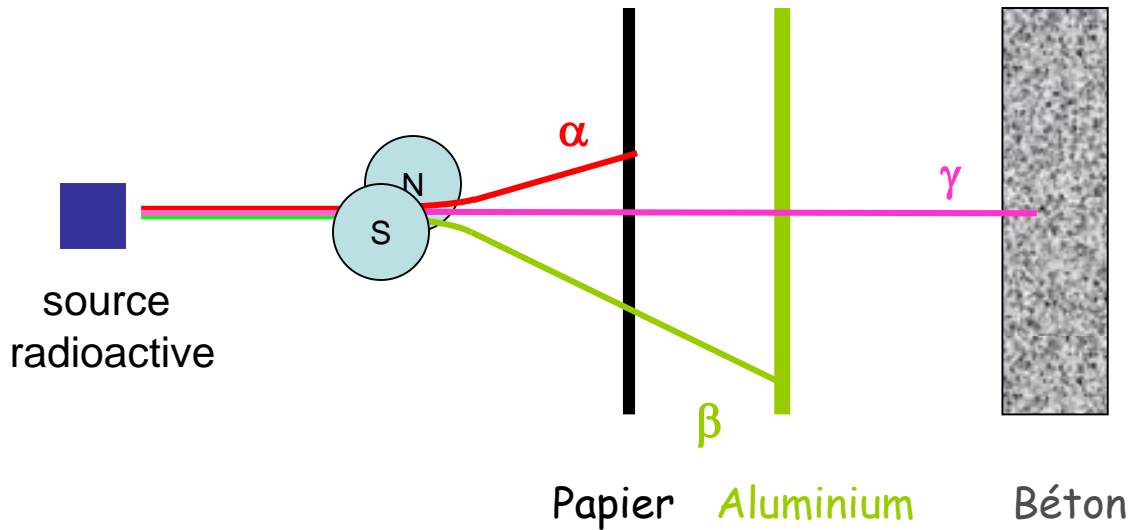

$\alpha$  = ion d'hélium  $\text{He}^{2+}$

$\beta$  =  $e^-$  de grande énergie

$\gamma$  = photons - comme les X



Ernest Rutherford



Paul Villard

# Les atomes se transforment !

1902 E. Rutherford & F. Soddy

transmutation des atomes

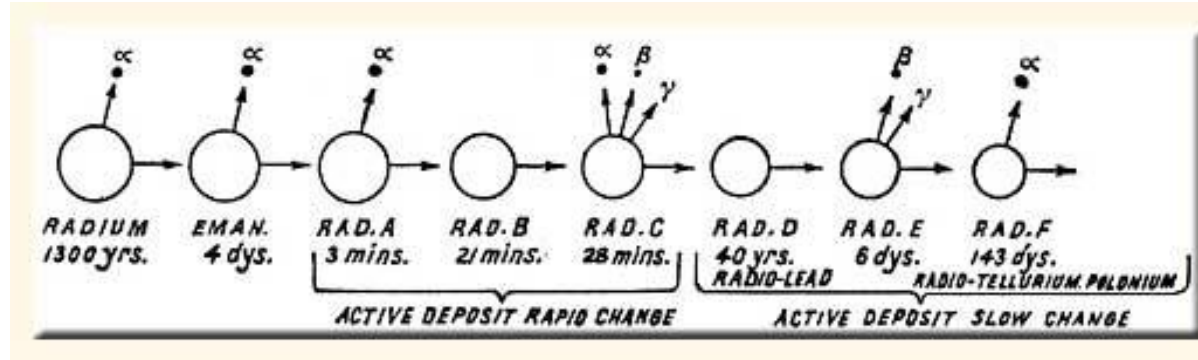
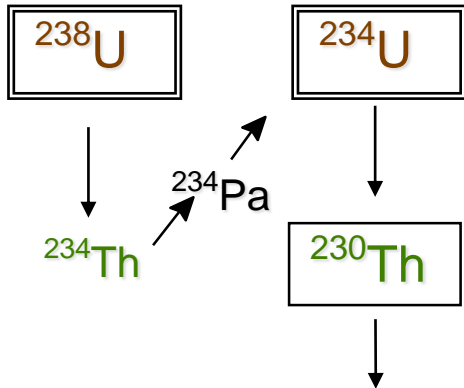

*Philosophical Transactions of the Royal Society of London, 1905*

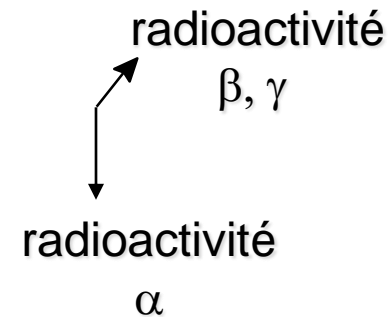
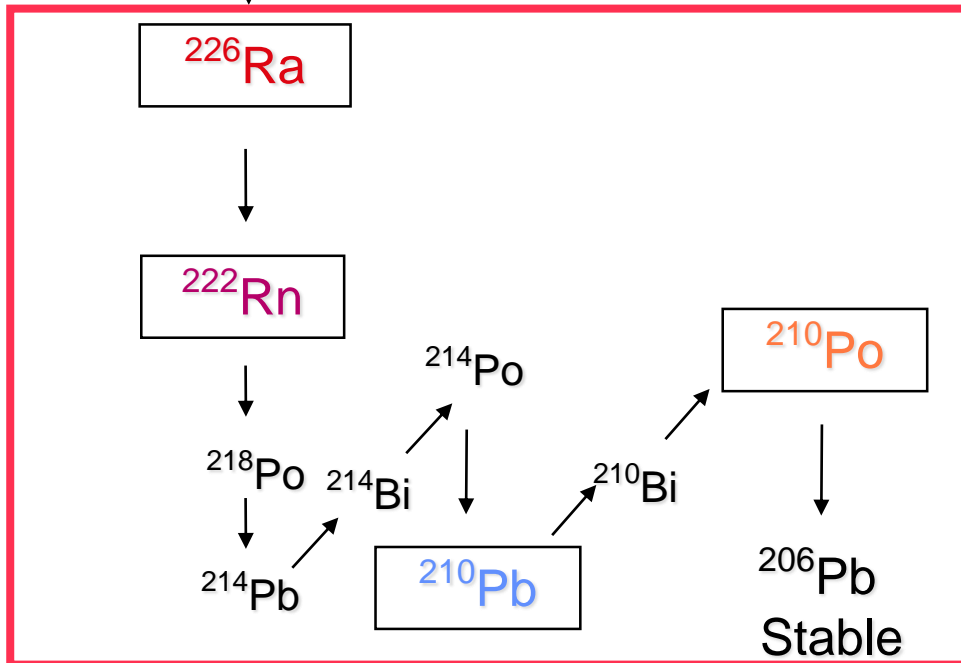

# Décroissance radioactive

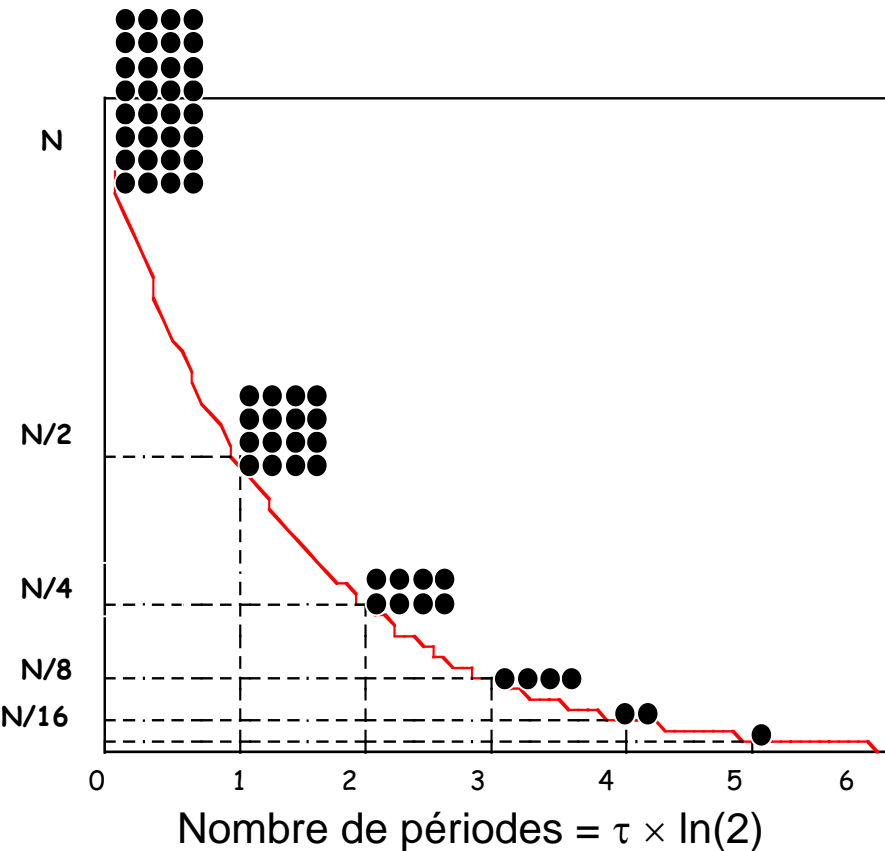

Nombre de  
noyaux  
au temps t

Nombre initial  
de noyaux

Constante de  
décroissance

$$N(t) = N_0 \exp(-t/\tau)$$

$$\text{Activité} = \lambda N(t) = N(t)/\tau$$

Durée de vie

## Quelques exemples d'activités :

Homme : 130 Bq/kg

Maison en granit: 4 milliards de Bq

Béton: 500 Bq/kg

Lait: 80 Bq/kg

Scintigraphie thyroïdienne: 37 millions de Bq

Combustible usé de réacteur: 10 milliards de  
milliards de Bq

## 1910:

1 curie (Ci) = activité d'1g de Radium

1 Ci = 37 milliards de désintégrations/s

1 Bq = 1 désintégration/s

# Loi de décroissance exponentielle



A LETTERS JOURNAL EXPLORING  
THE FRONTIERS OF PHYSICS

March 2012

EPL, **97** (2012) 52001  
doi: 10.1209/0295-5075/97/52001

[www.epljournal.org](http://www.epljournal.org)

## Is radioactive decay really exponential?

P. J. ASTON<sup>(a)</sup>

*Department of Mathematics, University of Surrey - Guildford, Surrey GU2 7XH, UK*

received 30 November 2011; accepted in final form 25 January 2012  
published online 28 February 2012

PACS 23.90.+w – Other topics in radioactive decay and in-beam spectroscopy  
PACS 03.65.Sq – Quantum mechanics: Semiclassical theories and application  
PACS 02.30.Hq – Mathematical methods in physics: Ordinary differential equations

**Abstract** – Radioactive decay of an unstable isotope is widely believed to be exponential. This view is supported by experiments on rapidly decaying isotopes but is more difficult to verify for slowly decaying isotopes. The decay of  $^{14}\text{C}$  can be calibrated over a period of 12550 years by comparing radiocarbon dates with dates obtained from dendrochronology. It is well known that this approach shows that radiocarbon dates of over 3000 years are in error, which is generally attributed to past variation in atmospheric levels of  $^{14}\text{C}$ . We note that predicted atmospheric variation (assuming exponential decay) does not agree with results from modelling, and that theoretical quantum mechanics does not predict exact exponential decay. We give mathematical arguments that non-exponential decay should be expected for slowly decaying isotopes and explore the consequences of non-exponential decay. We propose an experimental test of this prediction of non-exponential decay for  $^{14}\text{C}$ . If confirmed, a foundation stone of current dating methods will have been removed, requiring a radical reappraisal both of radioisotope dating methods and of currently predicted dates obtained using these methods.

# Présence de Th et U sur terre

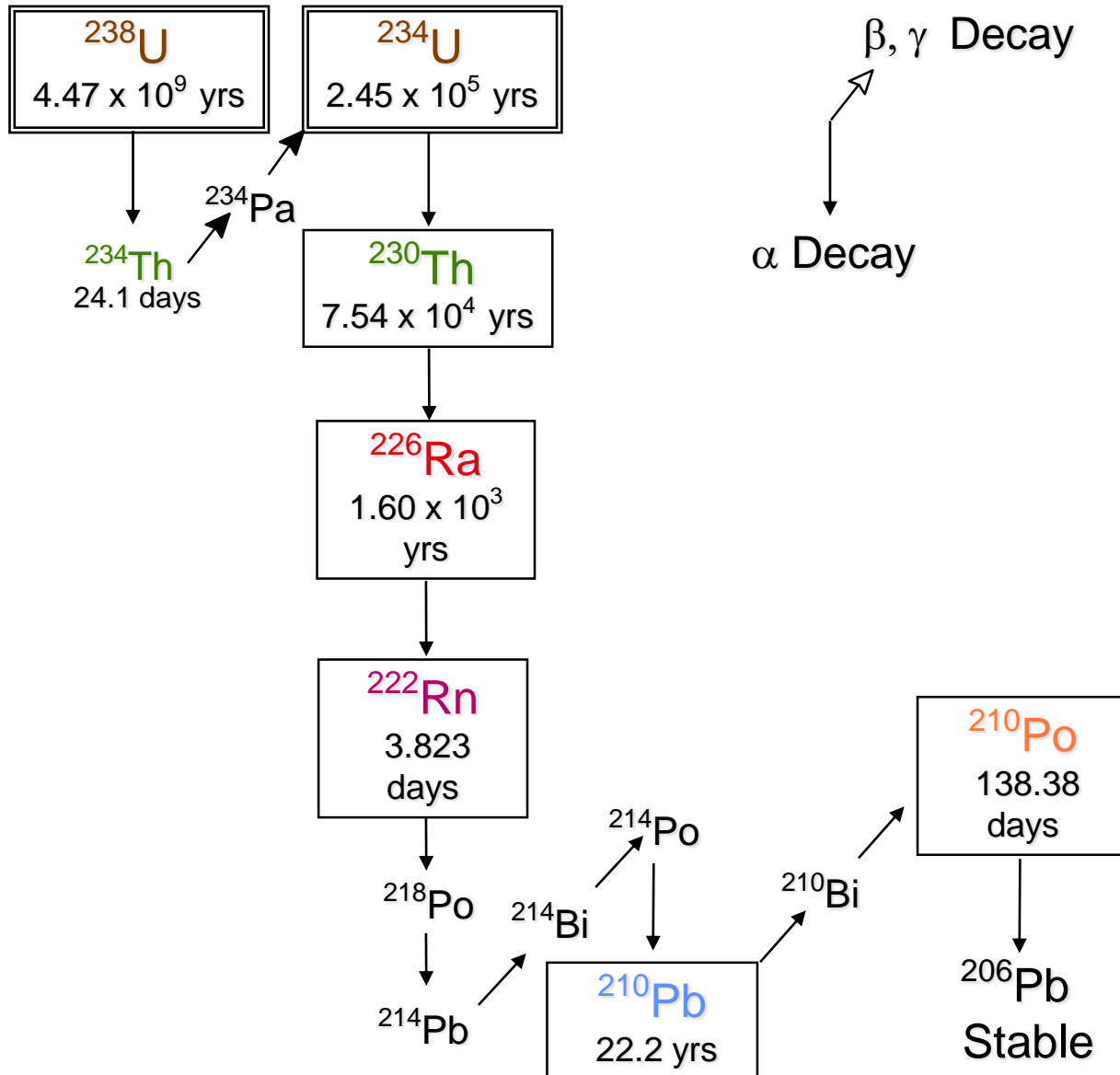

Age de la terre:  
 $\sim 4.5 \times 10^9$  années

Demi-vie:  
 $^{232}\text{Th}$ :  $1.40 \times 10^{10}$  a

$^{234}\text{U}$ :  $2.45 \times 10^5$  a

$^{235}\text{U}$ :  $7.04 \times 10^8$  a

$^{238}\text{U}$ :  $4.47 \times 10^9$  a



# Radioactivité "ambiante"

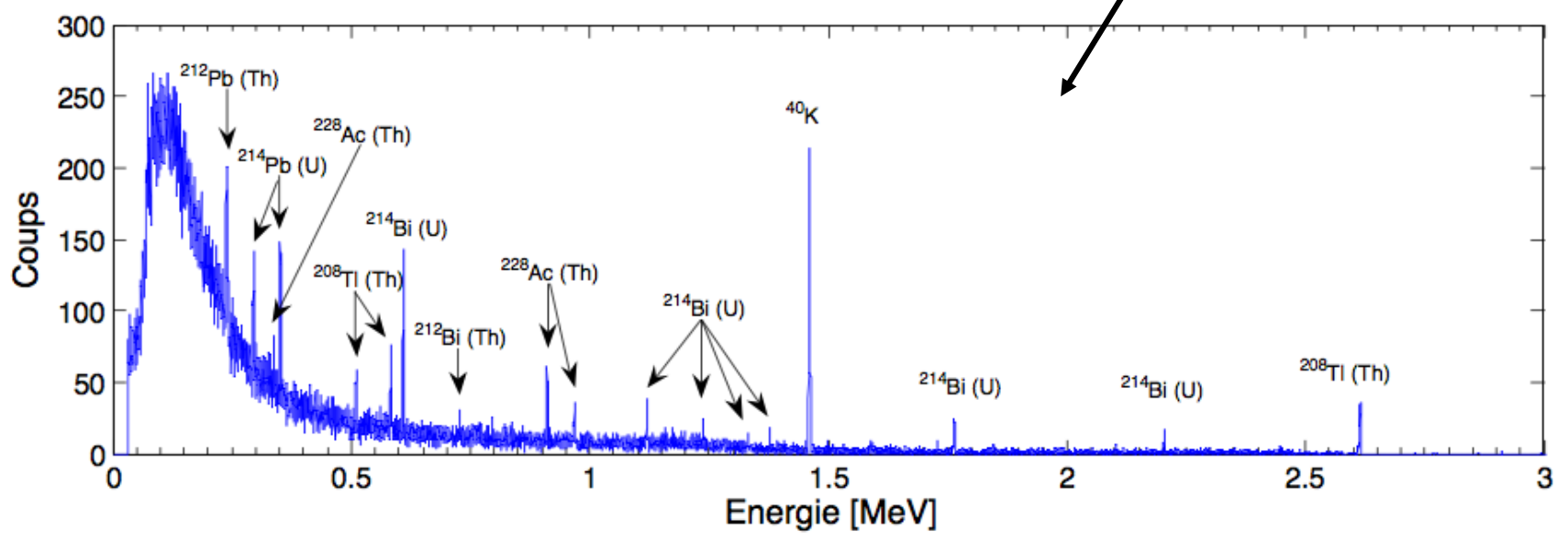

# Radioactivité et Energie

1903: Pierre Curie et son collaborateur Albert Laborde annoncent que le radium dégage en permanence tant de chaleur qu'il peut faire fondre plus que son poids de glace en 1 heure.

## D'où vient l'énergie des rayonnements ?

« Il y a tout lieu de croire que les atomes des éléments radioactifs renferment une énorme quantité d'énergie latente... Si on parvenait à contrôler la vitesse à laquelle se désintègrent ces éléments, une petite quantité de matière libèrerait une masse colossale d'énergie. »

'Radioactivity', E. Rutherford, Ed. Cambridge at the University Press (1904)

1914: H.G. Wells publie "The world set free" ("La destruction libératrice")



# Energie et l'âge de la terre

## Lord Kelvin:

- ~dizaines de millions d'années
- refroidissement à partir d'un état initialement fondu
- arguments quantitatifs

## Géologues and Biologistes:

- ~centaines de millions d'années
- fossiles, évolution, vitesse de sédimentation....
- arguments "qualitatifs"

## Découverte de la radioactivité :

- la désintégration des minerais radioactifs contenus dans la terre est une source de chaleur (ce qui contribue à invalider les calculs de Kelvin - en plus du fait que ce dernier n'avait pas pris en compte la convection)

**Flux de chaleur terrestre:  $44.2 \pm 1.0$  TW**  
**Contribution due au noyaux radioactifs**  
**d' $^{238}\text{U}$ ,  $^{232}\text{Th}$  et  $^{40}\text{K}$ : ~50%**

Nature Geoscience 4 (2011) 647



# Géochronologie

## Découverte de la radioactivité :

■ la radioactivité fournit une horloge capable de donner un âge absolu à la Terre

Radioactive Parent	Stable Daughter Product	Currently Accepted Half-life Values
Uranium-238	Lead-206	4.5 billion years
Uranium-235	Lead-207	713 million years
Thorium-232	Lead-208	14.1 billion years
Rubidium-87	Strontium-87	47.0 billion years
Potassium-40	Argon-40	1.3 billion years

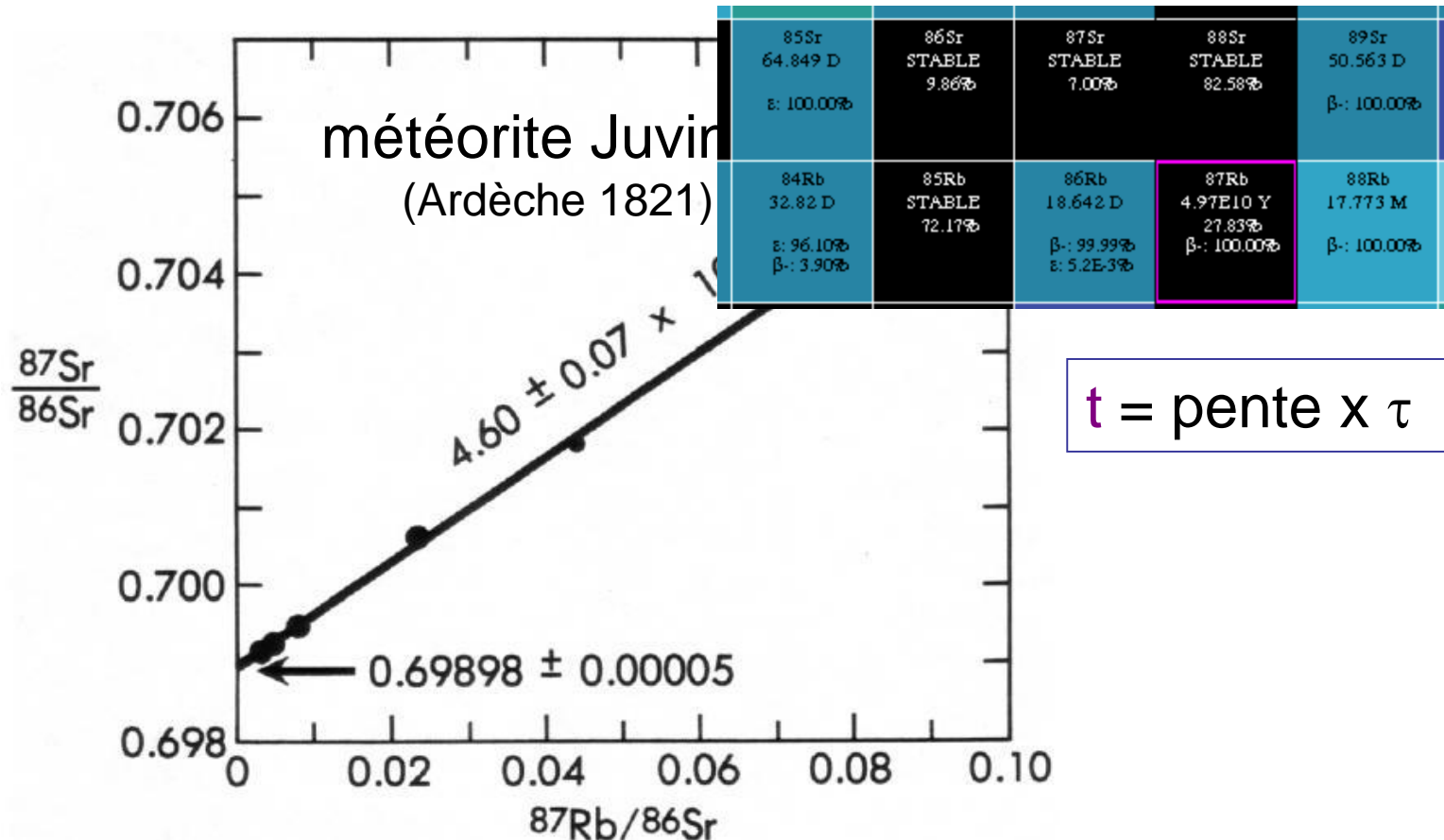

$$t = \text{pente} \times \tau$$

# La datation au $^{14}\text{C}$

1949: W. Libby mesure la 1/2 vie du  $^{14}\text{C}$  :  $5568 \pm 30$  ans  
 (maintenant  $t_{1/2} = 5730 \pm 40$  ans)

Cosmic rays produce neutrons

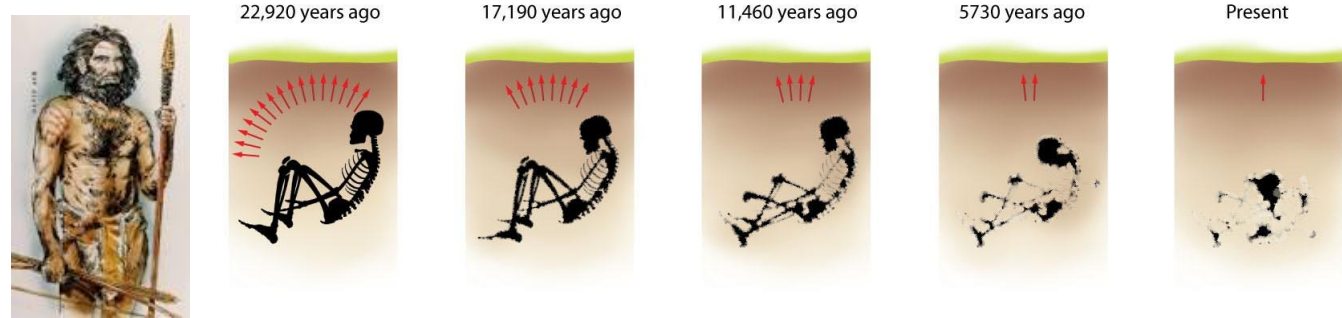
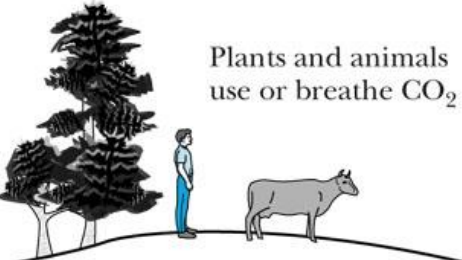
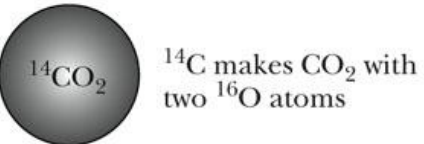
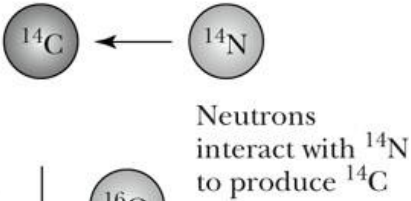
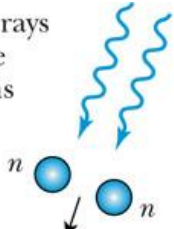

Le rapport  $^{14}\text{C}/^{12}\text{C}$  de l'atmosphère est sujet à des variations

$^{14}\text{C}/^{12}\text{C} = 1,3 \times 10^{-12}$

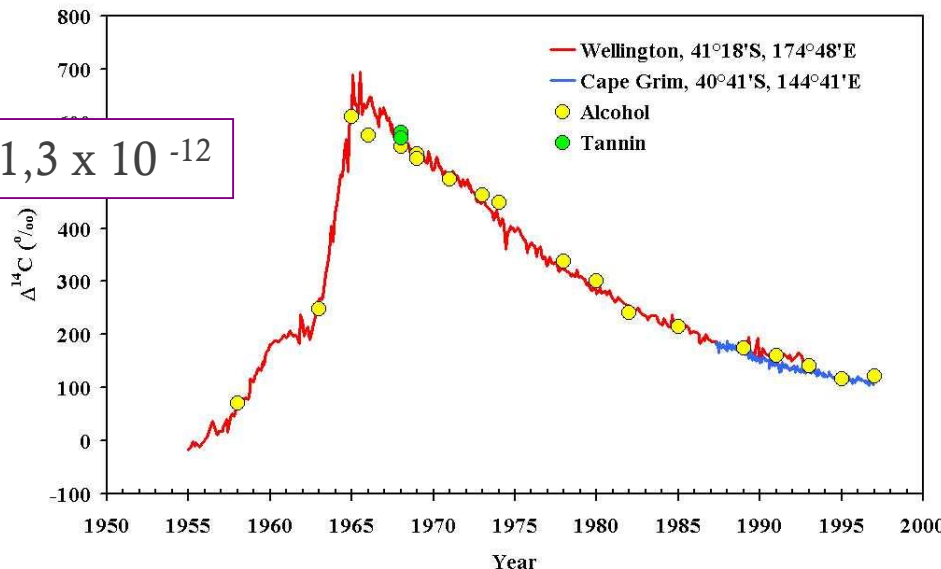

# Ötzi, l'homme des glaces



En septembre 1991, des randonneurs découvrent Ötzi (Iceman) dans les Alpes Italiennes.

Une activité 0,121 Bq pour 1 g de C a été mesurée



$t = 4546$  années



La découverte de la radioactivité a bouleversé la science et la société de façon générale et durable.

Mais les choses ne sont pas arrêtées là.....



# La diffusion de particules alpha

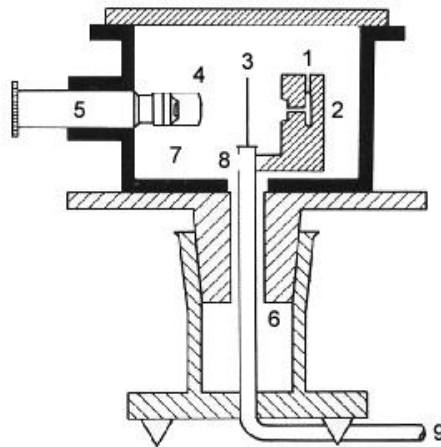
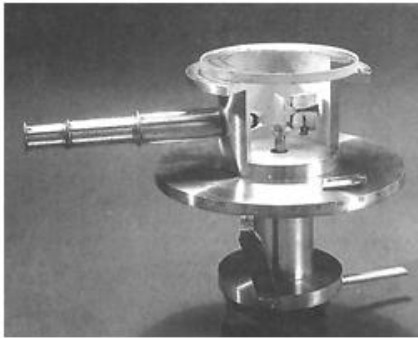

## The Rutherford Experiment

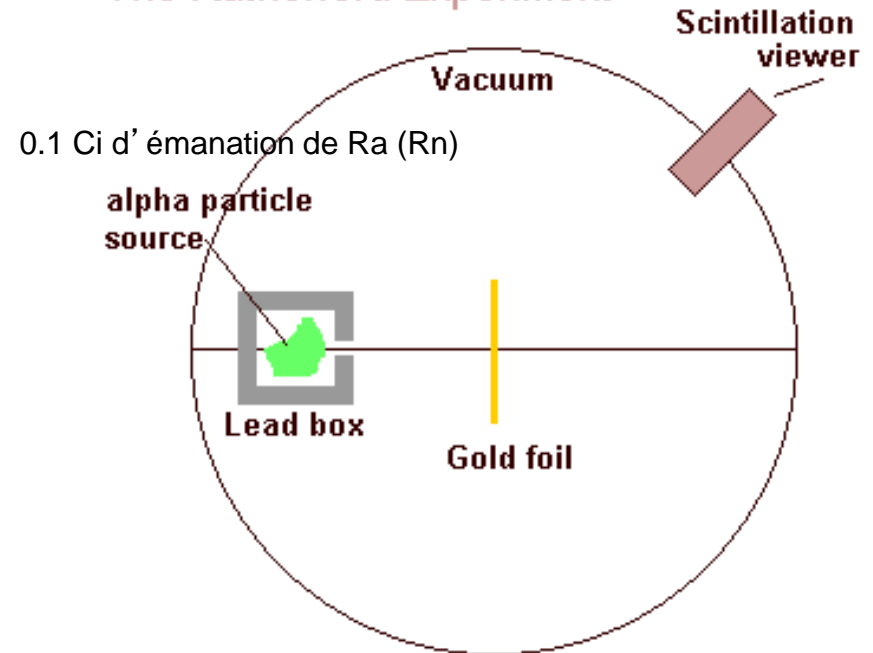

Expérience réalisée par H. Geiger et E. Marsden  
(1909, Université de Manchester)

©1999 Science Joy Wagon

« C'est aussi peu croyable que si nous avions tiré un obus sur du papier de soie et que l'obus nous soit revenu en pleine figure ! »

# Le noyau est né !

Modèle 'plum pudding'

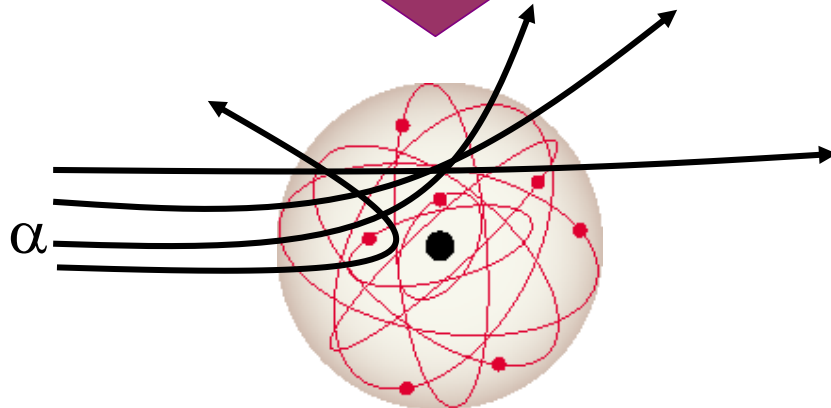
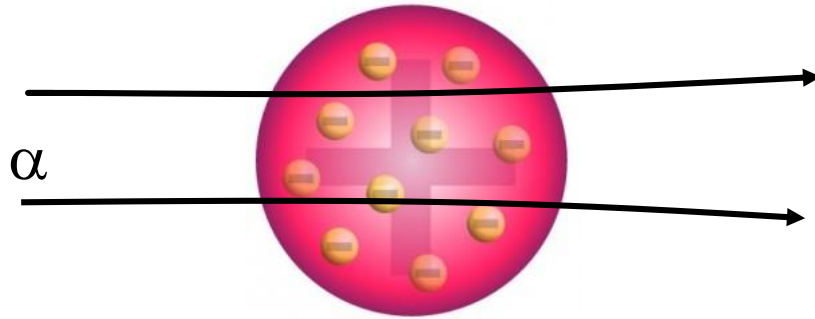

Modèle nucléaire

*Philosophical Magazine Series 6,*  
vol. 21 May 1911, p. 669-688

